

# High-Bandwidth, Quad DPDT Switches

## General Description

The MAX4760/MAX4760A/MAX4761/MAX4761A (DPDT) analog switches operate from a single +1.8V to +5.5V supply. These switches feature a low 54pF (typ) capacitance for high-speed data switching applications.

The MAX4760/MAX4760A are quad double-pole/double-throw (DPDT) switches, and the MAX4761/MAX4761A are octal single-pole/double-throw (SPDT) switches. They have eight 2.0Ω (typ) on-resistance, low-capacitance switches to route audio and data signals. The MAX4760/MAX4760A have four logic inputs to control the switches in pairs. The MAX4761/MAX4761A have one logic control input and an enable input (EN) to disable the switches.

The MAX4760/MAX4760A/MAX4761/MAX4761A are available in a small 36-pin (6mm x 6mm) TQFN and 36-bump (3mm x 3mm) chip-scale package (UCSP™).

## Applications

USB Signal Switching      PDAs/Handheld Devices  
 Audio-Signal Switching      Notebook Computers  
 Cellular Phones

## Functional Diagrams

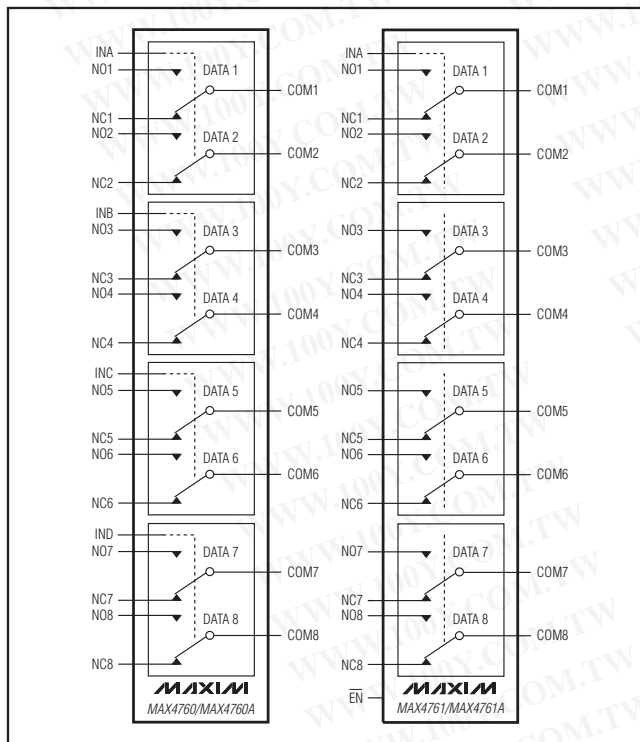

UCSP is a trademark of Maxim Integrated Products, Inc.

## Features

- ◆ USB 1.1 and USB 2.0 (Full Speed 12Mbps) Signal-Switching Compliant
- ◆ Data and Audio Signal Routing
- ◆ Low-Capacitance Data Switches
- ◆ Less than 0.2ns Skew
- ◆ -3dB Bandwidth: 150MHz (typ)
- ◆ 0.2Ω (typ) Channel-to-Channel Matching
- ◆ 0.8Ω (typ) On-Resistance Flatness
- ◆ Rail-to-Rail Signal Handling
- ◆ 0.03% (typ) THD
- ◆ +1.8V to +5.5V Supply Range
- ◆ Low Supply Current with 1.8V Logic Threshold (MAX4760A/MAX4761A)
- ◆ Tiny 36-Bump UCSP (3mm x 3mm)
- ◆ 36-Pin TQFN (6mm x 6mm)
- ◆ -40°C to +85°C Operating Temperature Range

## Ordering Information

| PART           | TEMP RANGE     | PIN-PACKAGE  |
|----------------|----------------|--------------|
| MAX4760EBX+T   | -40°C to +85°C | 36 UCSP      |
| MAX4760ETX+T   | -40°C to +85°C | 36 TQFN-EP** |
| MAX4760AEWX+T  | -40°C to +85°C | 36 UCSP      |
| MAX4760AETX+T* | -40°C to +85°C | 36 TQFN-EP** |
| MAX4761EBX+T   | -40°C to +85°C | 36 UCSP      |
| MAX4761ETX+T   | -40°C to +85°C | 36 TQFN-EP** |
| MAX4761AEBX+T* | -40°C to +85°C | 36 UCSP      |
| MAX4761AETX+T* | -40°C to +85°C | 36 TQFN-EP** |

\*Future product—contact factory for availability.

\*\*EP = Exposed Pad.

+ Denotes a lead(Pb)-free/RoHS-compliant package.

T = Tape and reel.

Pin Configurations/Truth Tables and Typical Operating Circuit appear at end of data sheet.

MAX4760/MAX4760A/MAX4761/MAX4761A

# High-Bandwidth, Quad DPDT Switches

## ABSOLUTE MAXIMUM RATINGS

(All voltages referenced to GND.)

|   |                           |
|---|---------------------------|
| V+  | .....-0.3V to +6V         |
| IN <sub>-</sub> , EN (MAX4761)                                | .....-0.3V to +6V         |
| IN <sub>-</sub> , EN (MAX4761A)                               | .....-0.3V to (V+ + 0.3V) |
| COM <sub>-</sub> , NO <sub>-</sub> , NC <sub>-</sub> (Note 1) | .....-0.3V to (V+ + 0.3V) |
| Continuous Current  |                           |
| NO <sub>-</sub> , NC <sub>-</sub> , COM <sub>-</sub>          | .....±100mA               |
| Peak Current  |                           |
| (pulsed at 1ms, 10% duty cycle)                               | .....±200mA               |
| (pulsed at 1ms, 50% duty cycle)                               | ..... ±300mA              |

Continuous Power Dissipation (T<sub>A</sub> = +70°C)

|   |                 |
|---|-----------------|
| 36-Bump UCSP (derate 15.3mW/°C above +70°C).... | 1221mW          |
| 36-Pin TQFN (derate 26.3mW/°C above +70°C)..... | 2105mW          |
| Operating Temperature Range .....               | -40°C to +85°C  |
| Junction Temperature.....                       | +150°C          |
| Storage Temperature Range .....                 | -65°C to +150°C |
| Lead Temperature (soldering, 10s) .....         | +300°C          |
| Bump Temperature (soldering)                    |                 |
| Infrared (15s) .....                            | +220°C          |
| Vapor Phase (60s) .....                         | +215°C          |

**Note 1:** Signals on NO<sub>-</sub>, NC<sub>-</sub>, COM<sub>-</sub> exceeding V+ or GND are clamped by internal diodes. Limit forward-diode current to maximum current rating.

Stresses beyond those listed under "Absolute Maximum Ratings" may cause permanent damage to the device. These are stress ratings only, and functional operation of the device at these or any other conditions beyond those indicated in the operational sections of the specifications is not implied. Exposure to absolute maximum rating conditions for extended periods may affect device reliability.

## ELECTRICAL CHARACTERISTICS

(V+ = +2.7V to +5.25V, T<sub>A</sub> = -40°C to +85°C, unless otherwise noted. Typical values are at V+ = 3V, T<sub>A</sub> = +25°C.) (Notes 2, 3)

| PARAMETER  | SYMBOL   | CONDITIONS  | T <sub>A</sub>                       | MIN | TYP | MAX  | UNITS |
|--|--|---|--------------------------------------|-----|-----|------|-------|
| <b>ANALOG SWITCH</b>                                     |  |   |                                      |     |     |      |       |
| Analog Signal Range                                      | V <sub>COM-</sub> ,<br>V <sub>NO-</sub> , V <sub>NC-</sub> |   | T <sub>MIN</sub> to T <sub>MAX</sub> | 0   |     | V+   | V     |
| On-Resistance  | R <sub>ON</sub>  | V+ = 2.7V, I <sub>COM-</sub> = 10mA,<br>V <sub>NC-</sub> or V <sub>NO-</sub> = 0V or V+ (Note 4)                      | +25°C                                | 2.0 | 3.5 |      | Ω     |
|  |  |   | T <sub>MIN</sub> to T <sub>MAX</sub> |     |     | 4    |       |
| On-Resistance Match<br>Between Channels                  | ΔR <sub>ON</sub>   | V+ = 2.7V, I <sub>COM-</sub> = 10mA,<br>V <sub>NO-</sub> or V <sub>NC-</sub> = 1.5V (Notes 4, 5)                      | +25°C                                | 0.2 | 0.4 |      | Ω     |
|  |  |   | T <sub>MIN</sub> to T <sub>MAX</sub> |     |     | 0.55 |       |
| On-Resistance Flatness                                   | R <sub>FLAT(ON)</sub>                                      | V+ = 2.7V, I <sub>COM-</sub> = 10mA,<br>V <sub>NC-</sub> or V <sub>NO-</sub> = 0V or V+ (Note 6)                      | +25°C                                | 0.8 | 1.5 |      | Ω     |
|  |  |   | T <sub>MIN</sub> to T <sub>MAX</sub> |     |     | 1.8  |       |
| NO <sub>-</sub> , NC <sub>-</sub> Off-Leakage<br>Current | I <sub>NO-(OFF)</sub> ,<br>I <sub>NC-(OFF)</sub>           | V+ = 3.6V;<br>V <sub>COM-</sub> = 3.3V, 0.3V;<br>V <sub>NO-</sub> or V <sub>NC-</sub> = 0.3V, 3.3V                    | +25°C                                | -5  |     | +5   | nA    |
|  |  |   | T <sub>MIN</sub> to T <sub>MAX</sub> |     |     | +25  |       |
| COM <sub>-</sub> Off-Leakage Current                     |  | V+ = 3.6V (MAX4761/MAX4761A);<br>V <sub>COM-</sub> = 3.3V, 0.3V; V <sub>NO-</sub> or<br>V <sub>NC-</sub> = 0.3V, 3.3V | +25°C                                | -5  | 0.1 | +5   | nA    |
|  |  |   | T <sub>MIN</sub> to T <sub>MAX</sub> |     |     | +25  |       |
| COM <sub>-</sub> On-Leakage Current                      | I <sub>COM-(ON)</sub>                                      | V+ = 3.6V; V <sub>COM-</sub> = 3.3V, 0.3V; V <sub>NO-</sub><br>or V <sub>NC-</sub> = 3.3V, 0.3V or unconnected        | +25°C                                | -5  |     | +5   | nA    |
|  |  |   | T <sub>MIN</sub> to T <sub>MAX</sub> |     |     | +25  |       |
| <b>DYNAMIC</b>   |  |   |                                      |     |     |      |       |
| Turn-On Time   | t <sub>ON</sub>  | V <sub>NO-</sub> or V <sub>NC-</sub> = 1.5V;<br>R <sub>L</sub> = 50Ω; C <sub>L</sub> = 35pF,<br>Figure 2              | +25°C                                | 45  | 140 |      | ns    |
|  |  |   | T <sub>MIN</sub> to T <sub>MAX</sub> |     |     | 150  |       |
|  |  |   | +25°C                                | 400 | 800 |      | ns    |
|  |  |   | T <sub>MIN</sub> to T <sub>MAX</sub> |     |     | 800  |       |

# High-Bandwidth, Quad DPDT Switches

## ELECTRICAL CHARACTERISTICS (continued)

(V+ = +2.7V to +5.25V, T<sub>A</sub> = -40°C to +85°C, unless otherwise noted. Typical values are at V+ = 3V, T<sub>A</sub> = +25°C.) (Notes 2, 3)

| PARAMETER                    | SYMBOL   | CONDITIONS   | T <sub>A</sub>                       | MIN                                  | TYP  | MAX | UNITS |
|------------------------------|--|--|--------------------------------------|--------------------------------------|------|-----|-------|
| Turn-Off Time                | t <sub>OFF</sub>                                 | V+ = 2.7V, V <sub>NO_</sub> or V <sub>NC_</sub> = 1.5V; R <sub>L</sub> = 50Ω; C <sub>L</sub> = 35pF, Figure 2          | MAX4760/<br>MAX4761                  | +25°C                                | 25   | 50  | ns    |
|                              |  |  |                                      | T <sub>MIN</sub> to T <sub>MAX</sub> |      | 60  |       |
|                              |  | MAX4760A/<br>MAX4761A  | +25°C                                | 300                                  | 800  | ns  |       |
|                              |  |  | T <sub>MIN</sub> to T <sub>MAX</sub> |                                      | 800  |     |       |
| Break-Before-Make            | t <sub>BBM</sub>                                 | V+ = 2.7V, V <sub>NO_</sub> or V <sub>NC_</sub> = 1.5V; R <sub>L</sub> = 50Ω, C <sub>L</sub> = 35pF, Figure 3 (Note 7) | +25°C                                |                                      | 100  | ns  |       |
|                              |  |  | T <sub>MIN</sub> to T <sub>MAX</sub> | 2                                    |      |     |       |
| Skew                         | t <sub>SKEW</sub>                                | R <sub>S</sub> = 39Ω, C <sub>L</sub> = 50pF, Figure 4 (Note 7)   | +25°C                                |                                      | 0.2  | ns  |       |
| Charge Injection             | Q  | V <sub>GEN</sub> = 0V, R <sub>GEN</sub> = 0V, C <sub>L</sub> = 1.0nF, Figure 5   | +25°C                                |                                      | 15   | pC  |       |
| On-Channel -3dB Bandwidth    | BW   | Signal = 0dBm, C <sub>L</sub> = 5pF, R <sub>L</sub> = 50Ω  | +25°C                                |                                      | 150  | MHz |       |
| Off-Isolation                | V <sub>ISO</sub>                                 | C <sub>L</sub> = 5pF, R <sub>L</sub> = 50Ω, V <sub>COM_</sub> = 1VP-P, f = 100kHz, Figure 6 (Note 8)                   | +25°C                                |                                      | 80   | dB  |       |
| Crosstalk                    | V <sub>CT</sub>                                  | C <sub>L</sub> = 5pF, R <sub>L</sub> = 50Ω, V <sub>COM_</sub> = 1VP-P, f = 100kHz, Figure 6 (Note 9)                   | +25°C                                |                                      | 95   | dB  |       |
| Total Harmonic Distortion    | THD  | f = 20Hz to 20kHz, V <sub>COM_</sub> = 1VP-P, DC bias = V+/2, R <sub>L</sub> = R <sub>S</sub> = 600Ω                   | +25°C                                |                                      | 0.03 | %   |       |
| NO_, NC_ Off-Capacitance     | C <sub>NO_(OFF)</sub> ,<br>C <sub>NC_(OFF)</sub> | V <sub>NO_</sub> , V <sub>NC_</sub> = GND, f = 1MHz, Figure 7  | +25°C                                |                                      | 25   | pF  |       |
| COM_ On-Capacitance          | C <sub>COM(ON)</sub>                             | V <sub>NO_</sub> , V <sub>NC_</sub> = GND, f = 1MHz, Figure 7  | +25°C                                |                                      | 54   | pF  |       |
| COM_ Off-Capacitance         | C <sub>COM(OFF)</sub>                            | V <sub>COM_</sub> = GND, f = 1MHz (MAX4761/<br>MAX4761A), Figure 7   | +25°C                                |                                      | 25   | pF  |       |
| <b>DIGITAL I/O (IN_, EN)</b> |  |  |                                      |                                      |      |     |       |
| Input-Logic High             | V <sub>IH</sub>                                  | V+ = 2.7V to 3.6V  | T <sub>MIN</sub> to T <sub>MAX</sub> | 1.4                                  | V    |     |       |
|                              |  | V+ = 3.6V to 5.5V<br>(MAX4760A/MAX4761A)   | T <sub>MIN</sub> to T <sub>MAX</sub> | 1.6                                  |      |     |       |
|                              |  | V+ = 3.6V to 5.25V<br>(MAX4760/MAX4761)  | T <sub>MIN</sub> to T <sub>MAX</sub> | 2.0                                  |      |     |       |
| Input-Logic Low              | V <sub>IL</sub>                                  | V+ = 2.7V to 3.6V  | T <sub>MIN</sub> to T <sub>MAX</sub> | 0.5                                  | V    |     |       |
|                              |  | V+ = 3.6V to 5.5V<br>(MAX4760A/MAX4761A)   | T <sub>MIN</sub> to T <sub>MAX</sub> | 0.5                                  |      |     |       |
|                              |  | V+ = 3.6V to 5.25V<br>(MAX4760/MAX4761)  | T <sub>MIN</sub> to T <sub>MAX</sub> | 0.6                                  |      |     |       |
| Input Leakage Current        | I <sub>IN</sub> , I <sub>EN</sub>                | V <sub>IN</sub> = 0V or V+   | T <sub>MIN</sub> to T <sub>MAX</sub> |                                      | 1    | μA  |       |

MAX4760/MAX4760A/MAX4761/MAX4761A

# High-Bandwidth, Quad DPDT Switches

## ELECTRICAL CHARACTERISTICS (continued)

( $V_+ = +2.7V$  to  $+5.25V$ ,  $T_A = -40^\circ C$  to  $+85^\circ C$ , unless otherwise noted. Typical values are at  $V_+ = 3V$ ,  $T_A = +25^\circ C$ .) (Notes 2, 3)

| PARAMETER   | SYMBOL                 | CONDITIONS   | $T_A$                  | MIN | TYP  | MAX | UNITS   |
|---|------------------------|--|------------------------|-----|------|-----|---------|
| <b>POWER SUPPLY</b>                                     |                        |  |                        |     |      |     |         |
| Power-Supply Range                                      | $V_+$                  |  | $T_{MIN}$ to $T_{MAX}$ | 1.8 |      | 5.5 | V       |
| Power Supply Current                                    | $I_+$                  | $V_+ = 4.3V$ , $V_{IN\_} = 0V$ or $V_+$<br>(MAX4760/MAX4761)   | $+25^\circ C$          |     | 0.01 |     | $\mu A$ |
|   |                        |  | $T_{MIN}$ to $T_{MAX}$ |     |      | 1.0 |         |
|   |                        | $V_+ = 5.5V$ , $V_{IN\_} = 0V$ or $V_+$<br>(MAX4760A/MAX4761A) | $+25^\circ C$          |     | 0.01 |     |         |
|   |                        |  | $T_{MIN}$ to $T_{MAX}$ |     |      | 1.0 |         |
| $V_+ = 5.5V$ , $V_{IN\_} = 1.8V$<br>(MAX4760A/MAX4761A) | $+25^\circ C$          |  |                        | 5.5 |      |     |         |
|   | $T_{MIN}$ to $T_{MAX}$ |  |                        |     | 12   |     |         |

**Note 2:** The algebraic convention is used in this data sheet; the most negative value is shown in the minimum column.

**Note 3:** UCSP packages are 100% tested at  $+25^\circ C$  and limits across the full temperature range are guaranteed by correlation and design. TQFN packages are 100% tested at  $+85^\circ C$  and limits across the full temperature range are guaranteed by correlation and design.

**Note 4:**  $R_{ON}$  and  $\Delta R_{ON}$  matching specifications are guaranteed by design.

**Note 5:**  $\Delta R_{ON} = R_{ON}(MAX) - R_{ON}(MIN)$ .

**Note 6:** Flatness is defined as the difference between the maximum and minimum value of on-resistance as measured over the specified analog signal ranges.

**Note 7:** Guaranteed by design, not production tested.

**Note 8:** Off-isolation =  $20 \log_{10} [V_{COM\_} / (V_{NO\_} \text{ or } V_{NC\_})]$ ,  $V_{COM\_}$  = output,  $V_{NO\_}$  or  $V_{NC\_}$  = input to off switch.

**Note 9:** Between any two switches.

## Typical Operating Characteristics

( $V_+ = 3V$ ,  $T_A = +25^\circ C$ , unless otherwise noted.)

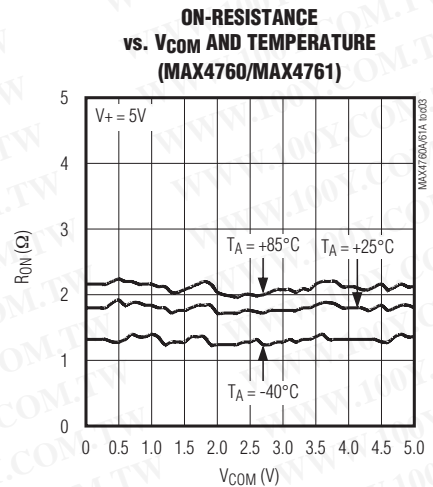
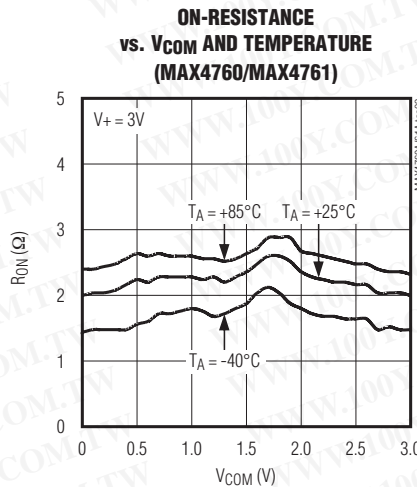
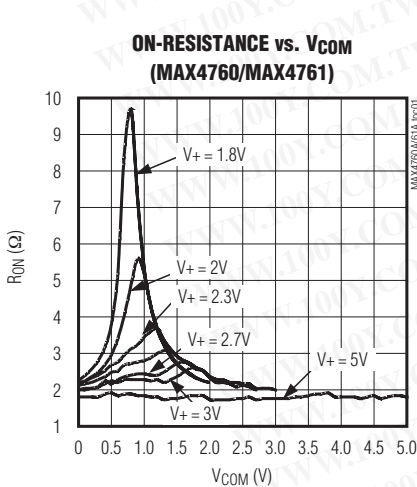

# High-Bandwidth, Quad DPDT Switches

## Typical Operating Characteristics (continued)

( $V_+ = 3V$ ,  $T_A = +25^\circ C$ , unless otherwise noted.)

**ON-RESISTANCE vs.  $V_{COM}$**   
(MAX4760A/MAX4761A)

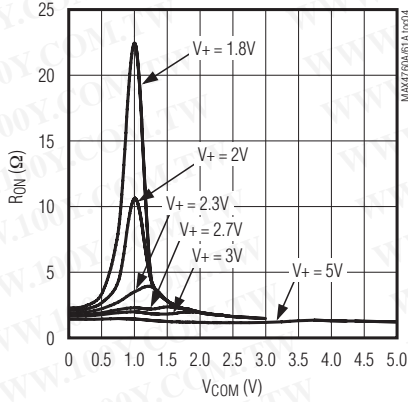

**ON-RESISTANCE vs.  $V_{COM}$  AND TEMPERATURE**  
(MAX4760A/MAX4761A)

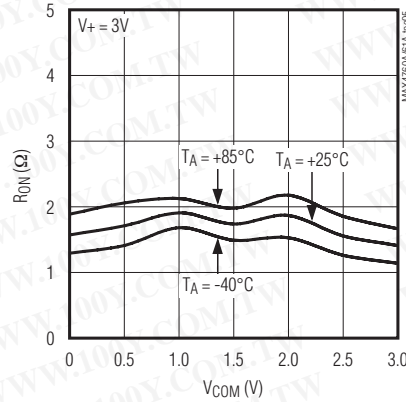

**ON-RESISTANCE vs.  $V_{COM}$  AND TEMPERATURE**  
(MAX4760A/MAX4761A)

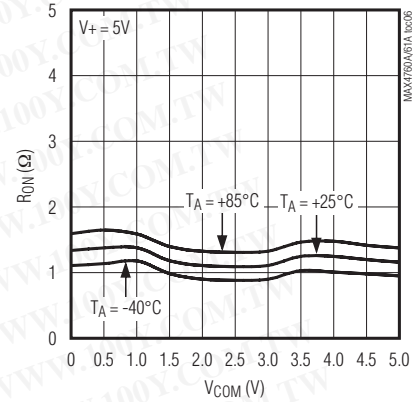

**NO/NC OFF-LEAKAGE CURRENT vs. TEMPERATURE**

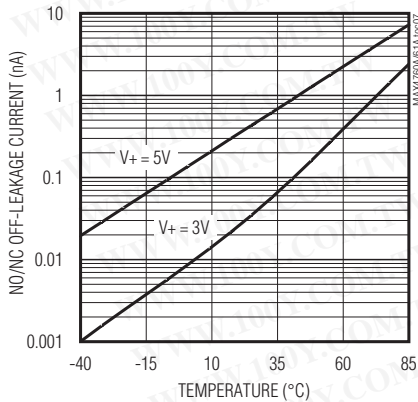

**COM ON-LEAKAGE CURRENT vs. TEMPERATURE**

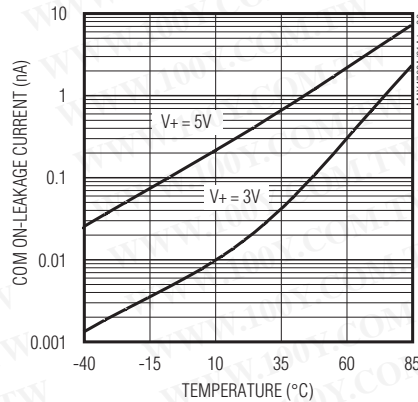

**COM OFF-LEAKAGE CURRENT vs. TEMPERATURE**

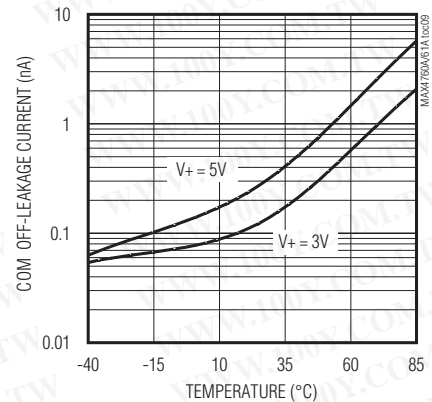

**CHARGE INJECTION vs.  $V_{COM}$**

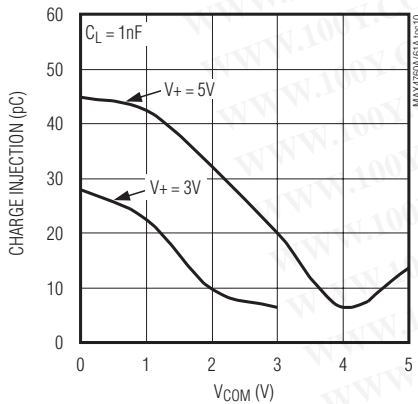

**SUPPLY CURRENT vs. SUPPLY VOLTAGE**

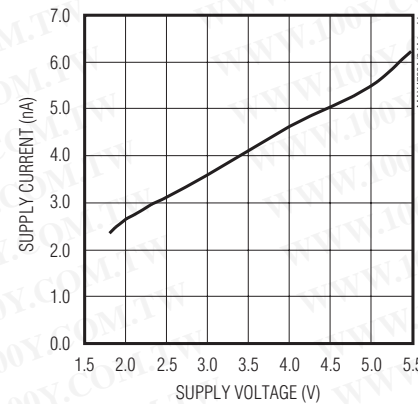

**SUPPLY CURRENT vs. TEMPERATURE**

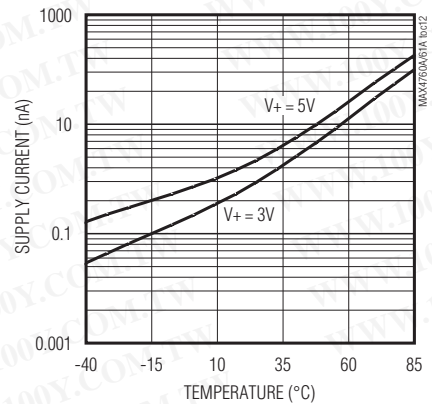

MAX4760/MAX4760A/MAX4761/MAX4761A

# High-Bandwidth, Quad DPDT Switches

## Typical Operating Characteristics (continued)

( $V_+ = 3V$ ,  $T_A = +25^\circ C$ , unless otherwise noted.)

**LOGIC THRESHOLD vs. SUPPLY VOLTAGE**

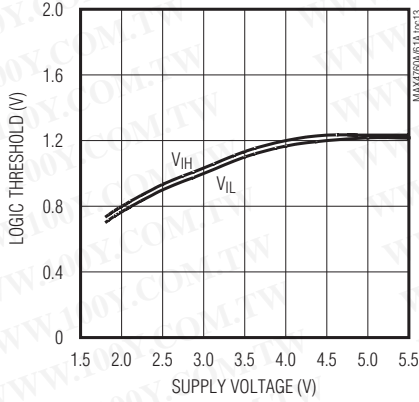

**TURN-ON/OFF TIME vs. SUPPLY VOLTAGE (MAX4760/MAX4761)**

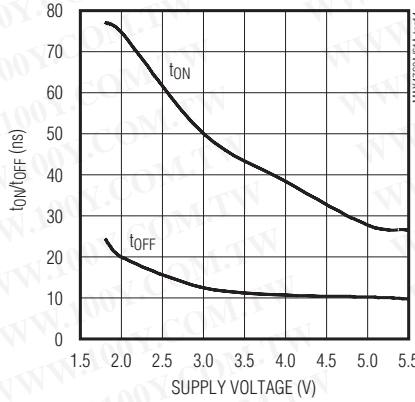

**TURN-ON/OFF TIME vs. SUPPLY VOLTAGE (MAX4760A/MAX4761A)**

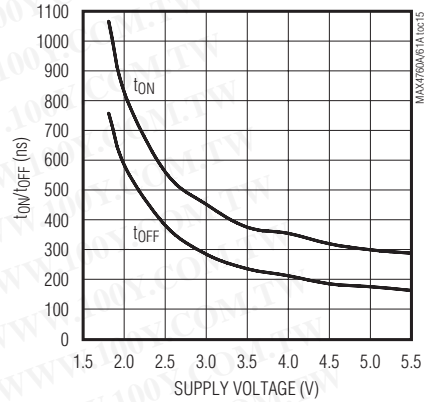

**TURN-ON/OFF TIMES vs. TEMPERATURE (MAX4760/MAX4761)**

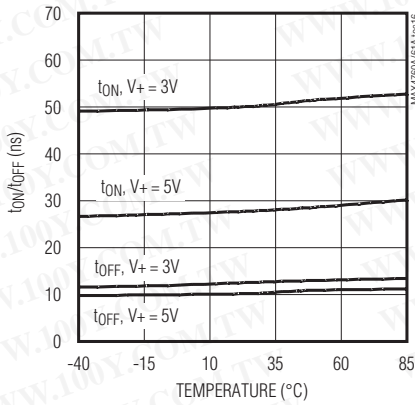

**TURN-ON/OFF TIMES vs. TEMPERATURE (MAX4760A/MAX4761A)**

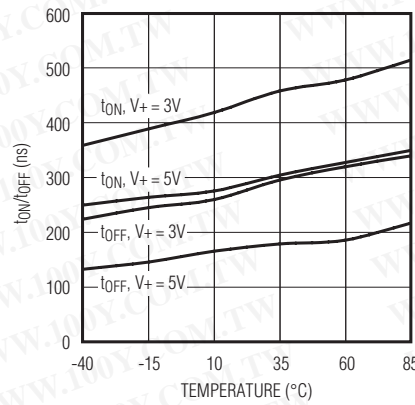

**FREQUENCY RESPONSE**

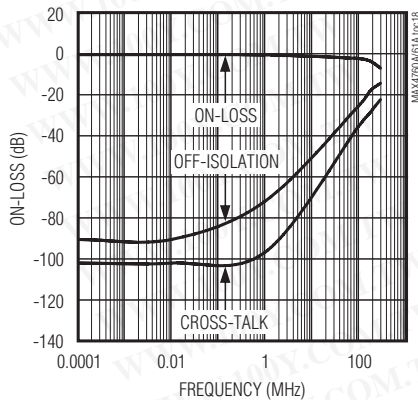

**TOTAL HARMONIC DISTORTION vs. FREQUENCY**

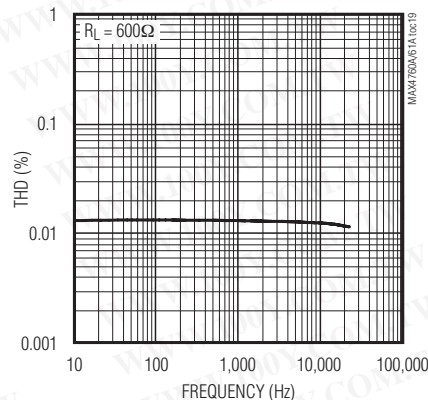

# High-Bandwidth, Quad DPDT Switches

## Pin Description

| PIN                          |        |                                     |        | NAME | FUNCTION   |
|------------------------------|--------|-------------------------------------|--------|------|--|
| MAX4760/MAX4760A             |        | MAX4761/MAX4761A                    |        |      |  |
| TQFN-EP                      | UCSP   | TQFN-EP                             | UCSP   |      |  |
| 1                            | A1     | 1                                   | A1     | NC1  | Analog Switch 1, Normally Closed Terminal 1  |
| 2                            | B2     | 2                                   | B2     | COM2 | Analog Switch 2, Common Terminal 2   |
| 3                            | A2     | 3                                   | A2     | NC2  | Analog Switch 2, Normally Closed Terminal 2  |
| 4                            | A3     | 4                                   | A3     | INA  | Logic Control Digital Input for the MAX4760/MAX4760A Switch 1 and Switch 2. Digital control input for all MAX4761/MAX4761A switches. |
| 5                            | C3, D4 | 5                                   | C3, D4 | V+   | Positive Supply Voltage  |
| 6                            | A4     | —                                   | —      | INB  | Logic Control Digital Input for Switches 3 and 4   |
| 7                            | A5     | 7                                   | A5     | NC3  | Analog Switch 3, Normally Closed Terminal 3  |
| 8                            | B5     | 8                                   | B5     | COM3 | Analog Switch 3, Common Terminal 3   |
| 9                            | A6     | 9                                   | A6     | NC4  | Analog Switch 4, Normally Closed Terminal 4  |
| 10                           | B6     | 10                                  | B6     | COM4 | Analog Switch 4, Common Terminal 4   |
| 11, 14,<br>17, 29,<br>32, 35 | —      | 6, 11, 14,<br>17, 24,<br>29, 32, 35 | A4, F3 | N.C. | No Connection. Leave N.C. unconnected.   |
| 12                           | C5     | 12                                  | C5     | NO3  | Analog Switch 3, Normally Open Terminal 3  |
| 13                           | C6     | 13                                  | C6     | NO4  | Analog Switch 4, Normally Open Terminal 4  |
| 15                           | D6     | 15                                  | D6     | NO8  | Analog Switch 8, Normally Open Terminal 8  |
| 16                           | D5     | 16                                  | D5     | NO7  | Analog Switch 7, Normally Open Terminal 7  |
| 18                           | E6     | 18                                  | E6     | COM8 | Analog Switch 8, Common Terminal 8   |
| 19                           | F6     | 19                                  | F6     | NC8  | Analog Switch 8, Normally Closed Terminal 8  |
| 20                           | E5     | 20                                  | E5     | COM7 | Analog Switch 7, Common Terminal 7   |
| 21                           | F5     | 21                                  | F5     | NC7  | Analog Switch 7, Normally Closed Terminal 7  |
| 22                           | F4     | —                                   | —      | IND  | Logic Control Digital Input for Switches 7 and 8   |
| 23                           | C4, D3 | 23                                  | C4, D3 | GND  | Ground   |
| 24                           | F3     | —                                   | —      | INC  | Logic Control Digital Input for Switches 5 and 6   |
| 25                           | F2     | 25                                  | F2     | NC6  | Analog Switch 6, Normally Closed Terminal 6  |
| 26                           | E2     | 26                                  | E2     | COM6 | Analog Switch 6, Common Terminal 6   |
| 27                           | F1     | 27                                  | F1     | NC5  | Analog Switch 5, Normally Closed Terminal 5  |
| 28                           | E1     | 28                                  | E1     | COM5 | Analog Switch 5, Common Terminal 5   |
| 30                           | D2     | 30                                  | D2     | NO6  | Analog Switch 6, Normally Open Terminal 6  |
| 31                           | D1     | 31                                  | D1     | NO5  | Analog Switch 5, Normally Open Terminal 5  |
| 33                           | C1     | 33                                  | C1     | NO1  | Analog Switch 1, Normally Open Terminal 1  |
| 34                           | C2     | 34                                  | C2     | NO2  | Analog Switch 2, Normally Open Terminal 2  |
| 36                           | B1     | 36                                  | B1     | COM1 | Analog Switch 1, Common Terminal 1   |
| —                            | —      | 22                                  | F4     | EN   | Output Enable, Active Low  |
| —                            | —      | —                                   | —      | EP   | Exposed Pad (TQFN Only). Connect EP to GND.  |

MAX4760/MAX4760A/MAX4761/MAX4761A

# High-Bandwidth, Quad DPDT Switches

## Detailed Description

The MAX4760/MAX4760A quad double-pole/double-throw (DPDT) and the MAX4761/MAX4761A octal single-pole/double-throw (SPDT) analog switches operate from a single +1.8V to +5.5V supply. These devices are fully specified for +3V applications.

The MAX4760/MAX4760A/MAX4761/MAX4761A have a guaranteed  $2.0\Omega$  (typ) on-resistance to switch data or audio signals. The low 54pF (typ) capacitance and 0.2ns change in skew makes them ideal for data switching applications. The MAX4760/MAX4760A have four logic inputs to control two switches in pairs and the MAX4761/MAX4761A have one logic control input and an enable input ( $\overline{EN}$ ) to disable the switches.

## Applications Information

### Digital Control Inputs

The MAX4760/MAX4760A/MAX4761/MAX4761A logic inputs accept up to +5.5V regardless of the supply voltage. For example, with a +3.3V supply,  $IN_{-}$  can be driven low to GND and high to +5.5V, which allows mixed logic levels in a system. Driving the control logic inputs rail-to-rail also minimizes power consumption.

For the MAX4761/MAX4761A, drive  $\overline{EN}$  low to enable. When  $\overline{EN}$  is high,  $COM_{-}$  is high impedance.

### Analog Signal Levels

Analog signal inputs over the full voltage range (0V to  $V_{+}$ ) are passed through the switch with minimal change in on-resistance (see the *Typical Operating Characteristics*). The switches are bidirectional so  $NO_{-}$ ,  $NC_{-}$ , and  $COM_{-}$  can be either inputs or outputs.

### Power-Supply Bypassing

Power-supply bypassing improves noise margin and prevents switching noise from propagating from the  $V_{+}$  supply to other components. A 0.1 $\mu$ F capacitor connected from  $V_{+}$  to GND is adequate for most applications.

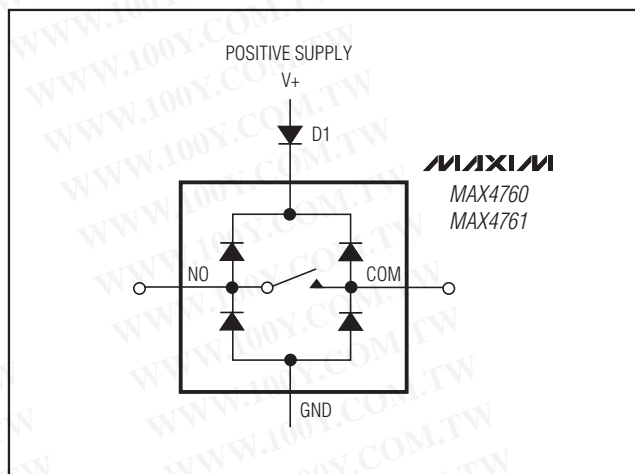

Figure 1. Overvoltage Protection Using an External Blocking Diode

### Power-Supply Sequencing

CMOS devices require proper power-supply sequencing. Always apply  $V_{+}$  before the analog signals, especially if the input signal is not current limited. If sequencing is not possible, and the input signal is not current limited to less than 20mA, add a small-signal diode (Figure 1). Adding the diode reduces the analog range to a diode drop (0.7V) below  $V_{+}$  and increases the on-resistance slightly. The maximum supply voltage must not exceed +6V at any time.

## UCSP Applications Information

For the latest application details on UCSP construction, dimensions, tape carrier information, printed circuit board techniques, bump-pad layout, and recommended reflow temperature profile, as well as the latest information on reliability testing results, refer to the Application Note 1891: *Wafer-Level Packaging (WLP) and Its Applications* available on Maxim's website at [www.maxim-ic.com/ucsp](http://www.maxim-ic.com/ucsp).

# High-Bandwidth, Quad DPDT Switches

## Timing Circuits/Timing Diagrams

MAX4760/MAX4760A/MAX4761/MAX4761A

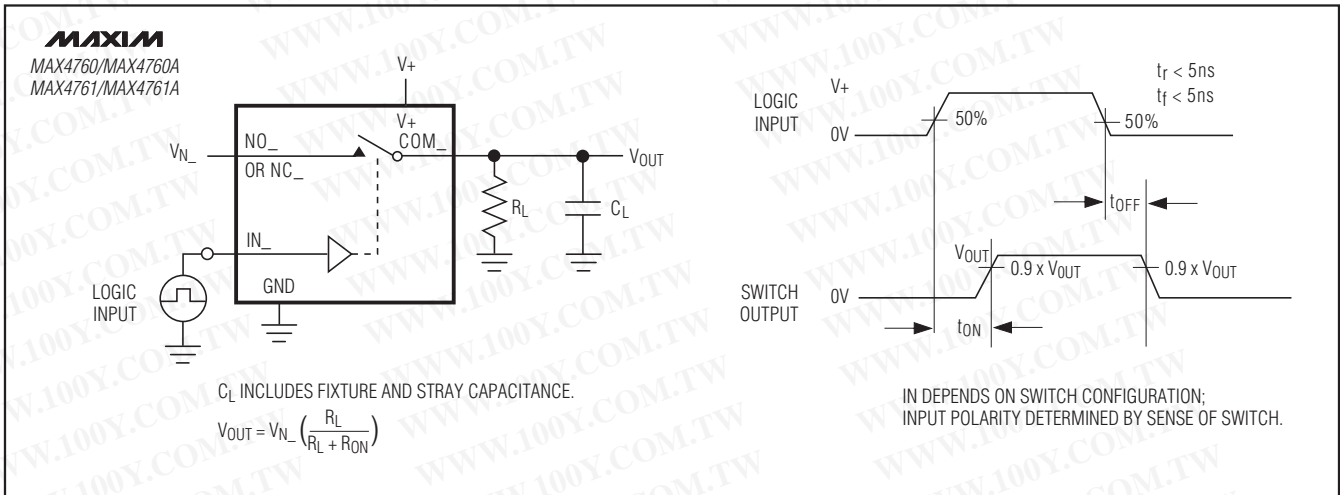

Figure 2. Switching Time

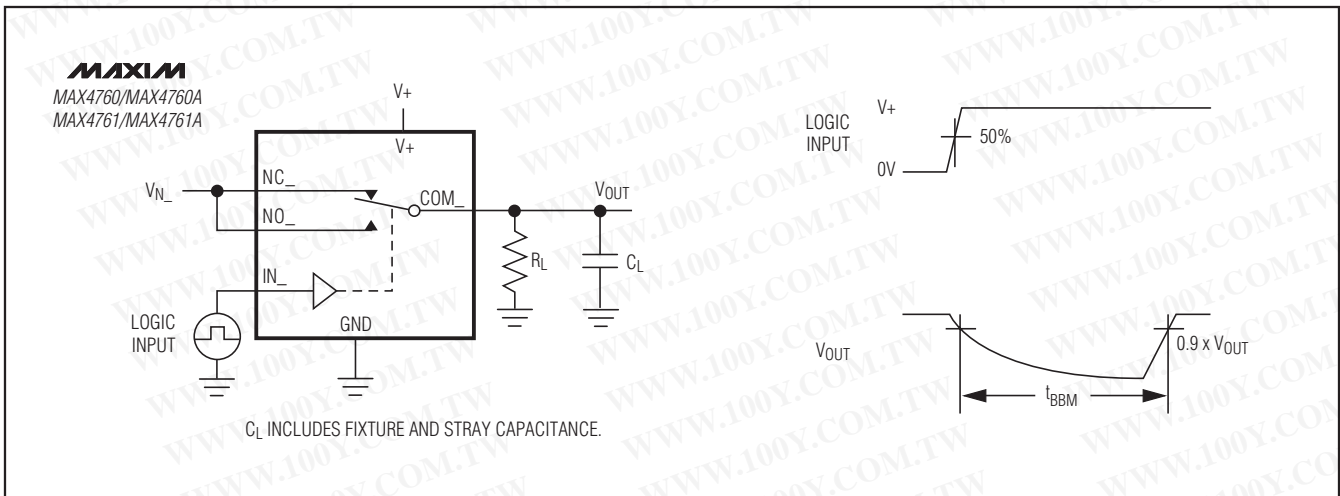

Figure 3. Break-Before-Make Interval

# High-Bandwidth, Quad DPDT Switches

## Timing Circuits/Timing Diagrams (continued)

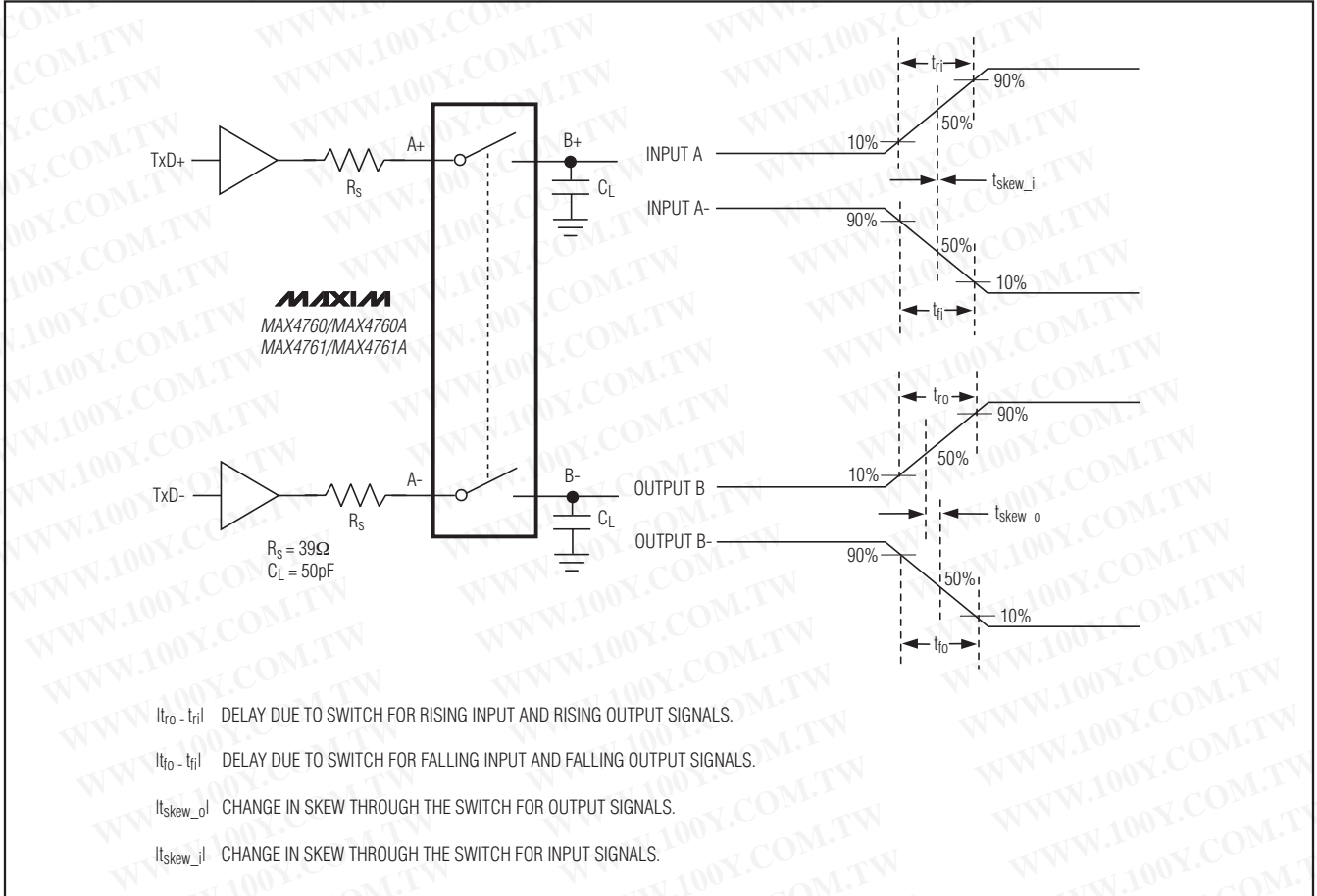

Figure 4. Input/Output Skew Timing Diagram

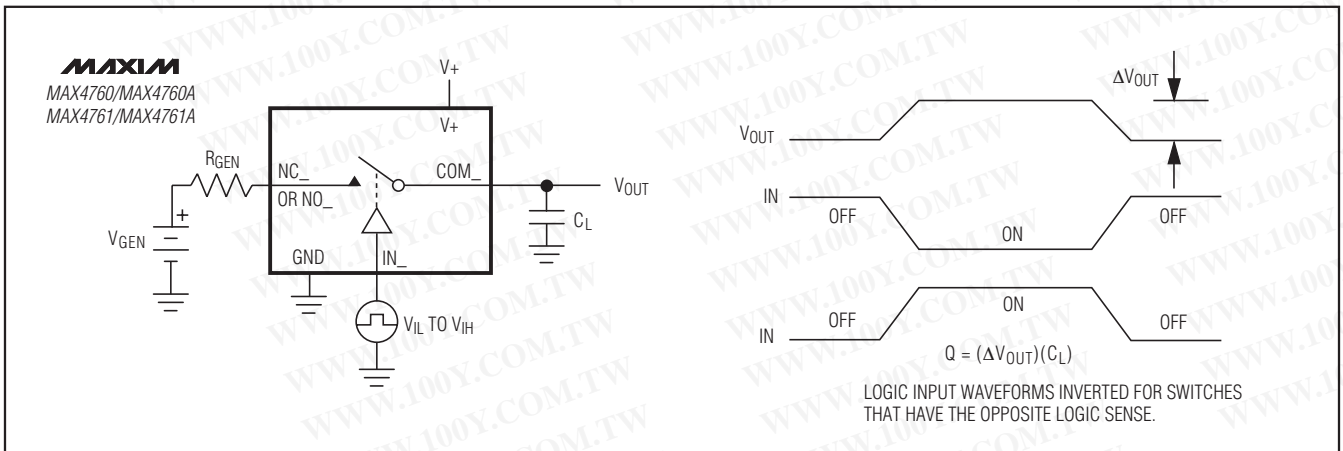

Figure 5. Charge Injection

# High-Bandwidth, Quad DPDT Switches

## Timing Circuits/Timing Diagrams (continued)

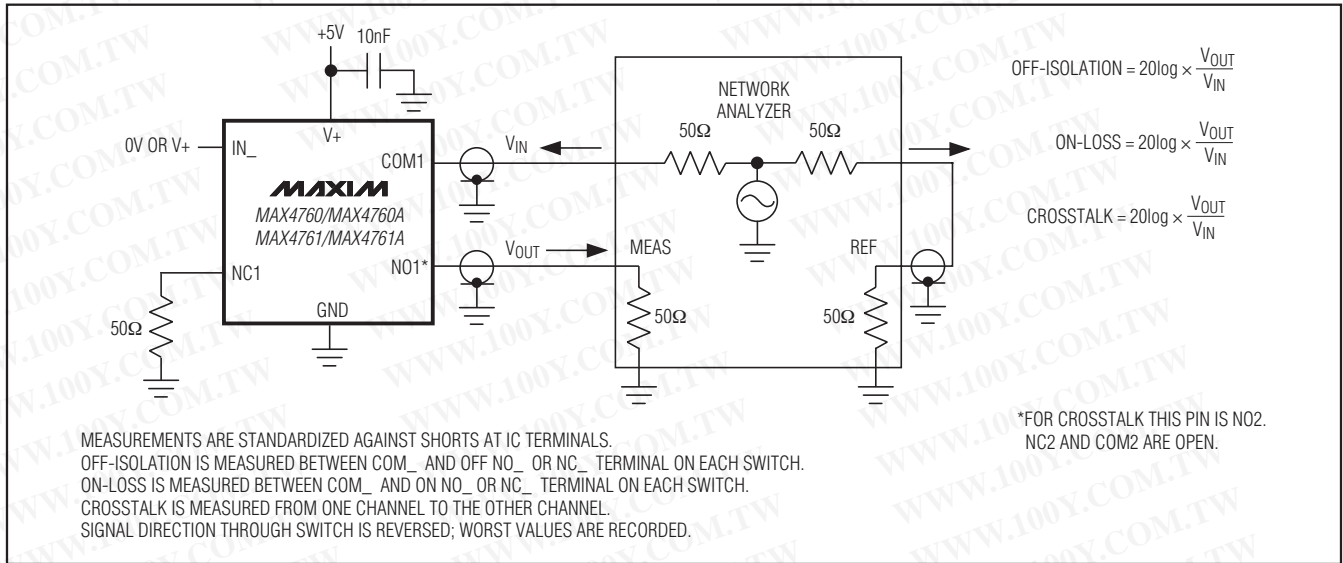
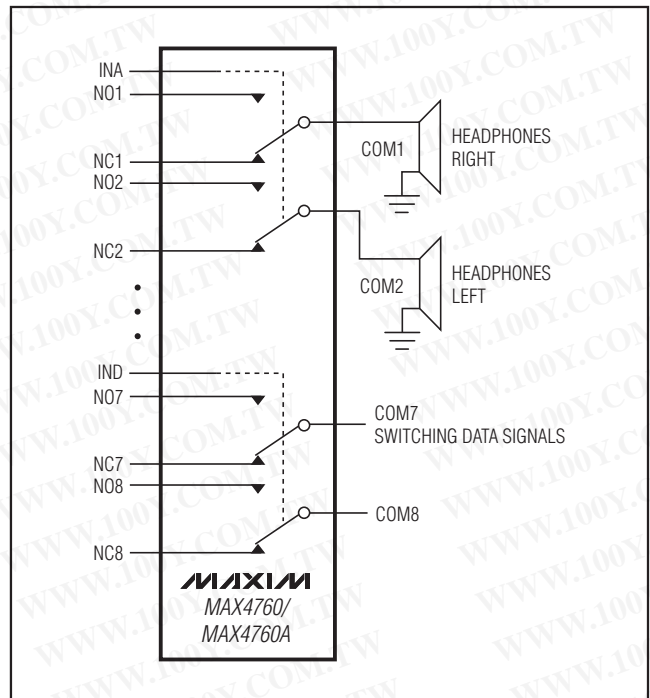
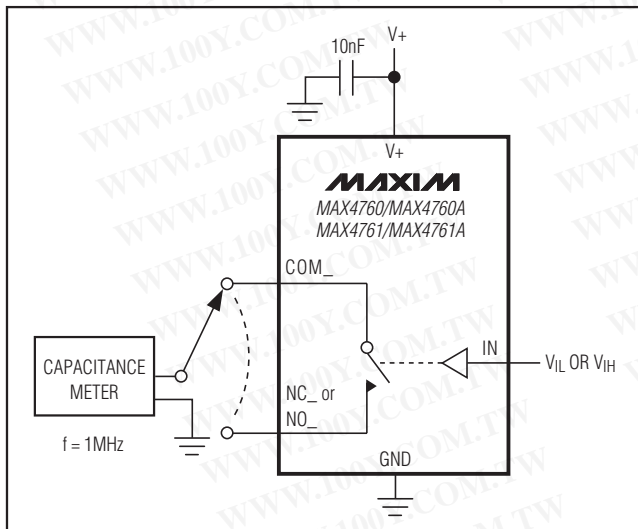

Figure 6. On-Loss, Off-Isolation, and Crosstalk

## Typical Operating Circuit



MAX4760/MAX4760A/MAX4761/MAX4761A

# High-Bandwidth, Quad DPDT Switches

## Pin Configurations/Truth Tables

TOP VIEW

**MAXIM**  
MAX4760/MAX4760A

(BUMP SIDE DOWN)

**UCSP**

**TQFN**

\*EXPOSED PADDLE CONNECTED TO GND.

| INA  | NO1/NO2 | NC1/NC2 |
|------|---------|---------|
| LOW  | OFF     | ON      |
| HIGH | ON      | OFF     |
| INB  | NO3/NO4 | NC3/NC4 |
| LOW  | OFF     | ON      |
| HIGH | ON      | OFF     |
| INC  | NO5/NO6 | NC5/NC6 |
| LOW  | OFF     | ON      |
| HIGH | ON      | OFF     |
| IND  | NO7/NO8 | NC7/NC8 |
| LOW  | OFF     | ON      |
| HIGH | ON      | OFF     |

# High-Bandwidth, Quad DPDT Switches

## Pin Configurations/Truth Tables (continued)

MAX4760/MAX4760A/MAX4761/MAX4761A

TOP VIEW

**MAXIM**  
MAX4761/MAX4761A

(BUMP SIDE DOWN)

**UCSP**

|   | 1    | 2    | 3    | 4    | 5    | 6    |
|---|------|------|------|------|------|------|
| A | NC1  | NC2  | INA  | N.C. | NC3  | NC4  |
| B | COM1 | COM2 |      |      | COM3 | COM4 |
| C | NO1  | NO2  | V+   | GND  | NO3  | NO4  |
| D | NO5  | NO6  | GND  | V+   | NO7  | NO8  |
| E | COM5 | COM6 |      |      | COM7 | COM8 |
| F | NC5  | NC6  | N.C. | EN   | NC7  | NC8  |

**TQFN**

|  | 36   | 35   | 34  | 33  | 32   | 31  | 30  | 29   | 28   |  | 27  | 26   | 25  | 24   | 23  | 22 | 21  | 20   | 19  |  | 18   | 17   | 16  | 15  | 14   | 13  | 12  | 11   | 10   |
|--|------|------|-----|-----|------|-----|-----|------|------|--|-----|------|-----|------|-----|----|-----|------|-----|--|------|------|-----|-----|------|-----|-----|------|------|
|  | COM1 | N.C. | NO2 | NO1 | N.C. | NO5 | NO6 | N.C. | COM5 |  | NC5 | COM6 | NC6 | N.C. | GND | EN | NC7 | COM7 | NC8 |  | COM8 | N.C. | NO8 | NO7 | N.C. | NO4 | NO3 | N.C. | COM4 |

\*EXPOSED PADDLE CONNECTED TO GND.

**MAX4761/MAX4761A**

| EN   | INA  | NO <sub>-</sub> | NC <sub>-</sub> |
|------|------|-----------------|-----------------|
| LOW  | LOW  | OFF             | ON              |
| LOW  | HIGH | ON              | OFF             |
| HIGH | X    | OFF             | OFF             |
| HIGH | X    | OFF             | OFF             |

### Chip Information

PROCESS: CMOS

### Package Information

For the latest package outline information and land patterns, go to [www.maxim-ic.com/packages](http://www.maxim-ic.com/packages).

| PACKAGE TYPE | PACKAGE CODE | DOCUMENT NO.            |
|--------------|--------------|-------------------------|
| 36 UCSP      | B36-2        | <a href="#">21-0082</a> |
| 36 TQFN-EP   | T3666-3      | <a href="#">21-0141</a> |

# High-Bandwidth, Quad DPDT Switches

## Revision History

| REVISION NUMBER | REVISION DATE | DESCRIPTION   | PAGES CHANGED |
|-----------------|---------------|---|---------------|
| 4               | 4/07          | Addition of MAX4760A/MAX4761A   | 1-14          |
| 5               | 4/09          | Revised <i>Ordering Information</i> , <i>Electrical Characteristics</i> table, and <i>Pin Description</i> . | 1, 3, 7       |

MAX4760/MAX4760A/MAX4761/MAX4761A

Maxim cannot assume responsibility for use of any circuitry other than circuitry entirely embodied in a Maxim product. No circuit patent licenses are implied. Maxim reserves the right to change the circuitry and specifications without notice at any time.

14 **Maxim Integrated Products, 120 San Gabriel Drive, Sunnyvale, CA 94086 408-737-7600**