

# LP3985

**LP3985 Micropower, 150mA Low-Noise Ultra Low-Dropout CMOS Voltage Regulator**



Literature Number: SNVS087AB

勝特力材料 886-3-5753170  
勝特力电子(上海) 86-21-34970699  
勝特力电子(深圳) 86-755-83298787  
[Http://www.100y.com.tw](http://www.100y.com.tw)

## LP3985

# Micropower, 150mA Low-Noise Ultra Low-Dropout CMOS Voltage Regulator

### General Description

The LP3985 is designed for portable and wireless applications with demanding performance and space requirements.

The LP3985 is stable with a small 1  $\mu$ F  $\pm$ 30% ceramic or high-quality tantalum output capacitor. The micro SMD requires the smallest possible PC board area - the total application circuit area can be less than 2.0mm x 2.5mm, a fraction of a 1206 case size.

The LP3985's performance is optimized for battery powered systems to deliver ultra low noise, extremely low dropout voltage and low quiescent current. Regulator ground current increases only slightly in dropout, further prolonging the battery life.

An optional external bypass capacitor reduces the output noise without slowing down the load transient response. Fast startup time is achieved by utilizing an internal power-on circuit that actively pre-charges the bypass capacitor.

Power supply rejection is better than 50dB at low frequencies and starts to roll off at 1kHz. High power supply rejection is maintained down to low input voltage levels common to battery operated circuits.

The device is ideal for mobile phone and similar battery powered wireless applications. It provides up to 150mA, from a 2.5V to 6V input. The LP3985 consumes less than 1.5  $\mu$ A in disable mode and has fast turn-on time less than 200  $\mu$ s.

The LP3985 is available in a 5-bump thin micro SMD and a 5-pin SOT-23 package. Performance is specified for  $-40^{\circ}$ C to  $+125^{\circ}$ C temperature range and is available in 2.5V, 2.6V, 2.7V, 2.8V, 2.85V, 2.9V, 3.0V, 3.1V, 3.2V, 3.3V, 4.7V, 4.75V, 4.8V and 5.0V output voltages. For other output voltage op-

tions between 2.5V to 5.0V or for a dual LP3985, please contact a Texas Instruments sales office.

### Key Specifications

- 2.5 to 6.0V input range
- 150mA guaranteed output
- 50dB PSRR at 1kHz @  $V_{IN} = V_{OUT} + 0.2V$
- $\leq 1.5\mu A$  quiescent current when shut down
- Fast Turn-On time: 200  $\mu$ s (typ.)
- 100mV maximum dropout with 150mA load
- 30  $\mu$ Vrms output noise (typ.) over 10Hz to 100kHz
- $-40$  to  $+125^{\circ}$ C junction temperature range for operation
- 2.5V, 2.6V, 2.7V, 2.8V, 2.85V, 2.9V, 3.0V, 3.1V, 3.2V, 3.3V, 4.7V, 4.75V, 4.8V and 5.0V outputs standard

### Features

- Miniature 5-I/O micro SMD and SOT-23-5 package
- Logic controlled enable
- Stable with ceramic and high quality tantalum capacitors
- Fast turn-on
- Thermal shutdown and short-circuit current limit

### Applications

- CDMA cellular handsets
- Wideband CDMA cellular handsets
- GSM cellular handsets
- Portable information appliances

### Typical Application Circuit

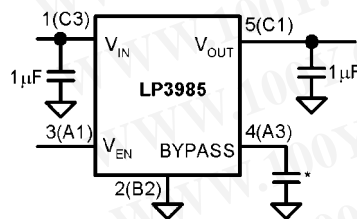

10136402

Note: Pin Numbers in parenthesis indicate micro SMD package.

\* Optional Noise Reduction Capacitor.

勝特力材料 886-3-5753170  
 勝特力电子(上海) 86-21-34970699  
 勝特力电子(深圳) 86-755-83298787  
[Http://www.100y.com.tw](http://www.100y.com.tw)

## Block Diagram

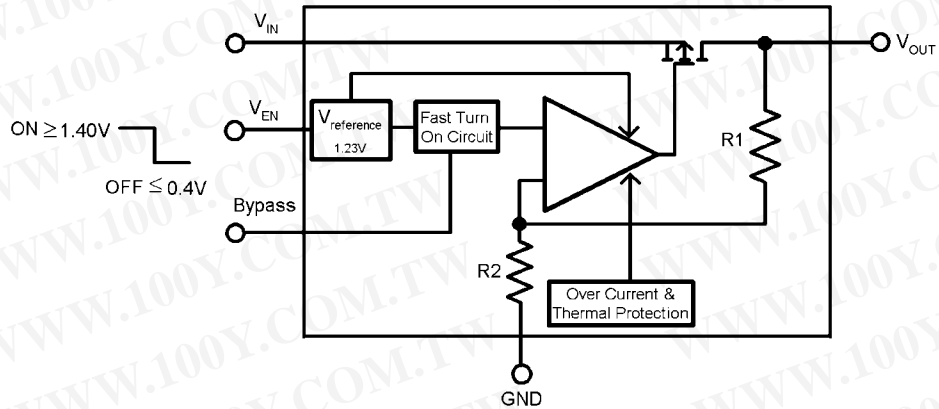

10136401

## Pin Descriptions

Name	* micro SMD	SOT	Function
V <sub>EN</sub>	A1	3	Enable Input Logic, Enable High
GND	B2	2	Common Ground
V <sub>OUT</sub>	C1	5	Output Voltage of the LDO
V <sub>IN</sub>	C3	1	Input Voltage of the LDO
BYPASS	A3	4	Optional Bypass Capacitor for Noise Reduction

\* The pin numbering scheme for the micro SMD package was revised in April 2002 to conform to JEDEC standard. Only the pin numbers were revised. No changes to the physical location of the inputs/outputs were made. For reference purposes, the obsolete numbering scheme had VEN as pin 1, GND as pin 2, VOUT as pin 3, VIN as pin 4, and BYPASS as pin 5.

## Connection Diagrams

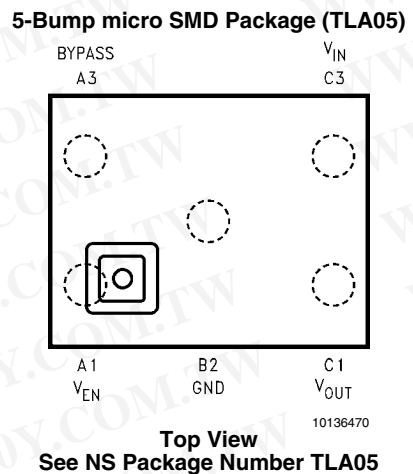
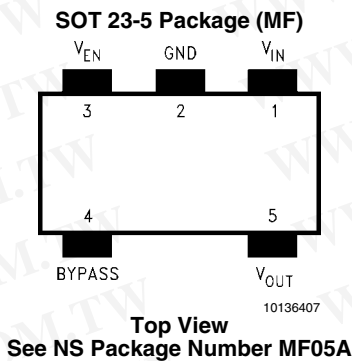

勝特力材料 886-3-5753170  
 勝特力电子(上海) 86-21-34970699  
 勝特力电子(深圳) 86-755-83298787  
[Http://www.100y.com.tw](http://www.100y.com.tw)

## Ordering Information

TL refers to 0.300mm bump size, 0.600mm height for micro SMD Package

Output Voltage (V)	Grade	LP3985 Supplied as 250 Units, Tape and Reel	LP3985 Supplied as 3000 Units, Tape and Reel
2.5	STD	LP3985ITL-2.5	LP3985ITLX-2.5
2.6	STD	LP3985ITL-2.6	LP3985ITLX-2.6
2.7	STD	LP3985ITL-2.7	LP3985ITLX-2.7
2.8	STD	LP3985ITL-2.8	LP3985ITLX-2.8
2.85	STD	LP3985ITL-285	LP3985ITLX-285
2.9	STD	LP3985ITL-2.9	LP3985ITLX-2.9
3.0	STD	LP3985ITL-3.0	LP3985ITLX-3.0
3.1	STD	LP3985ITL-3.1	LP3985ITLX-3.1
3.2	STD	LP3985ITL-3.2	LP3985ITLX-3.2
3.3	STD	LP3985ITL-3.3	LP3985ITLX-3.3
4.75	STD	LP3985ITL-4.75	LP3985ITLX-4.75
4.8	STD	LP3985ITL-4.8	LP3985ITLX-4.8
5.0	STD	LP3985ITL-5.0	LP3985ITLX-5.0

### For SOT Package

Output Voltage (V)	Grade	LP3985 Supplied as 1000 Units, Tape and Reel	LP3985 Supplied as 3000 Units, Tape and Reel	Package Marking
2.5	STD	LP3985IM5-2.5	LP3985IM5X-2.5	LCSB
2.6	STD	LP3985IM5-2.6	LP3985IM5X-2.6	LCTB
2.7	STD	LP3985IM5-2.7	LP3985IM5X-2.7	LCUB
2.8	STD	LP3985IM5-2.8	LP3985IM5X-2.8	LCJB
2.85	STD	LP3985IM5-285	LP3985IM5X-285	LCXB
2.9	STD	LP3985IM5-2.9	LP3985IM5X-2.9	LCYB
3.0	STD	LP3985IM5-3.0	LP3985IM5X-3.0	LCRB
3.1	STD	LP3985IM5-3.1	LP3985IM5X-3.1	LCZB
3.2	STD	LP3985IM5-3.2	LP3985IM5X-3.2	LDPB
3.3	STD	LP3985IM5-3.3	LP3985IM5X-3.3	LDQB
4.7	STD	LP3985IM5-4.7	LP3985IM5X-4.7	LDRB
5.0	STD	LP3985IM5-5.0	LP3985IM5X-5.0	LDSB

勝特力材料 886-3-5753170  
 勝特力电子(上海) 86-21-34970699  
 勝特力电子(深圳) 86-755-83298787  
[Http://www.100y.com.tw](http://www.100y.com.tw)

**Absolute Maximum Ratings** (Note 1, Note 2)

If Military/Aerospace specified devices are required, please contact the Texas Instruments Sales Office/ Distributors for availability and specifications.

$V_{IN}, V_{EN}$	-0.3 to 6.5V
$V_{OUT}$	-0.3 to $(V_{IN}+0.3) \leq 6.5V$
Junction Temperature	150°C
Storage Temperature	-65°C to +150°C
Lead Temp.	235°C
Pad Temp. (Note 3)	235°C

Maximum Power Dissipation	
SOT23-5 (Note 4)	364mW
micro SMD (Note 4)	314mW
ESD Rating (Note 5)	
Human Body Model	2kV
Machine Model	150V

**Operating Ratings** (Note 1, Note 2)

$V_{IN}$	2.5 to 6V
$V_{EN}$	0 to $(V_{IN}+0.3) \leq 6V$
Junction Temperature	-40°C to +125°C
Thermal Resistance	
$\theta_{JA}$ (SOT23-5)	220°C/W
$\theta_{JA}$ (micro SMD)	255°C/W
Maximum Power Dissipation	
SOT23-5 (Note 6)	250mW
micro SMD (Note 6)	216mW

**Electrical Characteristics**

Unless otherwise specified:  $V_{IN} = V_{OUT(nom)} + 0.5V$ ,  $C_{IN} = 1 \mu F$ ,  $I_{OUT} = 1mA$ ,  $C_{OUT} = 1 \mu F$ ,  $C_{BYPASS} = 0.01 \mu F$ . Typical values and limits appearing in standard typeface are for  $T_J = 25^\circ C$ . Limits appearing in **boldface type** apply over the entire junction temperature range for operation, -40°C to +125°C. (Note 7, Note 8)

Symbol	Parameter	Conditions	Typ	Limit		Units
				Min	Max	
$\Delta V_{OUT}$	Output Voltage Tolerance	$I_{OUT} = 1mA$		-2	2	% of $V_{OUT(nom)}$
	Line Regulation Error	$V_{IN} = (V_{OUT(nom)} + 0.5V)$ to 6.0V, For 4.7 to 5.0 options For all other options		-0.19	0.19	%/V
	Load Regulation Error (Note 9)	$I_{OUT} = 1mA$ to 150 mA LP3985IM5 (SOT23-5) LP3985 (micro SMD)	0.0025 0.0004		0.005 0.002	%/mA
	Output AC Line Regulation	$V_{IN} = V_{OUT(nom)} + 1V$ , $I_{OUT} = 150mA$ (Figure 1)	1.5			mV <sub>P-P</sub>
PSRR	Power Supply Rejection Ratio	$V_{IN} = V_{OUT(nom)} + 0.2V$ , $f = 1kHz$ , $I_{OUT} = 50mA$ (Figure 2)	50			dB
		$V_{IN} = V_{OUT(nom)} + 0.2V$ , $f = 10kHz$ , $I_{OUT} = 50mA$ (Figure 2)	40			
$I_Q$	Quiescent Current	$V_{EN} = 1.4V$ , $I_{OUT} = 0mA$ For 4.7 to 5.0 options For all other options	100 85		165 150	$\mu A$
		$V_{EN} = 1.4V$ , $I_{OUT} = 0$ to 150 mA For 4.7 to 5.0 options For all other options	155 140		250 200	
		$V_{EN} = 0.4V$	0.003		1.5	
	Dropout Voltage (Note 10)	$I_{OUT} = 1mA$	0.4		2	mV
		$I_{OUT} = 50mA$	20		35	
		$I_{OUT} = 100mA$	45		70	
		$I_{OUT} = 150mA$	60		100	
$I_{SC}$	Short Circuit Current Limit	Output Grounded (Steady State)	600			mA
$I_{OUT(PK)}$	Peak Output Current	$V_{OUT} \geq V_{OUT(nom)} - 5\%$	550	300		mA

Symbol	Parameter	Conditions	Typ	Limit		Units
				Min	Max	
$T_{ON}$	Turn-On Time (Note 11)	$C_{BYPASS} = 0.01 \mu F$	200			$\mu s$
$e_n$	Output Noise Voltage (Note 12)	$BW = 10 \text{ Hz to } 100 \text{ kHz},$ $C_{OUT} = 1 \mu F$	30			$\mu V_{rms}$
	Output Noise Density	$C_{BP} = 0$	230			$nV/\sqrt{Hz}$
$I_{EN}$	Maximum Input Current at EN	$V_{EN} = 0.4$ and $V_{IN} = 6.0$	$\pm 1$			nA
$V_{IL}$	Maximum Low Level Input Voltage at EN	$V_{IN} = 2.5$ to $6.0V$			<b>0.4</b>	V
$V_{IH}$	Minimum High Level Input Voltage at EN	$V_{IN} = 2.5$ to $6.0V$			<b>1.4</b>	V
TSD	Thermal Shutdown Temperature		160			$^{\circ}C$
	Thermal Shutdown Hysteresis		20			$^{\circ}C$

**Note 1:** Absolute Maximum Ratings are limits beyond which damage to the device may occur. Operating Ratings are conditions under which operation of the device is guaranteed. Operating Ratings do not imply guaranteed performance limits. For guaranteed performance limits and associated test conditions, see the Electrical Characteristics tables.

**Note 2:** All voltages are with respect to the potential at the GND pin.

**Note 3:** Additional information on lead temperature and pad temperature can be found in National Semiconductor Application Note (AN-1112).

**Note 4:** The Absolute Maximum power dissipation depends on the ambient temperature and can be calculated using the formula:  $P_D = (T_J - T_A)/\theta_{JA}$ , where  $T_J$  is the junction temperature,  $T_A$  is the ambient temperature, and  $\theta_{JA}$  is the junction-to-ambient thermal resistance. The 364mW rating for SOT23-5 appearing under Absolute Maximum Ratings results from substituting the Absolute Maximum junction temperature, 150 $^{\circ}C$ , for  $T_J$ , 70 $^{\circ}C$  for  $T_A$ , and 220 $^{\circ}C/W$  for  $\theta_{JA}$ . More power can be dissipated safely at ambient temperatures below 70 $^{\circ}C$ . Less power can be dissipated safely at ambient temperatures above 70 $^{\circ}C$ . The Absolute Maximum power dissipation can be increased by 4.5mW for each degree below 70 $^{\circ}C$ , and it must be derated by 4.5mW for each degree above 70 $^{\circ}C$ .

**Note 5:** The human body model is 100pF discharged through 1.5k $\Omega$  resistor into each pin. The machine model is a 200 pF capacitor discharged directly into each pin.

**Note 6:** Like the Absolute Maximum power dissipation, the maximum power dissipation for operation depends on the ambient temperature. The 250mW rating for SOT23-5 appearing under Operating Ratings results from substituting the maximum junction temperature for operation, 125 $^{\circ}C$ , for  $T_J$ , 70 $^{\circ}C$  for  $T_A$ , and 220 $^{\circ}C/W$  for  $\theta_{JA}$  into (Note 4) above. More power can be dissipated at ambient temperatures below 70 $^{\circ}C$ . Less power can be dissipated at ambient temperatures above 70 $^{\circ}C$ . The maximum power dissipation for operation can be increased by 4.5mW for each degree below 70 $^{\circ}C$ , and it must be derated by 4.5mW for each degree above 70 $^{\circ}C$ .

**Note 7:** All limits are guaranteed. All electrical characteristics having room-temperature limits are tested during production with  $T_J = 25^{\circ}C$  or correlated using Statistical Quality Control (SQC) methods. All hot and cold limits are guaranteed by correlating the electrical characteristics to process and temperature variations and applying statistical process control.

**Note 8:** The target output voltage, which is labeled  $V_{OUT(nom)}$ , is the desired voltage option.

**Note 9:** An increase in the load current results in a slight decrease in the output voltage and vice versa.

**Note 10:** Dropout voltage is the input-to-output voltage difference at which the output voltage is 100mV below its nominal value. This specification does not apply for input voltages below 2.5V.

**Note 11:** Turn-on time is time measured between the enable input just exceeding  $V_{IH}$  and the output voltage just reaching 95% of its nominal value.

**Note 12:** The output noise varies with output voltage option. The 30 $\mu V_{rms}$  is measured with 2.5V voltage option. To calculate an approximated output noise for other options, use the equation:  $(30\mu V_{rms})(X)/2.5$ , where X is the voltage option value.

## Recommended Output Capacitor

Symbol	Parameter	Conditions	Nominal Value	Limit		Units
				Min	Max	
$C_{OUT}$	Output Capacitor	Capacitance (Note 13)	1.0	<b>0.7</b>		$\mu F$
		ESR		<b>5</b>	<b>500</b>	m $\Omega$

**Note 13:** The minimum value of capacitance for stability and correct operation is 0.7 $\mu F$ . The Capacitor tolerance should be  $\pm 30\%$  or better over the temperature range. The full range of operating conditions for the capacitor in the application should be considered during device selection to ensure this minimum capacitance specification is met. The recommended capacitor type is X7R to meet the full device temperature spec of -40 $^{\circ}C$  to 125 $^{\circ}C$ . See the capacitor section in Application Hints.

勝特力材料 886-3-5753170  
 勝特力电子(上海) 86-21-34970699  
 勝特力电子(深圳) 86-755-83298787  
[Http://www.100y.com.tw](http://www.100y.com.tw)

## Timing Diagrams

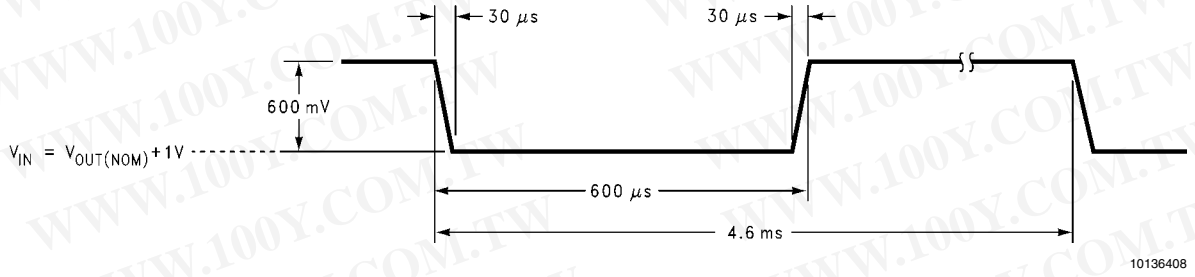

FIGURE 1. Line Transient Input Test Signal

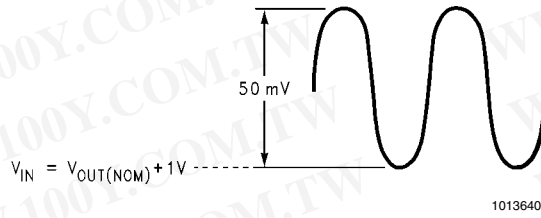
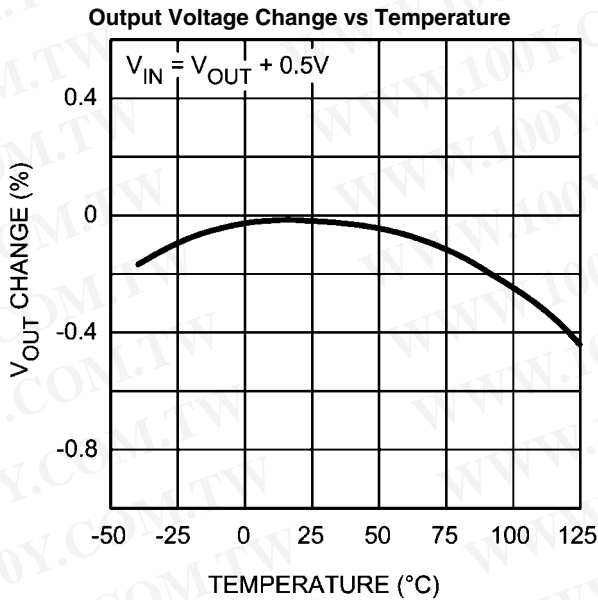
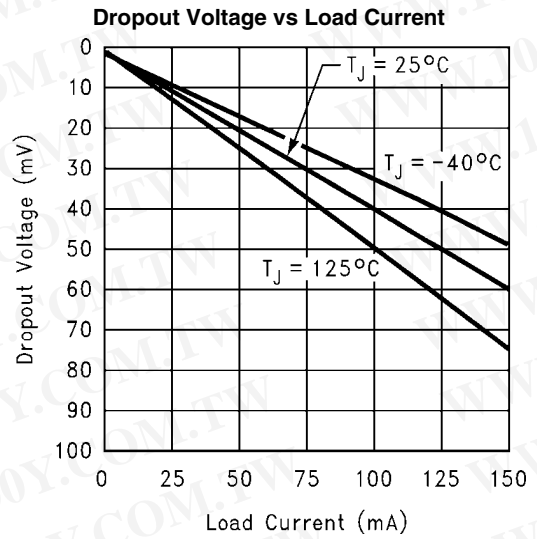

FIGURE 2. PSRR Input Test Signal

**Typical Performance Characteristics** Unless otherwise specified,  $C_{IN} = C_{OUT} = 1 \mu F$  Ceramic,  $C_{BYPASS} = 0.01 \mu F$ ,  $V_{IN} = V_{OUT} + 0.2V$ ,  $T_A = 25^\circ C$ , Enable pin is tied to  $V_{IN}$ .



10136441



10136433

勝特力材料 886-3-5753170  
 勝特力电子(上海) 86-21-34970699  
 勝特力电子(深圳) 86-755-83298787  
[Http://www.100y.com.tw](http://www.100y.com.tw)

**Ground Current vs Load Current**

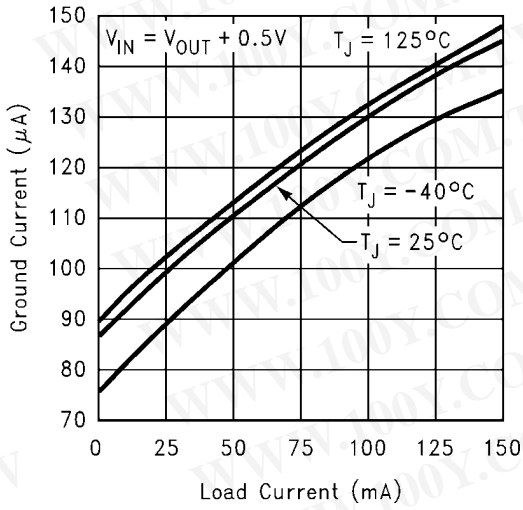

10136440

**Ground Current vs  $V_{IN}$  @ 25°C**

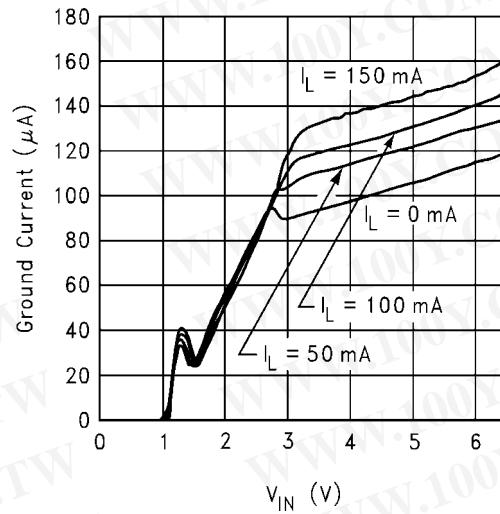

10136435

**Ground Current vs  $V_{IN}$  @ -40°C**

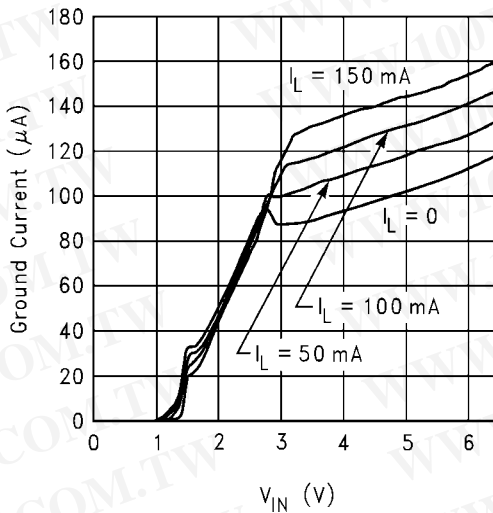

10136437

**Ground Current vs  $V_{IN}$  @ 125°C**

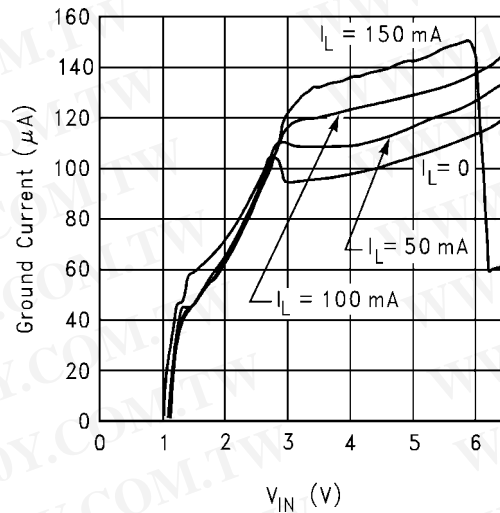

10136439

**Short Circuit Current (micro SMD)**

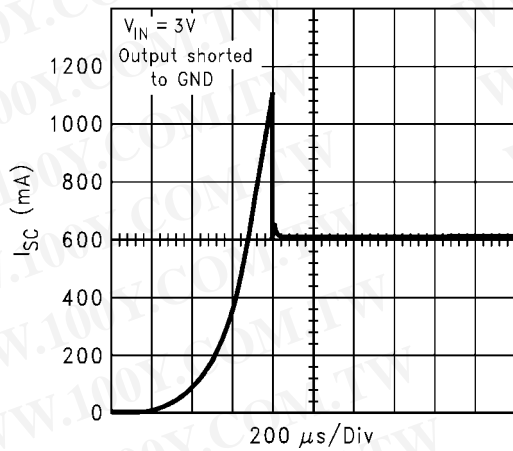

10136445

**Short Circuit Current (micro SMD)**

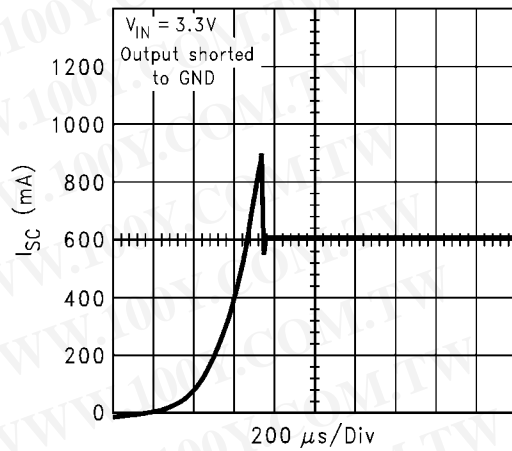

10136446

勝特力材料 886-3-5753170  
 勝特力电子(上海) 86-21-34970699  
 勝特力电子(深圳) 86-755-83298787  
[Http://www.100y.com.tw](http://www.100y.com.tw)

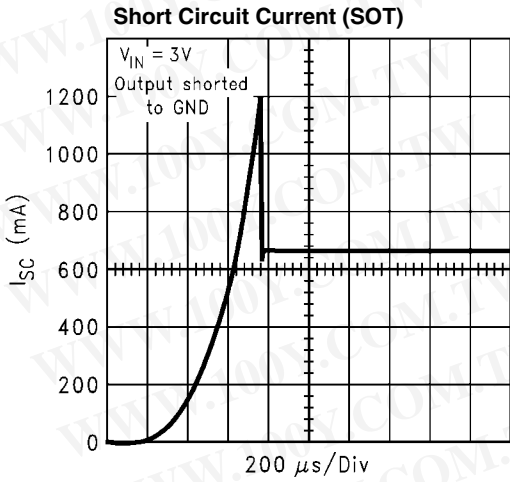

10136447

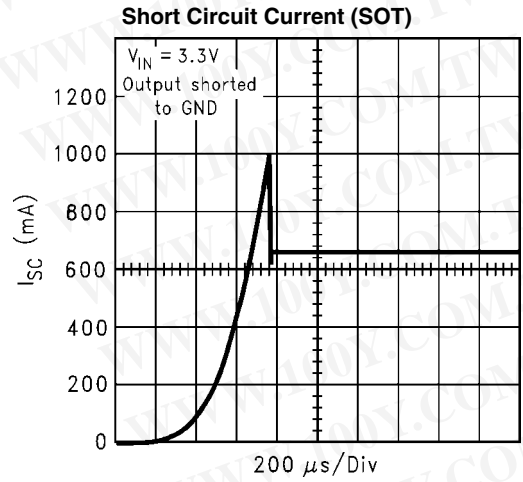

10136448

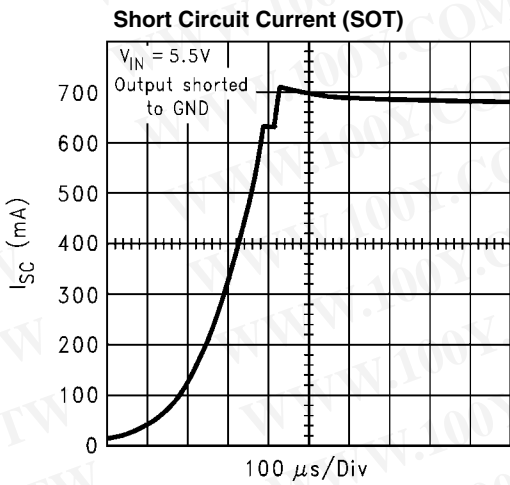

10136449

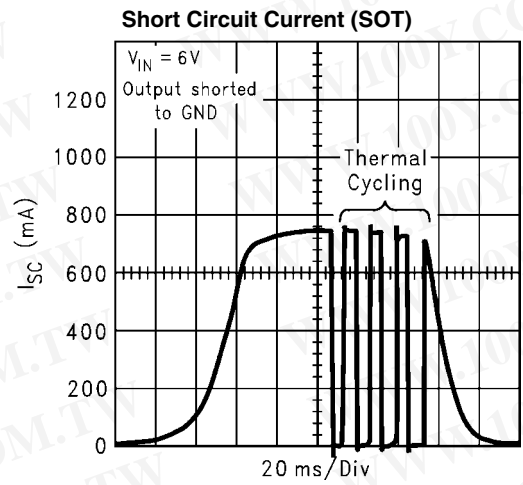

10136450

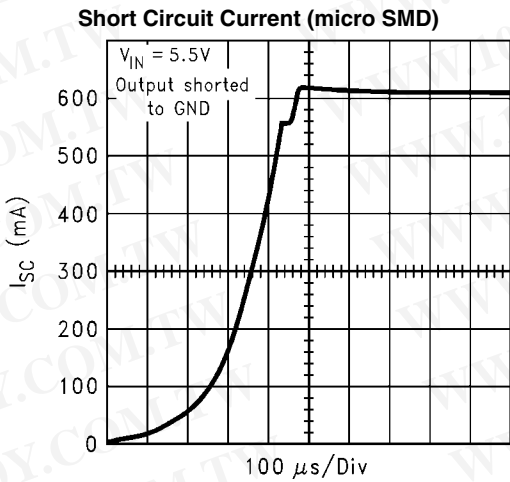

10136451

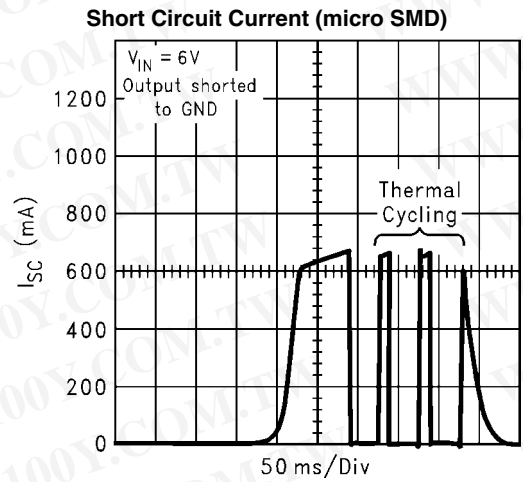

10136452

勝特力材料 886-3-5753170  
 勝特力电子(上海) 86-21-34970699  
 勝特力电子(深圳) 86-755-83298787  
[Http://www.100y.com.tw](http://www.100y.com.tw)

**Output Noise Spectral Density**

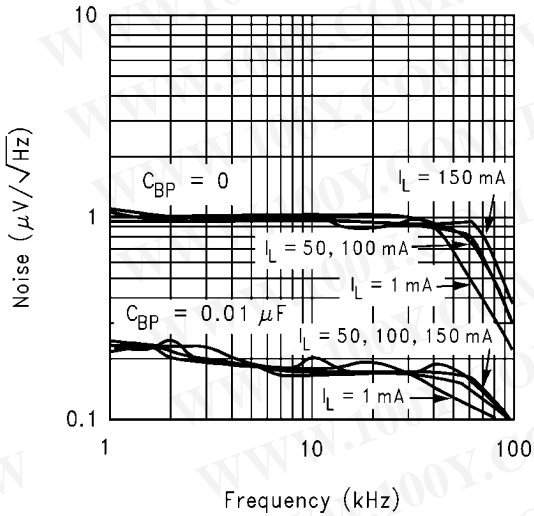

10136410

**Ripple Rejection ( $V_{IN} = V_{OUT} + 0.2V$ )**

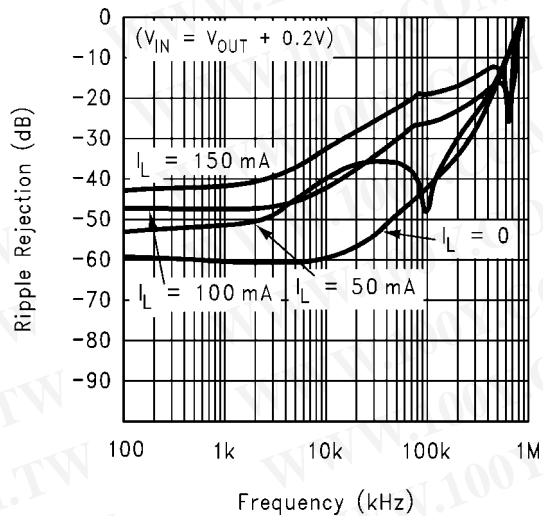

10136411

**Ripple Rejection ( $V_{IN} = V_{OUT} + 1V$ )**

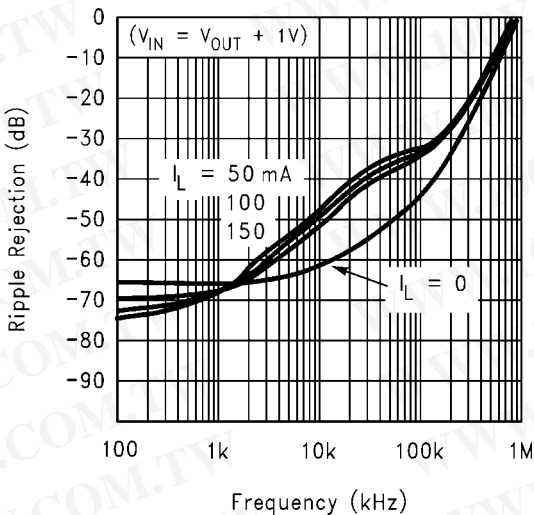

10136412

**Ripple Rejection ( $V_{IN} = 5.0V$ )**

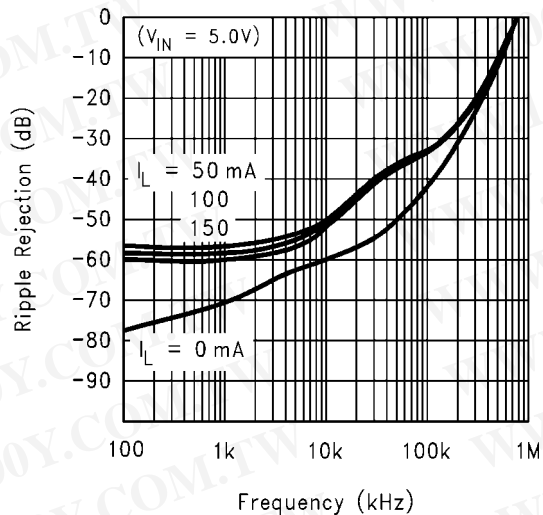

10136413

**Startup Time ( $V_{IN} = V_{OUT} + 0.2V$ )**

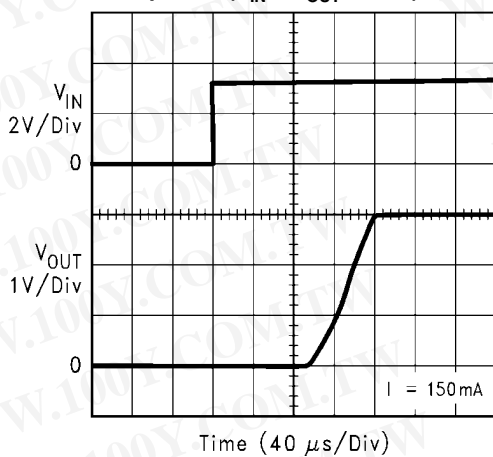

10136414

**Startup Time ( $V_{IN} = 4.2V$ )**

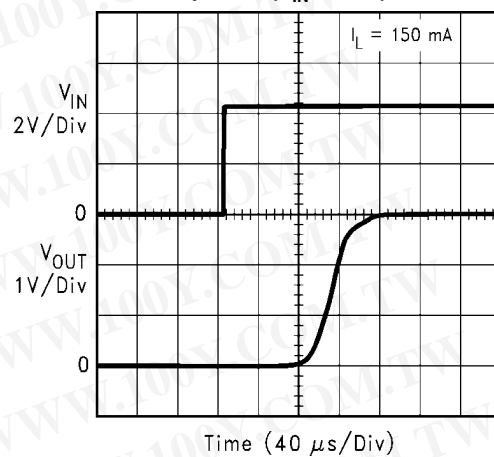

10136415

勝特力材料 886-3-5753170  
 勝特力电子(上海) 86-21-34970699  
 勝特力电子(深圳) 86-755-83298787  
[Http://www.100y.com.tw](http://www.100y.com.tw)

Startup Time ( $V_{IN} = V_{OUT} + 0.2V$ )

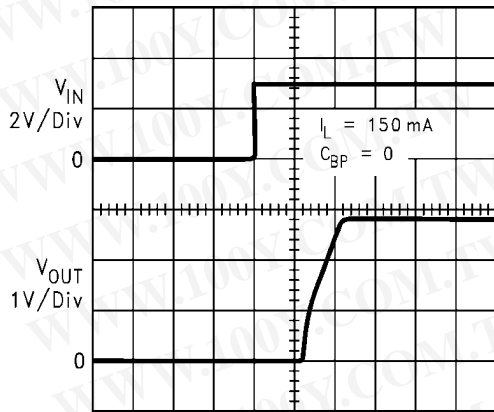

Time (20  $\mu\text{s}/\text{Div}$ )

10136416

Startup Time ( $V_{IN} = 4.2V$ )

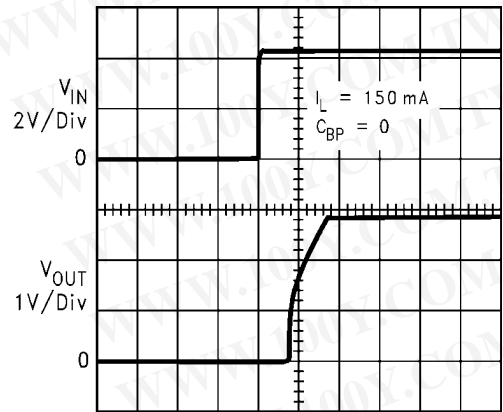

Time (20  $\mu\text{s}/\text{Div}$ )

10136417

Startup Time ( $V_{IN} = V_{OUT} + 0.2V$ )

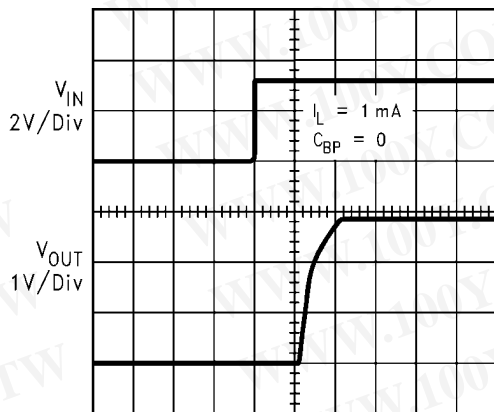

Time (20  $\mu\text{s}/\text{Div}$ )

10136418

Startup Time ( $V_{IN} = 4.2V$ )

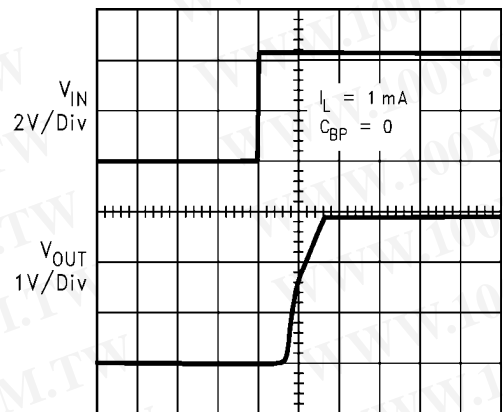

Time (20  $\mu\text{s}/\text{Div}$ )

10136419

Line Transient Response

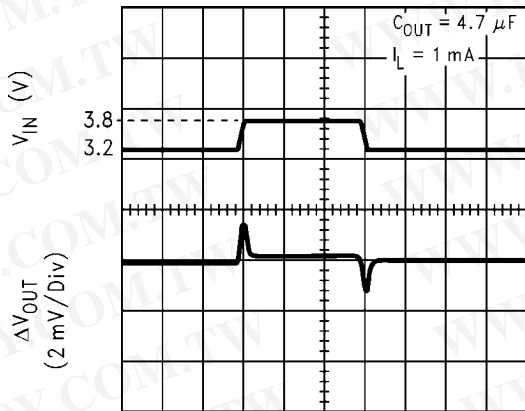

Time (200  $\mu\text{s}/\text{Div}$ )

10136420

Line Transient Response

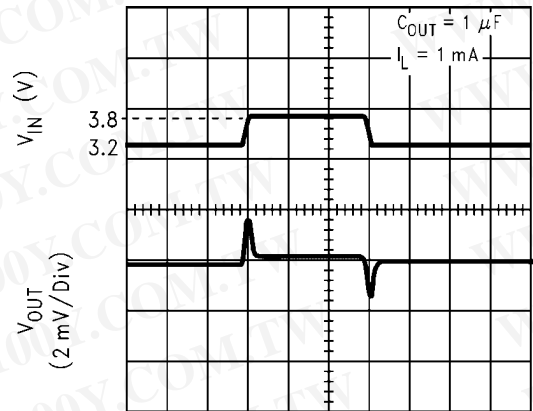

Time (200  $\mu\text{s}/\text{Div}$ )

10136421

勝特力材料 886-3-5753170  
 勝特力电子(上海) 86-21-34970699  
 勝特力电子(深圳) 86-755-83298787  
[Http://www.100y.com.tw](http://www.100y.com.tw)

Load Transient Response ( $V_{IN} = 3.2V$ )

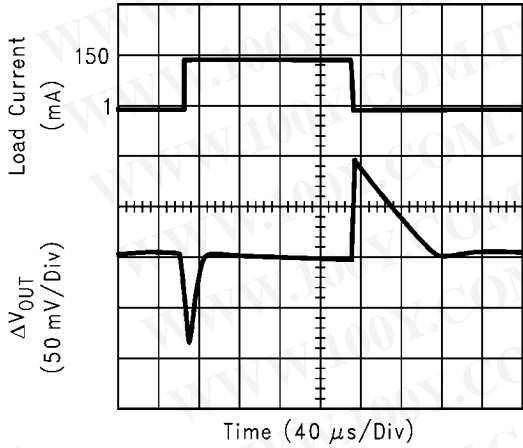

10136423

Load Transient Response ( $V_{IN} = 4.2V$ )

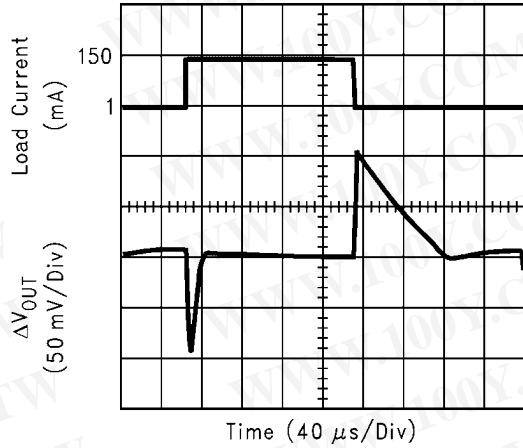

10136422

Load Transient Response ( $V_{IN} = 3.2V$ )

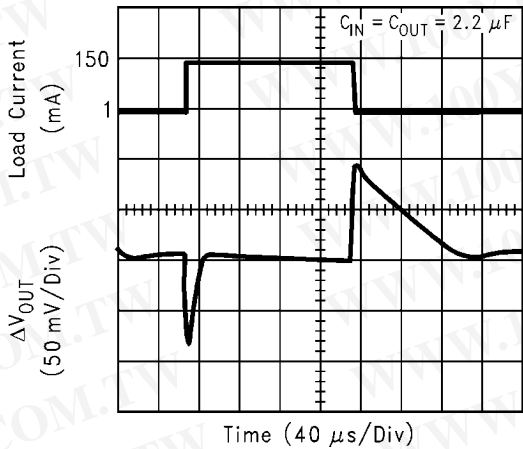

10136424

Load Transient Response ( $V_{IN} = 4.2V$ )

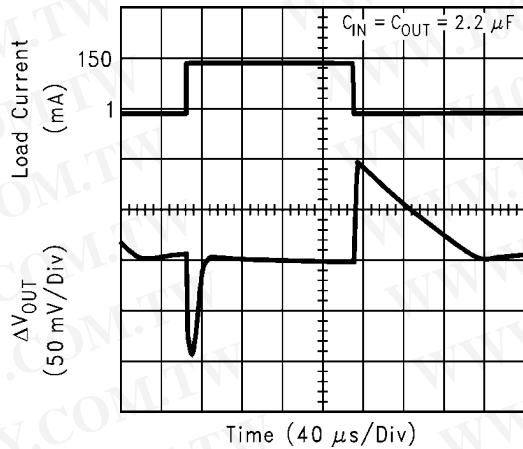

10136425

Enable Response ( $V_{IN} = V_{OUT} + 0.2V$ )

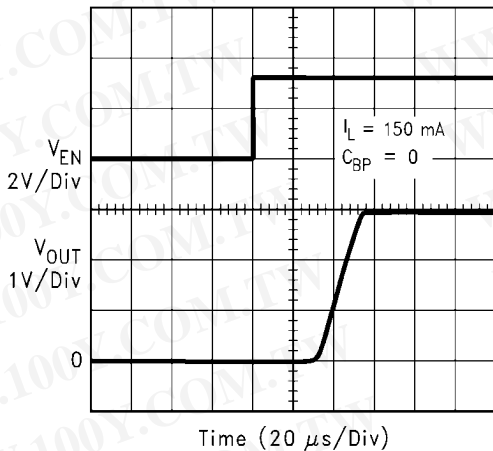

10136453

Enable Response ( $V_{IN} = 4.2V$ )

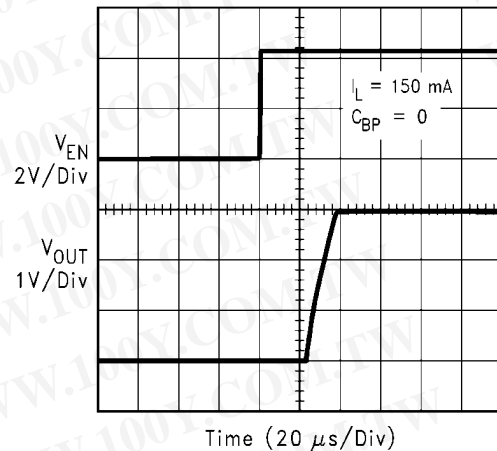

10136454

勝特力材料 886-3-5753170  
 勝特力电子(上海) 86-21-34970699  
 勝特力电子(深圳) 86-755-83298787  
[Http://www.100y.com.tw](http://www.100y.com.tw)

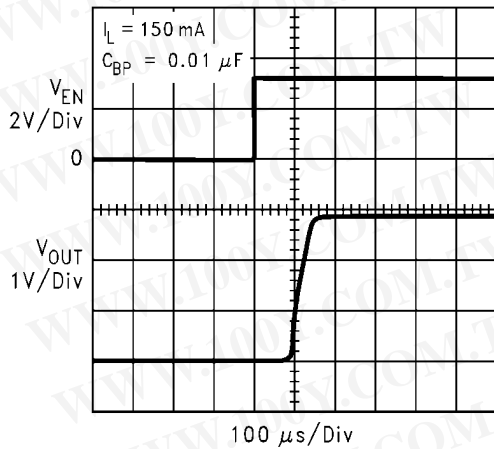
Enable Response ( $V_{IN} = V_{OUT} + 0.2V$ )

10136455

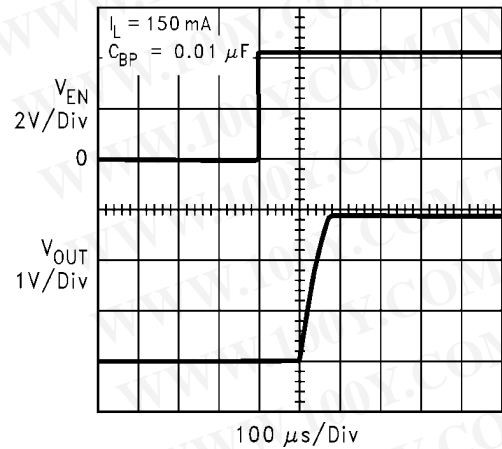
Enable Response ( $V_{IN} = 4.2V$ )

10136456

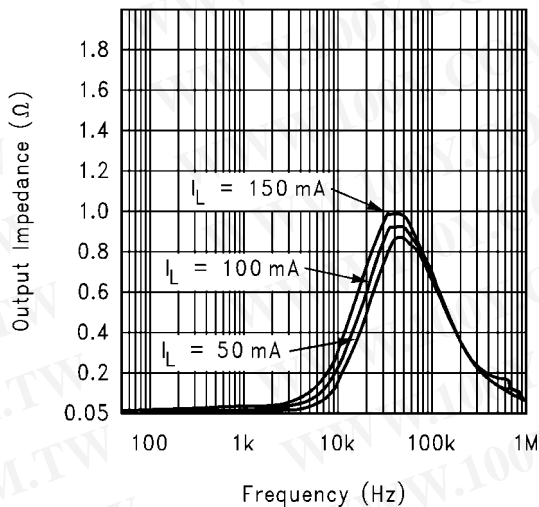
Output Impedance ( $V_{IN} = 4.2V$ )

10136465

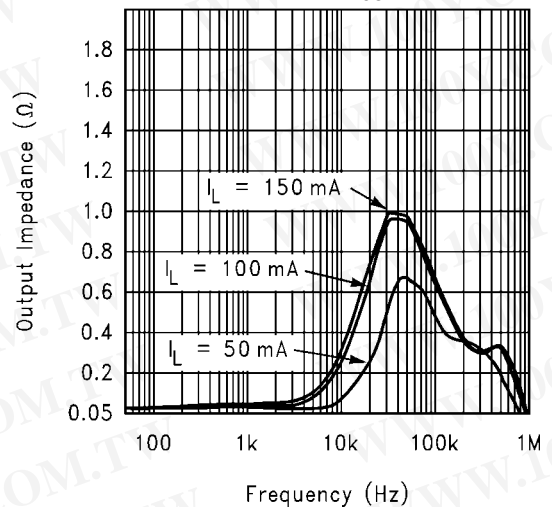
Output Impedance ( $V_{IN} = V_{OUT} + 0.2V$ )

10136466

## Application Hints

### EXTERNAL CAPACITORS

Like any low-dropout regulator, the LP3985 requires external capacitors for regulator stability. The LP3985 is specifically designed for portable applications requiring minimum board space and smallest components. These capacitors must be correctly selected for good performance.

### INPUT CAPACITOR

An input capacitance of  $\approx 1\mu F$  is required between the LP3985 input pin and ground (the amount of the capacitance may be increased without limit).

This capacitor must be located a distance of not more than 1cm from the input pin and returned to a clean analog ground. A ceramic capacitor is recommended although a good quality tantalum or film capacitor may be used at the input.

**Important:** Tantalum capacitors can suffer catastrophic failures due to surge current when connected to a low-impedance source of power (like a battery or a very large capacitor). If a tantalum capacitor is used at the input, it must be guaranteed by the manufacturer to have a surge current rating sufficient for the application.

There are no requirements for the ESR on the input capacitor, but tolerance and temperature coefficient must be considered when selecting the capacitor to ensure the capacitance will remain within the operational range over the full range of temperature and operating conditions.

### OUTPUT CAPACITOR

Correct selection of the output capacitor is important to ensure stable operation in the intended application.

The output capacitor must meet all the requirements specified in the recommended capacitor table over all conditions in the application. These conditions include DC-bias, frequency and temperature. Unstable operation will result if the capacitance drops below the minimum specified value. (See the next section Capacitor Characteristics).

The LP3985 is designed specifically to work with very small ceramic output capacitors. A  $1.0\mu F$  ceramic capacitor (dielectric type X7R) with ESR between  $5m\Omega$  to  $500m\Omega$  is suitable in the LP3985 application circuit. X5R capacitors may be used but have a narrower temperature range. With these and other capacitor types (Y5V, Z6U) that may be used, selection is dependant on the range of operating conditions and temperature range for that application. (see section on Capacitor Characteristics).

It may also be possible to use tantalum or film capacitors at the output, but these are not as attractive for reasons of size and cost (see next section Capacitor Characteristics).

It is also recommended that the output capacitor be placed within 1cm from the output pin and returned to a clean ground line.

### CAPACITOR CHARACTERISTICS

The LP3985 is designed to work with ceramic capacitors on the output to take advantage of the benefits they offer: for capacitance values in the range of 1 $\mu$ F to 4.7 $\mu$ F range, ceramic capacitors are the smallest, least expensive and have the lowest ESR values (which makes them best for eliminating high frequency noise). The ESR of a typical 1 $\mu$ F ceramic capacitor is in the range of 20m $\Omega$  to 40m $\Omega$ , which easily meets the ESR requirement for stability by the LP3985.

For both input and output capacitors careful interpretation of the capacitor specification is required to ensure correct device operation. The capacitor value can change greatly dependant on the conditions of operation and capacitor type.

In particular the output capacitor selection should take account of all the capacitor parameters to ensure that the specification is met within the application. Capacitance value can vary with DC bias conditions as well as temperature and frequency of operation. Capacitor values will also show some decrease over time due to aging. The capacitor parameters are also dependant on the particular case size with smaller sizes giving poorer performance figures in general. As an example *Figure 3* shows a typical graph showing a comparison of capacitor case sizes in a Capacitance vs. DC Bias plot. As shown in the graph, as a result of the DC Bias condition the capacitance value may drop below the minimum capacitance value given in the recommended capacitor table (0.7 $\mu$ F in this case). Note that the graph shows the capacitance out of spec for the 0402 case size capacitor at higher bias voltages. It is therefore recommended that the capacitor manufacturers' specifications for the nominal value capacitor are consulted for all conditions as some capacitor sizes (e.g. 0402) may not be suitable in the actual application.

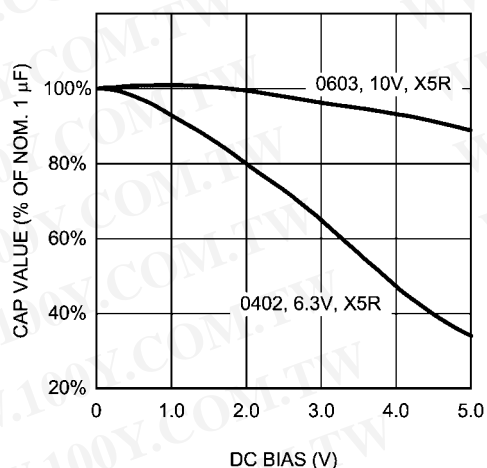

**FIGURE 3. Graph Showing A Typical Variation in Capacitance vs DC Bias**

The ceramic capacitor's capacitance can vary with temperature. The capacitor type X7R, which operates over a temperature range of  $-55^{\circ}\text{C}$  to  $+125^{\circ}\text{C}$ , will only vary the capacitance to within  $\pm 15\%$ . The capacitor type X5R has a similar toler-

ance over a reduced temperature range of  $-55^{\circ}\text{C}$  to  $+85^{\circ}\text{C}$ . Most large value ceramic capacitors ( $\approx 2.2\mu\text{F}$ ) are manufactured with Z5U or Y5V temperature characteristics. Their capacitance can drop by more than 50% as the temperature goes from  $25^{\circ}\text{C}$  to  $85^{\circ}\text{C}$ . Therefore X7R is recommended over Z5U and Y5V in applications where the ambient temperature will change significantly above or below  $25^{\circ}\text{C}$ .

Tantalum capacitors are less desirable than ceramic for use as output capacitors because they are more expensive when comparing equivalent capacitance and voltage ratings in the 1 $\mu$ F to 4.7 $\mu$ F range.

Another important consideration is that tantalum capacitors have higher ESR values than equivalent size ceramics. This means that while it may be possible to find a tantalum capacitor with an ESR value within the stable range, it would have to be larger in capacitance (which means bigger and more costly) than a ceramic capacitor with the same ESR value. It should also be noted that the ESR of a typical tantalum will increase about 2:1 as the temperature goes from  $25^{\circ}\text{C}$  down to  $-40^{\circ}\text{C}$ , so some guard band must be allowed.

### NOISE BYPASS CAPACITOR

Connecting a 0.01 $\mu$ F capacitor between the  $C_{\text{BYPASS}}$  pin and ground significantly reduces noise on the regulator output. This cap is connected directly to a high impedance node in the band gap reference circuit. Any significant loading on this node will cause a change on the regulated output voltage. For this reason, DC leakage current through this pin must be kept as low as possible for best output voltage accuracy.

The types of capacitors best suited for the noise bypass capacitor are ceramic and film. High-quality ceramic capacitors with either NPO or COG dielectric typically have very low leakage. Polypropylene and polycarbonate film capacitors are available in small surface-mount packages and typically have extremely low leakage current.

Unlike many other LDO's, addition of a noise reduction capacitor does not effect the load transient response of the device.

### NO-LOAD STABILITY

The LP3985 will remain stable and in regulation with no external load. This is specially important in CMOS RAM keep-alive applications.

### ON/OFF INPUT OPERATION

The LP3985 is turned off by pulling the  $V_{\text{EN}}$  pin low, and turned on by pulling it high. If this feature is not used, the  $V_{\text{EN}}$  pin should be tied to  $V_{\text{IN}}$  to keep the regulator output on at all time. To assure proper operation, the signal source used to drive the  $V_{\text{EN}}$  input must be able to swing above and below the specified turn-on/off voltage thresholds listed in the Electrical Characteristics section under  $V_{\text{IL}}$  and  $V_{\text{IH}}$ .

### FAST ON-TIME

The LP3985 output is turned on after  $V_{\text{ref}}$  voltage reaches its final value (1.23V nominal). To speed up this process, the noise reduction capacitor at the bypass pin is charged with an internal 70 $\mu\text{A}$  current source. The current source is turned off when the bandgap voltage reaches approximately 95% of its final value. The turn on time is determined by the time constant of the bypass capacitor. The smaller the capacitor value, the shorter the turn on time, but less noise gets reduced. As a result, turn on time and noise reduction need to be taken into design consideration when choosing the value of the bypass capacitor.

勝特力材料 886-3-5753170  
 勝特力电子(上海) 86-21-34970699  
 勝特力电子(深圳) 86-755-83298787  
[Http://www.100y.com.tw](http://www.100y.com.tw)

**micro SMD MOUNTING**

The micro SMD package requires specific mounting techniques which are detailed in Texas Instruments Application Note (AN-1112). Referring to the section *Surface Mount Technology (SMT) Assembly Considerations*, it should be noted that the pad style which must be used with the 5-bump package is NSMD (non-solder mask defined) type.

For best results during assembly, alignment ordinals on the PC board may be used to facilitate placement of the micro SMD device.

**micro SMD LIGHT SENSITIVITY**

Exposing the micro SMD device to direct sunlight will cause mis-operation of the device. Light sources such as halogen

lamps can effect electrical performance if brought near to the device.

The wavelengths which have most detrimental effect are reds and infra-reds, which means that the fluorescent lighting used inside most buildings has very little effect on performance. A micro SMD test board was brought to within 1cm of a fluorescent desk lamp and the effect on the regulated output voltage was negligible, showing a deviation of less than 0.1% from nominal.

勝特力材料 886-3-5753170  
勝特力电子(上海) 86-21-34970699  
勝特力电子(深圳) 86-755-83298787  
[Http://www.100y.com.tw](http://www.100y.com.tw)

**Physical Dimensions** inches (millimeters) unless otherwise noted

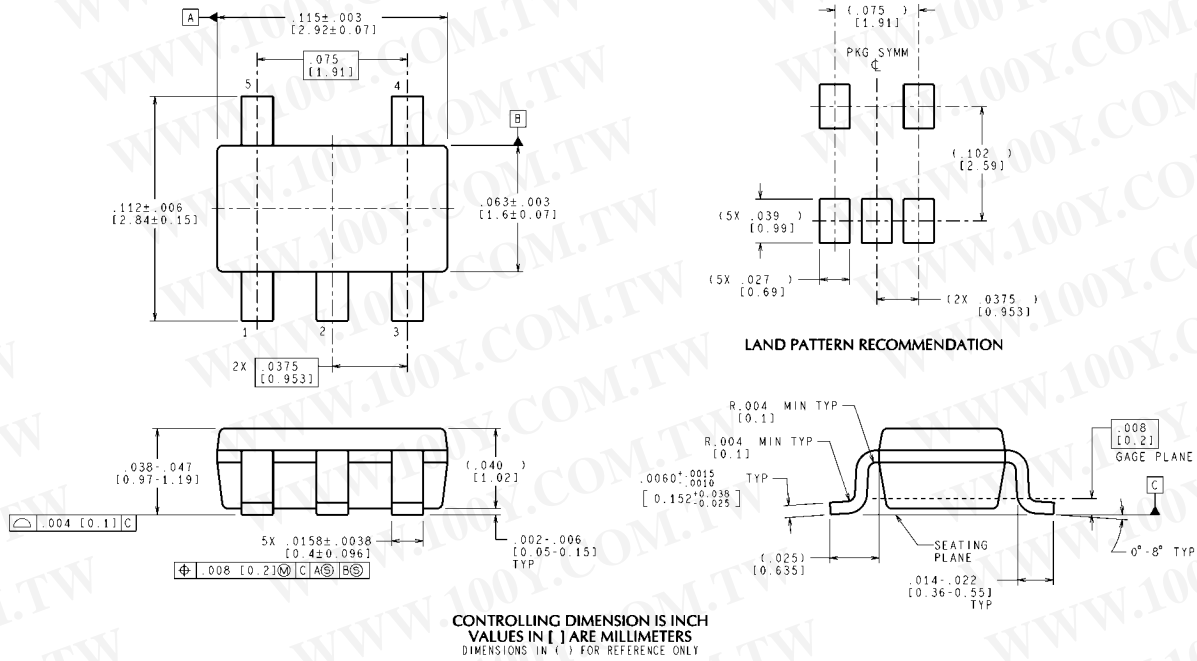

**5-Lead Small Outline Package (MF)  
NS Package Number MF05A**

MF05A (Rev D)

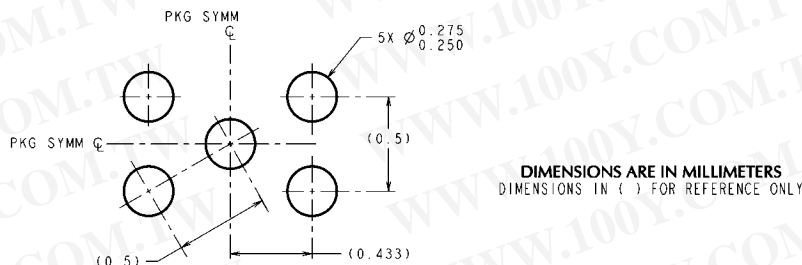

**LAND PATTERN RECOMMENDATION**

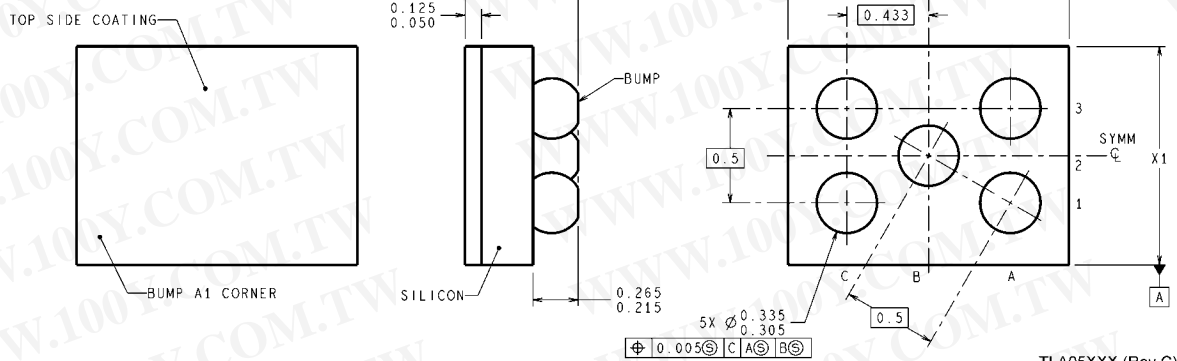

**thin micro SMD, 5 Bump, Package (TLA05)  
NS Package Number TLA05AEA**

TLA05XXX (Rev C)

The dimensions for X1, X2 and X3 are as given:  
**X1 = 1.006 ± 0.03mm**  
**X2 = 1.463 ± 0.03mm**  
**X3 = 0.6 ± 0.075mm**

勝特力材料 886-3-5753170  
 勝特力电子(上海) 86-21-34970699  
 勝特力电子(深圳) 86-755-83298787  
[Http://www.100y.com.tw](http://www.100y.com.tw)

## Notes

勝特力材料 886-3-5753170  
 勝特力电子(上海) 86-21-34970699  
 勝特力电子(深圳) 86-755-83298787  
[Http://www.100y.com.tw](http://www.100y.com.tw)

### TI/NATIONAL INTERIM IMPORTANT NOTICE

Texas Instruments has purchased National Semiconductor. As of Monday, September 26th, and until further notice, products sold or advertised under the National Semiconductor name or logo, and information, support and interactions concerning such products, remain subject to the preexisting National Semiconductor standard terms and conditions of sale, terms of use of website, and Notices (and/or terms previously agreed in writing with National Semiconductor, where applicable) and are not subject to any differing terms and notices applicable to other TI components, sales or websites. To the extent information on official TI and National websites and business social networking media, etc., pertains to both TI and National-branded products, both companies' instructions, warnings and limitations in the above-referenced terms of use apply.

Following are URLs where you can obtain information on other Texas Instruments products and application solutions:

Products		Applications	
Audio	<a href="http://www.ti.com/audio">www.ti.com/audio</a>	Communications and Telecom	<a href="http://www.ti.com/communications">www.ti.com/communications</a>
Amplifiers	<a href="http://amplifier.ti.com">amplifier.ti.com</a>	Computers and Peripherals	<a href="http://www.ti.com/computers">www.ti.com/computers</a>
Data Converters	<a href="http://dataconverter.ti.com">dataconverter.ti.com</a>	Consumer Electronics	<a href="http://www.ti.com/consumer-apps">www.ti.com/consumer-apps</a>
DLP® Products	<a href="http://www.dlp.com">www.dlp.com</a>	Energy and Lighting	<a href="http://www.ti.com/energy">www.ti.com/energy</a>
DSP	<a href="http://dsp.ti.com">dsp.ti.com</a>	Industrial	<a href="http://www.ti.com/industrial">www.ti.com/industrial</a>
Clocks and Timers	<a href="http://www.ti.com/clocks">www.ti.com/clocks</a>	Medical	<a href="http://www.ti.com/medical">www.ti.com/medical</a>
Interface	<a href="http://interface.ti.com">interface.ti.com</a>	Security	<a href="http://www.ti.com/security">www.ti.com/security</a>
Logic	<a href="http://logic.ti.com">logic.ti.com</a>	Space, Avionics and Defense	<a href="http://www.ti.com/space-avionics-defense">www.ti.com/space-avionics-defense</a>
Power Mgmt	<a href="http://power.ti.com">power.ti.com</a>	Transportation and Automotive	<a href="http://www.ti.com/automotive">www.ti.com/automotive</a>
Microcontrollers	<a href="http://microcontroller.ti.com">microcontroller.ti.com</a>	Video and Imaging	<a href="http://www.ti.com/video">www.ti.com/video</a>
RFID	<a href="http://www.ti-rfid.com">www.ti-rfid.com</a>	Wireless	<a href="http://www.ti.com/wireless-apps">www.ti.com/wireless-apps</a>
RF/IF and ZigBee® Solutions	<a href="http://www.ti.com/lprf">www.ti.com/lprf</a>	<b>TI E2E Community Home Page</b>	<a href="http://e2e.ti.com">e2e.ti.com</a>

Mailing Address: Texas Instruments, Post Office Box 655303, Dallas, Texas 75265

Copyright© 2011 Texas Instruments Incorporated

## IMPORTANT NOTICE

Texas Instruments Incorporated and its subsidiaries (TI) reserve the right to make corrections, modifications, enhancements, improvements, and other changes to its products and services at any time and to discontinue any product or service without notice. Customers should obtain the latest relevant information before placing orders and should verify that such information is current and complete. All products are sold subject to TI's terms and conditions of sale supplied at the time of order acknowledgment.

TI warrants performance of its hardware products to the specifications applicable at the time of sale in accordance with TI's standard warranty. Testing and other quality control techniques are used to the extent TI deems necessary to support this warranty. Except where mandated by government requirements, testing of all parameters of each product is not necessarily performed.

TI assumes no liability for applications assistance or customer product design. Customers are responsible for their products and applications using TI components. To minimize the risks associated with customer products and applications, customers should provide adequate design and operating safeguards.

TI does not warrant or represent that any license, either express or implied, is granted under any TI patent right, copyright, mask work right, or other TI intellectual property right relating to any combination, machine, or process in which TI products or services are used. Information published by TI regarding third-party products or services does not constitute a license from TI to use such products or services or a warranty or endorsement thereof. Use of such information may require a license from a third party under the patents or other intellectual property of the third party, or a license from TI under the patents or other intellectual property of TI.

Reproduction of TI information in TI data books or data sheets is permissible only if reproduction is without alteration and is accompanied by all associated warranties, conditions, limitations, and notices. Reproduction of this information with alteration is an unfair and deceptive business practice. TI is not responsible or liable for such altered documentation. Information of third parties may be subject to additional restrictions.

Resale of TI products or services with statements different from or beyond the parameters stated by TI for that product or service voids all express and any implied warranties for the associated TI product or service and is an unfair and deceptive business practice. TI is not responsible or liable for any such statements.

TI products are not authorized for use in safety-critical applications (such as life support) where a failure of the TI product would reasonably be expected to cause severe personal injury or death, unless officers of the parties have executed an agreement specifically governing such use. Buyers represent that they have all necessary expertise in the safety and regulatory ramifications of their applications, and acknowledge and agree that they are solely responsible for all legal, regulatory and safety-related requirements concerning their products and any use of TI products in such safety-critical applications, notwithstanding any applications-related information or support that may be provided by TI. Further, Buyers must fully indemnify TI and its representatives against any damages arising out of the use of TI products in such safety-critical applications.

TI products are neither designed nor intended for use in military/aerospace applications or environments unless the TI products are specifically designated by TI as military-grade or "enhanced plastic." Only products designated by TI as military-grade meet military specifications. Buyers acknowledge and agree that any such use of TI products which TI has not designated as military-grade is solely at the Buyer's risk, and that they are solely responsible for compliance with all legal and regulatory requirements in connection with such use.

TI products are neither designed nor intended for use in automotive applications or environments unless the specific TI products are designated by TI as compliant with ISO/TS 16949 requirements. Buyers acknowledge and agree that, if they use any non-designated products in automotive applications, TI will not be responsible for any failure to meet such requirements.

Following are URLs where you can obtain information on other Texas Instruments products and application solutions:

### Products

Audio [www.ti.com/audio](http://www.ti.com/audio)  
Amplifiers [amplifier.ti.com](http://amplifier.ti.com)  
Data Converters [dataconverter.ti.com](http://dataconverter.ti.com)  
DLP® Products [www.dlp.com](http://www.dlp.com)  
DSP [dsp.ti.com](http://dsp.ti.com)  
Clocks and Timers [www.ti.com/clocks](http://www.ti.com/clocks)  
Interface [interface.ti.com](http://interface.ti.com)  
Logic [logic.ti.com](http://logic.ti.com)  
Power Mgmt [power.ti.com](http://power.ti.com)  
Microcontrollers [microcontroller.ti.com](http://microcontroller.ti.com)  
RFID [www.ti-rfid.com](http://www.ti-rfid.com)  
OMAP Mobile Processors [www.ti.com/omap](http://www.ti.com/omap)  
Wireless Connectivity [www.ti.com/wirelessconnectivity](http://www.ti.com/wirelessconnectivity)

### Applications

Communications and Telecom [www.ti.com/communications](http://www.ti.com/communications)  
Computers and Peripherals [www.ti.com/computers](http://www.ti.com/computers)  
Consumer Electronics [www.ti.com/consumer-apps](http://www.ti.com/consumer-apps)  
Energy and Lighting [www.ti.com/energy](http://www.ti.com/energy)  
Industrial [www.ti.com/industrial](http://www.ti.com/industrial)  
Medical [www.ti.com/medical](http://www.ti.com/medical)  
Security [www.ti.com/security](http://www.ti.com/security)  
Space, Avionics and Defense [www.ti.com/space-avionics-defense](http://www.ti.com/space-avionics-defense)  
Transportation and Automotive [www.ti.com/automotive](http://www.ti.com/automotive)  
Video and Imaging [www.ti.com/video](http://www.ti.com/video)

TI E2E Community Home Page

[e2e.ti.com](http://e2e.ti.com)

Mailing Address: Texas Instruments, Post Office Box 655303, Dallas, Texas 75265  
Copyright © 2011, Texas Instruments Incorporated

勝特力材料 886-3-5753170  
勝特力电子(上海) 86-21-34970699  
勝特力电子(深圳) 86-755-83298787  
[Http://www.100y.com.tw](http://www.100y.com.tw)