

LP2954, LP2954A 5-V and Adjustable Micropower LDOs

1 Features

- 5-V Output within 1.2% Over Temperature (A Grade)
- Adjustable 1.23-V to 29-V Output Voltage Available (LP2954IM and LP2954AIM)
- Ensured 250-mA Output Current
- Extremely Low Quiescent Current
- Low Dropout Voltage
- Reverse Battery Protection
- Extremely Tight Line and Load Regulation
- Very Low Temperature Coefficient
- Current and Thermal Limiting
- Pin Compatible with LM2940 and LM340 (5-V Version Only)
- Adjustable Version Adds $\overline{\text{ERROR}}$ Flag to Warn of Output Drop and a Logic-Controlled Shutdown

2 Applications

- High-Efficiency Linear Regulator
- Low Dropout Battery-Powered Regulator

勝特力電材超市-龍山店 886-3-5773766
 勝特力電材超市-光復店 886-3-5729570
 勝特力電子(上海) 86-21-34970699
 勝特力電子(深圳) 86-755-83298787
<http://www.100y.com.tw>

3 Description

The LP2954 is a 5-V micropower LDO with very low quiescent current (90 μA typical at 1-mA load) and very low dropout voltage (typically 60 mV at light loads and 470 mV at 250-mA load current).

The quiescent current increases only slightly at dropout (120 μA typical), which prolongs battery life.

The LP2954 with a fixed 5-V output is available in three-pin TO-220 and DDPK/TO-263 packages. The adjustable LP2954 is provided in an 8-pin, small-outline SOIC package. The adjustable version also provides a resistor network which can be pin strapped to set the output to any voltage from to 1.23 V to 29 V.

Reverse battery protection is provided for the IN pin.

The tight line and load regulation (0.04% typical), as well as very low output temperature coefficient make the LP2954 well suited for use as a low-power voltage reference.

Output accuracy is ensured at both room temperature and over the entire operating temperature range.

Device Information⁽¹⁾

PART NUMBER	PACKAGE	BODY SIZE (NOM)
LP2954	SOIC (8)	4.90 mm x 3.91 mm
	DDPAK/TO-263 (3)	10.18 mm x 8.41 mm
	TO-220 (3)	14.986 mm x 10.16 mm

(1) For all available packages, see the orderable addendum at the end of the data sheet.

Simplified Schematic

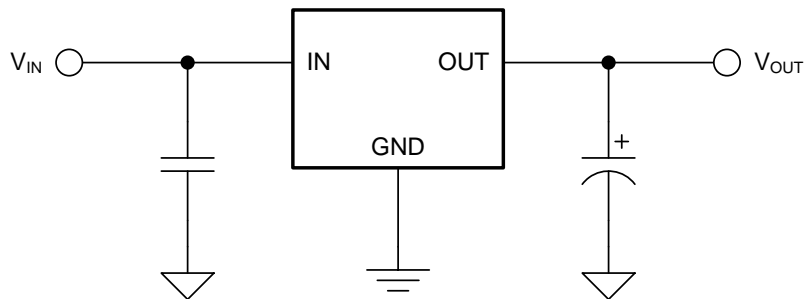

Table of Contents

1	Features	1	8	Application and Implementation	13
2	Applications	1	8.1	Application Information.....	13
3	Description	1	8.2	Typical Application	13
4	Revision History	2	9	Power Supply Recommendations	17
5	Pin Configuration and Functions	3	10	Layout	18
6	Specifications	4	10.1	Layout Guidelines	18
6.1	Absolute Maximum Ratings	4	10.2	Layout Example	18
6.2	ESD Ratings.....	4	11	Device and Documentation Support	19
6.3	Recommended Operating Conditions.....	4	11.1	Related Documentation	19
6.4	Thermal Information	4	11.2	Related Links	19
6.5	Electrical Characteristics.....	5	11.3	Receiving Notification of Documentation Updates	19
6.6	Typical Characteristics	7	11.4	Community Resources.....	19
7	Detailed Description	10	11.5	Trademarks	19
7.1	Overview	10	11.6	Electrostatic Discharge Caution.....	19
7.2	Functional Block Diagrams	10	11.7	Glossary	19
7.3	Feature Description.....	11	12	Mechanical, Packaging, and Orderable	
7.4	Device Functional Modes.....	12		Information	20

4 Revision History

NOTE: Page numbers for previous revisions may differ from page numbers in the current version.

Changes from Revision D (March 2013) to Revision E	Page
• Changed "voltage regulator" to "LDO".....	1
• Added <i>Device Information</i> and <i>Pin Configuration and Functions</i> sections, <i>ESD Ratings</i> and <i>Thermal Information</i> tables, <i>Feature Description</i> , <i>Device Functional Modes</i> , <i>Application and Implementation</i> , <i>Power Supply Recommendations</i> , <i>Layout</i> , <i>Device and Documentation Support</i> , and <i>Mechanical, Packaging, and Orderable Information</i> sections; added top nav icon for TI Designs	1
• Changed $R_{\theta JA}$ value for DDPAK/TO-263 from "73°C/W" to "44.3°C/W"; TO-220 from "60°C/W" to "80.3°C/W"; SOIC from "160°C/W" to "105.0°C/W". These values were in former FN 3 to <i>Abs Max</i> table.....	4
• Added <i>Power Dissipation</i>	15
• Added <i>Estimating Junction Temperature</i>	15

Changes from Revision C (March 2013) to Revision D	Page
• Changed layout of National Semiconductor data sheet to TI format.....	18

5 Pin Configuration and Functions

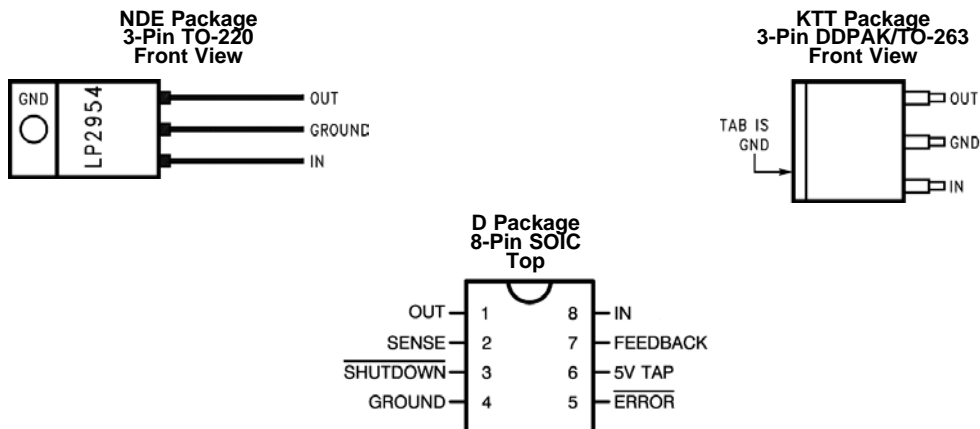

Pin Functions

NAME	PIN			I/O	DESCRIPTION
	NDE	KTT	D		
ERROR	—	—	5	O	Error output
FEEDBACK	—	—	7	I	Voltage feedback input
IN	1	1	8	I	Unregulated input voltage
GND	2	2	4	—	Ground
OUT	3	3	1	O	Regulated output voltage. This pin requires an output capacitor to maintain stability. See Detailed Design Procedure for output capacitor details
SENSE	—	—	2	I	Output voltage sense
SHUTDOWN	—	—	3	I	Disable device
5V TAP	—	—	6	O	Internal resistor divider

6 Specifications

6.1 Absolute Maximum Ratings

over operating free-air temperature range (unless otherwise noted)⁽¹⁾⁽²⁾

	MIN	MAX	UNIT
Input supply voltage	–20	30	V
Power dissipation ⁽¹⁾	Internally Limited		
Storage temperature, T_{stg}	–65	150	°C

- (1) At elevated temperatures, device power dissipation must be derated based on package thermal resistance and heat sink values (if a heat sink is used). If power dissipation causes the junction temperature to exceed specified limits, the device goes into thermal shutdown.
- (2) If Military/Aerospace specified devices are required, please contact the Texas Instruments Sales Office/Distributors for availability and specifications.

6.2 ESD Ratings

	VALUE	UNIT
$V_{(ESD)}$ Electrostatic discharge Human-body model (HBM), per ANSI/ESDA/JEDEC JS-001 ⁽¹⁾	±2000	V

- (1) JEDEC document JEP155 states that 500-V HBM allows safe manufacturing with a standard ESD control process.

6.3 Recommended Operating Conditions

over operating free-air temperature range (unless otherwise noted)

	MIN	NOM	MAX	UNIT
Operating junction temperature	–40		125	°C

6.4 Thermal Information

THERMAL METRIC ⁽¹⁾	LP2954, LP2954A			UNIT
	KTT (DDPAK/TO-263)	NDE (TO-220)	D (SOIC)	
	3 PINS	3 PINS	8 PINS	
$R_{\theta JA}$ ⁽²⁾ Junction-to-ambient thermal resistance, High-K	44.3	80.3 ⁽³⁾	105.0	°C/W
$R_{\theta JC(top)}$ Junction-to-case (top) thermal resistance	44.8	38.6	47.3	°C/W
$R_{\theta JB}$ Junction-to-board thermal resistance	23.8	73.1	45.8	°C/W
ψ_{JT} Junction-to-top characterization parameter	10.6	13.5	6.2	°C/W
ψ_{JB} Junction-to-board characterization parameter	22.7	73.1	45.2	°C/W
$R_{\theta JC(bot)}$ Junction-to-case (bottom) thermal resistance	1.0	0.9	—	°C/W

- (1) For more information about traditional and new thermal metrics, see [Semiconductor and IC Package Thermal Metrics](#).
- (2) Thermal resistance value $R_{\theta JA}$ is based on the EIA/JEDEC High-K printed circuit board defined by *JESD51-7 - High Effective Thermal Conductivity Test Board for Leaded Surface Mount Packages*.
- (3) The TO-220 (NDE) package is vertically mounted in center of JEDEC High-K test board (JESD 51-7) with no additional heat sink. This is a through-hole package; this is NOT a surface mount package.

6.5 Electrical Characteristics

Limits are specified by production testing or correlation techniques using standard Statistical Quality Control (SQC) methods. Unless otherwise noted: $T_J = 25^\circ\text{C}$, $V_{IN} = 6\text{ V}$, $I_L = 1\text{ mA}$, $C_L = 2.2\text{ }\mu\text{F}$

PARAMETER		TEST CONDITIONS	LP2954AI			LP2954I			UNIT
			MIN	TYP	MAX	MIN	TYP	MAX	
V_O	Output voltage ⁽¹⁾		4.975	5	5.025	4.95	5	5.05	V
		-40°C to 125°C	4.94		5.06	4.9		5.1	
		$1\text{ mA} \leq I_L \leq 250\text{ mA}$		5			5		
		$1\text{ mA} \leq I_L \leq 250\text{ mA}$ -40°C to 125°C	4.93		5.07	4.88		5.12	
$\Delta V_O/\Delta T$	Output voltage temperature coefficient	See ⁽²⁾ , $-40^\circ\text{C} \leq T_J \leq 125^\circ\text{C}$		20	100		20	150	ppm/ $^\circ\text{C}$
$\Delta V_O/V_O$	Line regulation	$V_{IN} = 6\text{ V}$ to 30 V		0.03%	0.1%		0.03%	0.2%	
		$V_{IN} = 6\text{ V}$ to 30 V $-40^\circ\text{C} \leq T_J \leq 125^\circ\text{C}$			0.2%			0.3%	
$\Delta V_O/V_O$	Load regulation	$I_L = 1$ to 250 mA $I_L = 0.1$ to 1 mA ⁽³⁾		0.04%	0.16%		0.04%	0.2%	
		$I_L = 1$ to 250 mA $I_L = 0.1$ to 1 mA $-40^\circ\text{C} \leq T_J \leq 125^\circ\text{C}$			0.2%			0.3%	
$V_{IN} - V_O$	Dropout voltage ⁽⁴⁾	$I_L = 1\text{ mA}$		60	100		60	100	mV
		$I_L = 1\text{ mA}$ $-40^\circ\text{C} \leq T_J \leq 125^\circ\text{C}$			150			150	
		$I_L = 50\text{ mA}$		240	300		240	300	
		$I_L = 50\text{ mA}$, $-40^\circ\text{C} \leq T_J \leq 125^\circ\text{C}$			420			420	
		$I_L = 100\text{ mA}$		310	400		310	400	
		$I_L = 100\text{ mA}$ $-40^\circ\text{C} \leq T_J \leq 125^\circ\text{C}$			520			520	
		$I_L = 250\text{ mA}$		470	600		470	600	
		$I_L = 250\text{ mA}$ $-40^\circ\text{C} \leq T_J \leq 125^\circ\text{C}$			800			800	
I_{GND}	Ground pin current ⁽⁵⁾	$I_L = 1\text{ mA}$		90	150		90	150	μA
		$I_L = 1\text{ mA}$ $-40^\circ\text{C} \leq T_J \leq 125^\circ\text{C}$			180			180	
		$I_L = 50\text{ mA}$		1.1	2		1.1	2	mA
		$I_L = 50\text{ mA}$ $-40^\circ\text{C} \leq T_J \leq 125^\circ\text{C}$			2.5			2.5	
		$I_L = 100\text{ mA}$		4.5	6		4.5	6	
		$I_L = 100\text{ mA}$ $-40^\circ\text{C} \leq T_J \leq 125^\circ\text{C}$			8			8	
		$I_L = 250\text{ mA}$		21	28		21	28	
		$I_L = 250\text{ mA}$ $-40^\circ\text{C} \leq T_J \leq 125^\circ\text{C}$			33			33	
I_{GND}	Ground pin current at dropout ⁽⁵⁾	$V_{IN} = 4.5\text{ V}$		120	170		120	170	μA
		$V_{IN} = 4.5\text{ V}$ $-40^\circ\text{C} \leq T_J \leq 125^\circ\text{C}$			210			210	

- (1) When used in dual-supply systems where the regulator load is returned to a negative supply, the output voltage must be diode-clamped to ground.
- (2) Output voltage temperature coefficient is defined as the worst-case voltage change divided by the total temperature range.
- (3) Regulation is measured at constant junction temperature using low duty cycle pulse testing. Parts are tested separately for load regulation in the load ranges 0.1 mA to 1 mA and 1 mA to 250 mA. Changes in output voltage due to heating effects are covered by the thermal regulation specification.
- (4) Dropout voltage is defined as the input-to-output differential at which the output voltage drops 100 mV below the value measured with a 1-V differential.
- (5) GND pin current is the regulator quiescent current. The total current drawn from the source is the sum of the load current plus the GND pin current.

Electrical Characteristics (continued)

Limits are specified by production testing or correlation techniques using standard Statistical Quality Control (SQC) methods. Unless otherwise noted: $T_J = 25^\circ\text{C}$, $V_{IN} = 6\text{ V}$, $I_L = 1\text{ mA}$, $C_L = 2.2\text{ }\mu\text{F}$

PARAMETER	TEST CONDITIONS	LP2954AI			LP2954I			UNIT	
		MIN	TYP	MAX	MIN	TYP	MAX		
I_{LIMIT}	Current limit	$V_O = 0\text{ V}$	380	500		380	500	mA	
		$V_O = 0\text{ V}$ $-40^\circ\text{C} \leq T_J \leq 125^\circ\text{C}$			530		530		
$\Delta V_O / \Delta P_D$	Thermal regulation	See ⁽⁶⁾	0.05	0.2		0.05	0.2	%/W	
e_n	Output noise 10 Hz to 100 kHz	$I_L = 100\text{ mA}$, $C_L = 2.2\text{ }\mu\text{F}$	400			400		μV_{RMS}	
		$I_L = 100\text{ mA}$, $C_L = 33\text{ }\mu\text{F}$	260			260			
		$I_L = 100\text{ mA}$, $C_L = 33\text{ }\mu\text{F}$ ⁽⁷⁾	80			80			
ADDITIONAL SPECIFICATIONS FOR THE ADJUSTABLE DEVICE (LP2954AIM and LP2954IM)									
V_{REF}	Reference voltage	See ⁽⁸⁾	1.215	1.23	1.245	1.205	1.23	1.255	V
		See ⁽⁸⁾ $-40^\circ\text{C} \leq T_J \leq 125^\circ\text{C}$	1.205		1.255	1.19		1.27	
$\Delta V_{REF} / V_{REF}$	Reference voltage line regulation	$V_{IN} = 2.5\text{ V to } V_{O(NOM)} + 1\text{ V}$		0.03%	0.1%		0.03%	0.2%	
		$V_{IN} = 2.5\text{ V to } V_{O(NOM)} + 1\text{ V to } 30\text{ V}$ ⁽⁹⁾⁽⁸⁾ $-40^\circ\text{C} \leq T_J \leq 125^\circ\text{C}$			0.2%			0.4%	
$\Delta V_{REF} / \Delta T$	Reference voltage temperature coefficient	See ⁽²⁾ $-40^\circ\text{C} \leq T_J \leq 125^\circ\text{C}$		20				ppm/ $^\circ\text{C}$	
$I_{B(FB)}$	Feedback pin bias current		20	40		20	40	nA	
		$-40^\circ\text{C} \leq T_J \leq 125^\circ\text{C}$			60		60		
I_{GND}	Ground pin current at shutdown ⁽⁵⁾	$V_{SHUTDOWN} \leq 1.1\text{ V}$	105	140		105	140	μA	
$I_{O(SINK)}$	Output OFF pulldown current	See ⁽¹⁰⁾	30			30		mA	
		See ⁽¹⁰⁾ $-40^\circ\text{C} \leq T_J \leq 125^\circ\text{C}$	20			20			
DROPOUT DETECTION COMPARATOR									
I_{OH}	Output HIGH leakage current	$V_{OH} = 30\text{ V}$		0.01	1		0.01	1	μA
		$V_{OH} = 30\text{ V}$, $-40^\circ\text{C} \leq T_J \leq 125^\circ\text{C}$				2		2	
V_{OL}	Output LOW voltage	$V_{IN} = V_{O(NOM)} - 0.5\text{ V}$ $I_{O(OMP)} = 400\text{ }\mu\text{A}$ $-40^\circ\text{C} \leq T_J \leq 125^\circ\text{C}$	150	250		150	250	mV	
					400		400		
$V_{THR(MAX)}$	Upper threshold voltage	See ⁽¹¹⁾	-80	-60	-35	-80	-60	-35	mV
		See ⁽¹¹⁾ $-40^\circ\text{C} \leq T_J \leq 125^\circ\text{C}$	-95		-25	-95		-25	
$V_{THR(MIN)}$	Lower threshold voltage	See ⁽¹¹⁾	-110	-85	-55	-110	-85	-55	mV
		See ⁽¹¹⁾ $-40^\circ\text{C} \leq T_J \leq 125^\circ\text{C}$	-160		-40	-160		-40	
HYST	Hysteresis	See ⁽¹¹⁾		15			15	mV	

- (6) Thermal regulation is defined as the change in output voltage at a time T after a change in power dissipation is applied, excluding load or line regulation effects. Specifications are for 200-mA load pulse at $V_{IN} = 20\text{ V}$ (3-W pulse) for $T = 10\text{ ms}$.
- (7) Connect a 0.1- μF capacitor from the OUT pin to the FEEDBACK pin.
- (8) $V_{REF} \leq V_{OUT} \leq (V_{IN} - 1\text{ V})$, $2.3\text{ V} \leq V_{IN} \leq 30\text{ V}$, $100\text{ }\mu\text{A} \leq I_L \leq 250\text{ mA}$.
- (9) Two separate tests are performed, one covering $V_{IN} = 2.5\text{ V to } V_{O(NOM)} + 1\text{ V}$ and the other test for $V_{IN} = 2.5\text{ V to } V_{O(NOM)} + 1\text{ V to } 30\text{ V}$.
- (10) $V_{SHUTDOWN} \leq 1.1\text{ V}$, $V_{OUT} = V_{O(NOM)}$.
- (11) Comparator thresholds are expressed in terms of a voltage differential at the FEEDBACK pin below the nominal reference voltage measured at $V_{IN} = V_{O(NOM)} + 1\text{ V}$. To express these thresholds in terms of output voltage change, multiply by the error amplifier gain, which is $V_{OUT} / V_{REF} = (R1 + R2) / R2$.

Electrical Characteristics (continued)

Limits are specified by production testing or correlation techniques using standard Statistical Quality Control (SQC) methods. Unless otherwise noted: $T_J = 25^\circ\text{C}$, $V_{IN} = 6\text{ V}$, $I_L = 1\text{ mA}$, $C_L = 2.2\text{ }\mu\text{F}$

PARAMETER	TEST CONDITIONS	LP2954AI			LP2954I			UNIT
		MIN	TYP	MAX	MIN	TYP	MAX	
SHUTDOWN INPUT								
V_{OS} Input offset voltage	(Referred to V_{REF})	-7.5	± 3	7.5	-7.5	± 3	7.5	mV
	(Referred to V_{REF} , $-40^\circ\text{C} \leq T_J \leq 125^\circ\text{C}$)	-10		10	-10		10	
HYST	Hysteresis		6			6		mV
I_B Input bias current	$V_{IN(\text{SHUTDOWN})} = 0\text{ V to }5\text{ V}$	-30	10	30	-30	10	30	nA
	$V_{IN(\text{SHUTDOWN})} = 0\text{ V to }5\text{ V}, -40^\circ\text{C} \leq T_J \leq 125^\circ\text{C}$	-50		50	-50		50	

6.6 Typical Characteristics

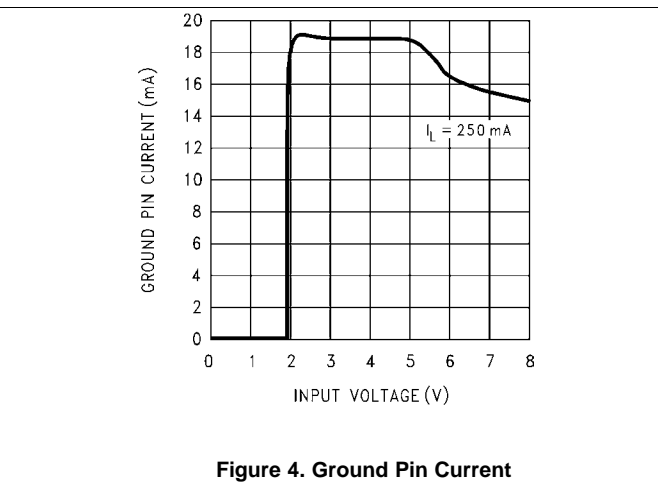
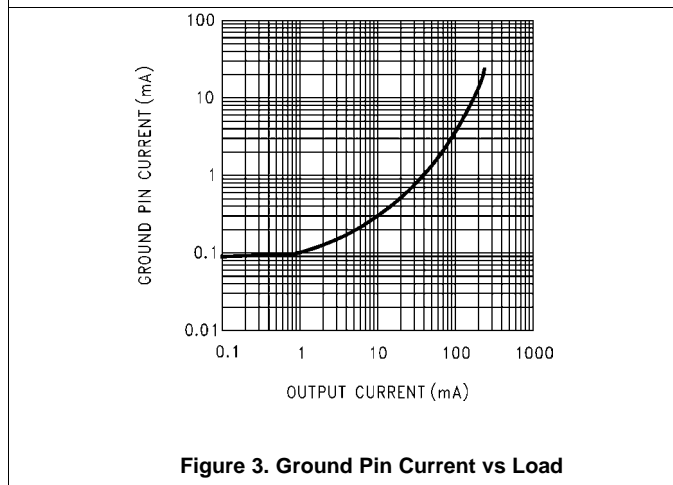
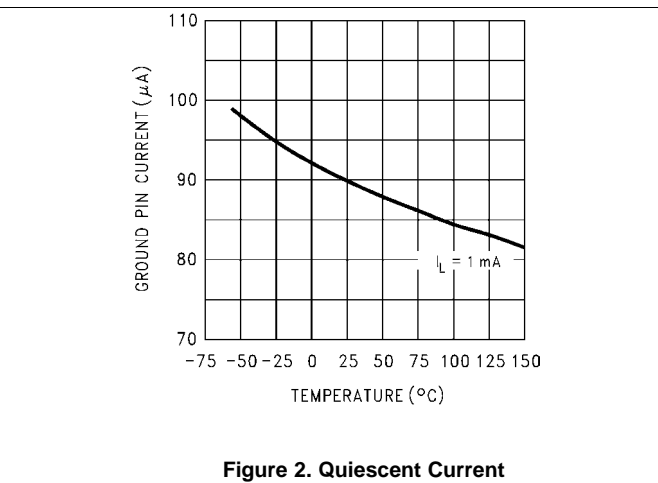
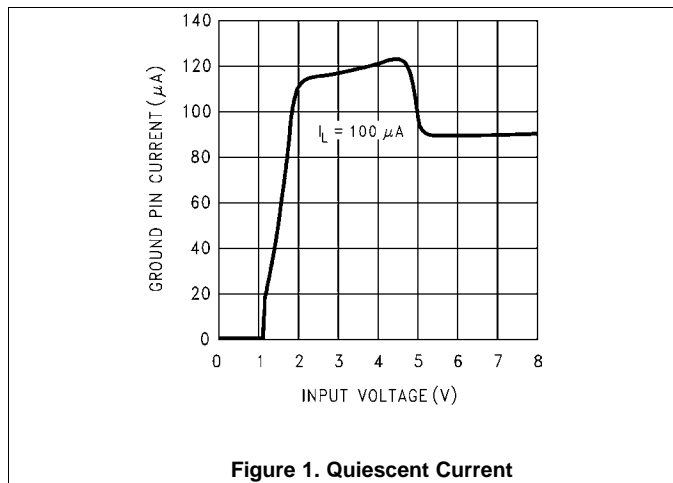

Typical Characteristics (continued)

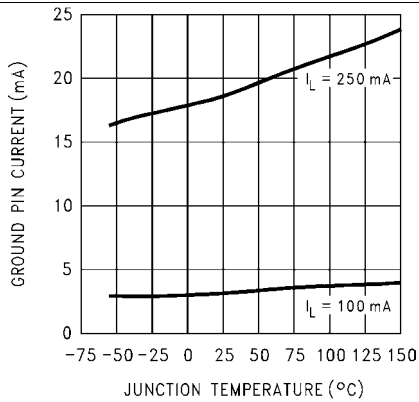

Figure 5. Ground Pin Current

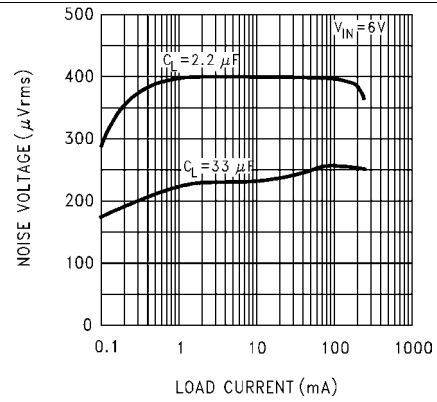

Figure 6. Output Noise Voltage

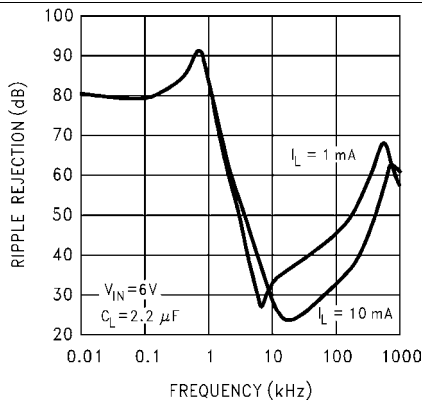

Figure 7. Ripple Rejection

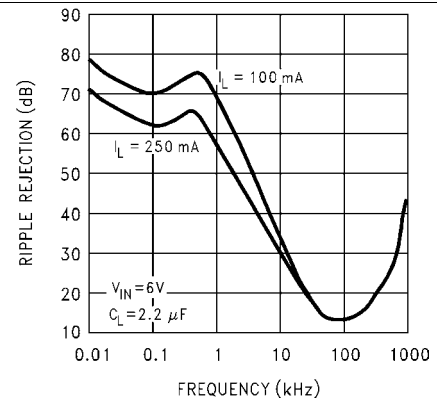

Figure 8. Ripple Rejection

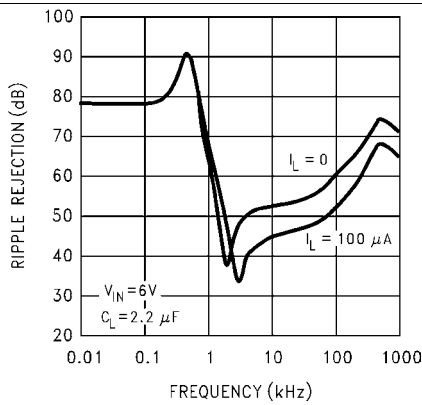

Figure 9. Ripple Rejection

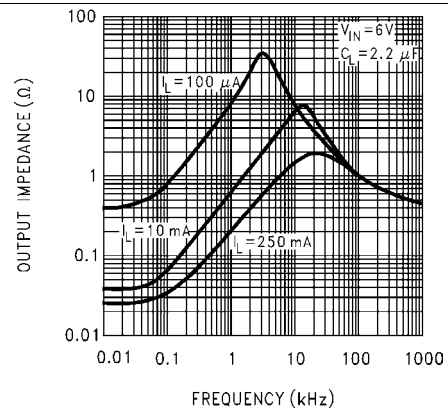

Figure 10. Output Impedance

Typical Characteristics (continued)

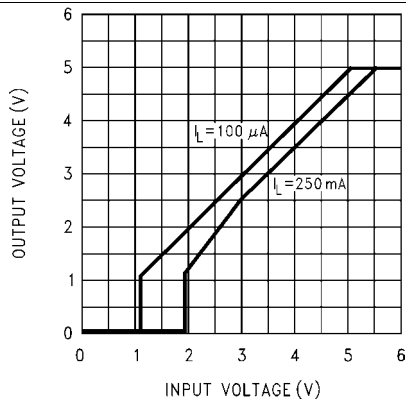

Figure 11. Dropout Characteristics

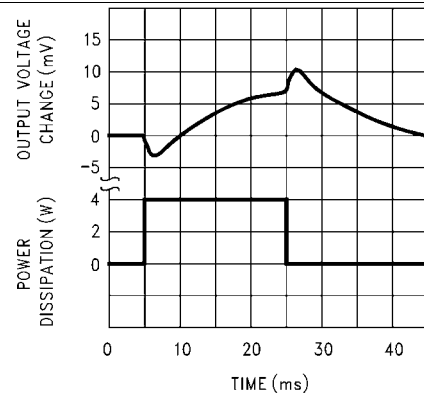

Figure 12. Thermal Response

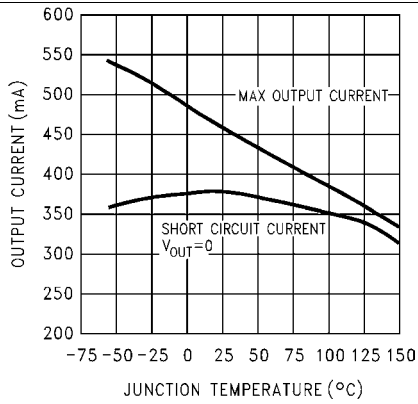

Figure 13. Short-Circuit Output Current and Maximum Output Current

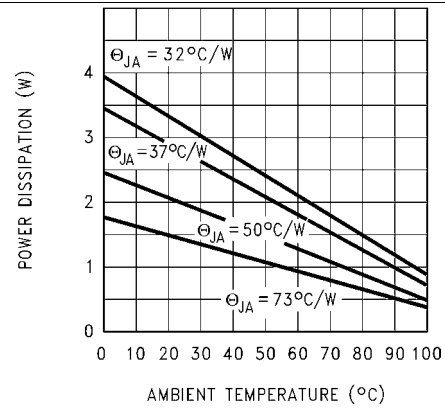

Figure 14. Maximum Power Dissipation (DDPAK/TO-263)

7 Detailed Description

7.1 Overview

The LP2954 is a 5-V micropower LDO with very low quiescent current (90 μ A typical at 1-mA load) and very low dropout voltage (typically 60 mV at light loads and 470 mV at 250-mA load current).

7.2 Functional Block Diagrams

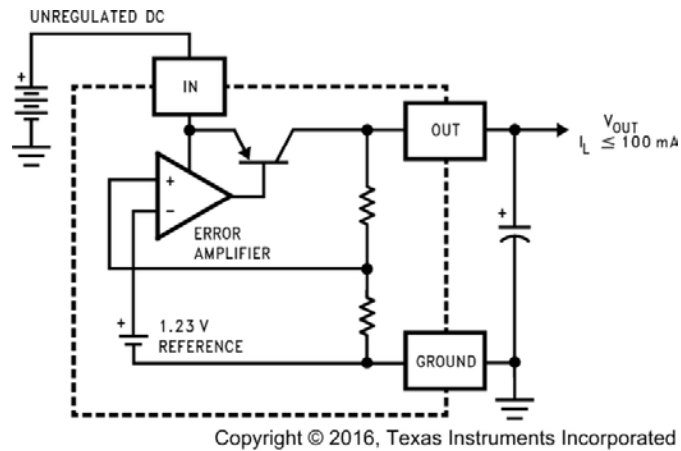

Figure 15. LP2954 TO-220 and TO-263 Functional Block Diagram

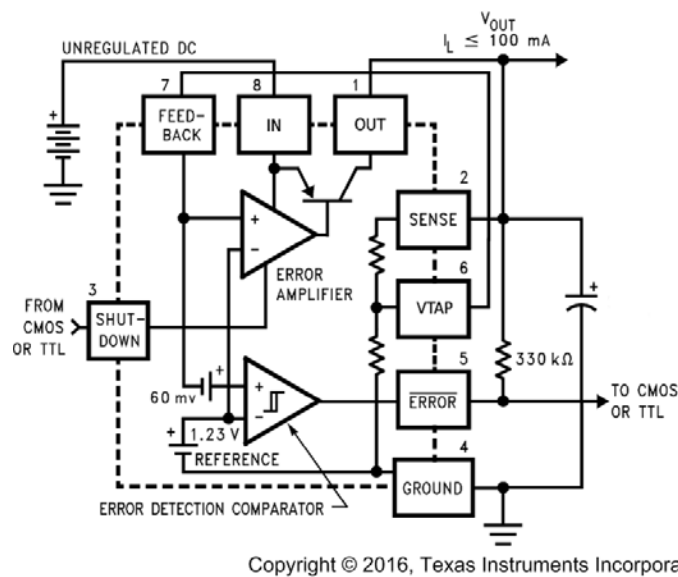

Figure 16. LP2954 SOIC Functional Block Diagram

7.3 Feature Description

7.3.1 Dropout Voltage

The dropout voltage of the regulator is defined as the minimum input-to-output voltage differential required for the output voltage to stay within 100 mV of the output voltage measured with a 1-V differential. The dropout voltages for various values of load current are listed under [Electrical Characteristics](#).

If the regulator is powered from a rectified AC source with a capacitive filter, the minimum AC line voltage and maximum load current must be used to calculate the minimum voltage at the input of the regulator. The minimum input voltage, *including AC ripple on the filter capacitor*, must not drop below the voltage required to keep the LP2954 in regulation. It is also advisable to verify operating at *minimum* operating ambient temperature, because the increasing ESR of the filter capacitor makes this a worst-case test for dropout voltage due to increased ripple amplitude.

7.3.2 Dropout Detection Comparator

This comparator produces a logic LOW whenever the output falls out of regulation by more than about 5%. The 5% value is from the comparators built-in offset of 60 mV divided by the 1.23-V reference. The 5% low trip level remains constant regardless of the programmed output voltage. An out-of-regulation condition can result from low input voltage, current limiting, or thermal limiting.

[Figure 17](#) gives a timing diagram showing the relationship between the output voltage, the $\overline{\text{ERROR}}$ output, and input voltage as the input voltage is ramped up and down to a regulator programmed for 5-V output. The $\overline{\text{ERROR}}$ signal becomes low at about 1.3-V input. It goes high at about 5-V input, where the output equals 4.75 V. Because the dropout voltage is load dependent, the *input* voltage trip points vary with load current. The *output* voltage trip point does not vary.

The comparator has an open-collector output which requires an external pullup resistor. This resistor may be connected to the regulator output or some other supply voltage. Using the regulator output prevents an invalid HIGH on the comparator output which occurs if it is pulled up to an external voltage while the regulator input voltage is reduced below 1.3 V. In selecting a value for the pullup resistor note that, while the output can sink 400 μA , this current adds to battery drain. Suggested values range from 100 k Ω to 1 M Ω . This resistor is not required if the output is unused.

When $V_{\text{IN}} \leq 1.3 \text{ V}$, the $\overline{\text{ERROR}}$ pin becomes a high impedance, allowing the error flag voltage to rise to its pullup voltage. Using V_{OUT} as the pullup voltage (rather than an external 5-V source) keeps the error flag voltage below 1.2 V (typical) in this condition. The user may wish to divide down the error flag voltage using equal-value resistors (10 k Ω suggested) to ensure a low-level logic signal during any fault condition, while still allowing a valid high logic level during normal operation.

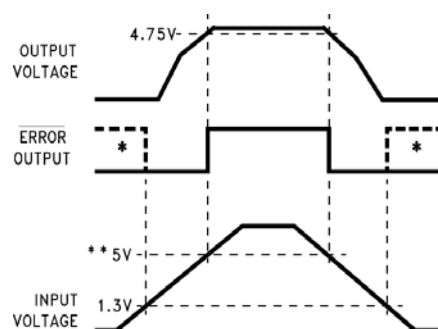

* In shutdown mode, $\overline{\text{ERROR}}$ goes high if it has been pulled up to an external supply. To avoid this invalid response, pull up to regulator output.

** Exact value depends on dropout voltage. (See [Dropout Voltage](#))

Figure 17. $\overline{\text{ERROR}}$ Output Timing

7.3.3 Output Isolation

The regulator output can be left connected to an active voltage source (such as a battery) with the regulator input power turned off, *as long as the regulator ground pin is connected to ground*. If the ground pin is left floating, *damage to the regulator can occur* if the output is pulled up by an external voltage source.

Feature Description (continued)

7.3.4 Reducing Output Noise

In reference applications it may be advantageous to reduce the AC noise present on the output. One method is to reduce regulator bandwidth by increasing output capacitance. This is relatively inefficient, because large increases in capacitance are required to get significant improvement.

Noise can be reduced more effectively by a bypass capacitor placed across R1 (refer to [Figure 19](#)). The formula for selecting the capacitor to be used is:

$$C_B = 1 / 2\pi R1 \times 20 \text{ Hz} \quad (1)$$

This gives a value of about 0.1 μF . When this is used, the output capacitor must be 6.8 μF (or greater) to maintain stability. The 0.1- μF capacitor reduces the high frequency gain of the circuit to unity, lowering the output noise from 260 μV to 80 μV using a 10-Hz to 100-kHz bandwidth. Also, noise is no longer proportional to the output voltage, so improvements are more pronounced at high output voltages.

7.4 Device Functional Modes

7.4.1 Shutdown Input

A logic-level signal shuts off the regulator output when a LOW (< 1.2 V) is applied to the $\overline{\text{SHUTDOWN}}$ input.

To prevent possible mis-operation, the $\overline{\text{SHUTDOWN}}$ input must be actively terminated. If the input is driven from open-collector logic, a pullup resistor (TI recommends 20 k Ω to 100 k Ω) must be connected from the $\overline{\text{SHUTDOWN}}$ input to the regulator input.

If the $\overline{\text{SHUTDOWN}}$ input is driven from a source that actively pulls high and low (like an operational amplifier), the pullup resistor is not required, but may be used.

If the shutdown function is not to be used, the cost of the pullup resistor can be saved by simply tying the $\overline{\text{SHUTDOWN}}$ input directly to the regulator input.

IMPORTANT: Because the [Absolute Maximum Ratings](#) state that the $\overline{\text{SHUTDOWN}}$ input cannot go more than 0.3 V below ground, the reverse-battery protection feature that protects the regulator input is sacrificed if the $\overline{\text{SHUTDOWN}}$ input is tied directly to the regulator input.

If reverse-battery protection is required in an application, the pullup resistor between the $\overline{\text{SHUTDOWN}}$ input and the regulator input must be used. The recommended 20 k Ω to 100 k Ω provides adequate protection of the $\overline{\text{SHUTDOWN}}$ pin during negative voltage transitions at the IN pin.

8 Application and Implementation

NOTE

Information in the following applications sections is not part of the TI component specification, and TI does not warrant its accuracy or completeness. TI's customers are responsible for determining suitability of components for their purposes. Customers should validate and test their design implementation to confirm system functionality.

8.1 Application Information

The LP2954-N is a linear voltage regulator operating from 2.3 V to 30 V on the input and regulated output voltage of 5 V with typical 0.5% accuracy (LP2954AI) and 250 mA maximum output current. For linear voltage regulator the efficiency is defined by the ratio of output voltage to input voltage (efficiency = V_{OUT}/V_{IN}). To achieve high efficiency, the dropout voltage ($V_{IN} - V_{OUT}$) must be as small as possible, thus requiring a very low dropout LDO. Successfully implementing an LDO in an application depends on the application requirements. If the requirements are simply input voltage and output voltage, compliance specifications (such as internal power dissipation or stability) must be verified to ensure a solid design. If timing, start-up, noise, PSRR, or any other transient specification is required, the design becomes more challenging.

8.2 Typical Application

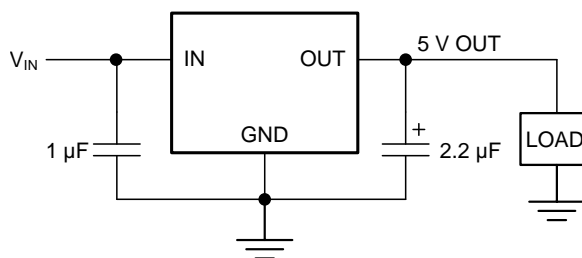

Figure 18. LP2954 Typical Application

8.2.1 Design Requirements

For typical LDO applications, use the parameters listed in [Table 1](#).

Table 1. Design Parameters

DESIGN PARAMETER	EXAMPLE VALUE
Input voltage	2.5 V to 30 V
Output voltage	1.23 V to 29 V
Output current	250 mA (maximum)
RMS noise, 10 Hz to 100 kHz	260 μ V _{RMS}

8.2.2 Detailed Design Procedure

8.2.2.1 External Capacitors

A 2.2 μ F (or greater) capacitor is *required* between the OUT pin and GND to assure stability (refer to [Figure 20](#)). Without this capacitor, the device may oscillate. Most types of tantalum or aluminum electrolytic capacitors work here. Film-type capacitors work, but are more expensive. Many aluminum electrolytics contain electrolytes which freeze at -30°C , which requires the use of solid tantalums below -25°C . The important parameters of the capacitor are an equivalent series resistance (ESR) of about 5 Ω or less and a resonant frequency above 500 kHz (the ESR may increase by a factor of 20 or 30 as the temperature is reduced from 25°C to -30°C). The value of this capacitor may be increased without limit. At lower values of output current, less output capacitance is required for stability. The capacitor can be reduced to 0.68 μ F for currents below 10 mA or 0.22 μ F for currents below 1 mA.

Place a 1- μ F capacitor from the IN pin to GND if there is more than 10 inches of wire between the input and the AC filter capacitor or if a battery input is used.

Programming the output for voltages below 5 V runs the error amplifier at lower gains requiring more output capacitance for stability. At 3.3-V output, a minimum of 4.7 μ F is required. For the worst case condition of 1.23-V output and 250 mA of load current, a 6.8- μ F (or larger) capacitor must be used.

Stray capacitance to the FEEDBACK pin can cause instability. This problem is most likely to appear when using high value external resistors to set the output voltage. Adding a 100-pF capacitor between the OUT and FEEDBACK pins and increasing the output capacitance to 6.8 μ F (or greater) solves the problem.

8.2.2.2 Minimum Load

When setting the output voltage using an external resistive divider, TI recommends a minimum current of 1 μ A through the resistors to provide a minimum load.

It should be noted that a minimum load current is specified in several of the electrical characteristic test conditions, so this value must be used to obtain correlation on these tested limits. The part is parametrically tested down to 100 μ A, but is functional with no load.

8.2.2.3 Programming The Output Voltage

The SOIC version of the LP2954 regulator may be pin strapped for 5-V operation using its internal resistive divider by tying the OUT and SENSE pins together and also tying the FEEDBACK and 5V TAP pins together.

Alternatively, it may be programmed for any voltage between the 1.23-V reference and the 30-V maximum rating using an external pair of resistors (see [Figure 19](#)). The complete equation for the output voltage is:

$$V_{OUT} = V_{REF} \times (1 + R1 / R2) + (I_{FB} \times R1) \quad (2)$$

where V_{REF} is the 1.23-V reference and I_{FB} is the FEEDBACK pin bias current (-20 nA typical). The minimum recommended load current of 1 μ A sets an upper limit of 1.2 M Ω on the value of R2 in cases where the regulator must work with no load (see [Minimum Load](#)). I_{FB} produces a typical 2% error in V_{OUT} which can be eliminated at room temperature by trimming R1. For better accuracy, choosing R2 = 100 k Ω reduces this error to 0.17% while increasing the resistor program current to 12 μ A. Because the typical quiescent current is 120 μ A, this added current is negligible.

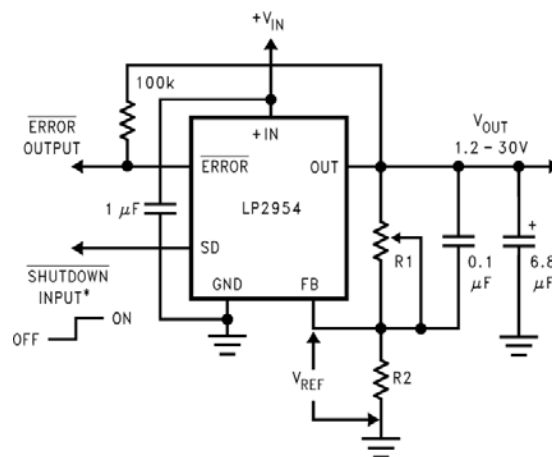

Copyright © 2016, Texas Instruments Incorporated

*Drive with TTL-low to shutdown

Figure 19. Adjustable Regulator

8.2.2.4 Power Dissipation

Knowing the device power dissipation and proper sizing of the thermal plane connected to the tab or pad is critical to ensuring reliable operation. Device power dissipation depends on input voltage, output voltage, and load conditions and can be calculated with [Equation 3](#).

$$P_{D(MAX)} = (V_{IN(MAX)} - V_{OUT}) \times I_{OUT} \quad (3)$$

Power dissipation can be minimized, and greater efficiency can be achieved, by using the lowest available voltage drop option that would still be greater than the dropout voltage (V_{DO}). However, keep in mind that higher voltage drops result in better dynamic (that is, PSRR and transient) performance.

Power dissipation and junction temperature are most often related by the junction-to-ambient thermal resistance ($R_{\theta JA}$) of the combined PCB and device package and the temperature of the ambient air (T_A), according to [Equation 4](#) or [Equation 5](#):

$$T_{J(MAX)} = T_{A(MAX)} + (R_{\theta JA} \times P_{D(MAX)}) \quad (4)$$

$$P_{D(MAX)} = (T_{J(MAX)} - T_{A(MAX)}) / R_{\theta JA} \quad (5)$$

Unfortunately, this $R_{\theta JA}$ is highly dependent on the heat-spreading capability of the particular PCB design, and therefore varies according to the total copper area, copper weight, and location of the planes. The $R_{\theta JA}$ recorded in [Thermal Information](#) is determined by the specific EIA/JEDEC JESD51-7 standard for PCB and copper-spreading area, and is to be used only as a relative measure of package thermal performance. For a well-designed thermal layout, $R_{\theta JA}$ is actually the sum of the package junction-to-case (bottom) thermal resistance ($R_{\theta JCbot}$) plus the thermal resistance contribution by the PCB copper area acting as a heat sink.

8.2.2.5 Estimating Junction Temperature

The EIA/JEDEC standard recommends the use of psi (Ψ) thermal characteristics to estimate the junction temperatures of surface mount devices on a typical PCB board application. These characteristics are not true thermal resistance values, but rather package specific thermal characteristics that offer practical and relative means of estimating junction temperatures. These psi metrics are determined to be significantly independent of copper-spreading area. The key thermal characteristics (Ψ_{JT} and Ψ_{JB}) are given in [Thermal Information](#) and are used in accordance with [Equation 6](#) or [Equation 7](#).

$$T_{J(MAX)} = T_{TOP} + (\Psi_{JT} \times P_{D(MAX)})$$

where

- $P_{D(MAX)}$ is explained in [Equation 5](#)
- T_{TOP} is the temperature measured at the center-top of the device package. (6)

$$T_{J(MAX)} = T_{BOARD} + (\Psi_{JB} \times P_{D(MAX)})$$

where

- $P_{D(MAX)}$ is explained in [Equation 5](#).
- T_{BOARD} is the PCB surface temperature measured 1-mm from the device package and centered on the package edge. (7)

For more information about the thermal characteristics Ψ_{JT} and Ψ_{JB} , [Semiconductor and IC Package Thermal Metrics](#); for more information about measuring T_{TOP} and T_{BOARD} , see [Using New Thermal Metrics](#); and for more information about the EIA/JEDEC JESD51 PCB used for validating $R_{\theta JA}$, see [Thermal Characteristics of Linear and Logic Packages Using JEDEC PCB Designs](#). These application notes are available at www.ti.com.

8.2.2.6 Heatsinking the TO-220 Package

A heat sink may be required with the LP2954IT depending on the maximum power dissipation and maximum ambient temperature of the application. Under all possible operating conditions, the junction temperature must be within the range specified under [Recommended Operating Conditions](#).

To determine if a heat sink is required, the maximum power dissipated by the regulator, $P_{(MAX)}$, must be calculated. It is important to remember that if the regulator is powered from a transformer connected to the AC line, the *maximum specified AC input voltage* must be used (because this produces the maximum DC input voltage to the regulator). [Figure 20](#) shows the voltages and currents that are present in the circuit. The formula for calculating the power dissipated in the regulator is also shown in [Figure 20](#).

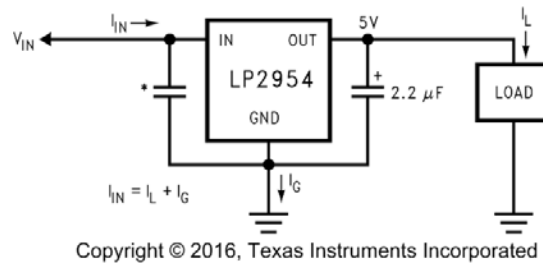

*See [External Capacitors](#)

$$P_D = ((V_{IN} - V_{OUT}) \times I_{OUT}) + (V_{IN} \times I_G)$$

Figure 20. Basic 5-V Regulator Circuit

The next parameter which must be calculated is the maximum allowable temperature rise, $T_{R(MAX)}$. This is calculated by using the formula:

$$T_{R(MAX)} = T_{J(MAX)} - T_{A(MAX)}$$

where

- $T_{J(MAX)}$ is the maximum allowable junction temperature
- $T_{A(MAX)}$ is the maximum ambient temperature

Using the calculated values for $T_{R(MAX)}$ and $P_{(MAX)}$, the required value for junction-to-ambient thermal resistance, $R_{\theta JA}$, can now be found:

$$R_{\theta JA} = T_{R(MAX)} / P_{(MAX)} \quad (9)$$

If the calculated value is 60°C/W or higher, the regulator may be operated without an external heat sink. If the calculated value is below 60°C/W , an external heatsink is required. The required thermal resistance for this heat sink can be calculated using the formula:

$$R_{\theta HA} = R_{\theta JA} - R_{\theta JC(bot)} - R_{\theta CH}$$

where

- $R_{\theta JC(bot)}$ is the junction-to-case thermal resistance, which is specified as 0.9°C/W maximum for the LP2954IT
- $R_{\theta CH}$ is the case-to-heat-sink thermal resistance, which is dependent on the interfacing material (if used). For details and typical values in [Table 2](#) and [Table 3](#).
- $R_{\theta(H-A)}$ is the heatsink-to-ambient thermal resistance. It is this specification (listed on the heat-sink manufacturers data sheet) which defines the effectiveness of the heat sink. The heat sink selected must have a thermal resistance which is equal to or lower than the value of $R_{\theta HA}$ calculated from the above listed formula.

Table 2. Typical Values of Case-To-Heatsink Thermal Resistance ($R_{\theta CH}$) (Data from Aavid Engineering)

	UNIT ($^\circ\text{C/W}$)
Silicone grease	1
Dry interface	1.3
Mica with grease	1.4

Table 3. Typical Values Of Case-To-Heatsink Thermal Resistance ($R_{\theta CH}$) (Data from Thermalloy)

	UNIT ($^\circ\text{C/W}$)
Thermasil III	1.3
Thermasil II	1.5
Thermalfilm (0.002) with grease	2.2

8.2.3 Application Curves

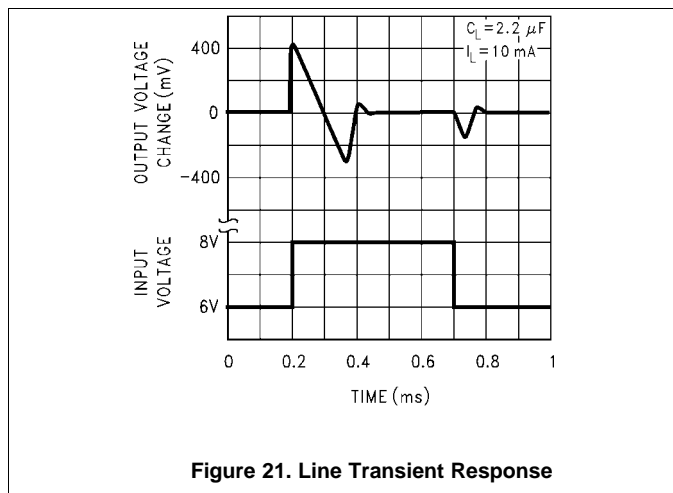

Figure 21. Line Transient Response

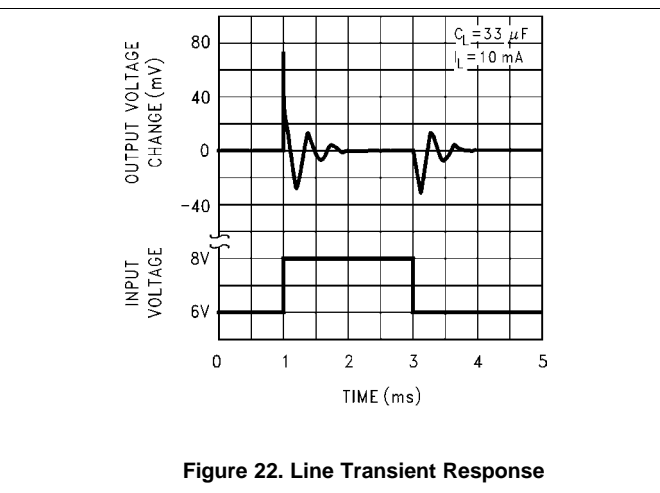

Figure 22. Line Transient Response

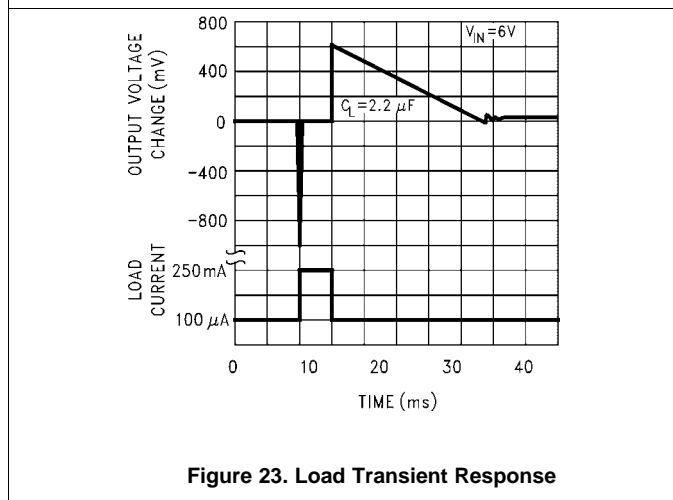

Figure 23. Load Transient Response

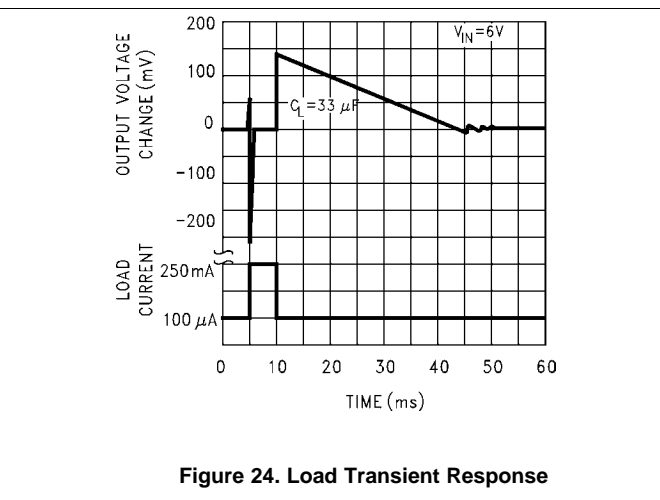

Figure 24. Load Transient Response

9 Power Supply Recommendations

The LP2954 is designed to operate from a minimum input voltage supply of either 2.5 V or $V_{OUT(NOM)} + 1$ V, whichever is higher. The maximum input supply voltage is 30 V, but may be limited by thermal dissipation of the selected package. The input voltage range provides adequate headroom in order for the device to have a regulated output. This input supply must be well regulated. If the input supply is noisy, additional input capacitors with low ESR can help improve the output noise performance.

10 Layout

10.1 Layout Guidelines

For best overall performance, place all the circuit components on the same side of the circuit board and as near as practical to the respective LDO pin connections. Place ground return connections to the input and output capacitor, and to the LDO ground pin as close as possible to each other, connected by a wide, component-side, copper surface. The use of vias and long traces to create LDO circuit connections is strongly discouraged and negatively affects system performance. This grounding and layout scheme minimizes inductive parasitic, and thereby reduces load-current transients, minimizes noise, and increases circuit stability.

TI also recommends a ground reference plane and is either embedded in the PCB itself or located on the bottom side of the PCB opposite the components. This reference plane serves to assure accuracy of the output voltage, shield noise, and behaves similar to a thermal plane to spread heat from the LDO device. In most applications, this ground plane is necessary to meet thermal requirements.

10.2 Layout Example

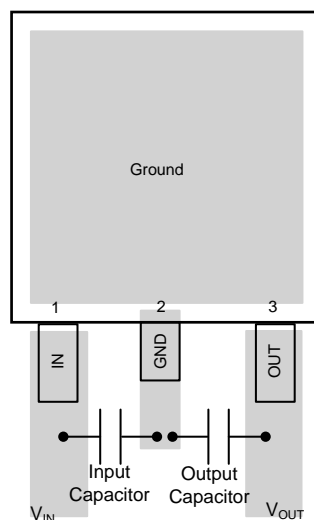

Figure 25. LP2954 TO-263 Board Layout

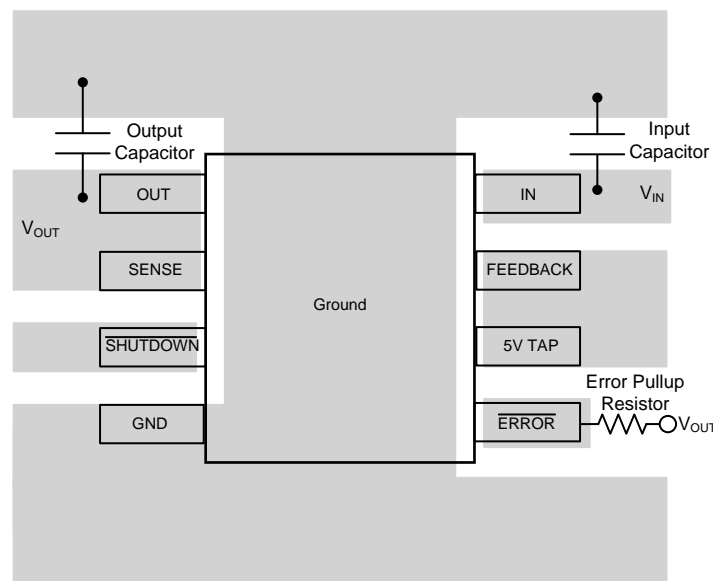

Figure 26. LP2954 SOIC Board Layout

11 Device and Documentation Support

11.1 Related Documentation

For additional information, see the following:

- [Semiconductor and IC Package Thermal Metrics](#)
- [Using New Thermal Metrics](#)
- [Thermal Characteristics of Linear and Logic Packages Using JEDEC PCB Designs](#)

11.2 Related Links

[Table 4](#) lists quick access links. Categories include technical documents, support and community resources, tools and software, and quick access to sample or buy.

Table 4. Related Links

PARTS	PRODUCT FOLDER	SAMPLE & BUY	TECHNICAL DOCUMENTS	TOOLS & SOFTWARE	SUPPORT & COMMUNITY
LP2954	Click here	Click here	Click here	Click here	Click here
LP2954A	Click here	Click here	Click here	Click here	Click here

11.3 Receiving Notification of Documentation Updates

To receive notification of documentation updates, navigate to the device product folder on ti.com. In the upper right corner, click on *Alert me* to register and receive a weekly digest of any product information that has changed. For change details, review the revision history included in any revised document.

11.4 Community Resources

The following links connect to TI community resources. Linked contents are provided "AS IS" by the respective contributors. They do not constitute TI specifications and do not necessarily reflect TI's views; see TI's [Terms of Use](#).

TI E2E™ Online Community *TI's Engineer-to-Engineer (E2E) Community*. Created to foster collaboration among engineers. At e2e.ti.com, you can ask questions, share knowledge, explore ideas and help solve problems with fellow engineers.

Design Support *TI's Design Support* Quickly find helpful E2E forums along with design support tools and contact information for technical support.

11.5 Trademarks

E2E is a trademark of Texas Instruments.
All other trademarks are the property of their respective owners.

11.6 Electrostatic Discharge Caution



These devices have limited built-in ESD protection. The leads should be shorted together or the device placed in conductive foam during storage or handling to prevent electrostatic damage to the MOS gates.

11.7 Glossary

[SLYZ022](#) — *TI Glossary*.

This glossary lists and explains terms, acronyms, and definitions.

12 Mechanical, Packaging, and Orderable Information

The following pages include mechanical, packaging, and orderable information. This information is the most current data available for the designated devices. This data is subject to change without notice and revision of this document. For browser-based versions of this data sheet, refer to the left-hand navigation.

PACKAGING INFORMATION

Orderable Device	Status (1)	Package Type	Package Drawing	Pins	Package Qty	Eco Plan (2)	Lead finish/ Ball material (6)	MSL Peak Temp (3)	Op Temp (°C)	Device Marking (4/5)	Samples
LP2954AIM	NRND	SOIC	D	8	95	Non-RoHS & Green	Call TI	Level-1-235C-UNLIM	-40 to 125	LP2954AIM	
LP2954AIM/NOPB	ACTIVE	SOIC	D	8	95	RoHS & Green	SN	Level-1-260C-UNLIM	-40 to 125	LP2954AIM	Samples
LP2954AIMX/NOPB	ACTIVE	SOIC	D	8	2500	RoHS & Green	SN	Level-1-260C-UNLIM	-40 to 125	LP2954AIM	Samples
LP2954AIS/NOPB	ACTIVE	DDPAK/ TO-263	KTT	3	45	RoHS-Exempt & Green	SN	Level-3-245C-168 HR	-40 to 125	LP2954AIS	Samples
LP2954AISX/NOPB	ACTIVE	DDPAK/ TO-263	KTT	3	500	RoHS-Exempt & Green	SN	Level-3-245C-168 HR	-40 to 125	LP2954AIS	Samples
LP2954AIT/NOPB	ACTIVE	TO-220	NDE	3	45	RoHS & Green	SN	Level-1-NA-UNLIM	-40 to 125	LP2954AIT	Samples
LP2954IM/NOPB	ACTIVE	SOIC	D	8	95	RoHS & Green	SN	Level-1-260C-UNLIM	-40 to 125	LP2954IM	Samples
LP2954IMX/NOPB	ACTIVE	SOIC	D	8	2500	RoHS & Green	SN	Level-1-260C-UNLIM	-40 to 125	LP2954IM	Samples
LP2954IS/NOPB	ACTIVE	DDPAK/ TO-263	KTT	3	45	RoHS-Exempt & Green	SN	Level-3-245C-168 HR	-40 to 125	LP2954IS	Samples
LP2954ISX/NOPB	ACTIVE	DDPAK/ TO-263	KTT	3	500	RoHS-Exempt & Green	SN	Level-3-245C-168 HR	-40 to 125	LP2954IS	Samples
LP2954IT/NOPB	ACTIVE	TO-220	NDE	3	45	RoHS & Green	SN	Level-1-NA-UNLIM	-40 to 125	LP2954IT	Samples

(1) The marketing status values are defined as follows:

ACTIVE: Product device recommended for new designs.

LIFEBUY: TI has announced that the device will be discontinued, and a lifetime-buy period is in effect.

NRND: Not recommended for new designs. Device is in production to support existing customers, but TI does not recommend using this part in a new design.

PREVIEW: Device has been announced but is not in production. Samples may or may not be available.

OBSELETE: TI has discontinued the production of the device.

(2) **RoHS:** TI defines "RoHS" to mean semiconductor products that are compliant with the current EU RoHS requirements for all 10 RoHS substances, including the requirement that RoHS substance do not exceed 0.1% by weight in homogeneous materials. Where designed to be soldered at high temperatures, "RoHS" products are suitable for use in specified lead-free processes. TI may reference these types of products as "Pb-Free".

RoHS Exempt: TI defines "RoHS Exempt" to mean products that contain lead but are compliant with EU RoHS pursuant to a specific EU RoHS exemption.

Green: TI defines "Green" to mean the content of Chlorine (Cl) and Bromine (Br) based flame retardants meet JS709B low halogen requirements of <=1000ppm threshold. Antimony trioxide based flame retardants must also meet the <=1000ppm threshold requirement.

- (3) MSL, Peak Temp. - The Moisture Sensitivity Level rating according to the JEDEC industry standard classifications, and peak solder temperature.
- (4) There may be additional marking, which relates to the logo, the lot trace code information, or the environmental category on the device.
- (5) Multiple Device Markings will be inside parentheses. Only one Device Marking contained in parentheses and separated by a "~" will appear on a device. If a line is indented then it is a continuation of the previous line and the two combined represent the entire Device Marking for that device.
- (6) Lead finish/Ball material - Orderable Devices may have multiple material finish options. Finish options are separated by a vertical ruled line. Lead finish/Ball material values may wrap to two lines if the finish value exceeds the maximum column width.

Important Information and Disclaimer:The information provided on this page represents TI's knowledge and belief as of the date that it is provided. TI bases its knowledge and belief on information provided by third parties, and makes no representation or warranty as to the accuracy of such information. Efforts are underway to better integrate information from third parties. TI has taken and continues to take reasonable steps to provide representative and accurate information but may not have conducted destructive testing or chemical analysis on incoming materials and chemicals. TI and TI suppliers consider certain information to be proprietary, and thus CAS numbers and other limited information may not be available for release.

In no event shall TI's liability arising out of such information exceed the total purchase price of the TI part(s) at issue in this document sold by TI to Customer on an annual basis.

TAPE AND REEL INFORMATION

QUADRANT ASSIGNMENTS FOR PIN 1 ORIENTATION IN TAPE



*All dimensions are nominal

Device	Package Type	Package Drawing	Pins	SPQ	Reel Diameter (mm)	Reel Width W1 (mm)	A0 (mm)	B0 (mm)	K0 (mm)	P1 (mm)	W (mm)	Pin1 Quadrant
LP2954AIMX/NOPB	SOIC	D	8	2500	330.0	12.4	6.5	5.4	2.0	8.0	12.0	Q1
LP2954AISX/NOPB	DDPAK/ TO-263	KTT	3	500	330.0	24.4	10.75	14.85	5.0	16.0	24.0	Q2
LP2954IMX/NOPB	SOIC	D	8	2500	330.0	12.4	6.5	5.4	2.0	8.0	12.0	Q1
LP2954ISX/NOPB	DDPAK/ TO-263	KTT	3	500	330.0	24.4	10.75	14.85	5.0	16.0	24.0	Q2

TAPE AND REEL BOX DIMENSIONS

*All dimensions are nominal

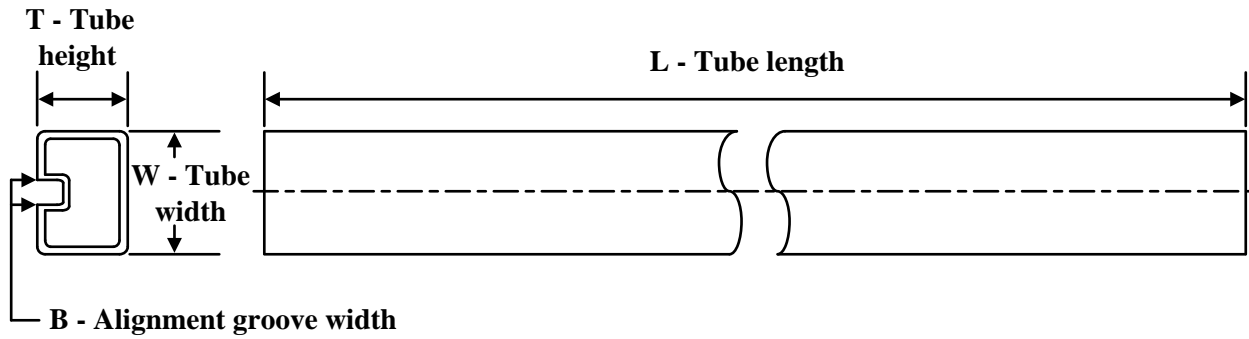
Device	Package Type	Package Drawing	Pins	SPQ	Length (mm)	Width (mm)	Height (mm)
LP2954AIMX/NOPB	SOIC	D	8	2500	367.0	367.0	35.0
LP2954AISX/NOPB	DDPAK/TO-263	KTT	3	500	367.0	367.0	45.0
LP2954IMX/NOPB	SOIC	D	8	2500	367.0	367.0	35.0
LP2954ISX/NOPB	DDPAK/TO-263	KTT	3	500	367.0	367.0	45.0

TUBE

*All dimensions are nominal

Device	Package Name	Package Type	Pins	SPQ	L (mm)	W (mm)	T (μm)	B (mm)
LP2954AIM	D	SOIC	8	95	495	8	4064	3.05
LP2954AIM	D	SOIC	8	95	495	8	4064	3.05
LP2954AIM/NOPB	D	SOIC	8	95	495	8	4064	3.05
LP2954AIS/NOPB	KTT	TO-263	3	45	502	25	8204.2	9.19
LP2954AIT/NOPB	NDE	TO-220	3	45	502	33	6985	4.06
LP2954IM/NOPB	D	SOIC	8	95	495	8	4064	3.05
LP2954IS/NOPB	KTT	TO-263	3	45	502	25	8204.2	9.19
LP2954IT/NOPB	NDE	TO-220	3	45	502	33	6985	4.06

NDE0003B

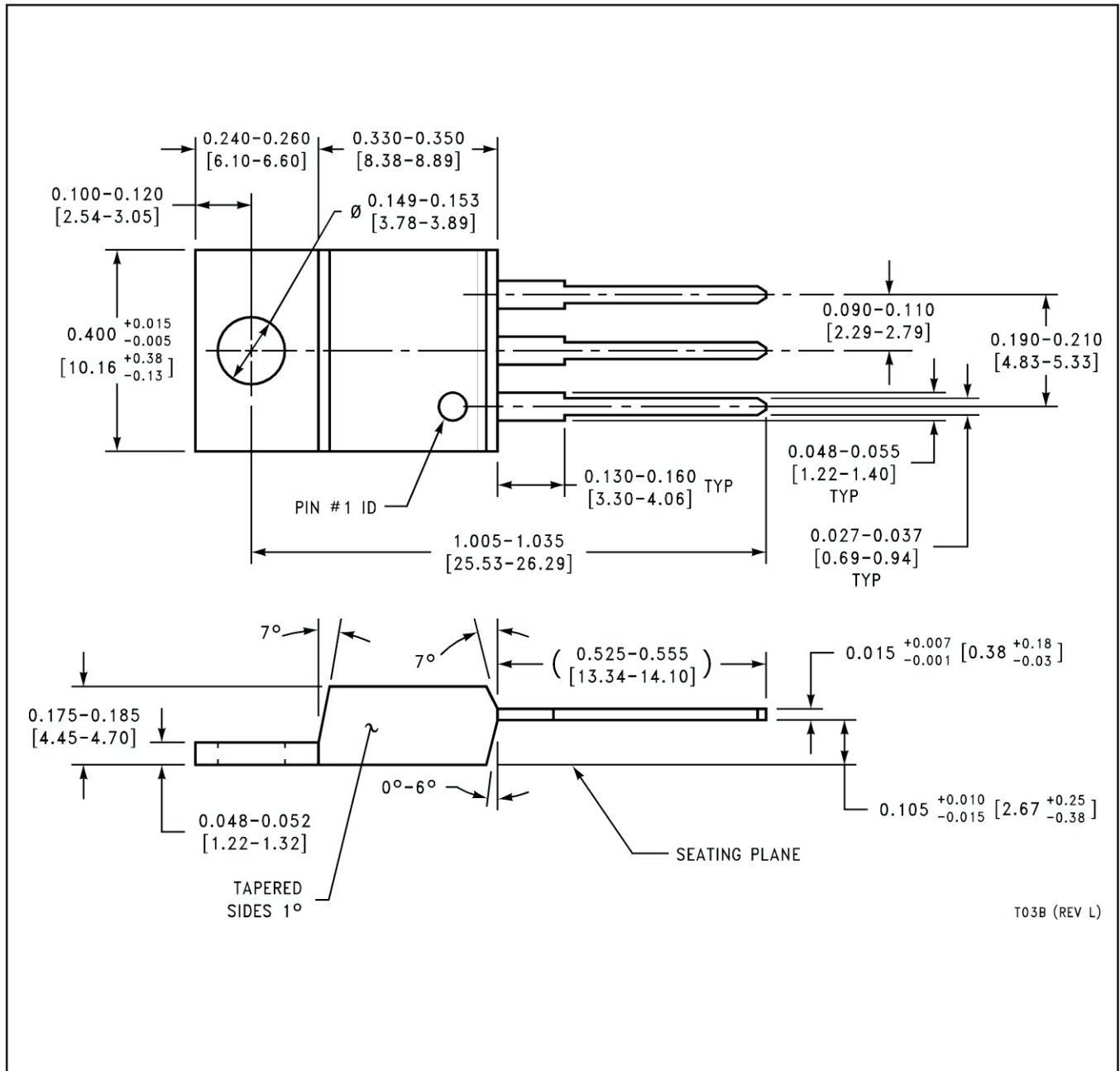

KTT0003B

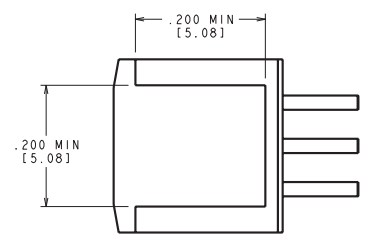
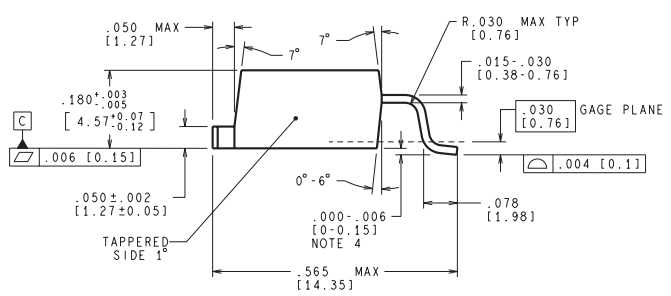
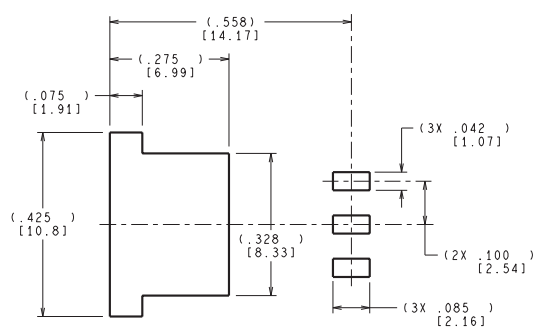
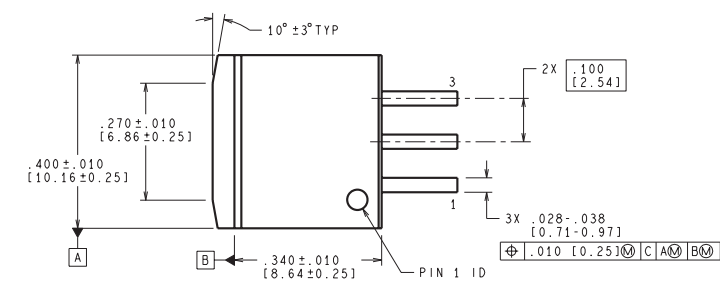

BOTTOM SIDE OF PACKAGE

CONTROLLING DIMENSION IS INCH
 VALUES IN [] ARE MILLIMETERS
 DIMENSIONS IN () FOR REFERENCE ONLY

TS3B (Rev F)



D0008A

PACKAGE OUTLINE

SOIC - 1.75 mm max height

SMALL OUTLINE INTEGRATED CIRCUIT



4214825/C 02/2019

NOTES:

1. Linear dimensions are in inches [millimeters]. Dimensions in parenthesis are for reference only. Controlling dimensions are in inches. Dimensioning and tolerancing per ASME Y14.5M.
2. This drawing is subject to change without notice.
3. This dimension does not include mold flash, protrusions, or gate burrs. Mold flash, protrusions, or gate burrs shall not exceed $.006$ [0.15] per side.
4. This dimension does not include interlead flash.
5. Reference JEDEC registration MS-012, variation AA.

EXAMPLE BOARD LAYOUT

D0008A

SOIC - 1.75 mm max height

SMALL OUTLINE INTEGRATED CIRCUIT



LAND PATTERN EXAMPLE
 EXPOSED METAL SHOWN
 SCALE:8X



SOLDER MASK DETAILS

4214825/C 02/2019

NOTES: (continued)

- 6. Publication IPC-7351 may have alternate designs.
- 7. Solder mask tolerances between and around signal pads can vary based on board fabrication site.

EXAMPLE STENCIL DESIGN

D0008A

SOIC - 1.75 mm max height

SMALL OUTLINE INTEGRATED CIRCUIT



SOLDER PASTE EXAMPLE
BASED ON .005 INCH [0.125 MM] THICK STENCIL
SCALE:8X

4214825/C 02/2019

NOTES: (continued)

8. Laser cutting apertures with trapezoidal walls and rounded corners may offer better paste release. IPC-7525 may have alternate design recommendations.
9. Board assembly site may have different recommendations for stencil design.

勝特力電材超市-龍山店 886-3-5773766
勝特力電材超市-光復店 886-3-5729570
勝特力電子(上海) 86-21-34970699
勝特力電子(深圳) 86-755-83298787
<http://www.100y.com.tw>