



勝特力材料 886-3-5753170  
 勝特力电子(上海) 86-21-34970699  
 勝特力电子(深圳) 86-755-83298787  
 Http://www.100y.com.tw

**L4963**  
**L4963D**

## 1.5A SWITCHING REGULATOR

- 1.5A OUTPUT LOAD CURRENT
- 5.1 TO 36V OUTPUT VOLTAGE RANGE
- DISCONTINUOUS VARIABLE FREQUENCY MODE
- PRECISE (+/-2%) ON CHIP REFERENCE
- VERY HIGH EFFICIENCY
- VERY FEW EXTERNAL COMPONENTS
- NO FREQ. COMPENSATION REQUIRED
- RESET AND POWER FAIL OUTPUT FOR MICROPROCESSOR
- INTERNAL CURRENT LIMITING
- THERMAL SHUTDOWN

### DESCRIPTION

The L4963 is a monolithic power switching regulator delivering 1.5A at 5.1V. The output voltage is adjustable from 5.1V to 36V, working in discontinuous variable frequency mode. Features of the device include remote inhibit, internal current limiting and thermal protection, reset and power fail outputs for microprocessor.

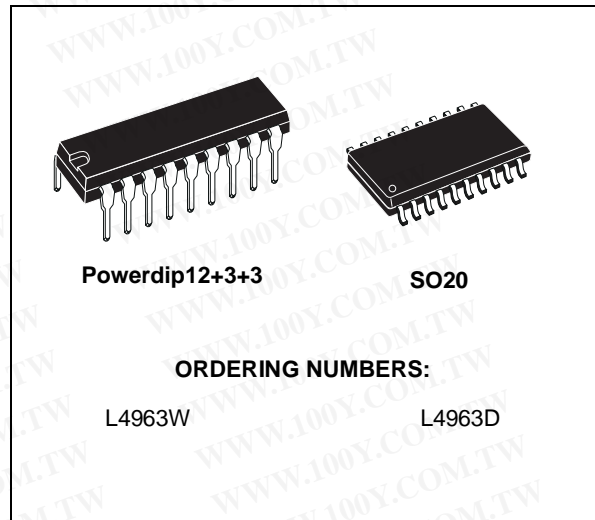

The L4963 is mounted in a 12+3+3 lead Powerdip (L4963) and SO20 large (L4963D) plastic packages and requires very few external components.

### BLOCK DIAGRAM

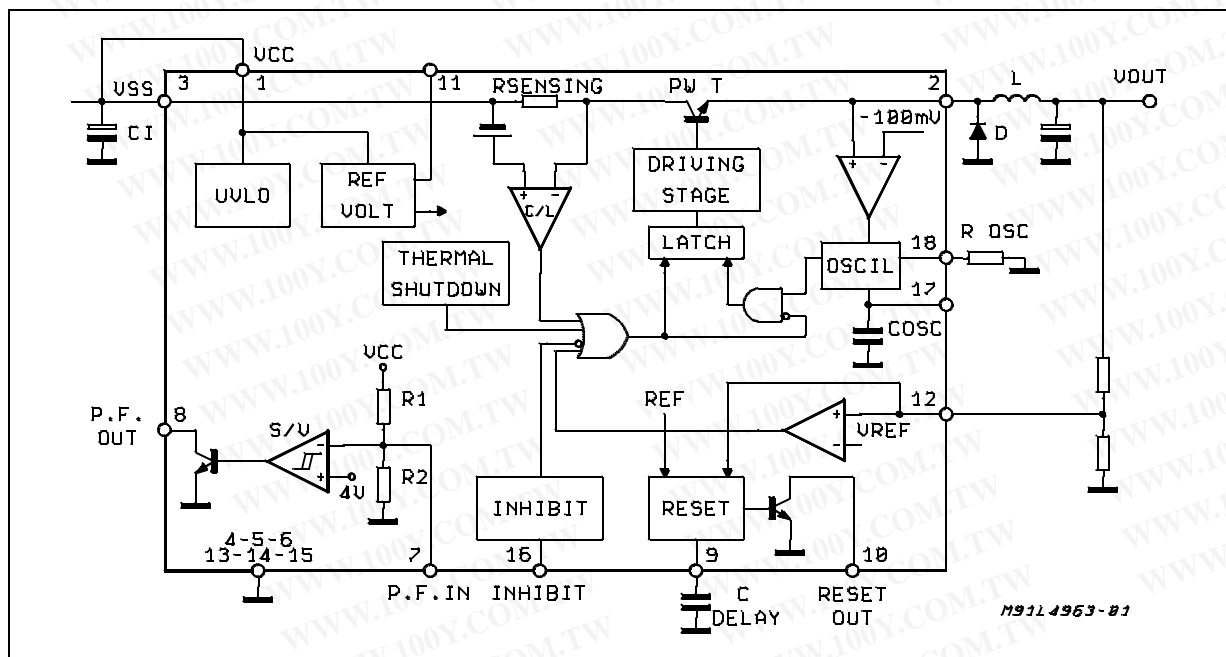

# L4963 - L4963D

## ABSOLUTE MAXIMUM RATINGS

Symbol		Parameter	Value	Unit
SO20	Powerdip			
$V_i$		Input Voltage (pin 1 and pin 3 connected together)	47	V
$V_3-V_2$		Input to Output Voltage Difference	47	V
$V_2$		Negative Output DC Voltage	-1	V
$V_2$		Negative Output Peak Voltage at $t=0.2 \mu s, f=50kHz$	-5	V
$V_8$	$V_7$	Power Fail Input	25	V
$V_9, V_{11}$	$V_8, V_{10}$	Reset and Power Fail Output	$V_i$	
$V_{10}$	$V_9$	Reset Delay Input	5.5	V
$V_{13}, V_{18}$	$V_{12}, V_{16}$	Feedback and Inhibit Inputs	7	V
$V_{19}, V_{20}$	$V_{17}, V_{18}$	Oscillator Inputs	5.5	V
$P_{tot}$		Total Power Dissipation $T_{pins} \leq 90^\circ C$ (Power DIP) ( $T_{amb} = 70^\circ C$ no copper area on PCB) ( $T_{amb} = 70^\circ C, 4cm^2$ copper area on PCB)	5 1.3 2	W W W
$T_{stg}, T_j$		Storage & Junction Temperature ( $T_{amb} = 70^\circ C, 6cm^2$ copper area on PCB)	-40 to 150 1.45	$^\circ C$ W
$P_{tot}$		Total Power Dissipation $T_{pins} \leq 90^\circ C$ (SO20L)	4	W

## PIN CONNECTION (top view)

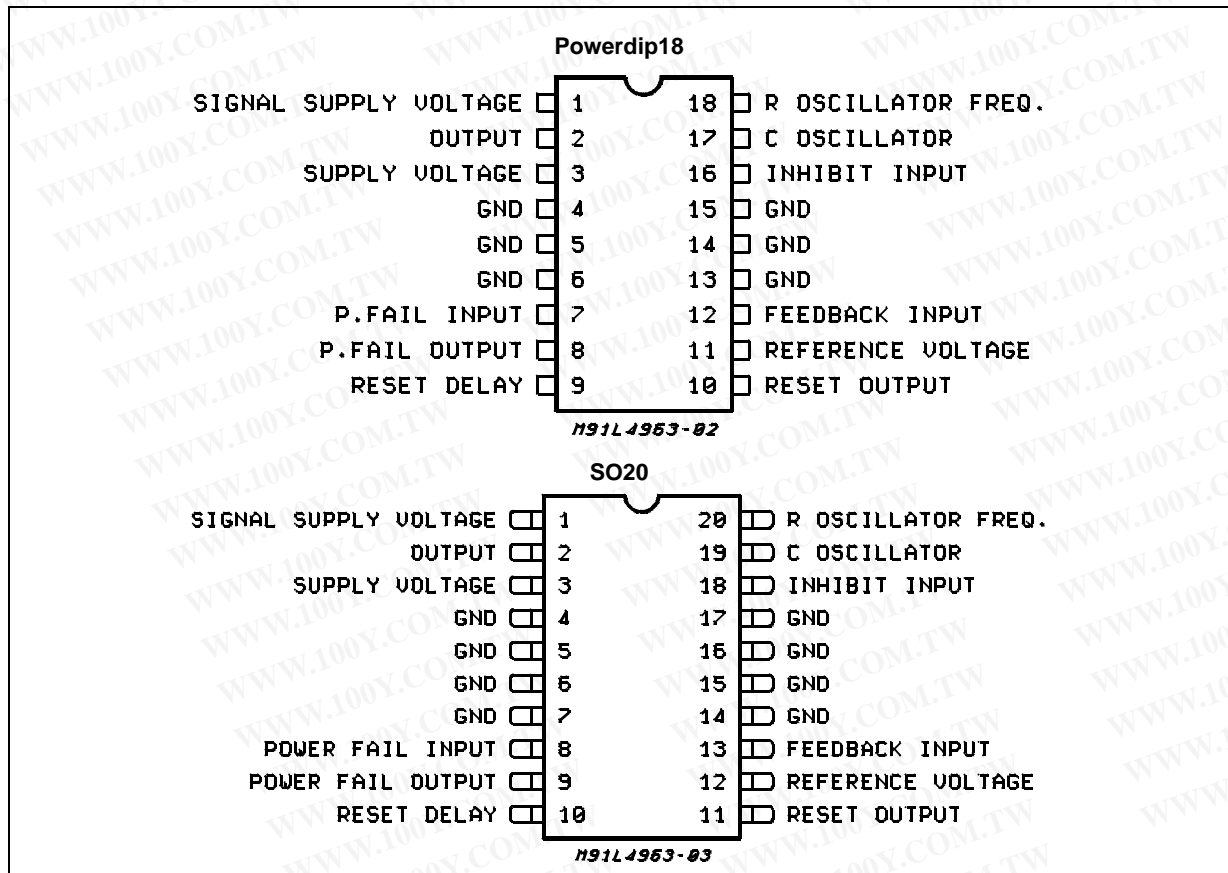

## PIN FUNCTIONS

SO20L	Power DIP	Name	Description
1	1	SIGNAL SUPPLY VOLTAGE	Must be Connected to pin 3
2	2	OUTPUT	Regulator output
3	3	SUPPLY VOLTAGE	Unregulated voltage input. An internal regulator powers the internal logic.
4, 5, 6, 7 14, 15, 16, 17	4, 5, 6 13, 14, 15	GROUND	Common ground terminal
8	7	POWER FAIL INPUT	Input of the power fail circuit. The threshold can be modified introducing an external voltage divider between the Supply Voltage and GND.
9	8	POWER FAIL OUTPUT	Open collector power fail signal output. This output is high when the supply voltage is safe.
10	9	RESET DELAY	A capacitor connected between this terminal and ground determines the reset signal delay time.
11	10	RESET OUTPUT	Open collector reset signal output. This output is high when the output voltage value is correct.
12	11	REFERENCE VOLTAGE	Reference voltage output.
13	12	FEEDBACK INPUT	Feedback terminal of the regulation loop. The output is connected directly to this terminal for 5.1V operation; it is connected via a divider for higher voltages.
18	16	INHIBIT INPUT	TTL level remote inhibit. A logic low level on this input disables the device.
19	17	C OSCILLATOR	Oscillator waveform. A capacitor connected between this terminal and ground modifies the maximum oscillator frequency.
20	18	R OSCILLATOR FREQ.	A resistor connected between this terminal and ground defines the maximum switching frequency.

## THERMAL DATA

Symbol	Parameter		SO20	Powerdip	Unit
$R_{th\ j-pins}$	Thermal Resistance Junction to Pins	max.	15	12	°C/W
$R_{th\ j-amb}$	Thermal Resistance Junction to Ambient (*)	max.	85	80	°C/W

(\*) See Fig. 28

**CIRCUIT DESCRIPTION (Refer to Block Diagram)**

The L4963 is a monolithic stepdown regulator providing 1.5A at 5.1V working in discontinuous variable frequency mode. In normal operation the device resonates at a frequency depending primarily on the inductance value, the input and output voltage and the load current. The maximum switching however can be limited by an internal oscillator, which can be programmed by only one external resistor.

The fundamental regulation loop consists of two comparators, a precision 5.1V on-chip reference and a drive latch. Briefly the operation is as follows: when the choke ends its discharge the catch free-wheeling recirculation filter diode begins to come out of forward conduction so the output voltage of the device approaches ground. When the output voltage reaches  $-0.1V$  the internal comparator sets the latch and the power stage is turned on. Then the inductor current rises linearly until the voltage sensed at the feedback input reaches the 5.1V reference.

The second comparator then resets the latch and the output stage is turned off. The current in the choke falls linearly until it is fully discharged, then the cycle repeats. Closing the loop directly gives an output voltage of 5.1V. Higher output voltages are

obtained by inserting a voltage divider and this method of control requires no frequency compensation network. At output voltages greater than 5.1V the available output current must be derated due to the increased power dissipation of the device.

Output overload protection is provided by an internal current limiter. The load current is sensed by a on-chip metal resistor connected to a comparator which resets the latch and turns off the power stage in overload condition. The reset circuits (see fig. 1) generates an output high signal when the output voltage value is correct. It has an open collector output and the output signal delay time can be programmed with an external capacitor. A power-fail circuit is also available and is used to monitor the supply voltage. Its output goes high when the supply voltage reaches a pre-programmed threshold set by a voltage divider to its input from the supply to ground. With the input left open the threshold is approximately equal to 5.1V. The output of the power fail is an open collector.

A TTL level inhibit is provided for applications such as remote on/off control. This input is activated by a low logic level and disables circuits operation.

The thermal overload circuit disables the device when the junction temperature is about  $150^{\circ}C$  and has hysteresis to prevent unstable conditions.

**Figure 1: Reset and Power Fail Function**

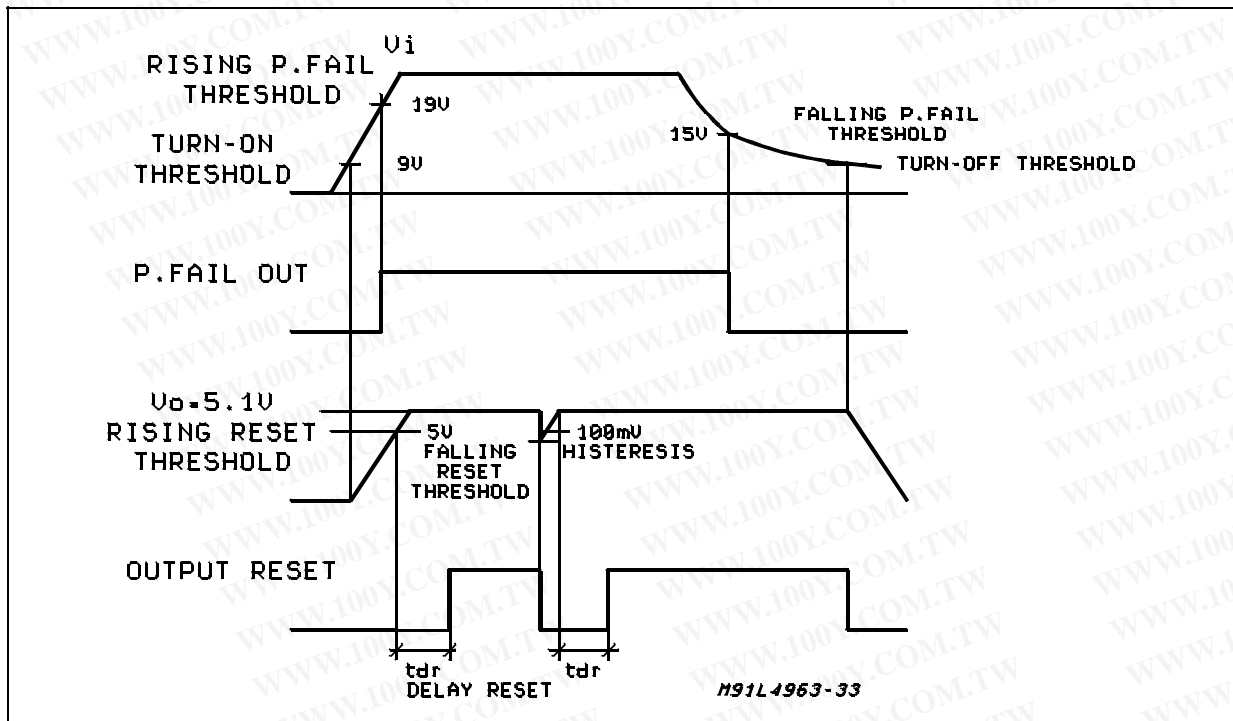

**ELECTRICAL CHARACTERISTIC** (Refer to the test circuit  $V_i = 30V$   $T_j = 25^\circ C$  unless otherwise specified)

Symbol	Parameter	Test Conditions	Min.	Typ.	Max.	Unit	Fig.
--------	-----------	-----------------	------	------	------	------	------

**DYNAMIC CHARACTERISTICS**

$V_o$	Output Voltage Range	$V_i = 46V$ $I_o = 0.5A$	$V_{ref}$		36	V	2
$V_i$	Input Voltage Range	$V_o = V_{ref}$ to $36V$ $I_o = 0.5A$	9		46	V	2
$V_{12}$	Feedback Voltage	$V_i = 9$ to $46V$ $I_o = 0.5A$	5	5.1	5.2	V	2
$I_{12}$	Input Bias Current	$V_i = 15V$ $V_{12} = 6V$ $V_{17f} = 5V$		5	20	$\mu A$	3a
$V_{OS12}$	Input Offset Voltage			5	10	mV	3a
$\Delta V_o$	Line Regulation	$V_i = 9$ to $46V$ $V_o = V_{ref}$ $I_o = 0.5A$		15	50	mV	2
$\Delta V_o$	Load Regulation	$V_o = V_{ref}$ $I_o = 0.5$ to $1.5A$		15	45	mV	2
$V_d$	Dropout Voltage Between pin 3 and pin 2	$I_2 = 3A$ $V_i = 20V$		1.5	2	V	2
$I_{2L}$	Current Limiting	$V_i = 9$ to $46V$ $V_o = V_{ref}$ to $28V$	3.5		6.5	A	2
$I_o$	Maximum Operating Load Current	$V_i = 9$ to $46V$ $V_o = V_{ref}$	1.5			A	2
SVR	Supply Voltage Ripple Rejection	$V_i = 2V_{rms}$ $V_o = V_{ref}$ fripple = $100Hz$ $I_o = 1.5A$	50	56		dB	2
$V_{11}$	Reference Voltage	$V_i = 9$ to $46V$ $0 < I_{11} < 5mA$	5	5.1	5.2	V	3a
	Average Temperature Coefficient of Ref. Volt.	$T_j = 0$ to $125^\circ C$		0.4		mV/ $^\circ C$	-
$\Delta V_{11}$	$V_{ref}$ Line Regulation	$V_i = 9$ to $46V$		10	20	mV	3a
$\Delta V_{11}$	$V_{ref}$ Line Regulation	$I_{ref} = 0$ to $5mA$ $V_i = 46V$ $R_{osc} = 51K\Omega$	65 69	7	15	mV	3a
$\eta$	Efficiency	$I_o = 1.5A$ $V_o = V_{ref}$	65	75		%	2
$T_{sd}$	Thermal Shutdown Junction Temperature		145	150		$^\circ C$	-
	Hysteresis			30		$^\circ C$	-

**DC CHARACTERISTICS**

$I_q$	Quiescent Drain Current	$V_i = 46V$ $I_o = 0mA$	$V_{16} = V_{12} = 0$		14	20	mA	3a
			$V_{16} = V_{ref}$ $V_{12} = 5.3V$		11	16	mA	3a

**INHIBIT**

$V_{16L}$	Low Input Voltage	$V_i = 9$ to $46V$	0.3		0.8	V	2
$V_{16H}$	High Input Voltage	$V_i = 9$ to $46V$	2		5.5	V	2
$I_{16L}$	Input Current with Low Input Voltage	$V_{16} = 0.8V$		50	100	$\mu A$	2
$I_{16L}$	Input Current with High Input Voltage	$V_{16} = 2V$		10	20	$\mu A$	2

## L4963 - L4963D

### ELECTRICAL CHARACTERISTIC (Continued)

Symbol	Parameter	Test Conditions	Min.	Typ.	Max.	Unit	Fig.
--------	-----------	-----------------	------	------	------	------	------

#### RESET

$V_{12}$	Rising Threshold Voltage	$V_i = 9$ to 46V	$V_{ref}$ -150	$V_{ref}$ -100	$V_{ref}$ -50	mV	3b
$V_{12}$	Falling Threshold Voltage	$V_i = 9$ to 46V	$V_{ref}$ -150	$V_{ref}$ -200	$V_{ref}$ -250	mV	3b
$V_{9D}$	Delay Rising Threshold Voltage	$V_7 = OPEN$	4.3	4.5	4.7	V	3b
$V_{9F}$	Delay Falling Threshold Voltage		1	1.5	2	V	3b
$-I_{9SO}$	Delay Source Current	$V_9 = 4.7V$ $V_{12} = 5.3V$	70	110	140	$\mu A$	3b
$I_{9SI}$	Delay Sink Current	$V_9 = 4.7V$ $V_{12} = 4.7V$	10			mA	3b
$I_{10}$	Output Leakage Current	$V_i = 46V$ $V_7 = 8.5V$	50			$\mu A$	3b
$V_{10}$	Output Saturation Volt.	$I_{10} = 15mA$ ; $V_i = 3$ to 46V			0.4	V	3b

#### POWER FAIL

$V_R$	Rising Threshold Voltage	Pin7 = open	17.5	19	20.5	V	3C
$V_F$	Falling Threshold Voltage	Pin7 = open	14.25	15	15.75	V	3c
$V_7$	Rising Threshold Voltage	$V_i = 20V$	4.14	4.5	4.86	V	-
$V_7$	Falling Threshold Voltage	$V_i = 20V$	3.325	3.5	3.675	V	-
$V_s$	Output Saturation Volt.	$I_a = 5mA$			0.4	V	3c
$I_s$	Output Leakage Current	$V_i = 46V$			50	$\mu A$	3c

#### OSCILLATOR

f	Oscillator Frequency	$R_T = 51K\Omega$	46	60	79	kHz	-
f	Oscillator Frequency	$V_i = 9$ to 46V $T_j = 0$ to 125°C $R_T = 51K\Omega$	42		83	kHz	-

Figure 2: Test Circuit

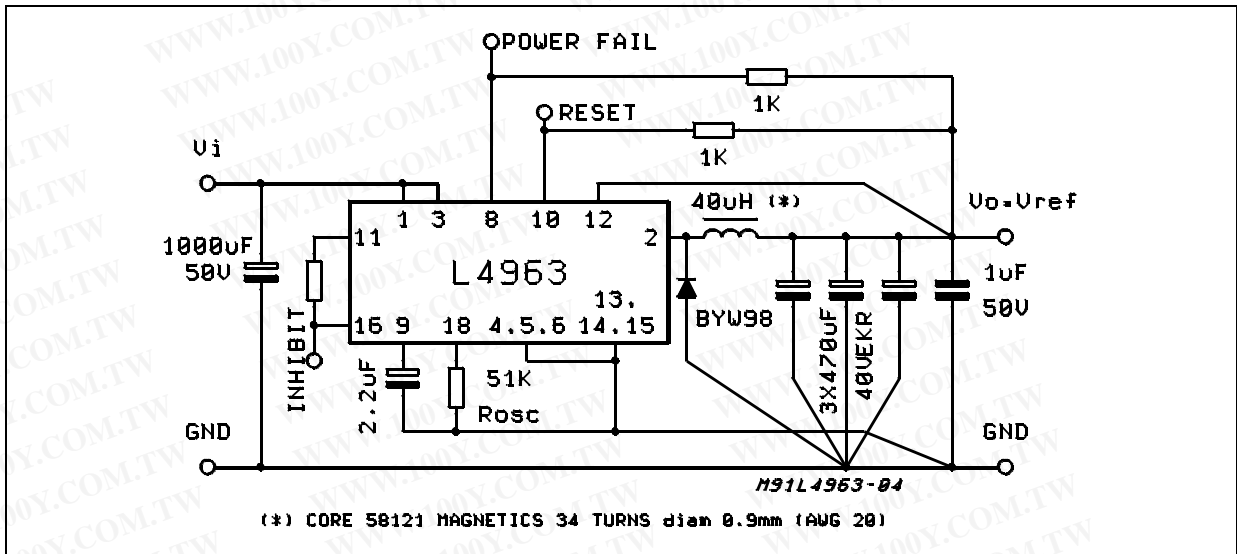

Figure 3: DC Test Circuit

Figure 3a

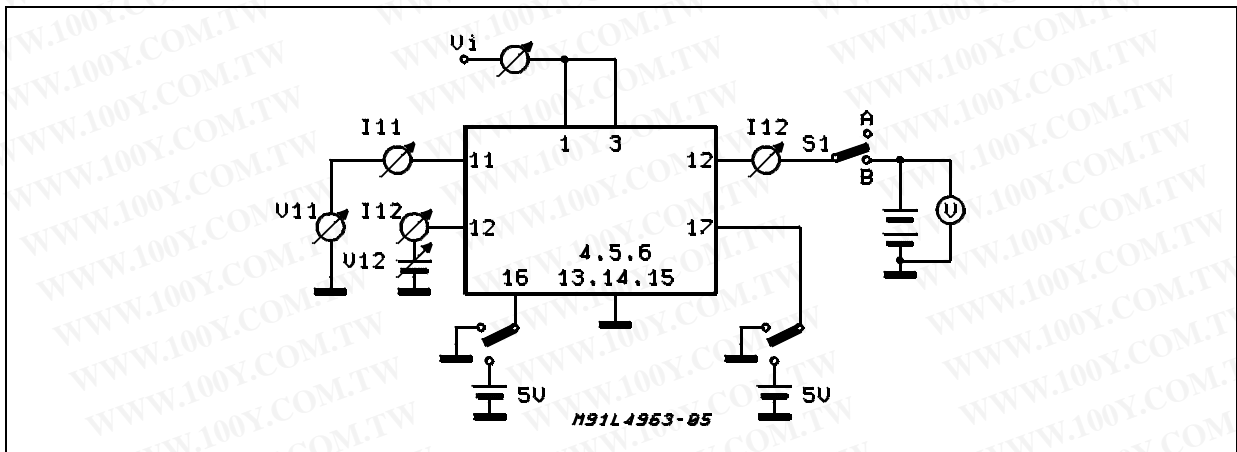

Figure 3b

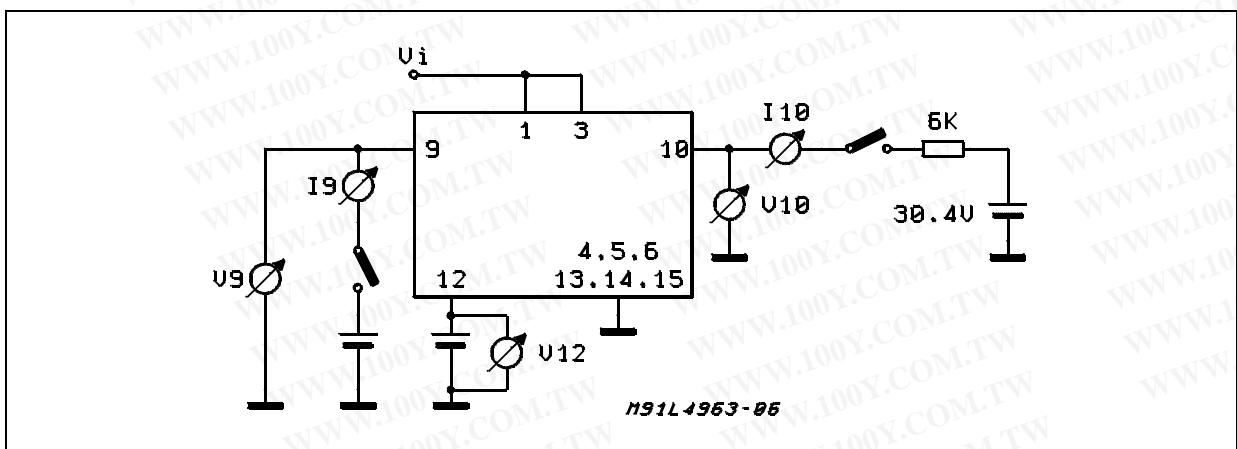

Figure 3c

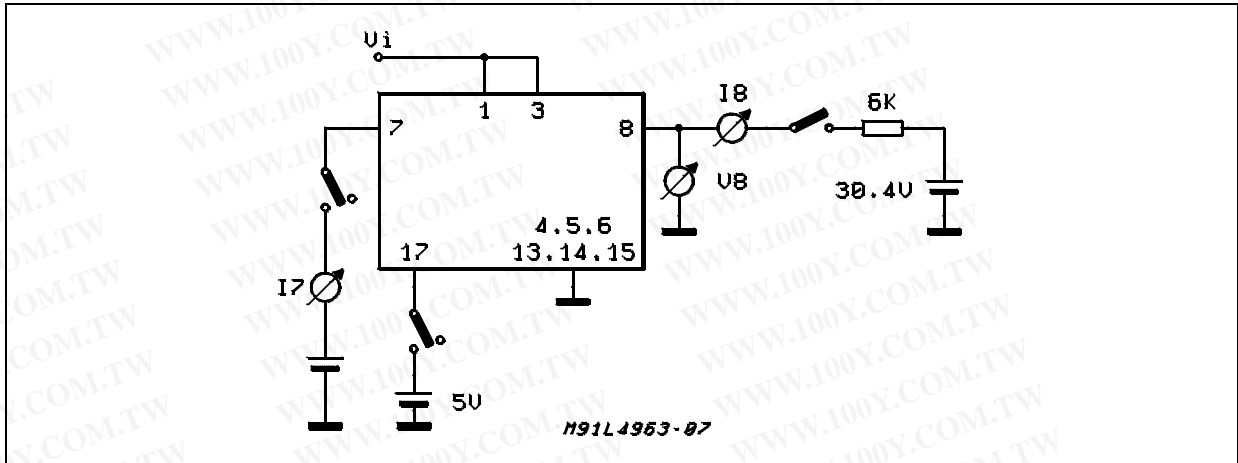

Figure 4: Quiescent Drain Current vs. Supply Voltage (0% Duty Cycle)

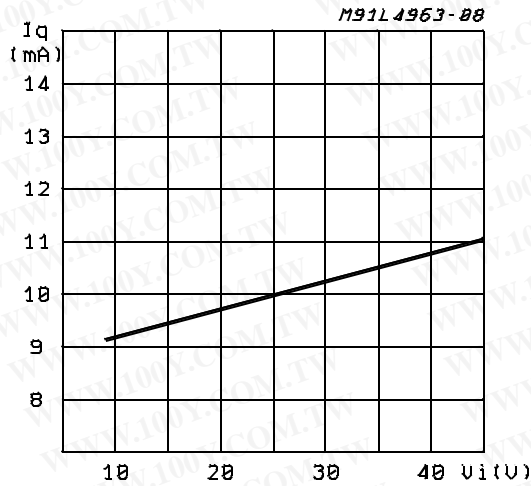

Figure 5: Quiescent Drain Current vs. Supply Voltage (100% Duty Cycle)

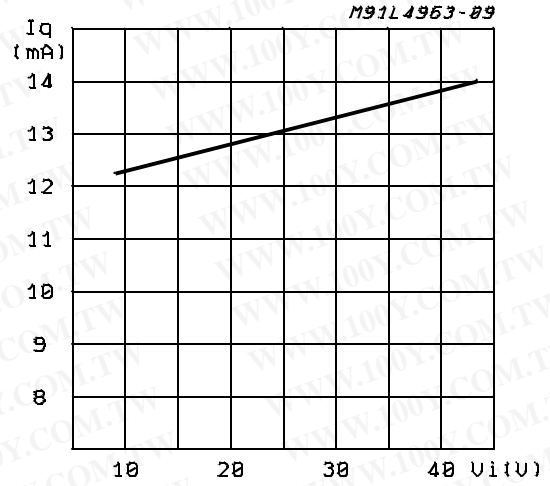

Figure 6: Quiescent Drain Current vs. Junction Temperature (0% Duty Cycle)

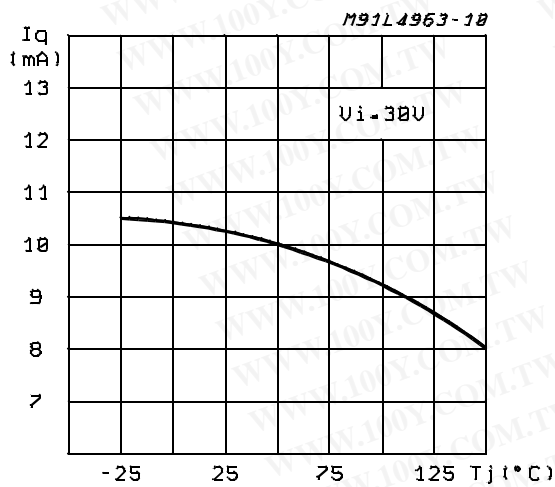

Figure 7: Quiescent Drain Current vs. Junction Temperature (100% Duty Cycle)

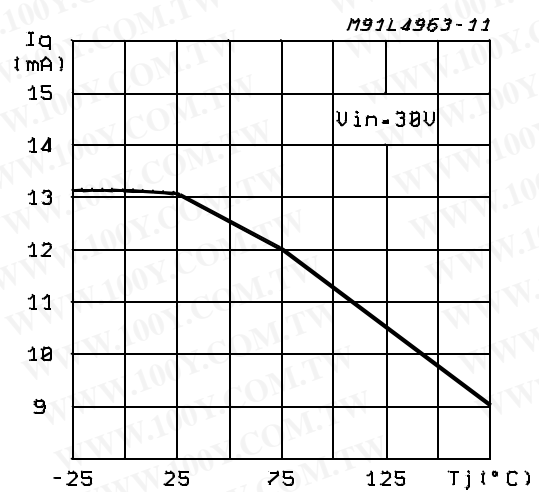

Figure 8: Reference Voltage vs.  $V_i$

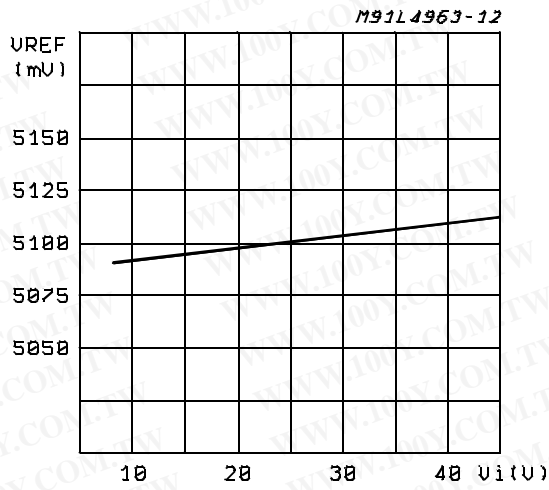

Figure 9: Reference Voltage vs.  $T_j$

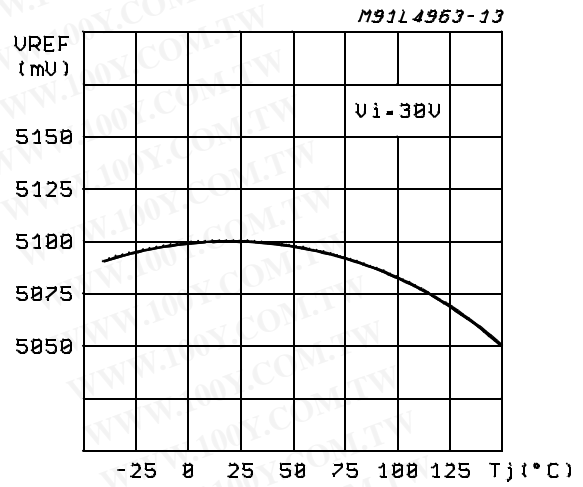

Figure 10: Line Transient Response

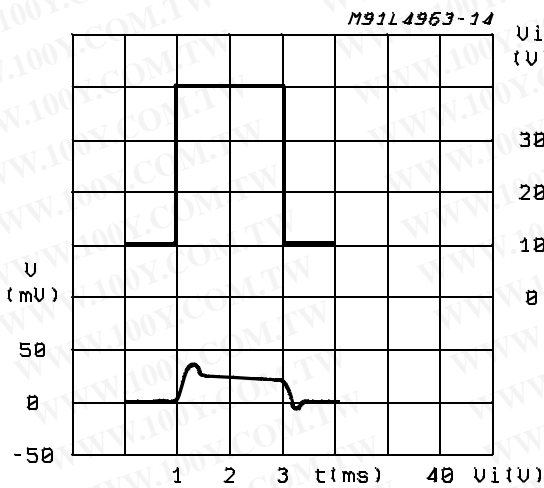

Figure 11: Load Transient

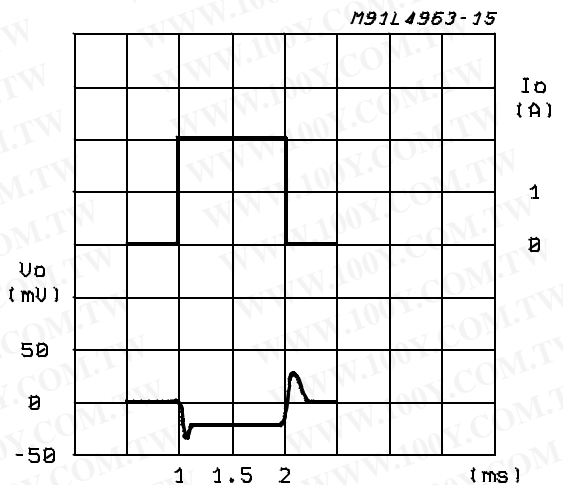

Figure 12: Supply Voltage Ripple Rejection vs. Frequency

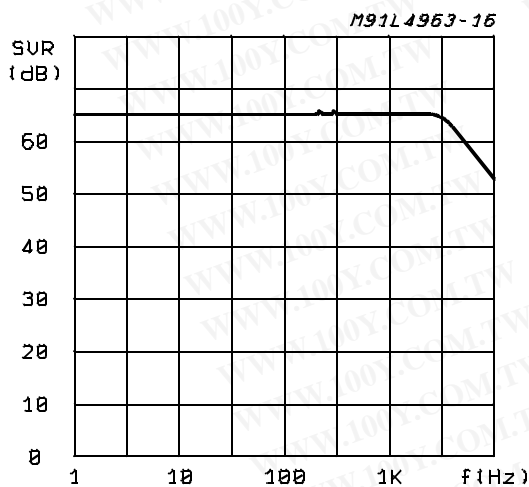
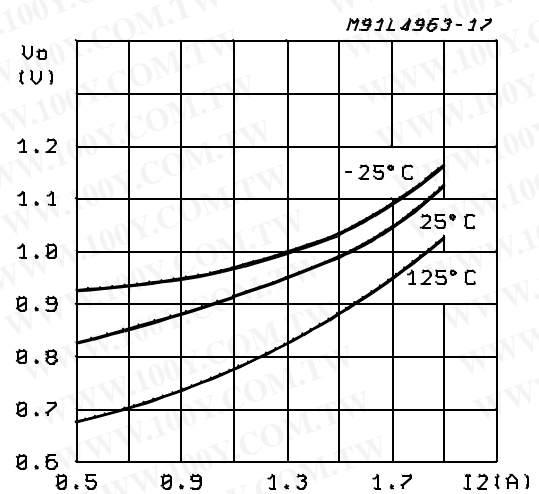
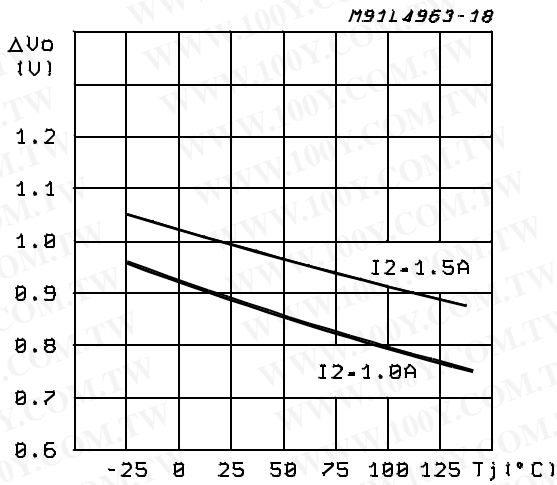

Figure 13: Dropout Voltage Between pin3 and 2 vs. Current at pin2



**Figure 14:** Dropout Voltage Between pin3 and 2 vs. Junction Temperature



**Figure 15:** Maximum Allowable Power Dissipation vs. Ambient Temperature (Powerdip Package Only)

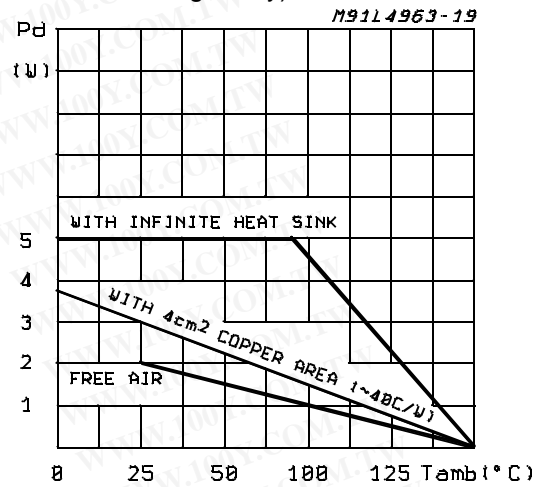

**Figure 16:** Power Dissipation (device only) vs. Input Voltage (Powerdip Package Only)

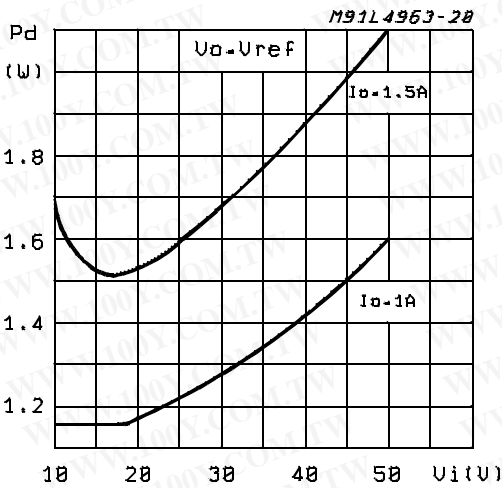

**Figure 17:** Power Dissipation (device only) vs. Output Voltage (Powerdip Package Only)

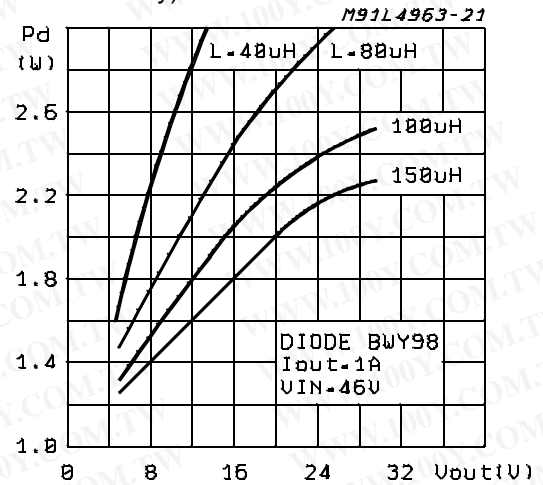

**Figure 18:** Voltage and Current Waveform at pin2

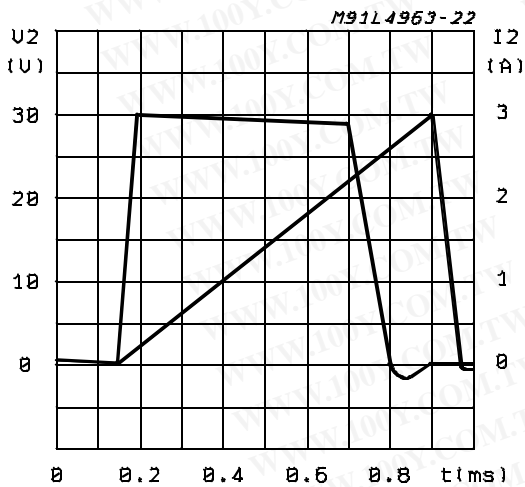

**Figure 19:** Efficiency vs. Output Current (Powerdip Package Only)

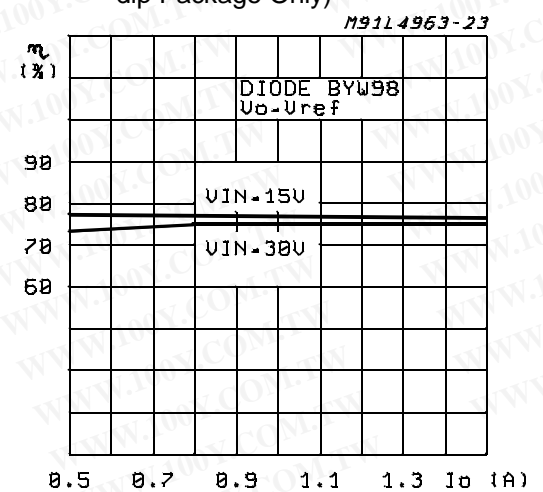

**Figure 20:** Efficiency vs. Output Voltage (Power-dip Package Only)

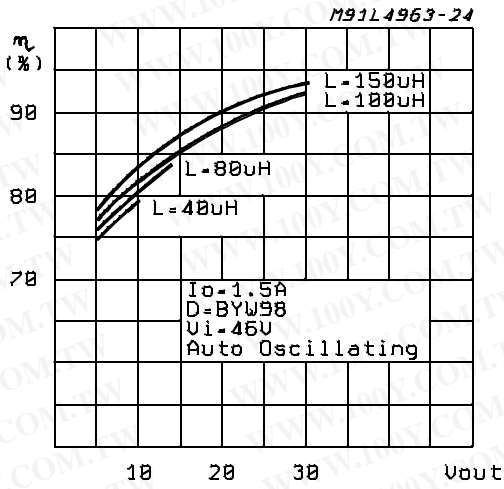

**Figure 21:** Current Limit vs. Junction Temperature  $V_i = 30V$

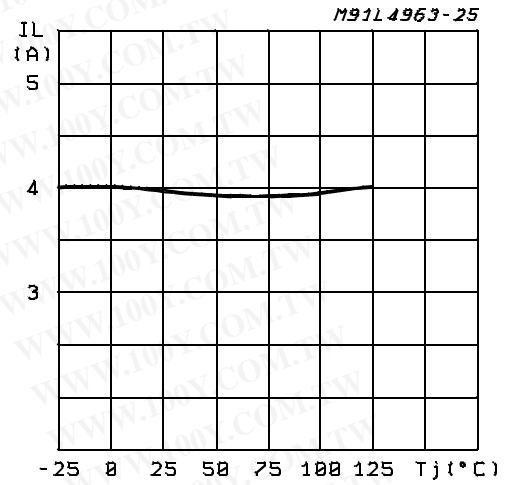

**Figure 22:** Current Limit vs. Input Voltage

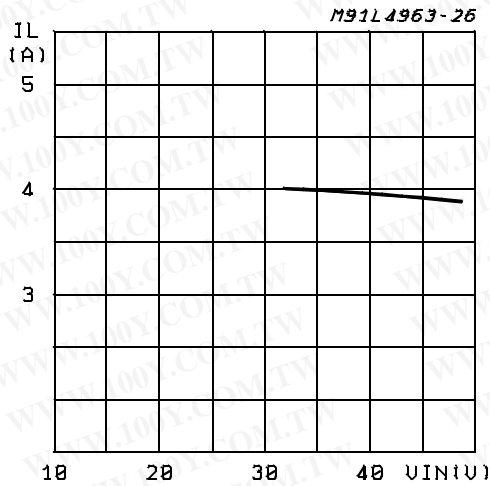

**Figure 23:** Oscillator Frequency vs. R2 (see fig. 26)

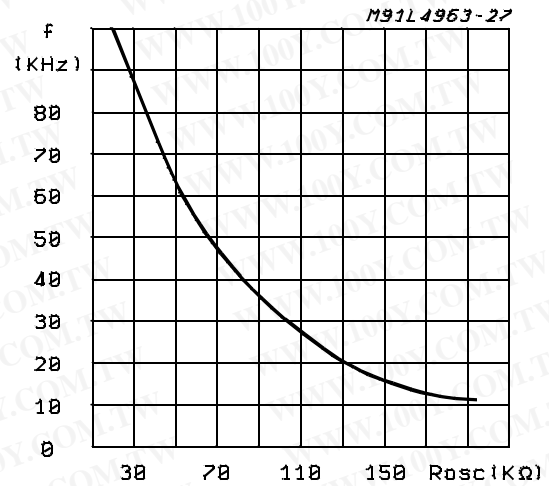

**Figure 24:** Oscillator Frequency vs. Junction Temperature

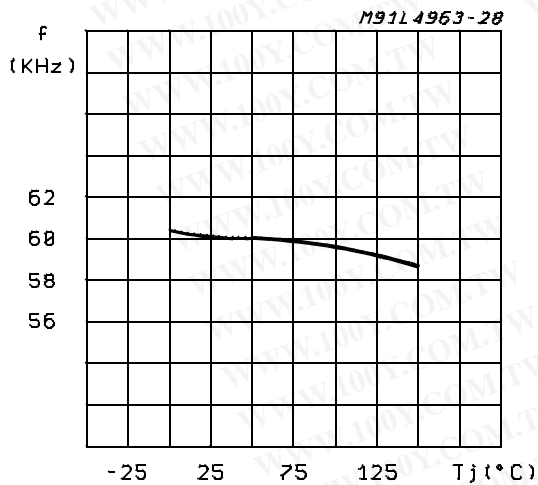

**Figure 25:** Oscillator Frequency vs. Input Voltage

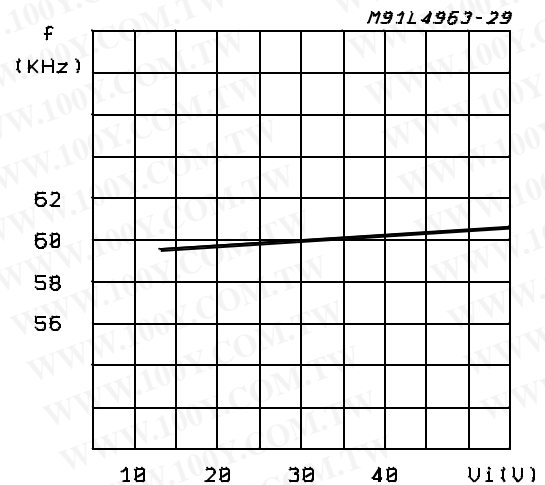



Figure 27: P.C. Board and Component Layout of the Circuit of fig. 26 (Powerdip Package) (1:1 scale).

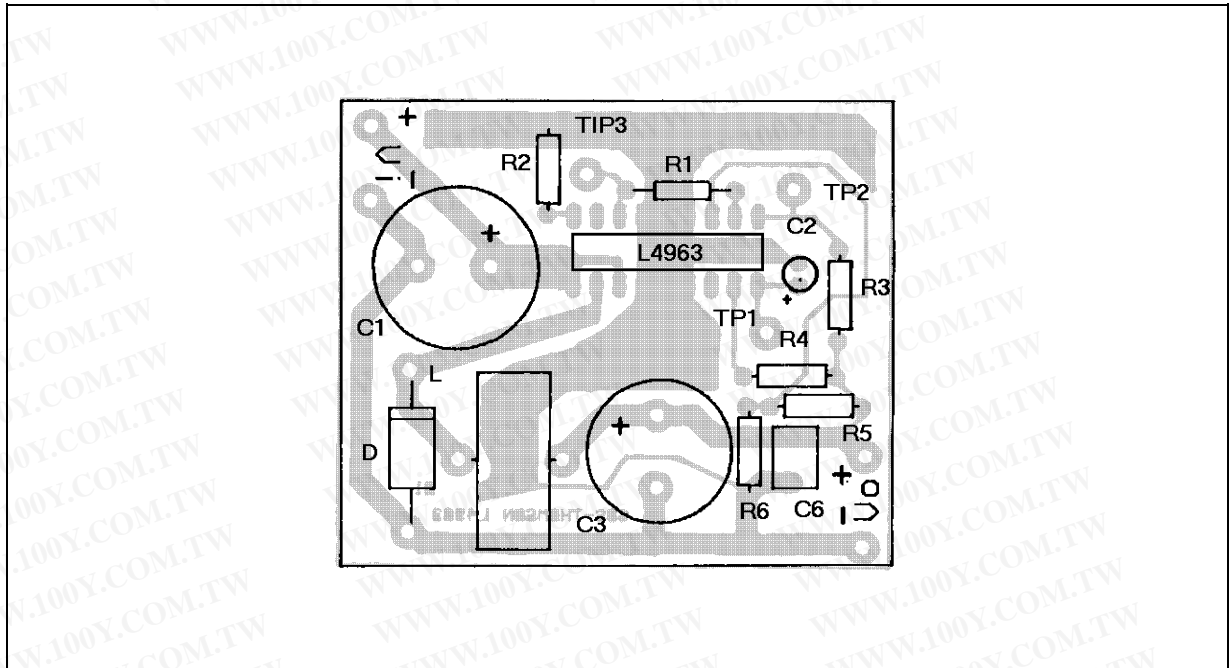

Figure 28: Thermal Characteristics

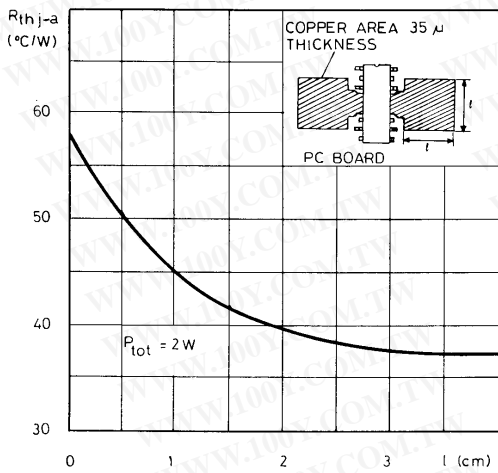
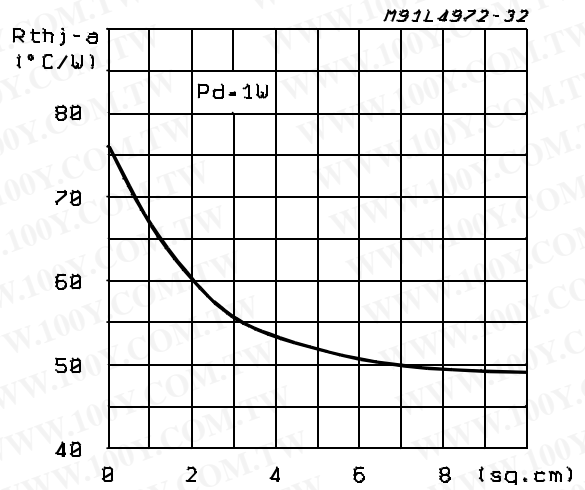

Figure 29: Junction to Ambient Thermal Resistance vs. Area on Board Heatsink (SO20)



## L4963 - L4963D

Figure 30: A Minimal 5.1 Fixed Regulator — Very Few Components are Required

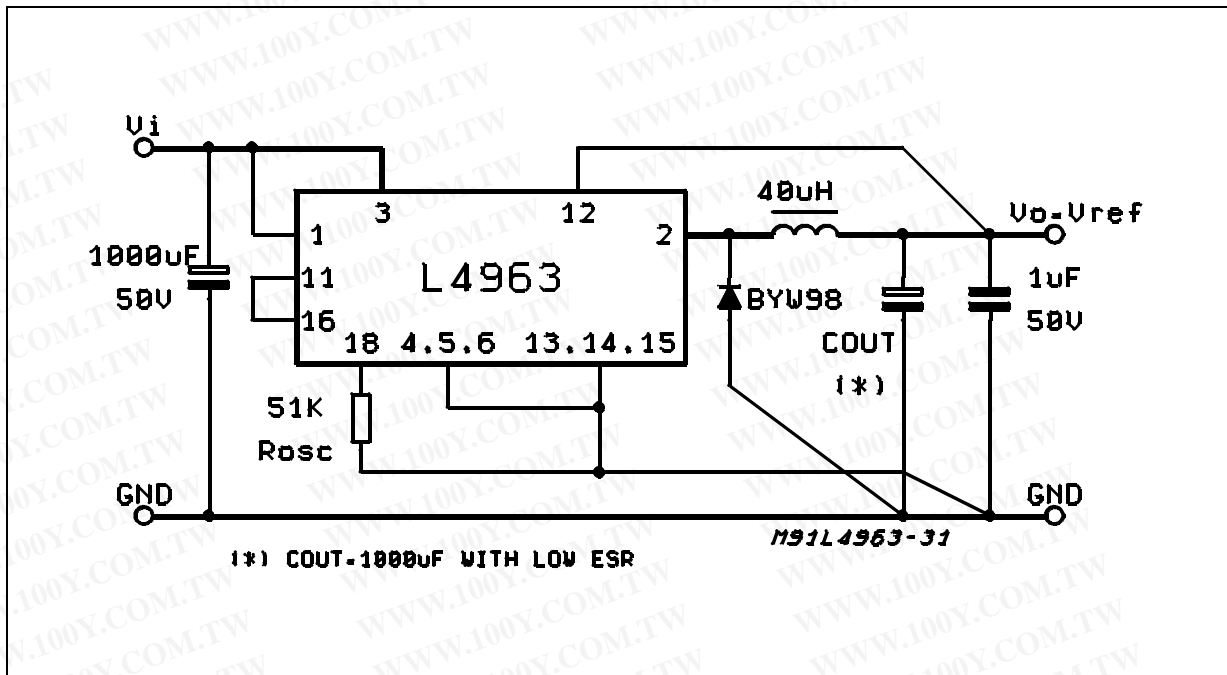
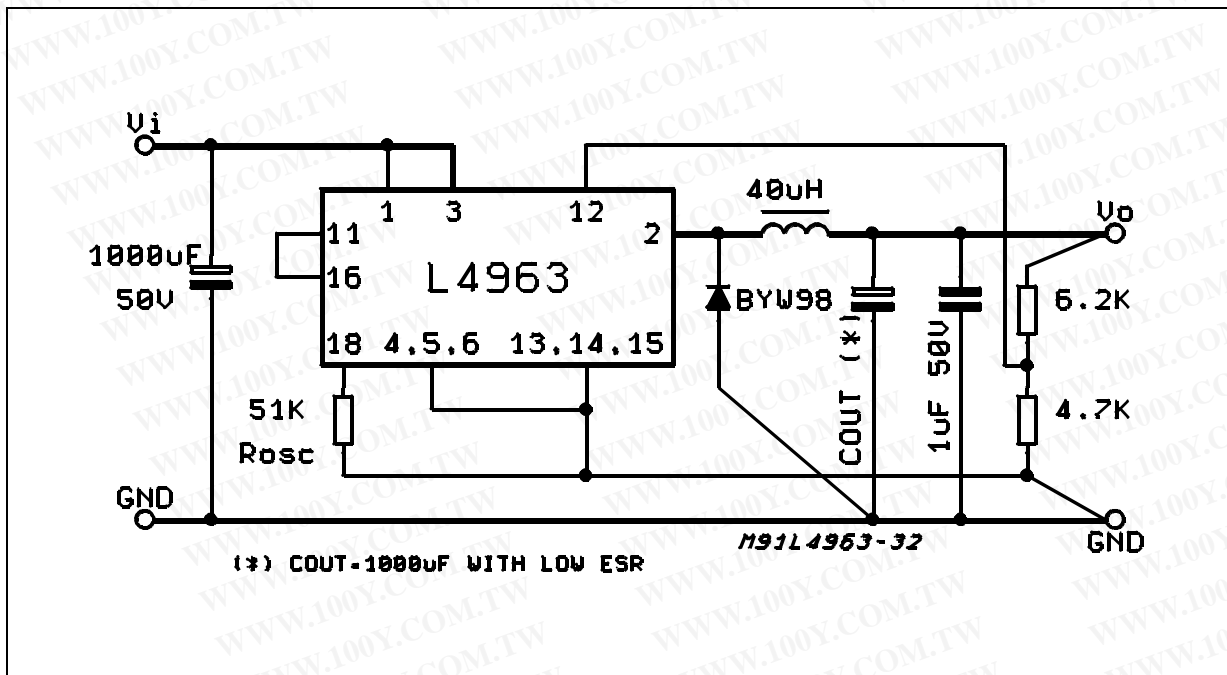
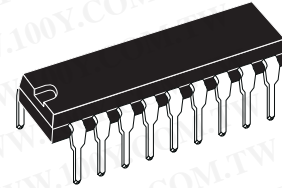

Figure 31: A Minimal Components count for  $V_O = 12V$



DIM.	mm			inch		
	MIN.	TYP.	MAX.	MIN.	TYP.	MAX.
a1	0.51			0.020		
B	0.85		1.40	0.033		0.055
b		0.50			0.020	
b1	0.38		0.50	0.015		0.020
D			24.80			0.976
E		8.80			0.346	
e		2.54			0.100	
e3		20.32			0.800	
F			7.10			0.280
I			5.10			0.201
L		3.30			0.130	
Z			2.54			0.100

## OUTLINE AND MECHANICAL DATA



**Powerdip 18**

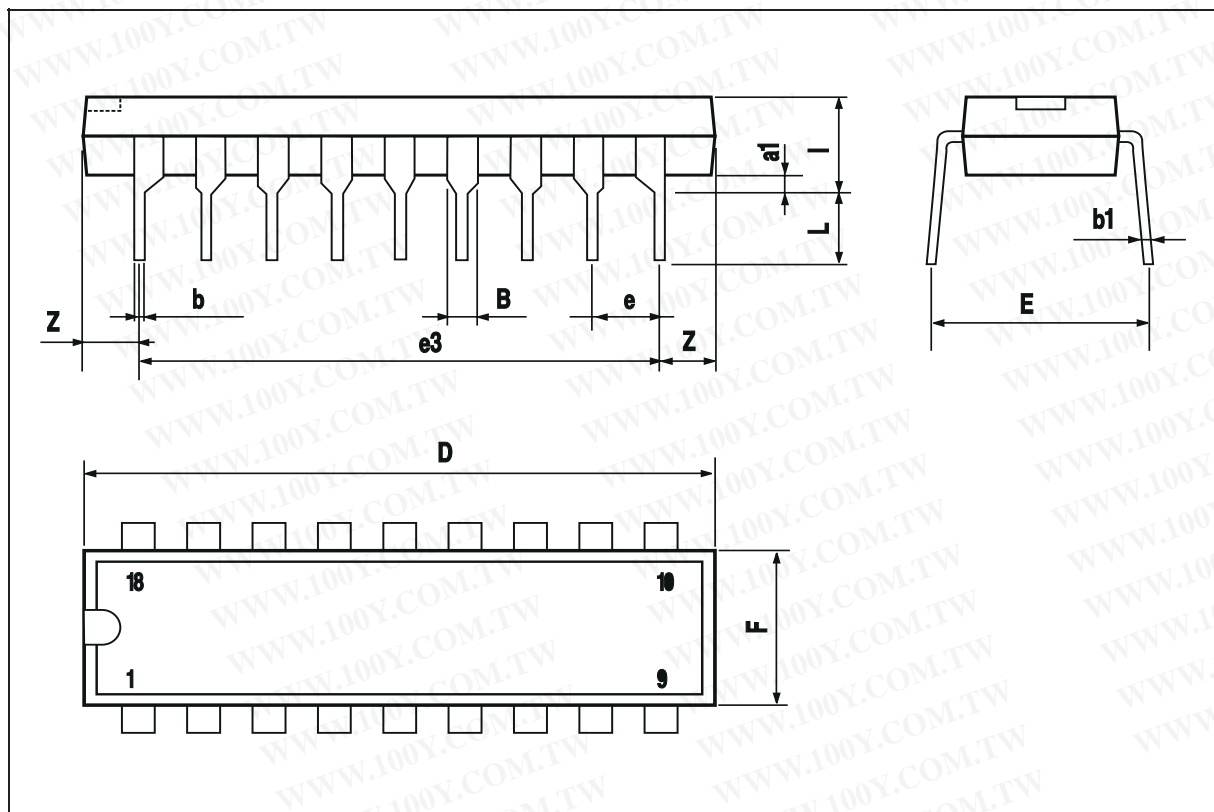

**L4963 - L4963D**

DIM.	mm			inch		
	MIN.	TYP.	MAX.	MIN.	TYP.	MAX.
A	2.35		2.65	0.093		0.104
A1	0.1		0.3	0.004		0.012
B	0.33		0.51	0.013		0.020
C	0.23		0.32	0.009		0.013
D	12.6		13	0.496		0.512
E	7.4		7.6	0.291		0.299
e		1.27			0.050	
H	10		10.65	0.394		0.419
h	0.25		0.75	0.010		0.030
L	0.4		1.27	0.016		0.050
K	0° (min.)8° (max.)					

**OUTLINE AND MECHANICAL DATA**

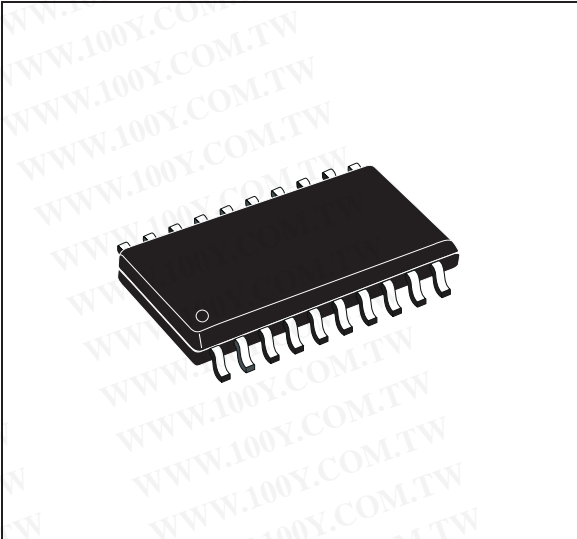

**SO20**

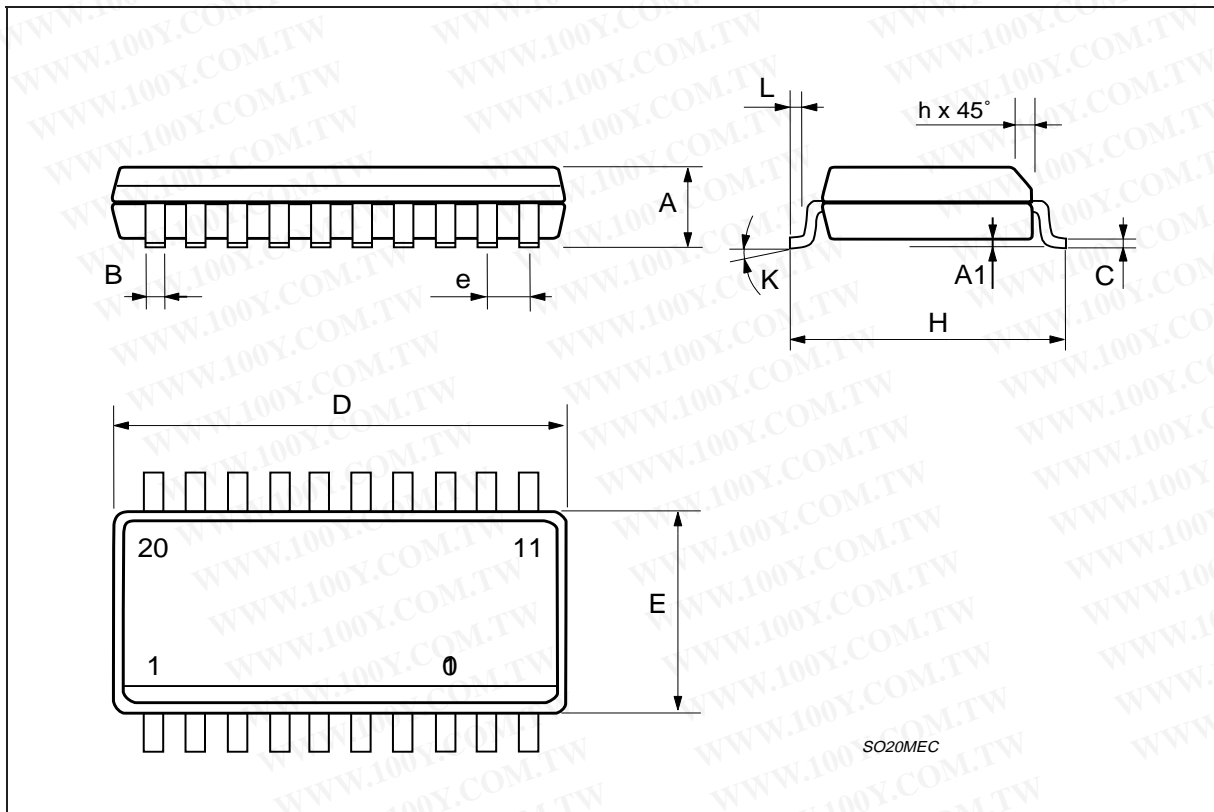

SO20MEC

勝特力材料 886-3-5753170  
勝特力电子(上海) 86-21-34970699  
勝特力电子(深圳) 86-755-83298787  
[Http://www.100y.com.tw](http://www.100y.com.tw)

Information furnished is believed to be accurate and reliable. However, STMicroelectronics assumes no responsibility for the consequences of use of such information nor for any infringement of patents or other rights of third parties which may result from its use. No license is granted by implication or otherwise under any patent or patent rights of STMicroelectronics. Specification mentioned in this publication are subject to change without notice. This publication supersedes and replaces all information previously supplied. STMicroelectronics products are not authorized for use as critical components in life support devices or systems without express written approval of STMicroelectronics.

The ST logo is a registered trademark of STMicroelectronics

© 2000 STMicroelectronics – Printed in Italy – All Rights Reserved

STMicroelectronics GROUP OF COMPANIES

Australia - Brazil - China - Finland - France - Germany - Hong Kong - India - Italy - Japan - Malaysia - Malta - Morocco - Singapore - Spain - Sweden - Switzerland - United Kingdom - U.S.A.

<http://www.st.com>

