

Features

- Compliant to USB specifications
- Dual independent switches control
- 2.7V to 5.5V input voltage
- 500mA minimum continuous current per port
- 110mΩ typical on-resistance
- 1.25A maximum short circuit current limit
- Independent open-drain fault flag pins
- 110μA typical on-state supply current
- 1μA typical off-state supply current
- Output can be forced higher than input (off-state)
- Thermal shutdown
- 2.4V typical under voltage lockout (UVLO)
- 1ms turn-on (soft-start) and fast turn-off
- Enable active-high (H) or active-low (L)
- SOP-8L: Available in "Green" Molding Compound (No Br, Sb)
- Lead Free Finish/ RoHS Compliant (Note 1)

General Description

The AP1212 series are dual integrated high-side power switch with independent enable and flag functions, optimized for self-powered and bus-powered Universal Serial Bus (USB) applications. The AP1212 series support the following USB requirements: each switch channel supplies up to 500mA as required by USB downstream devices; the switch's low on-resistance meets USB voltage drop requirements; fault current is limited to typically 1000mA, well below the UL 25VA safety requirements; and a flag output is available to indicate fault conditions to the local USB controller. Soft start eliminates the momentary voltage drop on the upstream port that may occur when the switch is enabled in bus-powered applications. Additional features include thermal shutdown to prevent catastrophic switch failure from high-current loads, under voltage lockout (UVLO) to ensure that the device remains off unless there is a valid input voltage present, and 3.3V and 5V logic compatible enable inputs.

Applications

- USB hubs
- Hot plug-in power supplies
- Battery-charger circuits

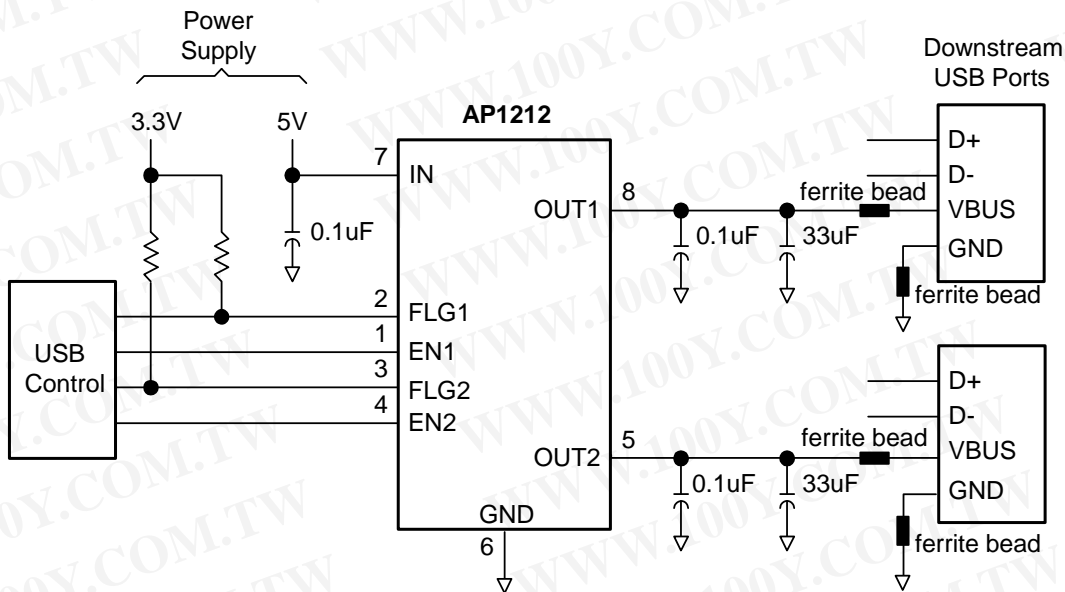

勝特力材料 886-3-5753170
 勝特力电子(上海) 86-21-34970699
 勝特力电子(深圳) 86-755-83298787
[Http://www.100y.com.tw](http://www.100y.com.tw)

Typical Application Circuit

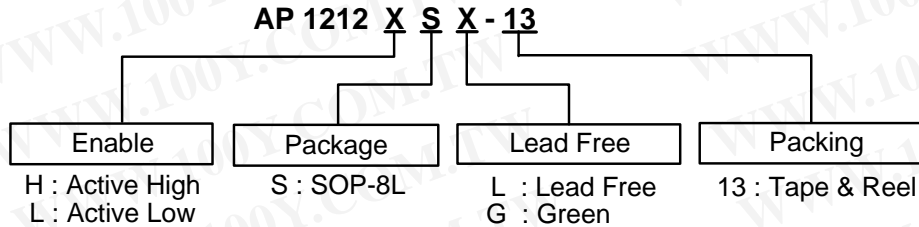

Ordering Information



Device	Package Code	Packaging (Note 2)	13" Tape and Reel	
			Quantity	Part Number Suffix
 AP1212XSL-13	S	SOP-8L	2500/Tape & Reel	-13
 AP1212XSG-13	S	SOP-8L	2500/Tape & Reel	-13

Notes: 1. EU Directive 2002/95/EC (RoHS). All applicable RoHS exemptions applied. Please visit our website at http://www.diodes.com/products/lead_free.html.
 2. Pad layout as shown on Diodes Inc. suggested pad layout document AP02001, which can be found on our website at <http://www.diodes.com/datasheets/ap02001.pdf>.

Pin Assignments

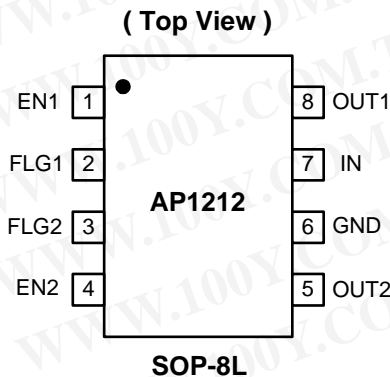

勝特力材料 886-3-5753170
 勝特力电子(上海) 86-21-34970699
 勝特力电子(深圳) 86-755-83298787
[Http://www.100y.com.tw](http://www.100y.com.tw)

Pin Descriptions

Pin Name	Description
EN1 EN2	Enable: Logic-compatible enable input. (H: active high, L: active low). Do not float.
FLG1 FLG2	Fault Flag: Active-low, open-drain output. Indicates over current, UVLO, and thermal shutdown.
GND	Supply return.
IN	Supply Input: Output MOSFET drain. Also supplies IC's internal circuitry. Connect to positive supply.
OUT1 OUT2	Switch Output: Output MOSFET source. Typically connect to switched side of load.

Block Diagram

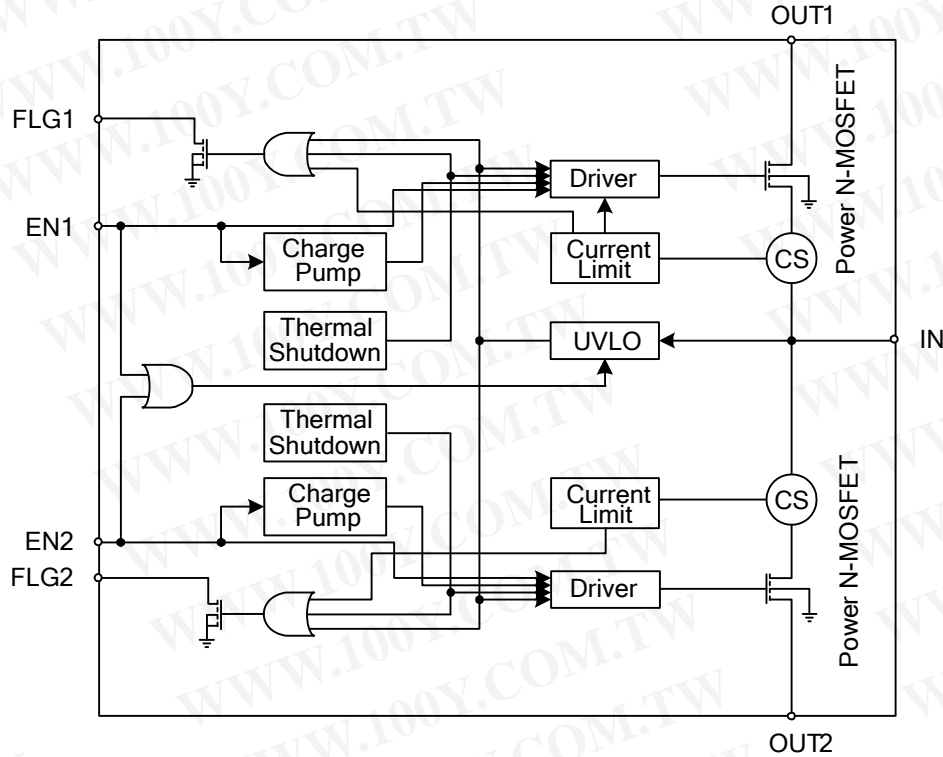

Test Circuit (Note 3)

勝特力材料 886-3-5753170
勝特力电子(上海) 86-21-34970699
勝特力电子(深圳) 86-755-83298787
[Http://www.100y.com.tw](http://www.100y.com.tw)

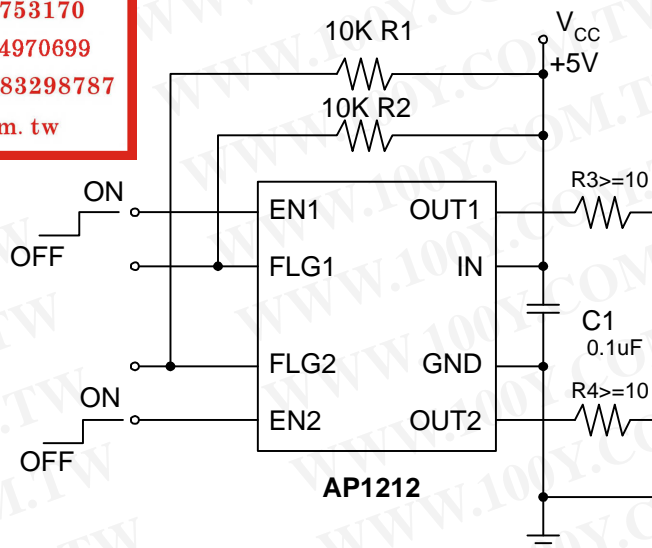

Notes: 3. Before EN is asserted, a delay of 10ms minimum from when the supply voltage, Vcc, becomes stable must be allowed.

Absolute Maximum Ratings (Note 4)

Symbol	Parameter	Rating	Unit
ESD HBM	Human Body Model ESD Protection (Note 5)	500	V
ESD MM	Machine Model ESD Protection (Note 5)	150	V
V_{IN}	Supply Voltage	+7	V
V_{FLG}	Fault Flag Voltage	+7	V
I_{FLG}	Fault Flag Current	50	mA
V_{OUT}	Output Voltage	+7	V
V_{EN}	Control Input Range	-0.3 to $V_{IN}+2$	V
T_{ST}	Storage Temperature	-65 to +150	°C
MSL	Moisture Sensitivity Level	3	-

Recommended Operating Conditions (Note 6)

Symbol	Parameter	Min	Max	Unit
V_{IN}	Supply Voltage	2.7	5.5	V
T_A	Operating Ambient Temperature	-40	125	°C

- Notes:
- Exceeding the absolute maximum rating may damage the device.
 - Devices are ESD sensitive. Handling precautions are recommended. Human Body model, tested per JEDEC 22-A114. Machine model, tested per JEDEC 22-A115.
 - The device is not guaranteed to function outside its operating rating.

勝特力材料 886-3-5753170
 勝特力电子(上海) 86-21-34970699
 勝特力电子(深圳) 86-755-83298787
[Http://www.100y.com.tw](http://www.100y.com.tw)

Electrical Characteristics

(Under the conditions of $V_{IN}=+5V$ and $T_A=25^{\circ}C$, unless otherwise specified)

Symbol	Parameter	Conditions	Min	Typ.	Max	Unit
I_{CC}	Supply Current	Switch off, OUT = open (Note 7)		0.50	5	μA
		All switches on, OUT = open (Note 7)		110	160	μA
V_{IT}	Enable Input Threshold	(Note 7)	0.8	1.7	2.40	V
I_{EN}	Enable Input Current	$V_{EN} = 0V$ to 5.5V	-1	± 0.01	1	μA
C_{EN}	Enable Input Capacitance			1		pF
$R_{DS(ON)}$	Switch Resistance	$V_{IN} = 2.7V \sim 5.5V$, $I_{OUT} = 500mA$, each switch		110	140	m Ω
T_{OND}	Output Turn-On Delay	$R_L = 10\Omega$ each output		30		μS
T_R	Output Turn-On Rise Time	$R_L = 10\Omega$ each output		1		mS
T_{OFFD}	Output Turnoff Delay	$R_L = 10\Omega$ each output		0.5	10	μS
T_F	Output Turnoff Fall Time	$R_L = 10\Omega$ each output		0.5	10	μS
I_{LEAK}	Output Leakage Current	Each output (output disabled)			10	μA
I_{OUT}	Continuous Load Current	Each output	0.6			A
I_{OS}	Short-circuit Current Limit	Each output (enable into load), $V_{OUT} = 0V$	0.8	1.0	1.25	A
I_{LIM}	Current-Limit Threshold	Ramped load applied to enabled output	1.0	1.2	1.4	A
T_{TS}	Over-temperature Shutdown Threshold	T_J increasing		140		$^{\circ}C$
		T_J decreasing		130		$^{\circ}C$
R_{FO}	Error Flag Output Resistance	$V_{IN} = 5V$, $I_L = 10mA$		10	25	Ω
		$V_{IN} = 3.3V$, $I_L = 10mA$		15	40	Ω
I_{FOH}	Error Flag Off Current	$V_{FLAG} = 5V$		0.01	1	μA
UVLO	UVLO Threshold	$V_{IN} =$ increasing		2.5		V
		$V_{IN} =$ decreasing		2.3		V
θ_{JA}	Thermal Resistance Junction-to-Ambient	SOP-8L		165		$^{\circ}C/W$
θ_{JC}	Thermal Resistance Junction-to-Case	SOP-8L		26		$^{\circ}C/W$

Notes: 7. Off is $V_{EN} \leq 0.8V$ and on is $V_{EN} \geq 2.4V$ for the AP1212H. Off is $V_{EN} \geq 2.4V$ and on is $V_{EN} \leq 0.8V$ for the AP1212L.

勝特力材料 886-3-5753170
 勝特力电子(上海) 86-21-34970699
 勝特力电子(深圳) 86-755-83298787
[Http://www.100y.com.tw](http://www.100y.com.tw)

Typical Performance Characteristics

On-Resistance vs. Supply Voltage

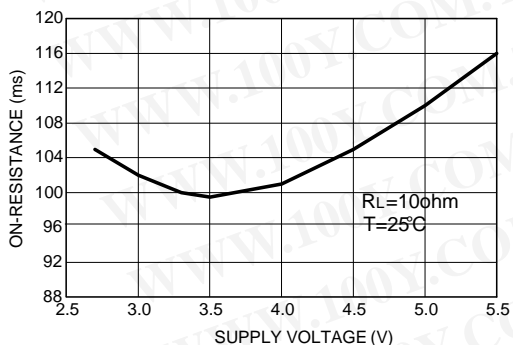

On-Resistance vs. Temperature

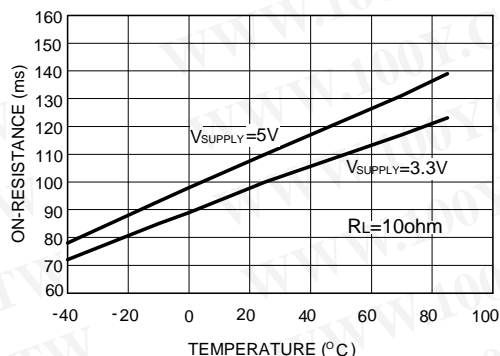

Turn-On Rise Time vs. Supply Voltage

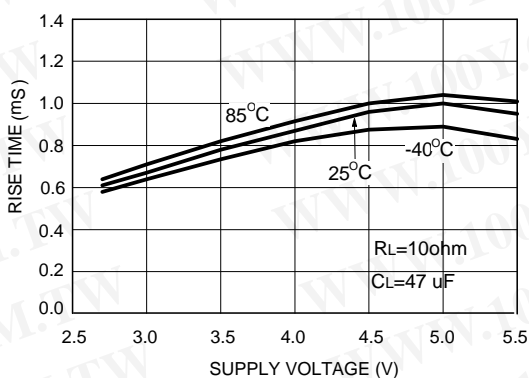

Turn-On Rise Time vs. Temperature

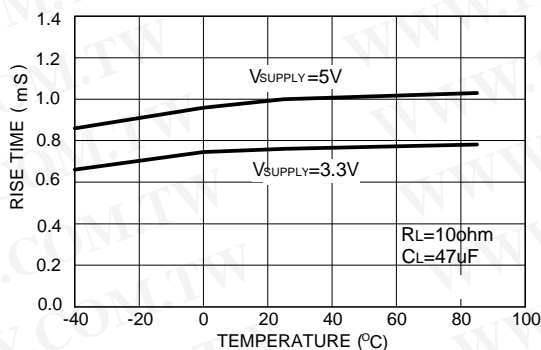

On-Current vs. Supply Voltage

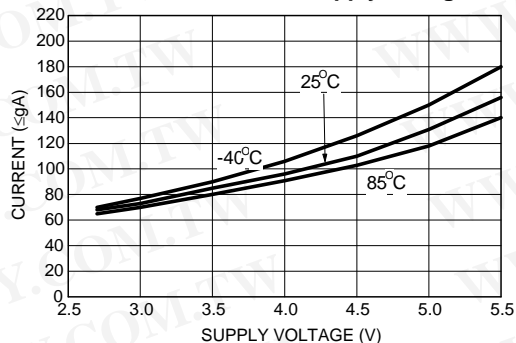

On-Current vs. Temperature

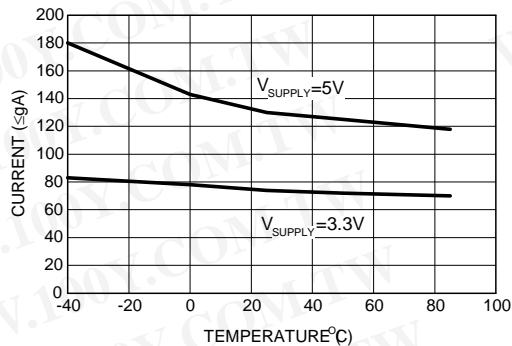

勝特力材料 886-3-5753170
 勝特力电子(上海) 86-21-34970699
 勝特力电子(深圳) 86-755-83298787
[Http://www.100y.com.tw](http://www.100y.com.tw)

Typical Performance Characteristics (Continued)

Off-Current vs. Supply Voltage

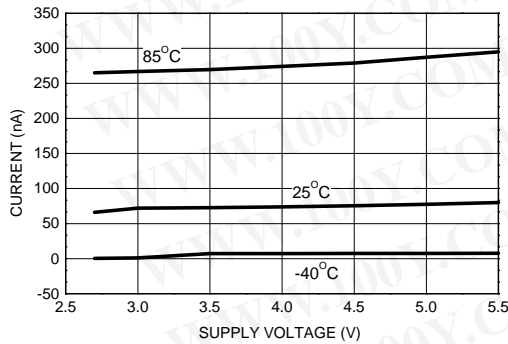

Off-Current vs. Temperature

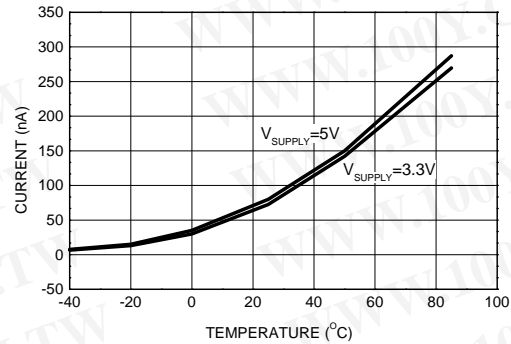

Enable Threshold vs. Supply Voltage

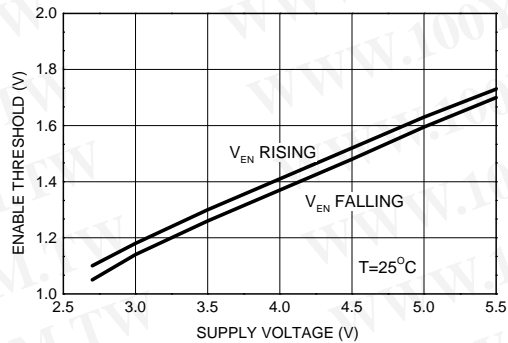

Enable Threshold vs. Temperature

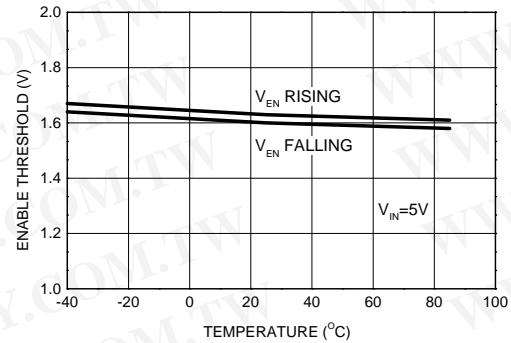

Short-Circuit Current-Limit vs. Supply Voltage

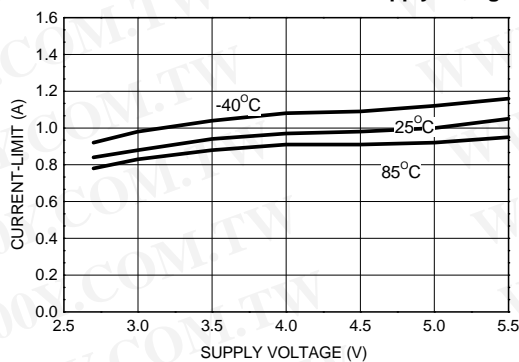

Short-Circuit Current-Limit vs. Temperature

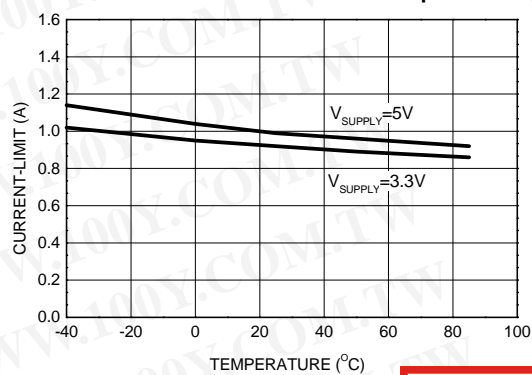

勝特力材料 886-3-5753170
 勝特力电子(上海) 86-21-34970699
 勝特力电子(深圳) 86-755-83298787
[Http://www.100y.com.tw](http://www.100y.com.tw)

Typical Performance Characteristics (Continued)

Current-Limit Threshold vs. Supply Voltage

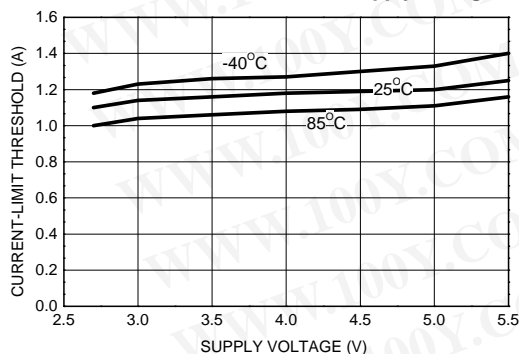

Current-Limit Threshold vs. Temperature

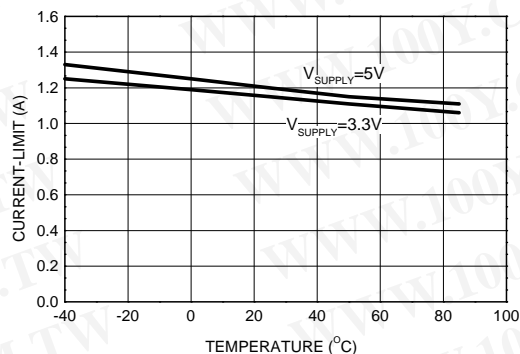

UVLO Threshold vs. Temperature

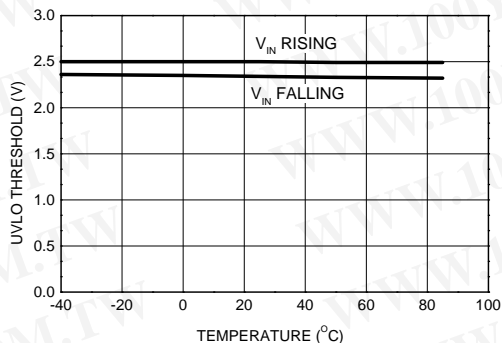

勝特力材料 886-3-5753170
 勝特力电子(上海) 86-21-34970699
 勝特力电子(深圳) 86-755-83298787
[Http://www.100y.com.tw](http://www.100y.com.tw)

Typical Performance Characteristics (Continued)

Turn-On/Turn-Off (AP1212H)

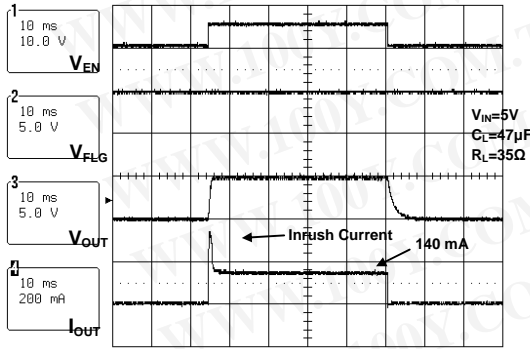

TIME (10mS/div.)

Turn-On (AP1212H)

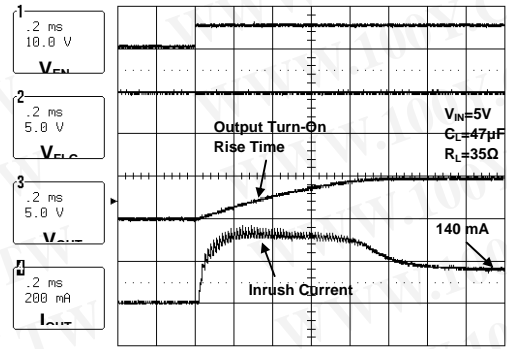

TIME (200µS/div.)

Turn-Off (AP1212H)

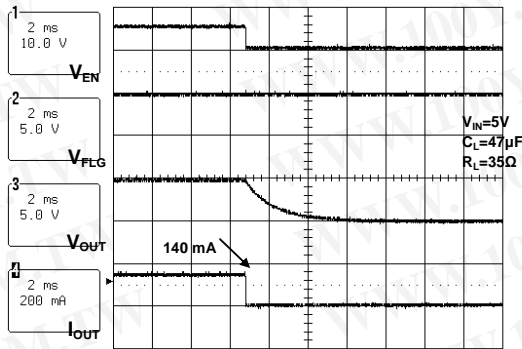

TIME (2mS/div.)

Enabled Into Short (AP1212H)

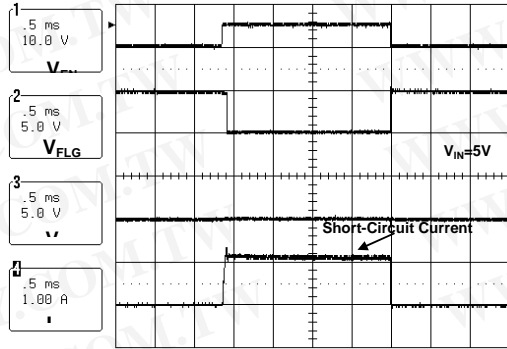

TIME (500µS/div.)

Current-Limit Response (AP1212H)

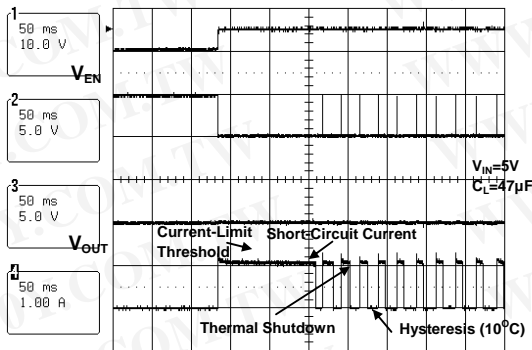

TIME (50mS/div.)

Current-Limit Response (AP1212H)

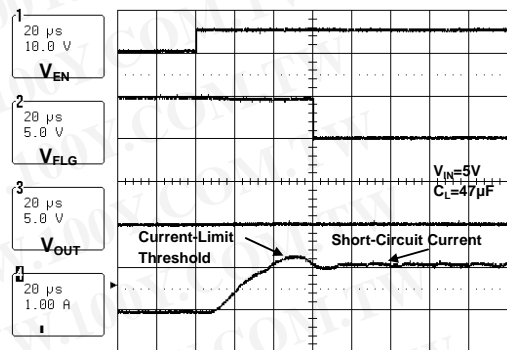

TIME (20µS/div.)

勝特力材料 886-3-5753170
 勝特力电子(上海) 86-21-34970699
 勝特力电子(深圳) 86-755-83298787
[Http://www.100y.com.tw](http://www.100y.com.tw)

Functional Description

Error Flag

An open-drained output of N-channel MOSFET, the FLG output is pulled low to signal the following fault conditions: input under voltage, output current limit, and thermal shutdown.

Current Limit

The current limit threshold is preset internally. It protects the output MOSFET switches from damage due to undesirable short circuit conditions or excess inrush current often encountered during hot plug-in. The low limit of the current limit threshold of the AP1212 allows a minimum current of 0.5A through the MOSFET switches. A current limit condition will signal the error flag.

Thermal Shutdown

When the chip temperature exceeds 140°C for any reason other than over current fault of either one of the two MOSFET switches, the thermal shutdown function turns off both MOSFET switches and signals the error flag. A hysteresis of 10°C prevents the MOSFETs from turning back on until the chip temperature drops to below 130°C.

Enable

Before EN is asserted, a delay of 10ms minimum from when the supply voltage, Vcc, becomes stable must be allowed.

Supply Filtering

A 0.1µF to 1µF bypass capacitor from IN to GND, located near the device, is strongly recommended to control supply transients. Without a bypass capacitor, an output short may cause sufficient ringing on the input (from supply lead inductance) to damage internal control circuitry.

Transient Droop Requirements

USB applications support dynamic attachment (hot plug-in) of peripherals. A current surge is caused by the input capacitance of downstream device. Ferrite beads are recommended in series with all power and ground connector pins. Ferrite beads reduce EMI and limit the inrush current during hot-attachment by filtering high-frequency signals.

Short Circuit Transient

Bulk capacitance provides the short-term transient current needed during a hot-attachment event. With a 33µF, 16V tantalum or 100µF, 10V electrolytic capacitor mounted close to downstream connector per port should provide transient drop protection.

Printed Circuit Layout

The power circuitry of USB printed circuit boards requires a customized layout to maximize thermal dissipation and to minimize voltage drop and EMI.

勝特力材料 886-3-5753170
勝特力电子(上海) 86-21-34970699
勝特力电子(深圳) 86-755-83298787
[Http://www.100y.com.tw](http://www.100y.com.tw)

Marking Information

(1) SOP-8L

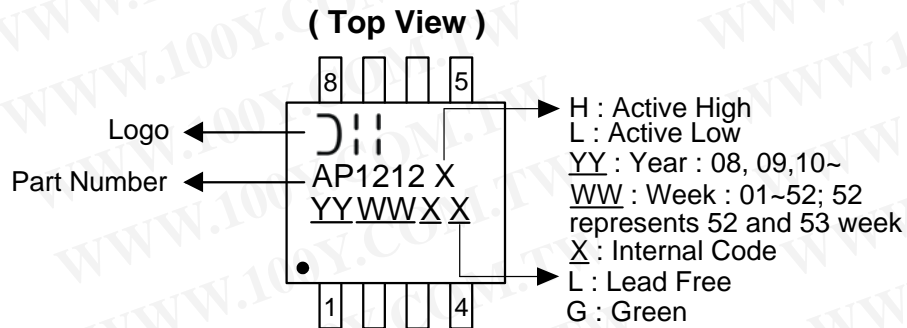

Package Information (All Dimensions in mm)

(1) Package Type: SOP-8L

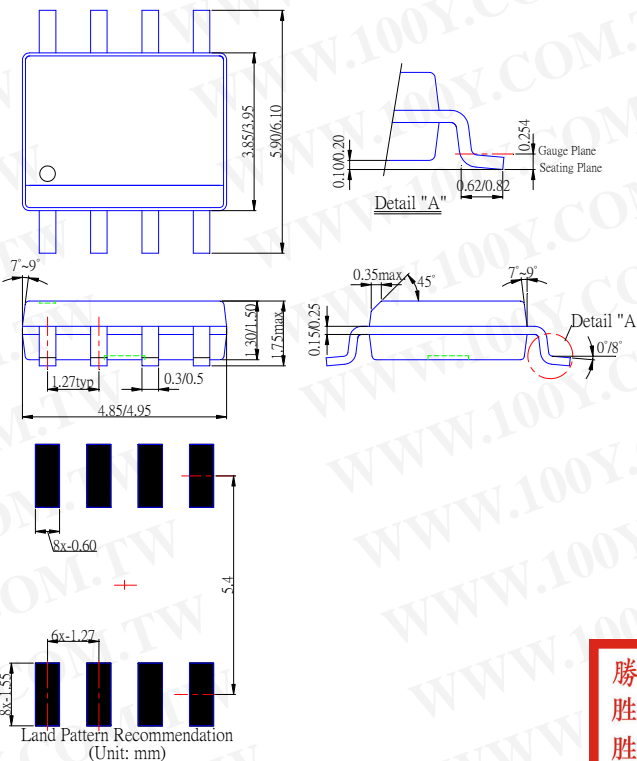

勝特力材料 886-3-5753170
 勝特力电子(上海) 86-21-34970699
 勝特力电子(深圳) 86-755-83298787
[Http://www.100y.com.tw](http://www.100y.com.tw)

IMPORTANT NOTICE

DIODES INCORPORATED MAKES NO WARRANTY OF ANY KIND, EXPRESS OR IMPLIED, WITH REGARDS TO THIS DOCUMENT, INCLUDING, BUT NOT LIMITED TO, THE IMPLIED WARRANTIES OF MERCHANTABILITY AND FITNESS FOR A PARTICULAR PURPOSE (AND THEIR EQUIVALENTS UNDER THE LAWS OF ANY JURISDICTION).

Diodes Incorporated and its subsidiaries reserve the right to make modifications, enhancements, improvements, corrections or other changes without further notice to this document and any product described herein. Diodes Incorporated does not assume any liability arising out of the application or use of this document or any product described herein; neither does Diodes Incorporated convey any license under its patent or trademark rights, nor the rights of others. Any Customer or user of this document or products described herein in such applications shall assume all risks of such use and will agree to hold Diodes Incorporated and all the companies whose products are represented on Diodes Incorporated website, harmless against all damages.

Diodes Incorporated does not warrant or accept any liability whatsoever in respect of any products purchased through unauthorized sales channel.

Should Customers purchase or use Diodes Incorporated products for any unintended or unauthorized application, Customers shall indemnify and hold Diodes Incorporated and its representatives harmless against all claims, damages, expenses, and attorney fees arising out of, directly or indirectly, any claim of personal injury or death associated with such unintended or unauthorized application.

Products described herein may be covered by one or more United States, international or foreign patents pending. Product names and markings noted herein may also be covered by one or more United States, international or foreign trademarks.

LIFE SUPPORT

Diodes Incorporated products are specifically not authorized for use as critical components in life support devices or systems without the express written approval of the Chief Executive Officer of Diodes Incorporated. As used herein:

A. Life support devices or systems are devices or systems which:

1. are intended to implant into the body, or
2. support or sustain life and whose failure to perform when properly used in accordance with instructions for use provided in the labeling can be reasonably expected to result in significant injury to the user.

B. A critical component is any component in a life support device or system whose failure to perform can be reasonably expected to cause the failure of the life support device or to affect its safety or effectiveness.

Customers represent that they have all necessary expertise in the safety and regulatory ramifications of their life support devices or systems, and acknowledge and agree that they are solely responsible for all legal, regulatory and safety-related requirements concerning their products and any use of Diodes Incorporated products in such safety-critical, life support devices or systems, notwithstanding any devices- or systems-related information or support that may be provided by Diodes Incorporated. Further, Customers must fully indemnify Diodes Incorporated and its representatives against any damages arising out of the use of Diodes Incorporated products in such safety-critical, life support devices or systems.

Copyright © 2009, Diodes Incorporated

www.diodes.com

勝特力材料 886-3-5753170
勝特力电子(上海) 86-21-34970699
勝特力电子(深圳) 86-755-83298787
[Http://www.100y.com.tw](http://www.100y.com.tw)