

## 8M x 16 DDR Synchronous DRAM (SDRAM)

(Rev. 1.4 May/2006)

### Features

- Fast clock rate: 300/275/250/200MHz
- Differential Clock CK & /CK
- Bi-directional DQS
- DLL enable/disable by EMRS
- Fully synchronous operation
- Internal pipeline architecture
- Four internal banks, 1M x 16-bit for each bank
- Programmable Mode and Extended Mode registers
  - /CAS Latency: 3, 4
  - Burst length: 2, 4, 8
  - Burst Type: Sequential & Interleaved
- Individual byte write mask control
- DM Write Latency = 0
- Auto Refresh and Self Refresh
- 4096 refresh cycles / 32ms
- Precharge & active power down
- Power supplies: VDD & VDDQ = 2.5V ± 5%
- Interface: SSTL\_2 I/O Interface
- Package: 66 Pin TSOP II, 0.65mm pin pitch
- Lead-free Package is available.

### Pin Assignment (Top View)

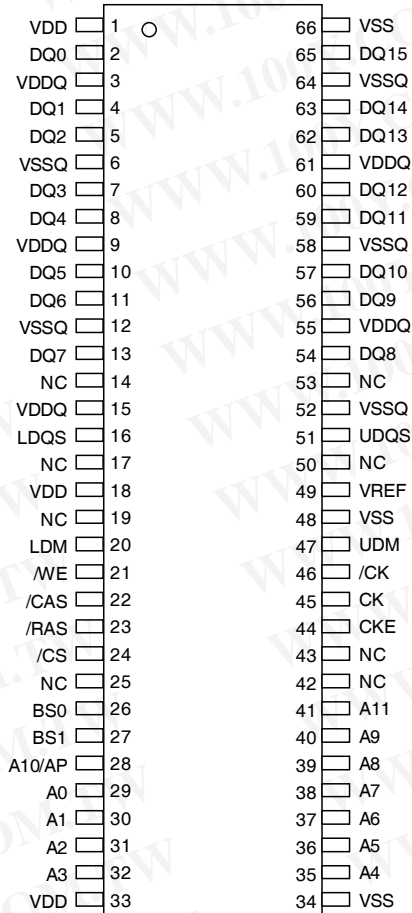

### Ordering Information

Part Number	Clock Frequency	Data Rate	Package
EM6A9160TS-3.3/3.3G*	300MHz	600Mbps/pin	TSOP II
EM6A9160TS-3.6/3.6G	275MHz	550Mbps/pin	TSOP II
EM6A9160TS-4/4G	250MHz	500Mbps/pin	TSOP II
EM6A9160TS-5/5G	200MHz	400Mbps/pin	TSOP II

Note : "G" indicates Pb-free package

勝特力材料 886-3-5753170  
 勝特力电子(上海) 86-21-34970699  
 勝特力电子(深圳) 86-755-83298787  
[Http://www.100y.com.tw](http://www.100y.com.tw)

### Etron Technology, Inc.

No. 6, Technology Rd. V, Science-Based Industrial Park, Hsinchu, Taiwan 30077, R.O.C.  
 TEL: (886)-3-5782345 FAX: (886)-3-5778671

Etron Technology, Inc., reserves the right to make changes to its products and specifications without notice.

### Overview

The EM6A9160 SDRAM is a high-speed CMOS double data rate synchronous DRAM containing 128 Mbits. It is internally configured as a quad 2M x 16 DRAM with a synchronous interface (all signals are registered on the positive edge of the clock signal, CK). Data outputs occur at both rising edges of CK and /CK. Read and write accesses to the SDRAM are burst oriented; accesses start at a selected location and continue for a programmed number of locations in a programmed sequence. Accesses begin with the registration of a BankActivate command which is then followed by a Read or Write command. The EM6A9160 provides programmable Read or Write burst lengths of 2, 4, or 8. An auto precharge function may be enabled to provide a self-timed row precharge that is initiated at the end of the burst sequence. The refresh functions, either Auto or Self Refresh are easy to use. In addition, EM6A9160 features programmable DLL option. By having a programmable mode register and extended mode register, the system can choose the most suitable modes to maximize its performance. These devices are well suited for applications requiring high memory bandwidth, result in a device particularly well suited to high performance main memory and graphics applications.

勝特力材料 886-3-5753170  
勝特力电子(上海) 86-21-34970699  
勝特力电子(深圳) 86-755-83298787  
[Http://www.100y.com.tw](http://www.100y.com.tw)

### Block Diagram

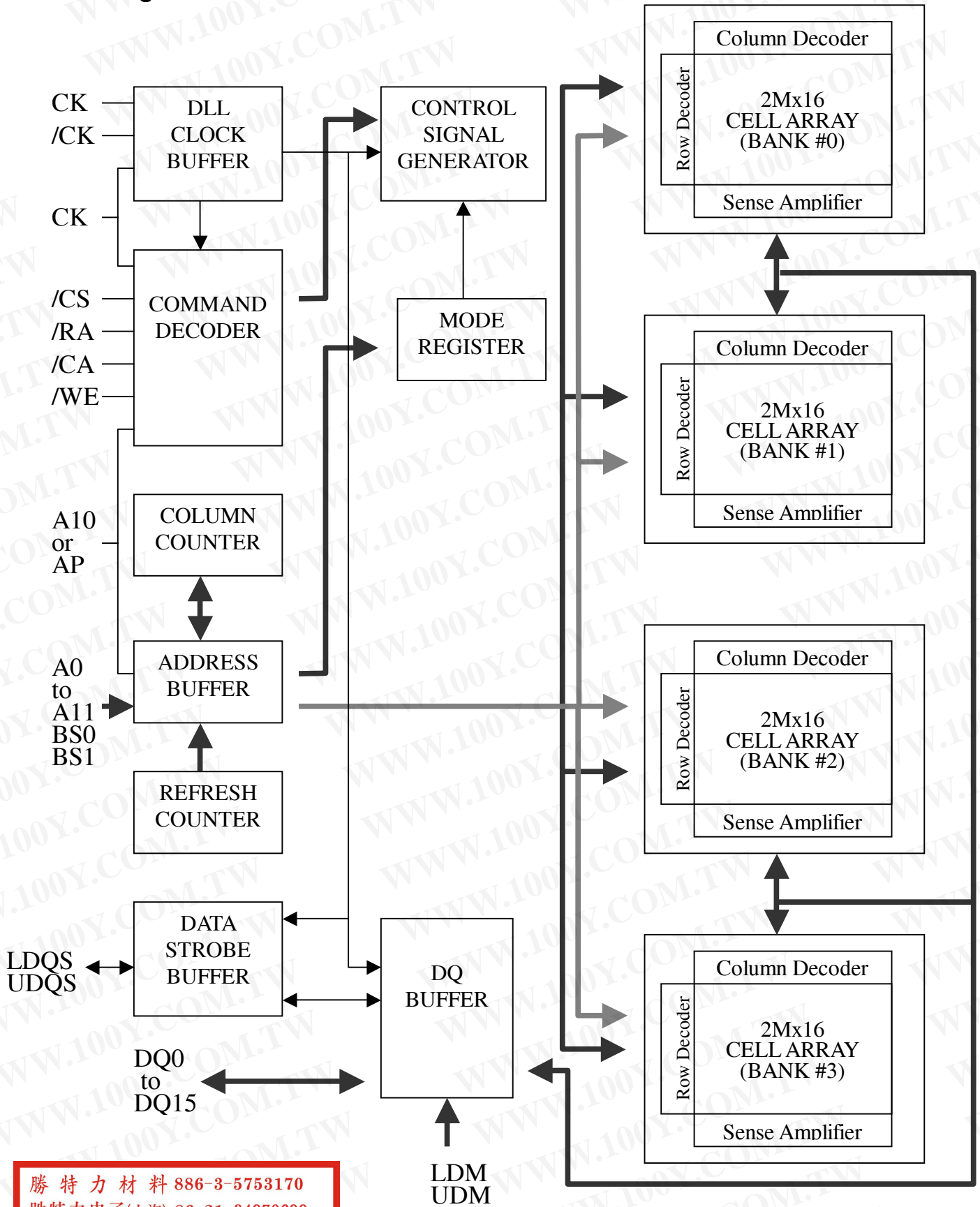

勝特力材料 886-3-5753170  
勝特力电子(上海) 86-21-34970699  
勝特力电子(深圳) 86-755-83298787  
[Http://www.100y.com.tw](http://www.100y.com.tw)

## Pin Descriptions

Table 1. Pin Details of EM6A9160

Symbol	Type	Description
CK, /CK	Input	<b>Differential Clock:</b> CK, /CK are driven by the system clock. All SDRAM input signals are sampled on the positive edge of CK. Both CK and /CK increment the internal burst counter and controls the output registers.
CKE	Input	<b>Clock Enable:</b> CKE activates(HIGH) and deactivates(LOW) the CK signal. If CKE goes low synchronously with clock, the internal clock is suspended from the next clock cycle and the state of output and burst address is frozen as long as the CKE remains low. When all banks are in the idle state, deactivating the clock controls the entry to the Power Down and Self Refresh modes.
BS0, BS1	Input	<b>Bank Select:</b> BS0 and BS1 defines to which bank the BankActivate, Read, Write, or BankPrecharge command is being applied.
A0-A11	Input	<b>Address Inputs:</b> A0-A11 are sampled during the BankActivate command (row address A0-A11) and Read/Write command (column address A0-A8 with A10 defining Auto Precharge).
/CS	Input	<b>Chip Select:</b> /CS enables (sampled LOW) and disables (sampled HIGH) the command decoder. All commands are masked when /CS is sampled HIGH. /CS provides for external bank selection on systems with multiple banks. It is considered part of the command code.
/RAS	Input	<b>Row Address Strobe:</b> The /RAS signal defines the operation commands in conjunction with the /CAS and /WE signals and is latched at the positive edges of CK. When /RAS and /CS are asserted "LOW" and /CAS is asserted "HIGH," either the BankActivate command or the Precharge command is selected by the /WE signal. When the /WE is asserted "HIGH," the BankActivate command is selected and the bank designated by BS is turned on to the active state. When the /WE is asserted "LOW," the Precharge command is selected and the bank designated by BS is switched to the idle state after the precharge operation.
/CAS	Input	<b>Column Address Strobe:</b> The /CAS signal defines the operation commands in conjunction with the /RAS and /WE signals and is latched at the positive edges of CK. When /RAS is held "HIGH" and /CS is asserted "LOW," the column access is started by asserting /CAS "LOW." Then, the Read or Write command is selected by asserting /WE "HIGH" or "LOW."
/WE	Input	<b>Write Enable:</b> The /WE signal defines the operation commands in conjunction with the /RAS and /CAS signals and is latched at the positive edges of CK. The /WE input is used to select the BankActivate or Precharge command and Read or Write command.
LDQS, UDQS	Input / Output	<b>Bidirectional Data Strobe:</b> Specifies timing for Input and Output data. Read Data Strobe is edge triggered. Write Data Strobe provides a setup and hold time for data and DQM. LDQS is for DQ0~7, UDQS is for DQ8~15.
LDM, UDM	Input	<b>Data Input Mask:</b> Input data is masked when DM is sampled HIGH during a write cycle. LDM masks DQ0-DQ7, UDM masks DQ8-DQ15.
DQ0 - DQ15	Input / Output	<b>Data I/O:</b> The DQ0-DQ15 input and output data are synchronized with the positive edges of CK and /CK. The I/Os are byte-maskable during Writes.

V <sub>DD</sub>	Supply	<b>Power Supply:</b> +2.5V ±5%
V <sub>SS</sub>	Supply	<b>Ground</b>
V <sub>DDQ</sub>	Supply	<b>DQ Power:</b> +2.5V ±5%. Provide isolated power to DQs for improved noise immunity.
V <sub>SSQ</sub>	Supply	<b>DQ Ground:</b> Provide isolated ground to DQs for improved noise immunity.
V <sub>REF</sub>	Supply	<b>Reference Voltage for Inputs:</b> +0.5*V <sub>DDQ</sub>
NC	-	<b>No Connect:</b> These pins should be left unconnected.

勝特力材料 886-3-5753170  
勝特力电子(上海) 86-21-34970699  
勝特力电子(深圳) 86-755-83298787  
[Http://www.100y.com.tw](http://www.100y.com.tw)

### Operation Mode

Fully synchronous operations are performed to latch the commands at the positive edges of CK. Table 2 shows the truth table for the operation commands.

**Table 2. Truth Table (Note (1), (2) )**

Command	State	CKE <sub>n-1</sub>	CKE <sub>n</sub>	UDM	UDM	BS0,1	A10	A0-9,11	/CS	/RAS	/CAS	/WE
BankActivate	Idle <sup>(3)</sup>	H	X	X	X	V	Row address		L	L	H	H
BankPrecharge	Any	H	X	X	X	V	L	X	L	L	H	L
PrechargeAll	Any	H	X	X	X	X	H	X	L	L	H	L
Write	Active <sup>(3)</sup>	H	X	X	X	V	L	Column address (A0 ~ A8)	L	H	L	L
Write and AutoPrecharge	Active <sup>(3)</sup>	H	X	X	X	V	H		L	H	L	L
Read	Active <sup>(3)</sup>	H	X	X	X	V	L	Column address (A0 ~ A8)	L	H	L	H
Read and Autoprecharge	Active <sup>(3)</sup>	H	X	X	X	V	H		L	H	L	H
Mode Register Set	Idle	H	X	X	X	OP code			L	L	L	L
Extended MRS	Idle	H	X	X	X	OP code			L	L	L	L
No-Operation	Any	H	X	X	X	X	X	X	L	H	H	H
Burst Stop	Active <sup>(4)</sup>	H	X	X	X	X	X	X	L	H	H	L
Device Deselect	Any	H	X	X	X	X	X	X	H	X	X	X
AutoRefresh	Idle	H	H	X	X	X	X	X	L	L	L	H
SelfRefresh Entry	Idle	H	L	X	X	X	X	X	L	L	L	H
SelfRefresh Exit	Idle (SelfRefresh)	L	H	X	X	X	X	X	H	X	X	X
									L	H	H	H
Precharge Power Down Mode Entry	Idle	H	L	X	X	X	X	X	H	X	X	X
									L	H	H	H
Precharge Power Down Mode Exit	Any (PowerDown)	L	H	X	X	X	X	X	H	X	X	X
									L	H	H	H
Active Power Down Mode Entry	Active	H	L	X	X	X	X	X	H	X	X	X
									L	V	V	V
Active Power Down Mode Exit	Any (PowerDown)	L	H	X	X	X	X	X	H	X	X	X
									L	H	H	H
Data Input Mask Disable	Active	H	X	L	L	X	X	X	X	X	X	X
Data Input Mask Enable <sup>(5)</sup>	Active	H	X	H	H	X	X	X	X	X	X	X

- Note:**
1. V=Valid data, X=Don't Care, L=Low level, H=High level
  2. CKE<sub>n</sub> signal is input level when commands are provided.  
CKE<sub>n-1</sub> signal is input level one clock cycle before the commands are provided.
  3. These are states of bank designated by BS signal.
  4. Device state is 1, 2, 4, 8, and full page burst operation.
  5. LDM and UDM can be enable respectively.

勝特力材料 886-3-5753170  
 勝特力电子(上海) 86-21-34970699  
 勝特力电子(深圳) 86-755-83298787  
[Http://www.100y.com.tw](http://www.100y.com.tw)

### Mode Register Set (MRS)

The mode register is divided into various fields depending on functionality.

- Burst Length Field (A2~A0)

This field specifies the data length of column access using the A2~A0 pins and selects the Burst Length to be 2, 4, 8.

A2	A1	A0	Burst Length
0	0	0	Reserved
0	0	1	2
0	1	0	4
0	1	1	8
1	0	0	Reserved
1	0	1	Reserved
1	1	0	Reserved
1	1	1	Reserved

勝特力材料 886-3-5753170  
 勝特力电子(上海) 86-21-34970699  
 勝特力电子(深圳) 86-755-83298787  
[Http://www.100y.com.tw](http://www.100y.com.tw)

- Addressing Mode Select Field (A3)

The Addressing Mode can be one of two modes, both Interleave Mode or Sequential Mode. Both Sequential Mode and Interleave Mode support burst length of 2,4 and 8.

A3	Addressing Mode
0	Sequential
1	Interleave

--- Addressing Sequence of Sequential Mode

An internal column address is performed by increasing the address from the column address which is input to the device. The internal column address is varied by the Burst Length as shown in the following table.

Data n	0	1	2	3	4	5	6	7
Column Address	n	n+1	n+2	n+3	n+4	n+5	n+6	n+7
Burst Length	2 words							
	4 words							
	8 words							
	Full Page (Even starting address)							

--- Addressing Sequence of Interleave Mode

A column access is started in the input column address and is performed by inverting the address bits in the sequence shown in the following table.

Data n	Column Address								Burst Length	
Data 0	A7	A6	A5	A4	A3	A2	A1	A0	4 words	8 words
Data 1	A7	A6	A5	A4	A3	A2	A1	A0#		
Data 2	A7	A6	A5	A4	A3	A2	A1#	A0		
Data 3	A7	A6	A5	A4	A3	A2	A1#	A0#		
Data 4	A7	A6	A5	A4	A3	A2#	A1	A0		
Data 5	A7	A6	A5	A4	A3	A2#	A1	A0#		
Data 6	A7	A6	A5	A4	A3	A2#	A1#	A0		
Data 7	A7	A6	A5	A4	A3	A2#	A1#	A0#		

- CAS Latency Field (A6~A4)

This field specifies the number of clock cycles from the assertion of the Read command to the first read data. The minimum whole value of CAS Latency depends on the frequency of CK. The minimum whole value satisfying the following formula must be programmed into this field.  $t_{CAC}(\min) \leq \text{CAS Latency} \times t_{CK}$

A6	A5	A4	CAS Latency
0	0	0	Reserved
0	0	1	Reserved
0	1	0	Reserved
0	1	1	3 clocks
1	0	0	4 clocks
1	0	1	Reserved
1	1	0	Reserved
1	1	1	Reserved

- Test Mode field (A8~A7)

These two bits are used to enter the test mode and must be programmed to "00" in normal operation.

A8	A7	Test Mode
0	0	Normal mode
1	0	DLL Reset
X	1	Test mode

- (BS0, BS1)

BS1	BS0	An ~ A0
RFU	0	MRS Cycle
RFU	1	Extended Functions (EMRS)

勝特力材料 886-3-5753170  
勝特力电子(上海) 86-21-34970699  
勝特力电子(深圳) 86-755-83298787  
[Http://www.100y.com.tw](http://www.100y.com.tw)

### Extended Mode Register Set (EMRS)

The Extended Mode Register Set stores the data for enabling or disabling DLL and selecting output driver strength. The default value of the extended mode register is not defined, therefore must be written after power up for proper operation. The extended mode register is written by asserting low on CS#, RAS#, CAS#, and WE#. The state of A0, A2 ~ A5, A7 ~ A11 and BS1 is written in the mode register in the same cycle as CS#, RAS#, CAS#, and WE# going low. The DDR SDRAM should be in all bank precharge with CKE already high prior to writing into the extended mode register. A1 and A6 are used for setting driver strength to normal, weak or matched impedance. Two clock cycles are required to complete the write operation in the extended mode register. The mode register contents can be changed using the same command and clock cycle requirements during operation as long as all banks are in the idle state. A0 is used for DLL enable or disable. "High" on BS0 is used for EMRS. Refer to the table for specific codes.

### Extended Mode Resistor Bitmap

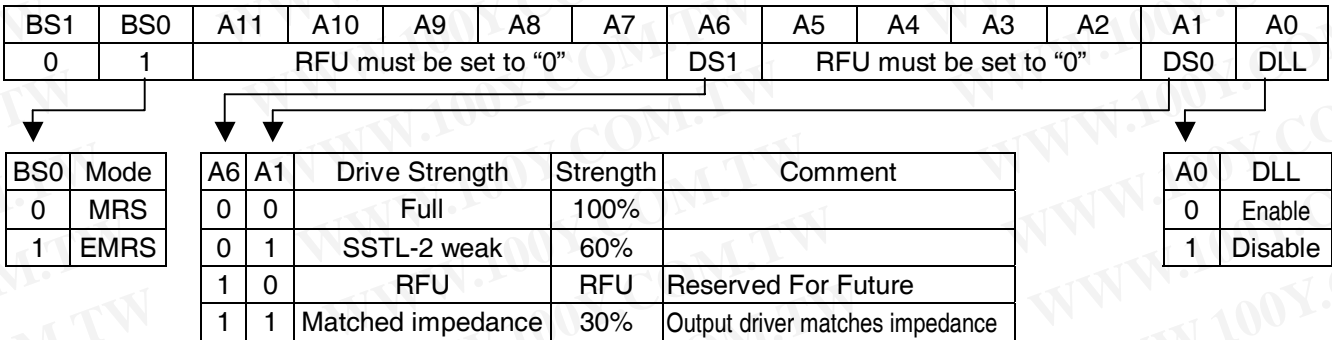

勝特力材料 886-3-5753170  
 勝特力电子(上海) 86-21-34970699  
 勝特力电子(深圳) 86-755-83298787  
[Http://www.100y.com.tw](http://www.100y.com.tw)

### Absolute Maximum Rating

Symbol	Item	Rating		Unit	Note
		-3.3/3.6/4/5	-3.3G/3.6G/4G/5G		
V <sub>IN</sub> , V <sub>OUT</sub>	Input, Output Voltage	- 0.3~ V <sub>DD</sub> + 0.3		V	1
V <sub>DD</sub> , V <sub>DDQ</sub>	Power Supply Voltage	- 0.3~3.6		V	1
T <sub>OPR</sub>	Operating Temperature	0~70		°C	1
T <sub>STG</sub>	Storage Temperature	- 55~150		°C	1
T <sub>SOLDER</sub>	Soldering Temperature	245	260	°C	1
P <sub>D</sub>	Power Dissipation	1		W	1
I <sub>OUT</sub>	Short Circuit Output Current	50		mA	1

### Recommended D.C. Operating Conditions (Ta = 0 ~ 70 °C)

Parameter	Symbol	Min.	Max.	Unit	Note
Power Supply Voltage	V <sub>DD</sub>	2.375	2.625	V	
Power Supply Voltage (for I/O Buffer)	V <sub>DDQ</sub>	2.375	2.625	V	
Input Reference Voltage	V <sub>REF</sub>	0.49* V <sub>DDQ</sub>	0.51* V <sub>DDQ</sub>	V	
Termination Voltage	V <sub>TT</sub>	V <sub>REF</sub> - 0.04	V <sub>REF</sub> + 0.04	V	
Input High Voltage (DC)	V <sub>IH</sub> (DC)	V <sub>REF</sub> + 0.15	V <sub>DDQ</sub> + 0.3	V	
Input Low Voltage (DC)	V <sub>IL</sub> (DC)	-0.3	V <sub>REF</sub> - 0.15	V	
Input Voltage Level, CLK and CLK# inputs	V <sub>IN</sub> (DC)	-0.3	V <sub>DDQ</sub> + 0.3	V	
Input leakage current	I <sub>I</sub>	-5	5	μA	
Output leakage current	I <sub>OZ</sub>	-5	5	μA	
Output High Voltage	V <sub>OH</sub>	V <sub>TT</sub> + 0.76	-	V	I <sub>OH</sub> = -15.2 mA
Output Low Voltage	V <sub>OL</sub>		V <sub>TT</sub> - 0.76	V	I <sub>OL</sub> = +15.2 mA

勝特力材料 886-3-5753170  
 勝特力电子(上海) 86-21-34970699  
 勝特力电子(深圳) 86-755-83298787  
[Http://www.100y.com.tw](http://www.100y.com.tw)

**Capacitance (V<sub>DD</sub> = 2.5V, f = 1MHz, Ta = 25 °C)**

Symbol	Parameter	Min.	Max.	Unit
C <sub>IN</sub>	Input Capacitance (except for CK pin)	2.5	4	pF
	Input Capacitance (CK pin)	2.5	4	pF
C <sub>I/O</sub>	DQ, DQS, DM Capacitance	4	6.5	pF

Note: These parameters are periodically sampled and are not 100% tested.

勝特力材料 886-3-5753170  
勝特力电子(上海) 86-21-34970699  
勝特力电子(深圳) 86-755-83298787  
[Http://www.100y.com.tw](http://www.100y.com.tw)

### Recommended D.C. Operating Conditions ( $V_{DD} = 2.5V \pm 5\%$ , $T_a = 0\sim 70\text{ }^\circ\text{C}$ )

Parameter & Test Condition	Symbol	3.3	3.6	4	5	Unit	Notes
		Max					
<b>OPERATING CURRENT</b> : One bank; Active-Precharge; $t_{RC}=t_{RC}(\text{min})$ ; $t_{CK}=t_{CK}(\text{min})$ ; DQ,DM and DQS inputs changing once per clock cycle; Address and control inputs changing once every two clock cycles.	IDD0	200	180	160	140	mA	
<b>OPERATING CURRENT</b> : One bank; Active-Read-Precharge; BL=4; CL=4; $t_{RCDDR}=4*t_{CK}$ ; $t_{RC}=t_{RC}(\text{min})$ ; $t_{CK}=t_{CK}(\text{min})$ ; $I_{out}=0\text{mA}$ ; Address and control inputs changing once per clock cycle	IDD1	220	200	180	160	mA	
<b>PRECHARGE POWER-DOWN STANDBY CURRENT</b> : All banks idle; power-down mode; $t_{CK}=t_{CK}(\text{min})$ ; CKE=LOW	IDD2P	50	45	40	35	mA	
<b>IDLE STANDLY CURRENT</b> : CKE = HIGH; CS#=HIGH(DESELECT); All banks idle; $t_{CK}=t_{CK}(\text{min})$ ; Address and control inputs changing once per clock cycle; $V_{IN}=V_{REF}$ for DQ, DQS and DM	IDD2N	110	100	90	80	mA	
<b>ACTIVE POWER-DOWN STANDBY CURRENT</b> : one bank active; power-down mode; CKE=LOW; $t_{CK}=t_{CK}(\text{min})$	IDD3P	50	45	40	35	mA	
<b>ACTIVE STANDBY CURRENT</b> : CS#=HIGH;CKE=HIGH; one bank active ; $t_{RC}=t_{RC}(\text{max})$ ; $t_{CK}=t_{CK}(\text{min})$ ;Address and control inputs changing once per clock cycle; DQ,DQS,and DM inputs changing twice per clock cycle	IDD3N	120	110	100	90	mA	
<b>OPERATING CURRENT BURST READ</b> : BL=2; READS; Continuous burst; one bank active; Address and control inputs changing once per clock cycle; $t_{CK}=t_{CK}(\text{min})$ ; $I_{out}=0\text{mA}$ ;50% of data changing on every transfer	IDD4R	340	310	280	250	mA	
<b>OPERATING CURRENT BURST Write</b> : BL=2; WRITES; Continuous Burst ;one bank active; address and control inputs changing once per clock cycle; $t_{CK}=t_{CK}(\text{min})$ ; DQ,DQS,and DM changing twice per clock cycle; 50% of data changing on every transfer	IDD4W	280	260	240	220	mA	
<b>AUTO REFRESH CURRENT</b> : $t_{RC}=t_{RFC}(\text{min})$ ; $t_{CK}=t_{CK}(\text{min})$	IDD5	270	250	230	210	mA	
<b>SELF REFRESH CURRENT</b> : Self Refresh Mode ; CKE<=0.2V; $t_{CK}=t_{CK}(\text{min})$	IDD6	2	2	2	2	mA	
<b>BURST OPERATING CURRENT 4 bank operation</b> : Four bank interleaving READs; BL=4;with Auto Precharge; $t_{RC}=t_{RC}(\text{min})$ ; $t_{CK}=t_{CK}(\text{min})$ ; Address and control inputschang only during Active, READ , or WRITE command	IDD7	440	400	360	330	mA	

勝特力材料 886-3-5753170  
 勝特力电子(上海) 86-21-34970699  
 勝特力电子(深圳) 86-755-83298787  
[Http://www.100y.com.tw](http://www.100y.com.tw)

### Electrical AC Characteristics ( $V_{DD} = 2.5 \pm 5\%$ , $T_a = 0\sim 70^\circ\text{C}$ )

Symbol	Parameter	3.3		3.6		4.0		5.0		Unit	
		Min	Max	Min	Max	Min	Max	Min	Max		
t <sub>CK</sub>	Clock cycle time	CL = 3	-	-	3.6	10	4	10	5	10	ns
		CL = 4	3.3	10	-	-	-	-	-	-	
t <sub>CH</sub>	Clock high level width	0.45	0.55	0.45	0.55	0.45	0.55	0.45	0.55	t <sub>CK</sub>	
t <sub>CL</sub>	Clock low level width	0.45	0.55	0.45	0.55	0.45	0.55	0.45	0.55	t <sub>CK</sub>	
t <sub>DQ<sub>SCK</sub></sub>	DQS-out access time from CK,CK#	-0.6	0.6	-0.6	0.6	-0.6	0.6	-0.7	0.7	ns	
t <sub>AC</sub>	Output access time from CK,CK#	-0.6	0.6	-0.6	0.6	-0.6	0.6	-0.7	0.7	ns	
t <sub>DQ<sub>SQ</sub></sub>	DQS-DQ Skew	-	0.35	-	0.4	-	0.4	-	0.45	ns	
t <sub>RP<sub>RE</sub></sub>	Read preamble	0.9	1.1	0.9	1.1	0.9	1.1	0.9	1.1	t <sub>CK</sub>	
t <sub>RP<sub>ST</sub></sub>	Read postamble	0.4	0.6	0.4	0.6	0.4	0.6	0.4	0.6	t <sub>CK</sub>	
t <sub>DQ<sub>SS</sub></sub>	CK to valid DQS-in	0.85	1.15	0.85	1.15	0.85	1.15	0.85	1.15	t <sub>CK</sub>	
t <sub>WP<sub>RES</sub></sub>	DQS-in setup time	0	-	0	-	0	-	0	-	ns	
t <sub>WP<sub>REH</sub></sub>	DQS-in hold time	0.35	-	0.35	-	0.35	-	0.3	-	t <sub>CK</sub>	
t <sub>WP<sub>ST</sub></sub>	DQS write postamble	0.4	0.6	0.4	0.6	0.4	0.6	0.4	0.6	t <sub>CK</sub>	
t <sub>DQ<sub>SH</sub></sub>	DQS in high level pulse width	0.4	0.6	0.4	0.6	0.4	0.6	0.4	0.6	t <sub>CK</sub>	
t <sub>DQ<sub>SL</sub></sub>	DQS in low level pulse width	0.4	0.6	0.4	0.6	0.4	0.6	0.4	0.6	t <sub>CK</sub>	
t <sub>IS</sub>	Address and Control input setup time	0.9	-	0.9	-	0.9	-	1.0	-	ns	
t <sub>IH</sub>	Address and Control input hold time	0.9	-	0.9	-	0.9	-	1.0	-	ns	
t <sub>DS</sub>	DQ & DM setup time to DQS	0.35	-	0.4	-	0.4	-	0.45	-	ns	
t <sub>DH</sub>	DQ & DM hold time to DQS	0.35	-	0.4	-	0.4	-	0.45	-	ns	
t <sub>HP</sub>	Clock half period	t <sub>CLMIN</sub> or t <sub>CHMIN</sub>	-	t <sub>CLMIN</sub> or t <sub>CHMIN</sub>	-	t <sub>CLMIN</sub> or t <sub>CHMIN</sub>	-	t <sub>CLMIN</sub> or t <sub>CHMIN</sub>	-	ns	
t <sub>QH</sub>	Output DQS valid window	t <sub>HP</sub> - 0.35	-	t <sub>HP</sub> - 0.4	-	t <sub>HP</sub> - 0.4	-	t <sub>HP</sub> - 0.45	-	ns	
t <sub>RC</sub>	Row cycle time	15	-	15	-	13	-	12	-	t <sub>CK</sub>	
t <sub>RFC</sub>	Refresh row cycle time	17	-	17	-	15	-	14	-	t <sub>CK</sub>	
t <sub>RAS</sub>	Row active time	10	100K	10	100K	9	100K	8	100K	t <sub>CK</sub>	
t <sub>RC<sub>DRD</sub></sub>	RAS# to CAS# Delay in Read	5	-	5	-	4	-	4	-	t <sub>CK</sub>	
t <sub>RC<sub>DWR</sub></sub>	RAS# to CAS# Delay in Write	3	-	3	-	2	-	2	-	t <sub>CK</sub>	
t <sub>RP</sub>	Row precharge time	5	-	5	-	4	-	4	-	t <sub>CK</sub>	
t <sub>RRD</sub>	Row active to Row active delay	3	-	3	-	3	-	3	-	t <sub>CK</sub>	
t <sub>WR</sub>	Write recovery time	3	-	3	-	3	-	3	-	t <sub>CK</sub>	
t <sub>CDLR</sub>	Last data in to Read command	3	-	2	-	2	-	2	-	t <sub>CK</sub>	
t <sub>CCD</sub>	Col. Address to Col. Address delay	1	-	1	-	1	-	1	-	t <sub>CK</sub>	
t <sub>MRD</sub>	Mode register set cycle time	2	-	2	-	2	-	2	-	t <sub>CK</sub>	
t <sub>DAL</sub>	Auto precharge write recovery + Precharge	8	-	8	-	7	-	7	-	t <sub>CK</sub>	
t <sub>XSA</sub>	Self refresh exit to read command delay	200	-	200	-	200	-	200	-	t <sub>CK</sub>	
t <sub>PDEX</sub>	Power down exit time	t <sub>CK</sub> + t <sub>IS</sub>	-	t <sub>CK</sub> + t <sub>IS</sub>	-	t <sub>CK</sub> + t <sub>IS</sub>	-	t <sub>CK</sub> + t <sub>IS</sub>	-	ns	
t <sub>REF</sub>	Refresh interval time	-	7.8	-	7.8	-	7.8	-	7.8	us	

勝特力材料 886-3-5753170  
 勝特力电子(上海) 86-21-34970699  
 勝特力电子(深圳) 86-755-83298787  
[Http://www.100y.com.tw](http://www.100y.com.tw)

### Recommended A.C. Operating Conditions ( $V_{DD} = 2.5 \pm 5\%$ , $T_a = 0\sim 70\text{ }^\circ\text{C}$ )

Parameter	Symbol	Min.	Max.	Unit	Note
Input High Voltage (DC)	$V_{IH} (AC)$	$V_{REF} + 0.35$		V	
Input Low Voltage (DC)	$V_{IL} (AC)$		$V_{REF} - 0.35$	V	
Input Different Voltage, CLK and CLK# inputs	$V_{ID} (AC)$	0.7	$V_{DDQ} + 0.6$	V	
Input Crossing Point Voltage, CLK and CLK# inputs	$V_{IX} (AC)$	$0.5 * V_{DDQ} - 0.2$	$0.5 * V_{DDQ} + 0.2$	V	

#### Note:

1. Stress greater than those listed under "Absolute Maximum Ratings" may cause permanent damage to the device.
2. All voltages are referenced to  $V_{SS}$ .
3. These parameters depend on the cycle rate and these values are measured by the cycle rate under the minimum value of  $t_{CK}$  and  $t_{RC}$ . Input signals are changed one time during  $t_{CK}$ .
4. Power-up sequence is described in Note 6.
5. A.C. Test Conditions

### SSTL\_2 Interface

Reference Level of Output Signals ( $V_{RFE}$ )	$0.5 * V_{DDQ}$
Output Load	Reference to the Under Output Load (A)
Input Signal Levels	$V_{REF} + 0.35\text{ V} / V_{REF} - 0.35\text{ V}$
Input Signals Slew Rate	1 V/ns
Reference Level of Input Signals	$0.5 * V_{DDQ}$

勝特力材料 886-3-5753170  
 勝特力电子(上海) 86-21-34970699  
 勝特力电子(深圳) 86-755-83298787  
[Http://www.100y.com.tw](http://www.100y.com.tw)

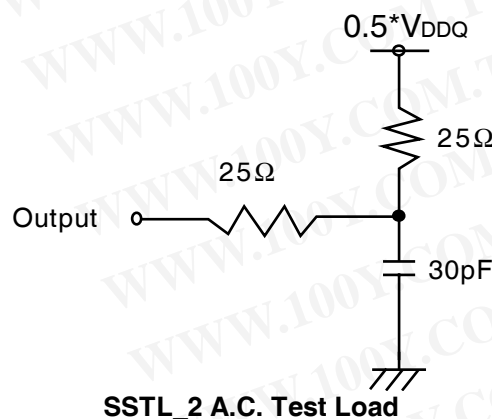

#### 6. Power up Sequence

Power up must be performed in the following sequence.

- 1) Power must be applied to  $V_{DD}$  and  $V_{DDQ}$ (simultaneously) when all input signals are held "NOP" state and maintain CKE "LOW". Power applied to  $V_{DDQ}$  the same time as  $V_{TT}$  and  $V_{REF}$ .

- 2) After power-up, No-Operation of 200  $\mu$ -seconds minimum is required.
- 3) Start clock and keep CKE "HIGH" to maintain either No-Operation or Device Deselect at the input.
- 4) Issue EMRS – enable DLL.
- 5) Issue MRS – reset DLL and set device to idle with bit A8 (An additional 200 cycles min of clock are needed for DLL lock)
- 6) Precharge all banks of the device.
- 7) Two or more Auto Refresh commands.
- 8) Issue MRS – Initialize device operation.

勝特力材料 886-3-5753170  
勝特力电子(上海) 86-21-34970699  
勝特力电子(深圳) 86-755-83298787  
[Http://www.100y.com.tw](http://www.100y.com.tw)

### Timing Waveforms

Figure 1. AC Parameters for Write Timing (Burst Length=4)

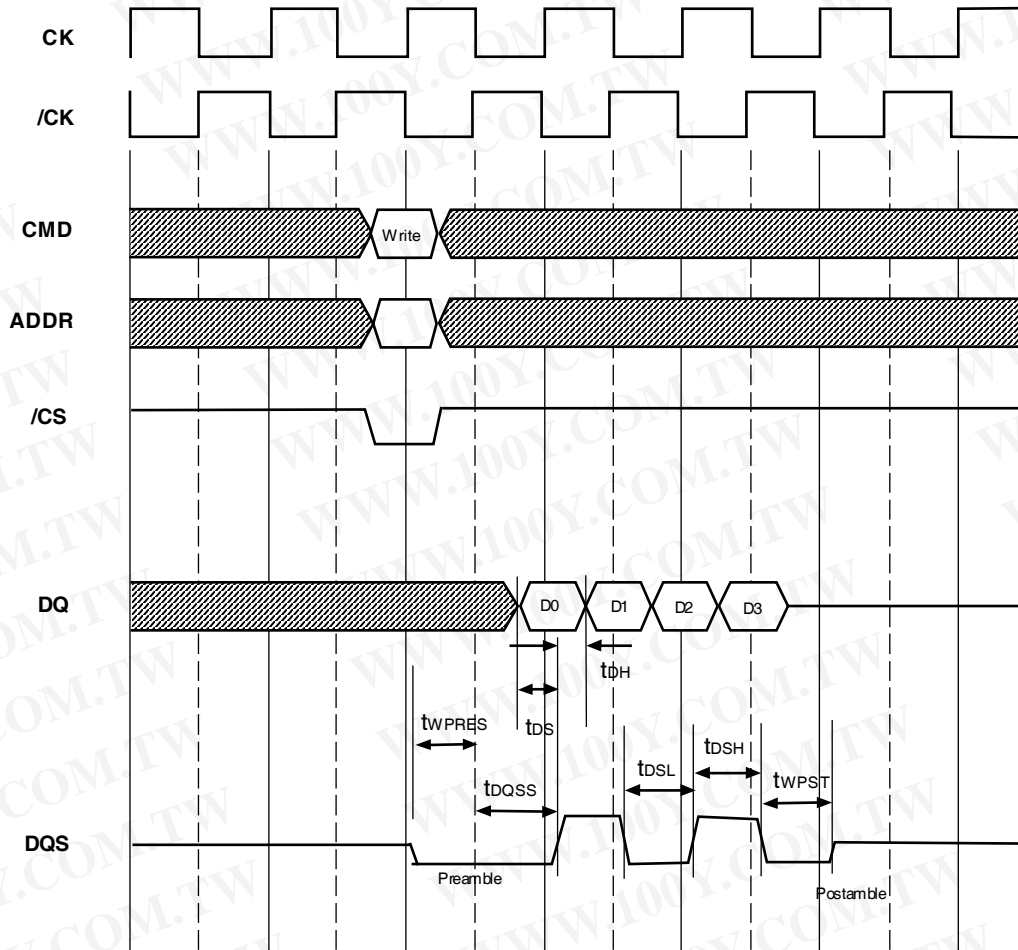

勝特力材料 886-3-5753170  
勝特力电子(上海) 86-21-34970699  
勝特力电子(深圳) 86-755-83298787  
[Http://www.100y.com.tw](http://www.100y.com.tw)

Figure 2. Read Command to Output Data Latency (Burst Length=2)

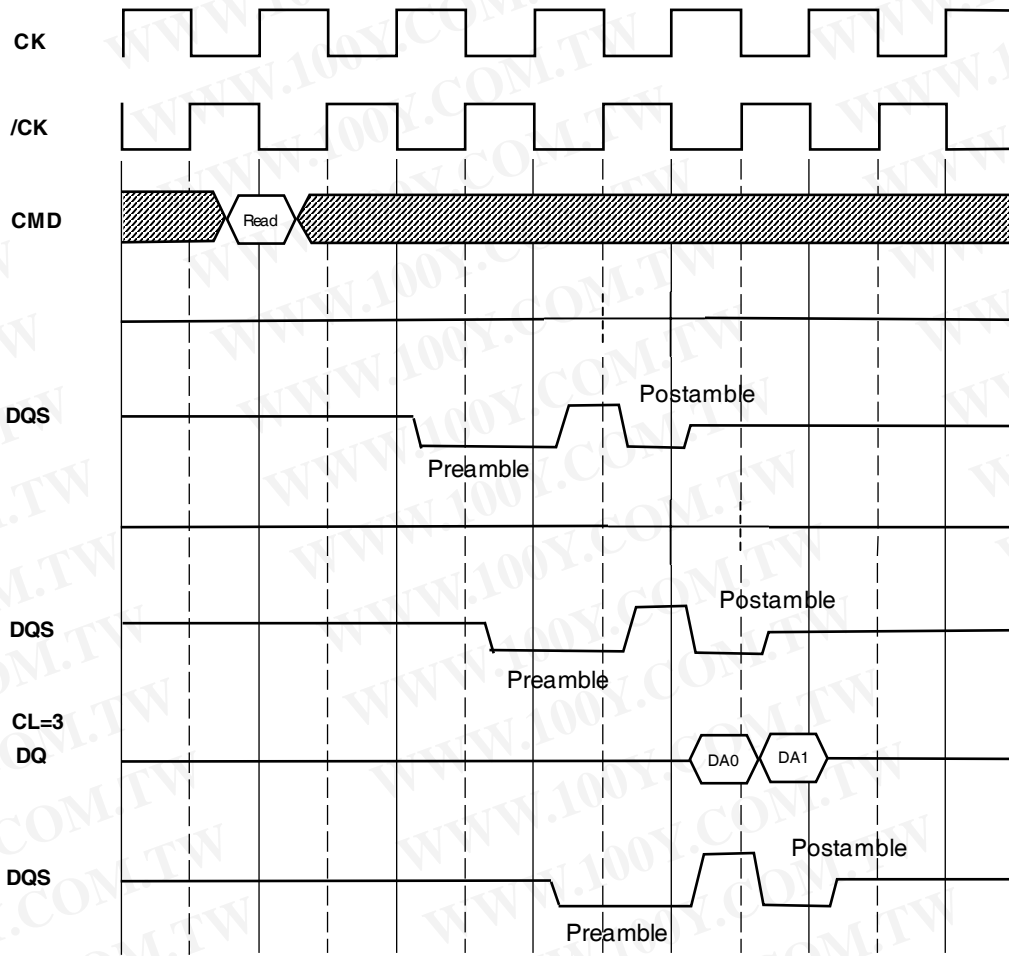

勝特力材料 886-3-5753170  
勝特力电子(上海) 86-21-34970699  
勝特力电子(深圳) 86-755-83298787  
[Http://www.100y.com.tw](http://www.100y.com.tw)

Figure 3. Read Followed by Write (Burst Lenth=4, CAS Latency=3)

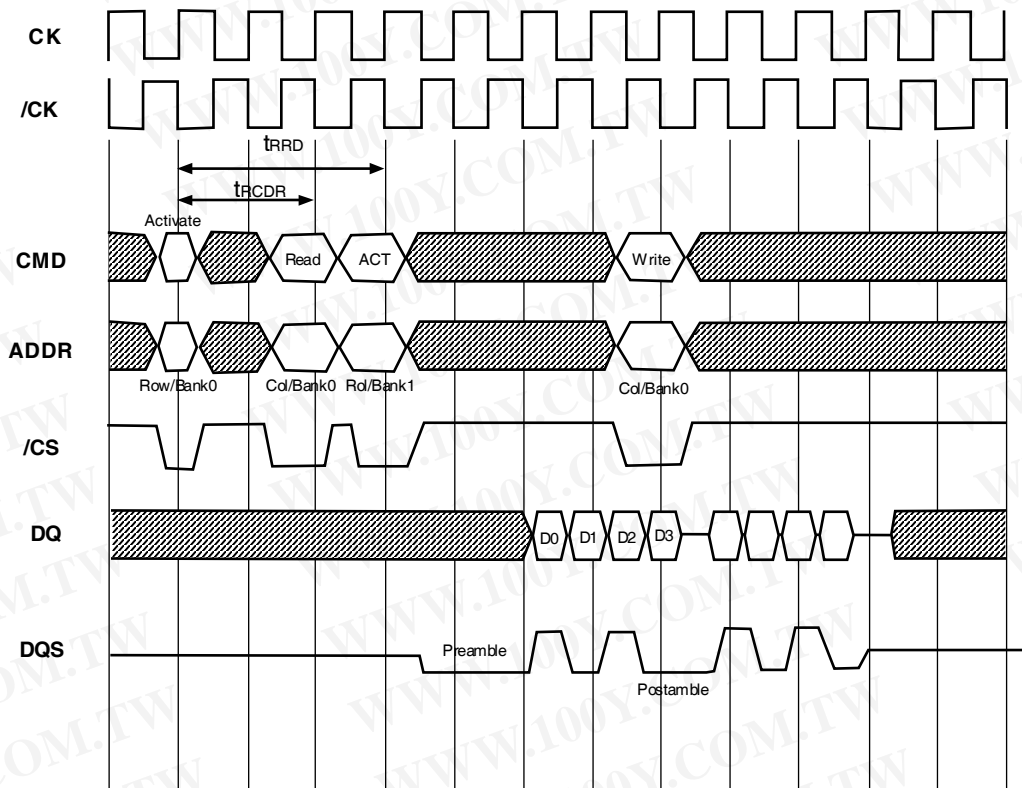

勝特力材料 886-3-5753170  
勝特力电子(上海) 86-21-34970699  
勝特力电子(深圳) 86-755-83298787  
[Http://www.100y.com.tw](http://www.100y.com.tw)

Figure 4. Write followed by Read (Burst Lenth=4, CAS Latency=3)

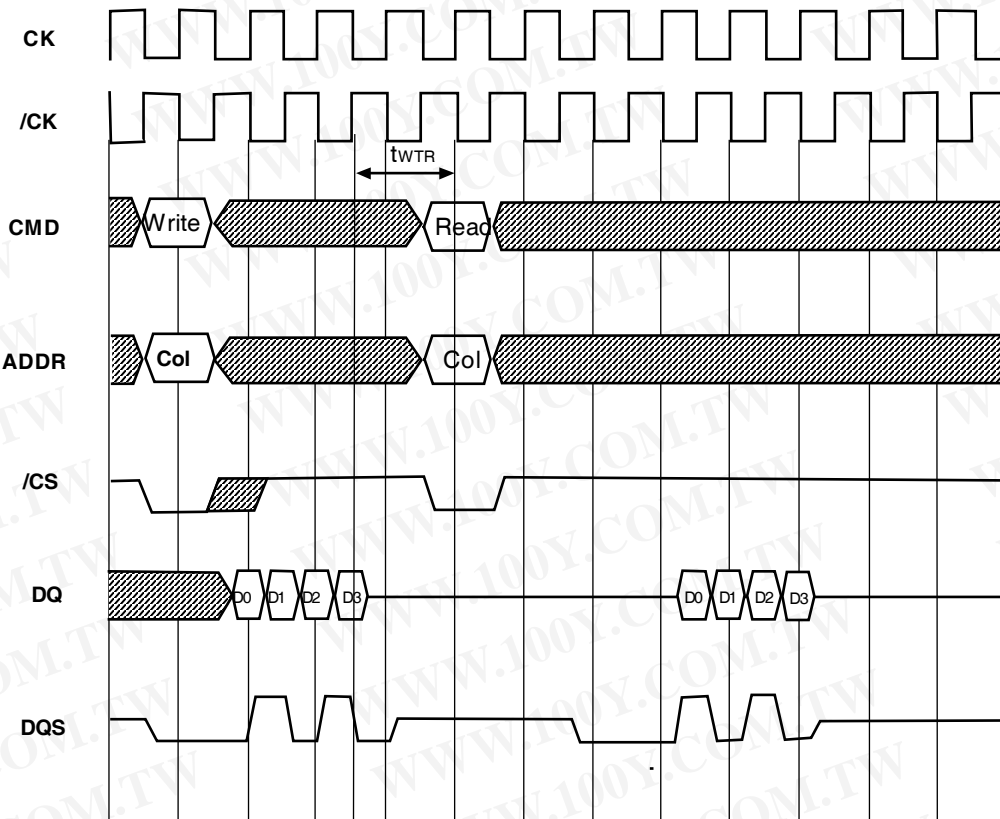

勝特力材料 886-3-5753170  
勝特力电子(上海) 86-21-34970699  
勝特力电子(深圳) 86-755-83298787  
[Http://www.100y.com.tw](http://www.100y.com.tw)

Figure 5. Precharge Termination of a Burst Read (Burst Length=4, CAS Latency=3)

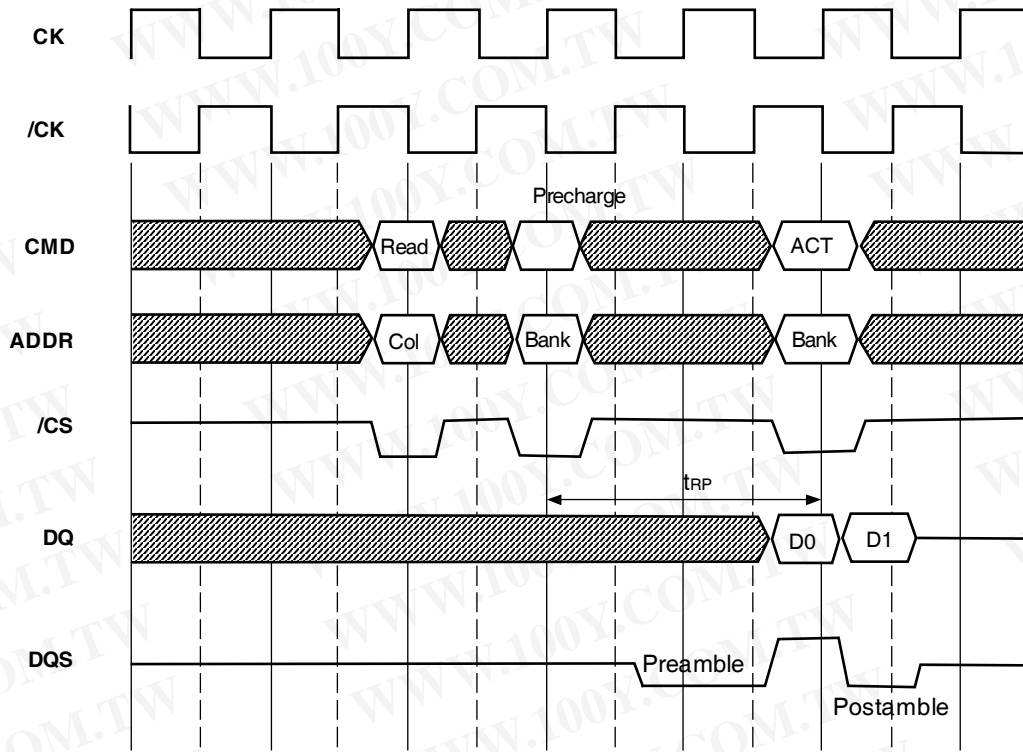

勝特力材料 886-3-5753170  
勝特力电子(上海) 86-21-34970699  
勝特力电子(深圳) 86-755-83298787  
[Http://www.100y.com.tw](http://www.100y.com.tw)

Figure 6. Precharge Termination of a Burst Write (Burst Length=4)

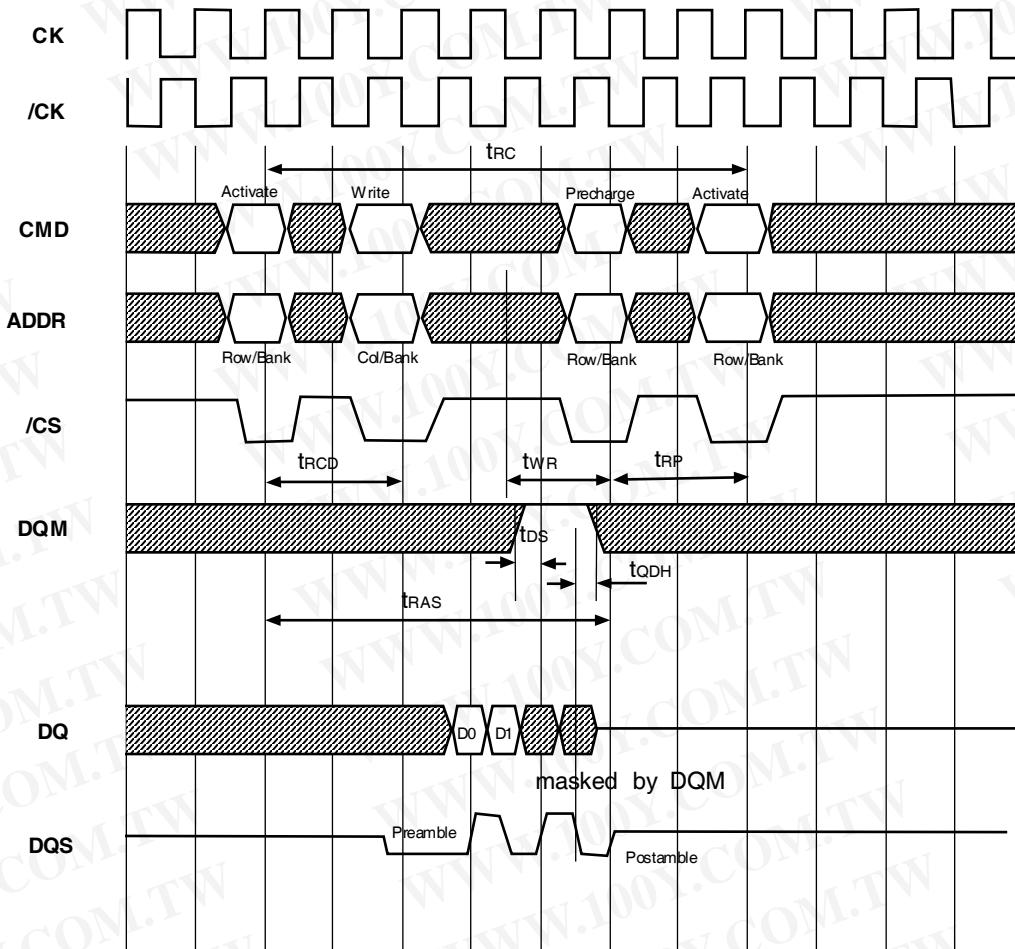

勝特力材料 886-3-5753170  
勝特力电子(上海) 86-21-34970699  
勝特力电子(深圳) 86-755-83298787  
[Http://www.100y.com.tw](http://www.100y.com.tw)

Figure 7. Auto Precharge after Read Burst (CAS Latency=3)

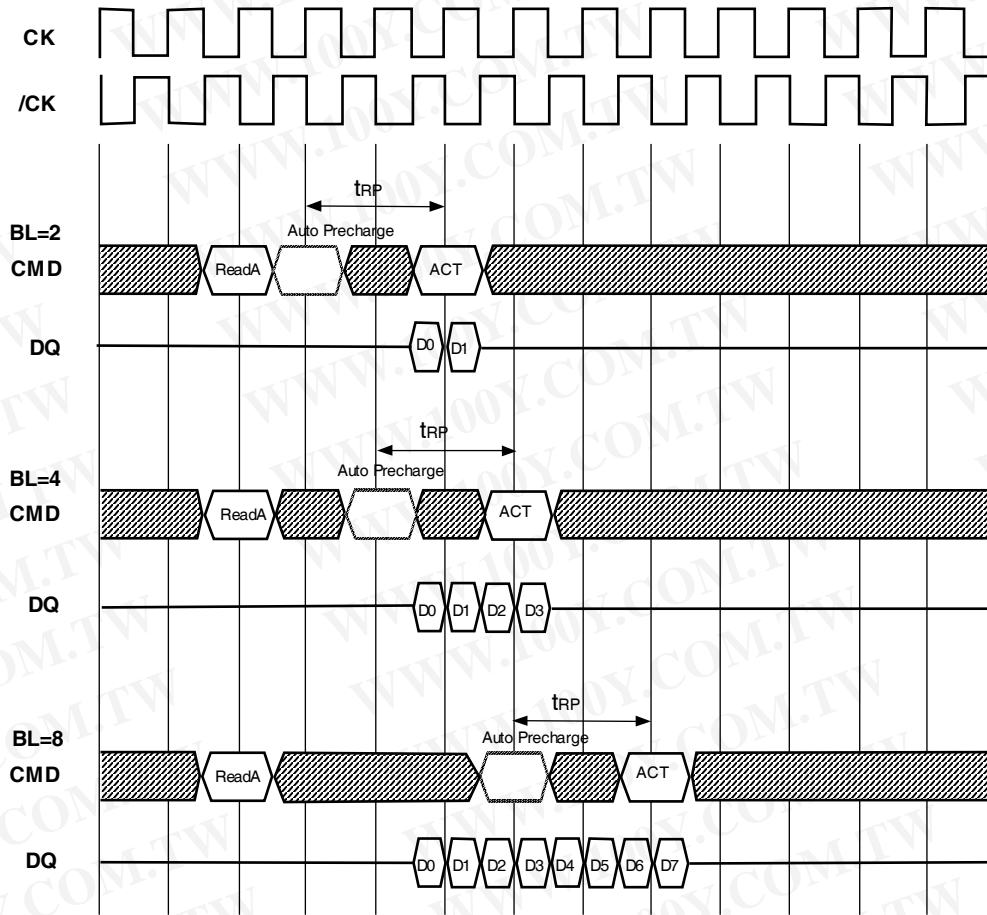

勝特力材料 886-3-5753170  
勝特力电子(上海) 86-21-34970699  
勝特力电子(深圳) 86-755-83298787  
[Http://www.100y.com.tw](http://www.100y.com.tw)

Figure 8. Auto Precharge after Write Burst

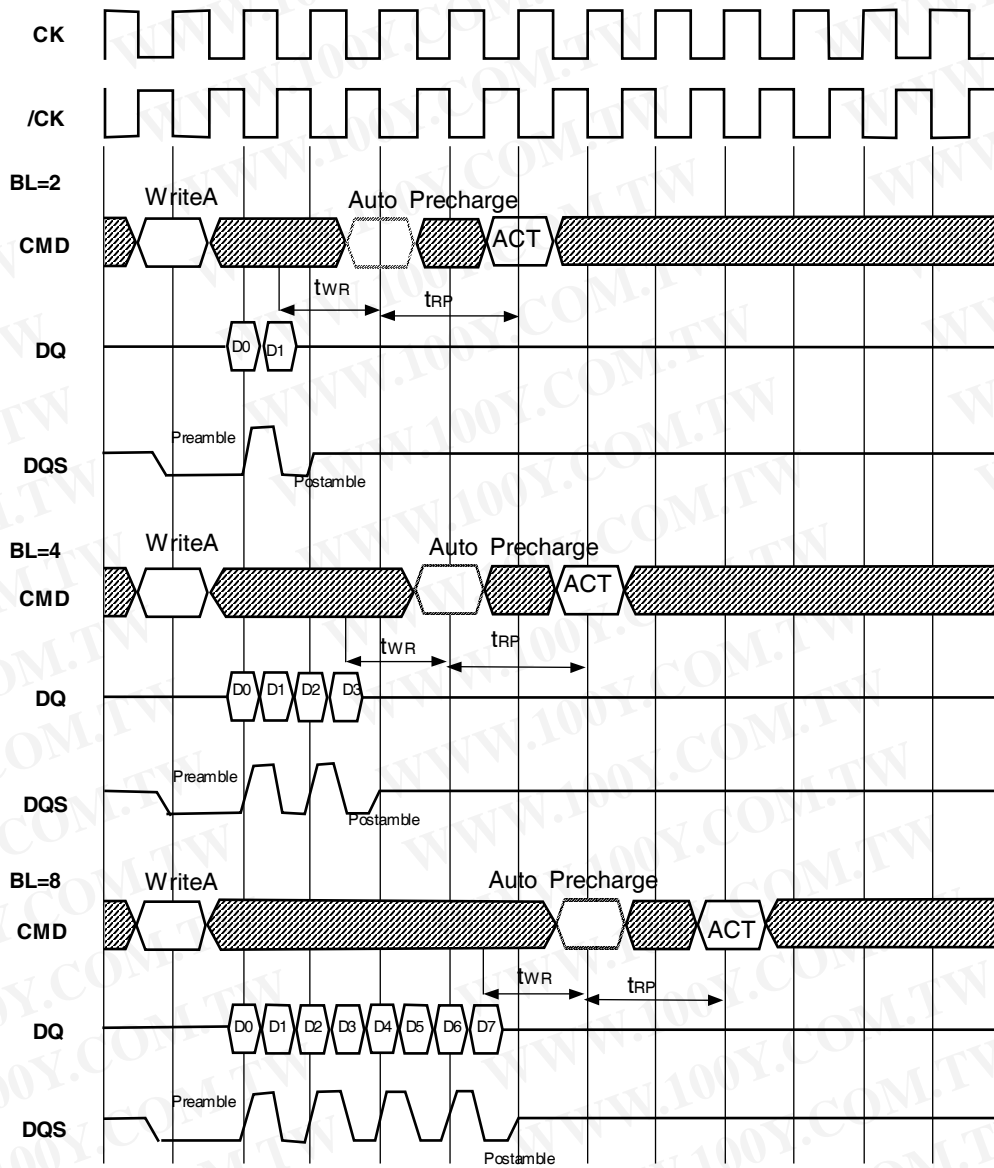

勝特力材料 886-3-5753170  
勝特力电子(上海) 86-21-34970699  
勝特力电子(深圳) 86-755-83298787  
[Http://www.100y.com.tw](http://www.100y.com.tw)

Figure 9. Read Terminated By Burst Stop (Burst Length=8)

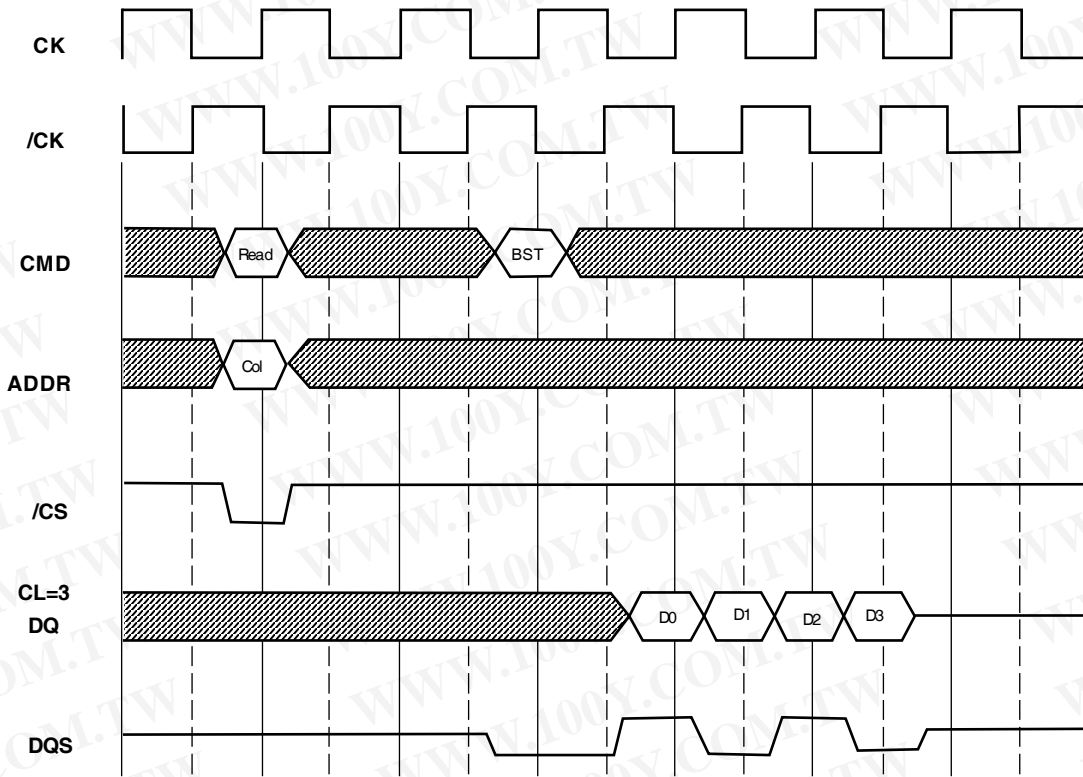

勝特力材料 886-3-5753170  
勝特力电子(上海) 86-21-34970699  
勝特力电子(深圳) 86-755-83298787  
[Http://www.100y.com.tw](http://www.100y.com.tw)

Figure 10. Read Terminated by Read (Burst Length=4, CAS Latency=3)

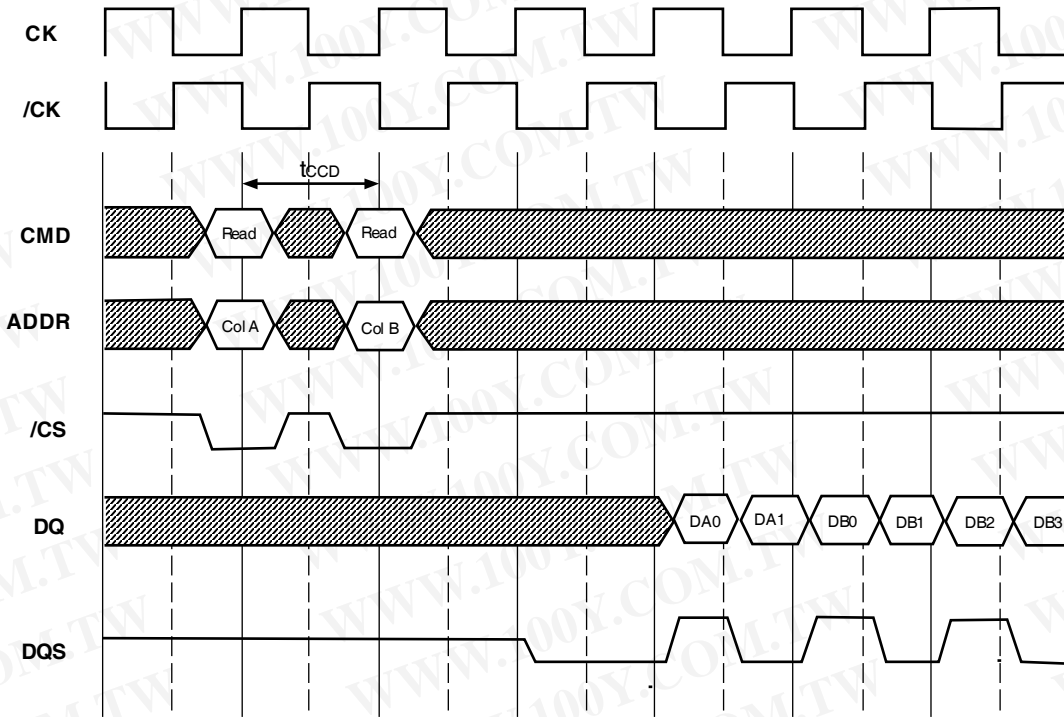

勝特力材料 886-3-5753170  
勝特力电子(上海) 86-21-34970699  
勝特力电子(深圳) 86-755-83298787  
[Http://www.100y.com.tw](http://www.100y.com.tw)

Figure 11. Mode Register Set Command

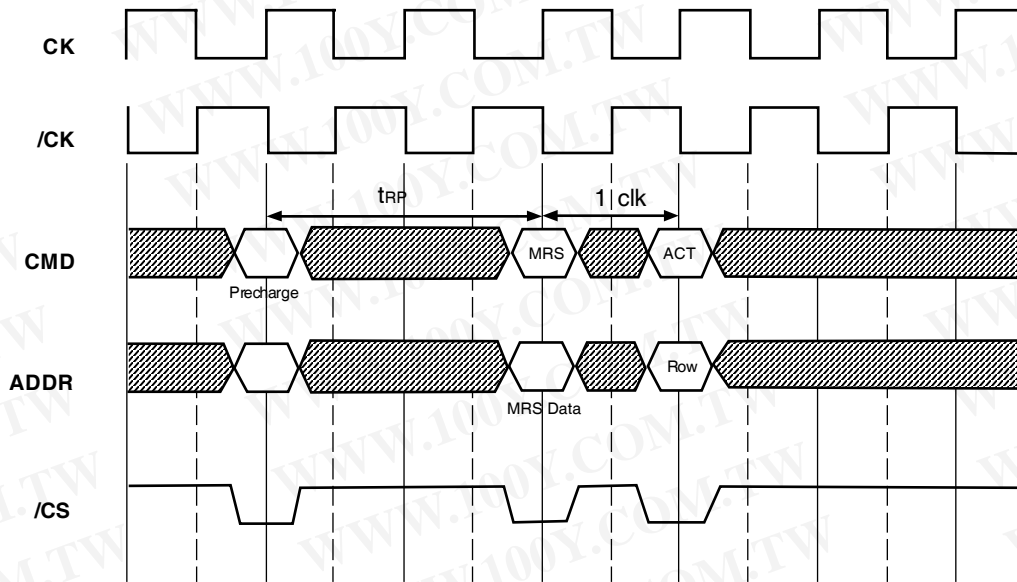

勝特力材料 886-3-5753170  
勝特力电子(上海) 86-21-34970699  
勝特力电子(深圳) 86-755-83298787  
[Http://www.100y.com.tw](http://www.100y.com.tw)

Figure 12. Active / Precharge Power Down Mode

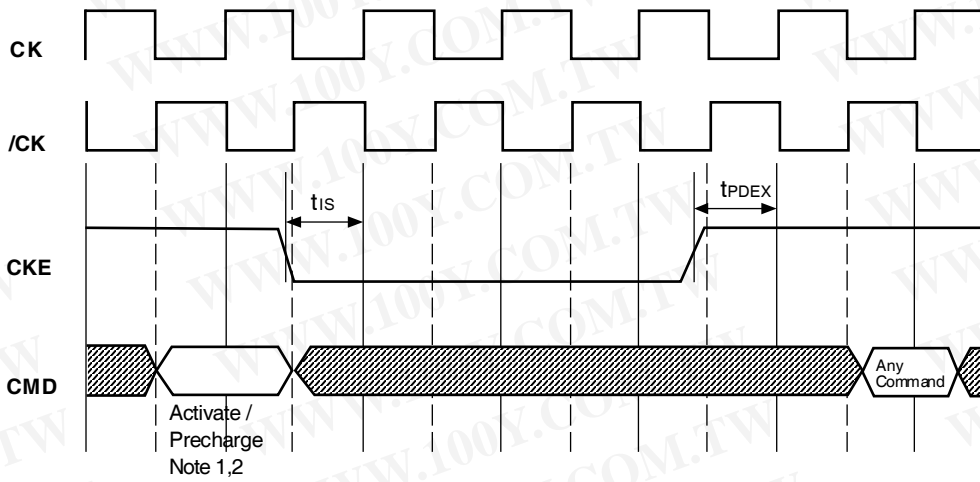

- Note:
1. All banks should be in idle state prior to entering precharge power down mode.
  2. One of the banks should be in active state prior to entering active power down mode.

勝特力材料 886-3-5753170  
勝特力电子(上海) 86-21-34970699  
勝特力电子(深圳) 86-755-83298787  
[Http://www.100y.com.tw](http://www.100y.com.tw)

Figure 13. Self Refresh Entry and Exit Cycle

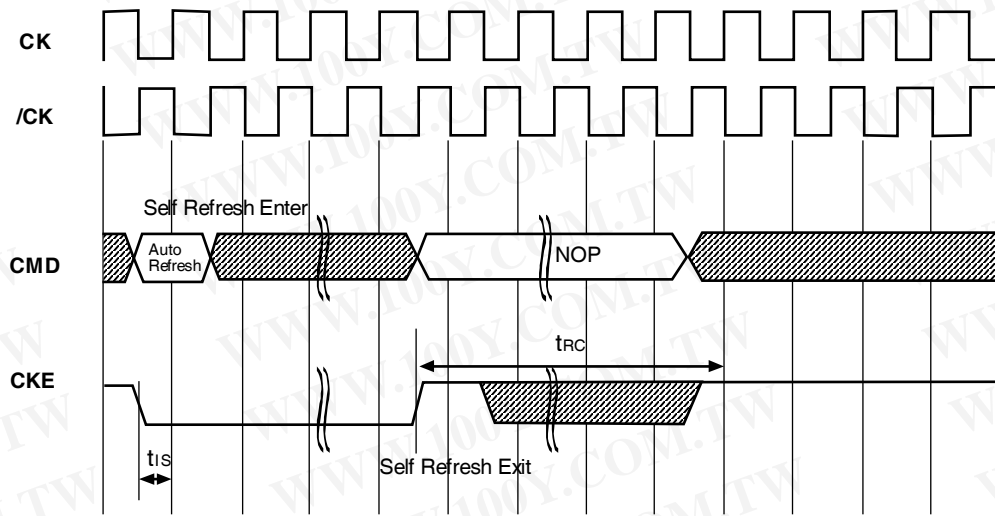

$t_{RC}$  is required before any command can be applied, and 200 cycles of  $clk$  are required before a READ command can be applied.

勝特力材料 886-3-5753170  
勝特力电子(上海) 86-21-34970699  
勝特力电子(深圳) 86-755-83298787  
[Http://www.100y.com.tw](http://www.100y.com.tw)

### 66 Pin TSOP II Package Outline Drawing Information

Units: mm

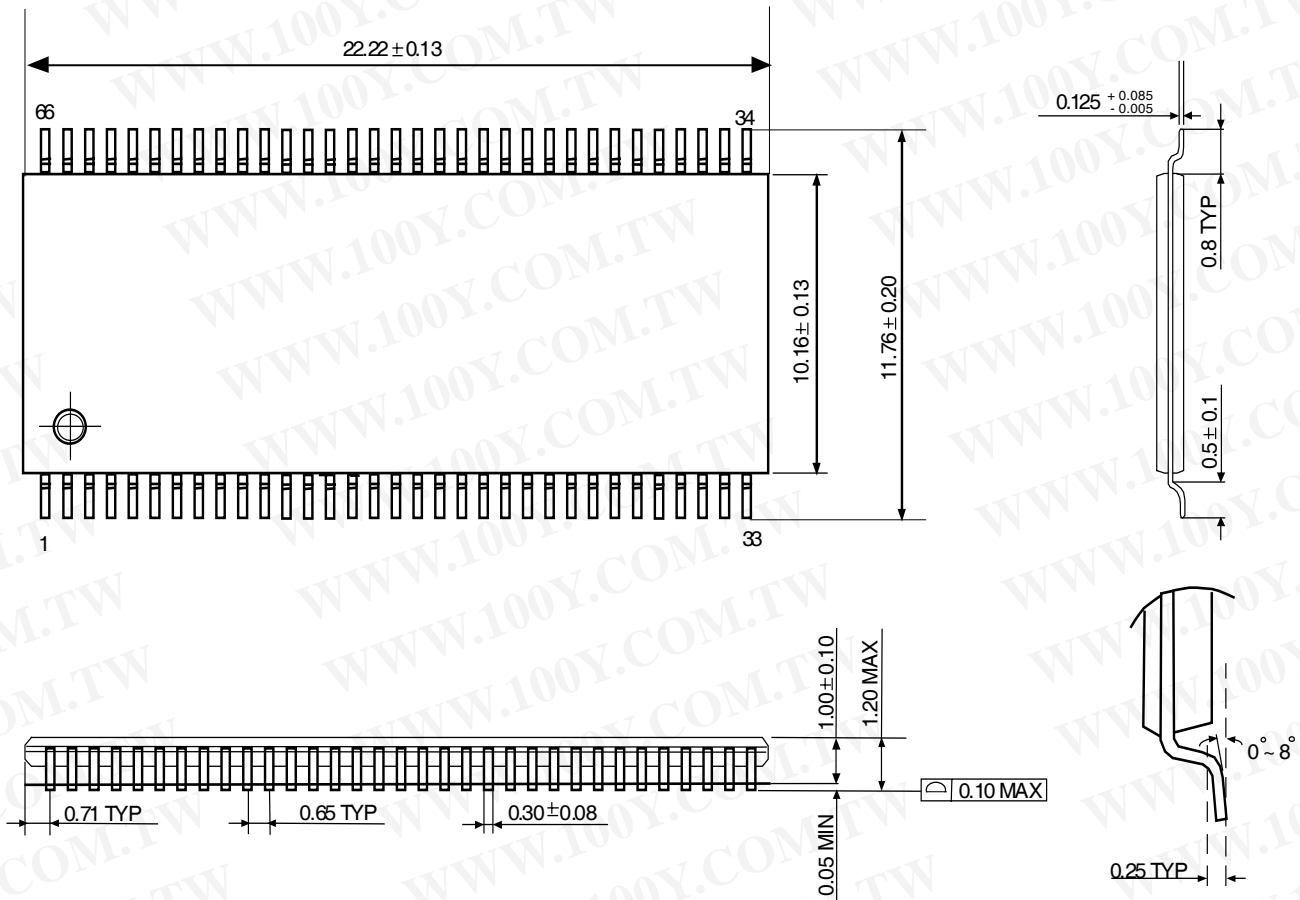

勝特力材料 886-3-5753170  
勝特力电子(上海) 86-21-34970699  
勝特力电子(深圳) 86-755-83298787  
[Http://www.100y.com.tw](http://www.100y.com.tw)