

Extended Common-Mode RS-485 Transceivers

 Check for Samples: [SN65HVD20](#), [SN65HVD21](#), [SN65HVD22](#), [SN65HVD23](#), [SN65HVD24](#)

FEATURES

- **Common-Mode Voltage Range (–20 V to 25 V) More Than Doubles TIA/EIA-485 Requirement**
- **Receiver Equalization Extends Cable Length, Signaling Rate (HVD23, HVD24)**
- **Reduced Unit-Load for up to 256 Nodes**
- **Bus I/O Protection to Over 16-kV HBM**
- **Failsafe Receiver for Open-Circuit, Short-Circuit and Idle-Bus Conditions**
- **Low Standby Supply Current 1- μ A Max**
- **More Than 100 mV Receiver Hysteresis**

APPLICATIONS

- **Long Cable Solutions**
 - **Factory Automation**
 - **Security Networks**
 - **Building HVAC**
- **Severe Electrical Environments**
 - **Electrical Power Inverters**
 - **Industrial Drives**
 - **Avionics**

DESCRIPTION

The transceivers in the HVD2x family offer performance far exceeding typical RS-485 devices. In addition to meeting all requirements of the TIA/EIA-485-A standard, the HVD2x family operates over an extended range of common-mode voltage, and has features such as high ESD protection, wide receiver hysteresis, and failsafe operation. This family of devices is ideally suited for long-cable networks, and other applications where the environment is too harsh for ordinary transceivers.

These devices are designed for bidirectional data transmission on multipoint twisted-pair cables. Example applications are digital motor controllers, remote sensors and terminals, industrial process control, security stations, and environmental control systems.

These devices combine a 3-state differential driver and a differential receiver, which operate from a single 5-V power supply. The driver differential outputs and the receiver differential inputs are connected internally to form a differential bus port that offers minimum loading to the bus. This port features an extended common-mode voltage range making the device suitable for multipoint applications over long cable runs.

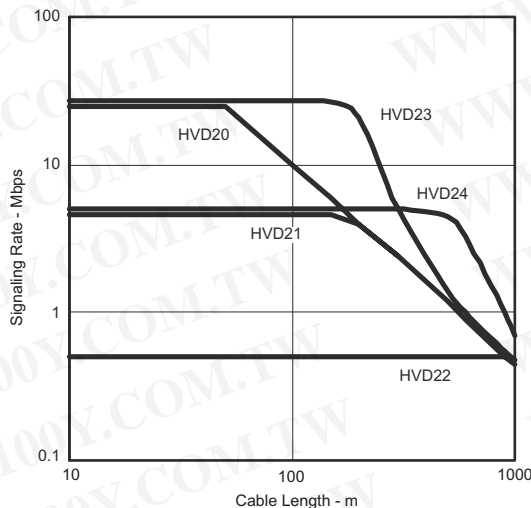
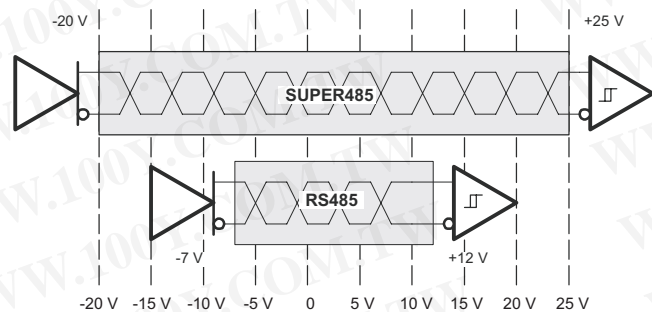
HVD2x APPLICATION SPACE

HVD2x Devices Operate Over a Wider Common-Mode Voltage Range

勝特力材料 886-3-5753170
勝特力电子(上海) 86-21-34970699
勝特力电子(深圳) 86-755-83298787
[Http://www.100y.com.tw](http://www.100y.com.tw)



Please be aware that an important notice concerning availability, standard warranty, and use in critical applications of Texas Instruments semiconductor products and disclaimers thereto appears at the end of this data sheet.



These devices have limited built-in ESD protection. The leads should be shorted together or the device placed in conductive foam during storage or handling to prevent electrostatic damage to the MOS gates.

DESCRIPTION (CONTINUED)

The 'HVD20 provides high signaling rate (up to 25 Mbps) for interconnecting networks of up to 64 nodes.

The 'HVD21 allows up to 256 connected nodes at moderate data rates (up to 5 Mbps). The driver output slew rate is controlled to provide reliable switching with shaped transitions which reduce high-frequency noise emissions.

The 'HVD22 has controlled driver output slew rate for low radiated noise in emission-sensitive applications and for improved signal quality with long stubs. Up to 256 'HVD22 nodes can be connected at signaling rates up to 500 kbps.

The 'HVD23 implements receiver equalization technology for improved jitter performance on differential bus applications with data rates up to 25 Mbps at cable lengths up to 160 meters.

The 'HVD24 implements receiver equalization technology for improved jitter performance on differential bus applications with data rates in the range of 1 Mbps to 10 Mbps at cable lengths up to 1000 meters.

The receivers also include a failsafe circuit that provides a high-level output within 250 microseconds after loss of the input signal. The most common causes of signal loss are disconnected cables, shorted lines, or the absence of any active transmitters on the bus. This feature prevents noise from being received as valid data under these fault conditions. This feature may also be used for Wired-Or bus signaling.

The SN65HVD2X devices are characterized for operation over the temperature range of -40°C to 85°C .

PRODUCT SELECTION GUIDE

PART NUMBERS	CABLE LENGTH AND SIGNALING RATE ⁽¹⁾	NODES	MARKING
SN65HVD20	Up to 50 m at 25 Mbps	Up to 64	D: VP20 P: 65HVD20
SN65HVD21	Up to 150 m at 5 Mbps (with slew rate limit)	Up to 256	D: VP21 P: 65HVD21
SN65HVD22	Up to 1200 m at 500 kbps (with slew rate limit)	Up to 256	D: VP22 P: 65HVD22
SN65HVD23	Up to 160 m at 25 Mbps (with receiver equalization)	Up to 64	D: VP23 P: 65HVD23
SN65HVD24	Up to 500 m at 3 Mbps (with receiver equalization)	Up to 256	D: VP24 P: 65HVD24

(1) Distance and signaling rate predictions based upon Belden 3105A cable and 15% eye pattern jitter.

AVAILABLE OPTIONS

PLASTIC THROUGH-HOLE P-PACKAGE (JEDEC MS-001)	PLASTIC SMALL-OUTLINE ⁽¹⁾ D-PACKAGE (JEDEC MS-012)
SN65HVD20P	SN65HVD20D
SN65HVD21P	SN65HVD21D
SN65HVD22P	SN65HVD22D
SN65HVD23P	SN65HVD23D
SN65HVD24P	SN65HVD24D

(1) Add R suffix for taped and reeled carriers.

勝特力材料 886-3-5753170
 勝特力电子(上海) 86-21-34970699
 勝特力电子(深圳) 86-755-83298787
[Http://www.100y.com.tw](http://www.100y.com.tw)

Table 1. DRIVER FUNCTION TABLE

HVD20, HVD21, HVD22				HVD23, HVD24			
INPUT D	ENABLE	OUTPUTS		INPUT D	ENABLE	OUTPUTS	
	DE	A	B		DE	A	B
H	H	H	L	H	H	H	L
L	H	L	H	L	H	L	H
X	L	Z	Z	X	L	Z	Z
X	OPEN	Z	Z	X	OPEN	Z	Z
OPEN	H	H	L	OPEN	H	L	H

H = high level, L = low level, X = don't care, Z = high impedance (off), ? = indeterminate

Table 2. RECEIVER FUNCTION TABLE

DIFFERENTIAL INPUT $V_{ID} = (V_A - V_B)$	ENABLE \overline{RE}	OUTPUT R
$0.2\text{ V} \leq V_{ID}$	L	H
$-0.2\text{ V} < V_{ID} < 0.2\text{ V}$	L	H (see Note ⁽¹⁾)
$V_{ID} \leq -0.2\text{ V}$	L	L
X	H	Z
X	OPEN	Z
Open circuit	L	H
Short Circuit	L	H
Idle (terminated) bus	L	H

H = high level, L = low level, Z = high impedance (off)

- (1) If the differential input V_{ID} remains within the transition range for more than 250 μs , the integrated failsafe circuitry detects a bus fault, and set the receiver output to a high state. See [Figure 15](#).

ABSOLUTE MAXIMUM RATINGS

over operating free-air temperature range (unless otherwise noted) ⁽¹⁾

		SN65HVD2X
Supply voltage ⁽²⁾ , V_{CC}		-0.5 V to 7 V
Voltage at any bus I/O terminal		-27 V to 27 V
Voltage input, transient pulse, A and B, (through 100 Ω , see Figure 16)		-60 V to 60 V
Voltage input at any D, DE or \overline{RE} terminal		-0.5 V to $V_{CC} + 0.5\text{ V}$
Receiver output current, I_O		-10 mA to 10 mA
Electrostatic discharge	Human Body Model ⁽³⁾	A, B, GND All pins
	Charged-Device Model ⁽⁴⁾	All pins
	Machine Model ⁽⁵⁾	All pins
Continuous total power dissipation		See Thermal Table
Junction temperature, T_J		150°C

- (1) Stresses beyond those listed under "absolute maximum ratings" may cause permanent damage to the device. These are stress ratings only, and functional operation of the device at these or any other conditions beyond those indicated under "recommended operating conditions" is not implied. Exposure to absolute-maximum-rated conditions for extended periods may affect device reliability.
- (2) All voltage values, except differential I/O bus voltages, are with respect to network ground terminal.
- (3) Tested in accordance with JEDEC Standard 22, Test Method A114-A.
- (4) Tested in accordance with JEDEC Standard 22, Test Method C101.
- (5) Tested in accordance with JEDEC Standard 22, Test Method A115-A

RECOMMENDED OPERATING CONDITIONS

		MIN	NOM	MAX	UNIT
Supply voltage, V_{CC}		4.5	5	5.5	V
Voltage at any bus I/O terminal	A, B	-20		25	V
High-level input voltage, V_{IH}	D, DE, \overline{RE}	2		V_{CC}	V
Low-level input voltage, V_{IL}		0		0.8	
Differential input voltage, V_{ID}	A with respect to B	-25		25	V
Output current	Driver	-110		110	mA
	Receiver	-8		8	
Operating free-air temperature, $T_A^{(1)}$		-40		85	°C
Junction temperature, T_J		-40		130	°C

(1) Maximum free-air temperature operation is allowed as long as the device recommended junction temperature is not exceeded.

DRIVER ELECTRICAL CHARACTERISTICS

over recommended operating conditions

PARAMETER		TEST CONDITIONS	MIN	TYP ⁽¹⁾	MAX	UNIT
V_{IK}	Input clamp voltage	$I_I = -18$ mA	-1.5	0.75		V
V_O	Open-circuit output voltage	A or B, No load	0		V_{CC}	V
$ V_{OD(SS)} $	Steady-state differential output voltage	No load (open circuit)	3.3	4.2	V_{CC}	V
		$R_L = 54 \Omega$, See Figure 1	1.8	2.5		
		With common-mode loading, See Figure 2	1.8			
$\Delta V_{OD(SS)} $	Change in steady-state differential output voltage between logic states	See Figure 1 and Figure 3	-0.1		0.1	V
$V_{OC(SS)}$	Steady-state common-mode output voltage	See Figure 1	2.1	2.5	2.9	V
$\Delta V_{OC(SS)}$	Change in steady-state common-mode output voltage, $V_{OC(H)} - V_{OC(L)}$	See Figure 1 and Figure 4	-0.1		0.1	V
$V_{OC(PP)}$	Peak-to-peak common-mode output voltage, $V_{OC(MAX)} - V_{OC(MIN)}$	$R_L = 54 \Omega$, $C_L = 50$ pF, See Figure 1 and Figure 4	0.35			V
$V_{OD(RING)}$	Differential output voltage over and under shoot	$R_L = 54 \Omega$, $C_L = 50$ pF, See Figure 5			10%	
I_I	Input current	D, DE	-100		100	μ A
I_O	Output current with power off. High impedance state output current.	$V_O < -7$ V to 12 V, Other input = 0 V	HVD20, HVD23	-400	500	μ A
			HVD21, HVD22, HVD24	-100	125	
		$V_O < -20$ V to 25 V, Other input = 0 V	HVD20, HVD23	-800	1000	
			HVD21, HVD22, HVD24	-200	250	
I_{OS}	Short-circuit output current	$V_O = -20$ V to 25 V, See Figure 9	-250		250	mA
C_{OD}	Differential output capacitance				20	pF

(1) All typical values are at $V_{CC} = 5$ V and 25°C.

勝特力材料 886-3-5753170
 勝特力电子(上海) 86-21-34970699
 勝特力电子(深圳) 86-755-83298787
[Http://www.100y.com.tw](http://www.100y.com.tw)

DRIVER SWITCHING CHARACTERISTICS

over recommended operating conditions

PARAMETER		TEST CONDITIONS		MIN	TYP ⁽¹⁾	MAX	UNIT
t_{PLH}	Differential output propagation delay, low-to-high	$R_L = 54 \Omega$, $C_L = 50 \text{ pF}$, See Figure 3	HVD20, HVD23	6	10	20	ns
t_{PHL}	Differential output propagation delay, high-to-low		HVD21, HVD24	20	32	60	
			HVD22	160	280	500	
t_r	Differential output rise time	$R_L = 54 \Omega$, $C_L = 50 \text{ pF}$, See Figure 3	HVD20, HVD23	2	6	12	ns
t_f	Differential output fall time		HVD21, HVD24	20	40	60	
			HVD22	200	400	600	
t_{PZH}	Propagation delay time, high-impedance-to-high-level output	\overline{RE} at 0 V, See Figure 6	HVD20, HVD23			40	ns
t_{PHZ}	Propagation delay time, high-level output-to-high-impedance		HVD21, HVD24			100	
			HVD22			300	
t_{PZL}	Propagation delay time, high-impedance-to-high-level output	\overline{RE} at 0 V, See Figure 7	HVD20, HVD23			40	ns
t_{PLZ}	Propagation delay time, high-level output-to-high-impedance		HVD21, HVD24			100	
			HVD22			300	
$t_{d(\text{standby})}$	Time from an active differential output to standby	\overline{RE} at V_{CC} , See Figure 8				2	μs
$t_{d(\text{wake})}$	Wake-up time from standby to an active differential output					8	μs
$t_{sk(p)}$	Pulse skew $t_{PLH} - t_{PHL}$	HVD20, HVD23				2	ns
		HVD21, HVD24				6	
		HVD22				50	

 (1) All typical values are at $V_{CC} = 5 \text{ V}$ and 25°C

RECEIVER ELECTRICAL CHARACTERISTICS

over recommended operating conditions

PARAMETER		TEST CONDITIONS		MIN	TYP ⁽¹⁾	MAX	UNIT
$V_{IT(+)}$	Positive-going differential input voltage threshold	See Figure 10	$V_O = 2.4 \text{ V}$, $I_O = -8 \text{ mA}$		60	200	mV
$V_{IT(-)}$	Negative-going differential input voltage threshold		$V_O = 0.4 \text{ V}$, $I_O = 8 \text{ mA}$	-200	-60		
V_{HYS}	Hysteresis voltage ($V_{IT+} - V_{IT-}$)			100	130		mV
$V_{IT(F+)}$	Positive-going differential input failsafe voltage threshold	See Figure 15	$V_{CM} = -7 \text{ V}$ to 12 V	40	120	200	mV
			$V_{CM} = -20 \text{ V}$ to 25 V		120	250	
$V_{IT(F-)}$	Negative-going differential input failsafe voltage threshold	See Figure 15	$V_{CM} = -7 \text{ V}$ to 12 V	-200	-120	-40	mV
			$V_{CM} = -20 \text{ V}$ to 25 V	-250	-120		
V_{IK}	Input clamp voltage	$I_I = -18 \text{ mA}$		-1.5			V
V_{OH}	High-level output voltage	$V_{ID} = 200 \text{ mV}$, $I_{OH} = -8 \text{ mA}$, See Figure 11		4			V
V_{OL}	Low-level output voltage	$V_{ID} = -200 \text{ mV}$, $I_{OL} = 8 \text{ mA}$, See Figure 11				0.4	V
$I_{I(\text{BUS})}$	Bus input current (power on or power off)	$V_I = -7$ to 12 V , Other input = 0 V	HVD20, HVD23	-400		500	μA
			HVD21, HVD22, HVD24	-100		125	
		$V_I = -20$ to 25 V , Other input = 0 V	HVD20, HVD23	-800		1000	
			HVD21, HVD22, HVD24	-200		250	
I_I	Input current	RE		-100		100	μA
R_I	Input resistance Input resistance	HVD20, HVD23		24			k Ω
		HVD21, HVD22, HVD24		96			
C_{ID}	Differential input capacitance	$V_{ID} = 0.5 + 0.4 \text{ sine}(2\pi \times 1.5 \times 10^6 t)$			20		pF

 (1) All typical values are at 25°C .

勝特力材料 886-3-5753170
 勝特力电子(上海) 86-21-34970699
 勝特力电子(深圳) 86-755-83298787
[Http://www.100y.com.tw](http://www.100y.com.tw)

RECEIVER SWITCHING CHARACTERISTICS

over recommended operating conditions (unless otherwise noted)

PARAMETER		TEST CONDITIONS		MIN	TYP	MAX	UNIT
t_{PLH}	Propagation delay time, low-to-high level output	See Figure 11	HVD20, HVD23		16	35	ns
t_{PHL}	Propagation delay time high-to low level output		HVD21, HVD22, HVD24		25	50	
t_r t_f	Receiver output rise time Receiver output fall time	See Figure 11			2	4	ns
t_{PZH}	Receiver output enable time to high level	See Figure 12			90	120	ns
t_{PHZ}	Receiver output disable time from high level				16	35	
t_{PZL}	Receiver output enable time to low level	See Figure 13			90	120	ns
t_{PLZ}	Receiver output disable time from low level				16	35	
$t_{r(standby)}$	Time from an active receiver output to standby	See Figure 14, DE at 0 V				2	μ s
$t_{r(wake)}$	Wake-up time from standby to an active receiver output					8	
$t_{sk(p)}$	Pulse skew $ t_{PLH} - t_{PHL} $					5	
$t_{p(set)}$	Delay time, bus fail to failsafe set	See Figure 15, pulse rate = 1 kHz			250	350	μ s
$t_{p(reset)}$	Delay time, bus recovery to failsafe reset				50		ns

RECEIVER EQUALIZATION CHARACTERISTICS⁽¹⁾

over recommended operating conditions

PARAMETER		TEST CONDITIONS			MIN	TYP ⁽²⁾	MAX	UNIT
$t_{j(pp)}$	Peak-to-peak eye-pattern jitter	Pseudo-random NRZ code with a bit pattern length of $2^{16} - 1$, Beldon 3105A cable, See Figure 27	25 Mbps	0 m	HVD23		2	ns
				100 m	HVD20		6	ns
			HVD23			3		
			150 m	HVD20		15	ns	
				HVD23		4		
			200 m	HVD20		27	ns	
				HVD23		8		
			10 Mbps	200 m	HVD20		22	ns
					HVD23		8	
				250 m	HVD20		34	ns
					HVD23		15	
			300 m	HVD20		49	ns	
				HVD23		27		
			5 Mbps	500 m	HVD21		128	ns
HVD24		18						
3 Mbps	500 m	HVD20		93	ns			
		HVD21		103				
		HVD23		90				
		HVD24		16				
1 Mbps	1000 m	HVD21		216	ns			
		HVD24		62				

(1) The HVD20 and HVD21 do not have receiver equalization, but are specified for comparison.

(2) All typical values are at $V_{CC} = 5$ V, and temperature = 25°C.

勝特力材料 886-3-5753170
勝特力电子(上海) 86-21-34970699
勝特力电子(深圳) 86-755-83298787
[Http://www.100y.com.tw](http://www.100y.com.tw)

SUPPLY CURRENT

over recommended operating conditions (unless otherwise noted)

PARAMETER		TEST CONDITIONS	MIN	TYP	MAX	UNIT
I _{CC}	Supply current	Driver enabled (DE at V _{CC}), Receiver enabled (RE at 0 V), No load, V _I = 0 V or V _{CC}	HVD20	6	9	mA
			HVD21	8	12	
			HVD22	6	9	
			HVD23	7	11	
			HVD24	10	14	
			HVD20	5	8	
		Driver enabled (DE at V _{CC}), Receiver disabled (RE at V _{CC}), No load, V _I = 0 V or V _{CC}	HVD22	5	8	mA
			HVD23	5	9	
			HVD24	8	12	
		Driver disabled (DE at 0 V), Receiver enabled (RE at 0 V), No load	HVD20	4	7	mA
			HVD21	5	8	
			HVD22	4	7	
			HVD23	4.5	9	
		Driver disabled (DE at 0 V), Receiver disabled (RE at V _{CC}) D open	HVD24	5.5	10	μA
All HVD2x			1			

勝特力材料 886-3-5753170
勝特力电子(上海) 86-21-34970699
勝特力电子(深圳) 86-755-83298787
[Http://www.100y.com.tw](http://www.100y.com.tw)

EQUIVALENT INPUT AND OUTPUT SCHEMATIC DIAGRAMS

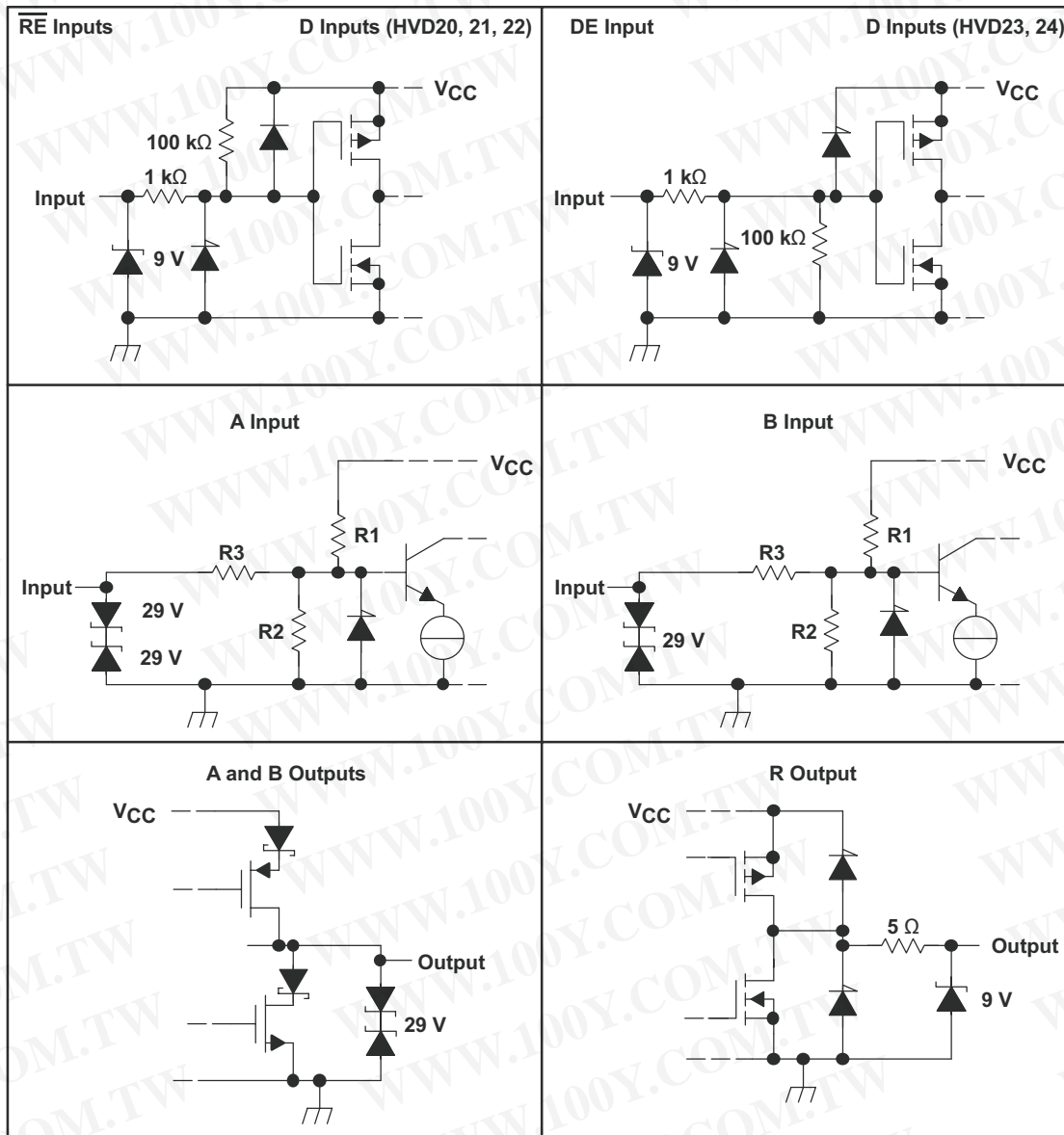

	R1/R2	R3
HVD20, 23	9 kΩ	45 kΩ
HVD21, 22, 24	36 kΩ	180 kΩ

勝特力材料 886-3-5753170
 勝特力电子(上海) 86-21-34970699
 勝特力电子(深圳) 86-755-83298787
[Http://www.100y.com.tw](http://www.100y.com.tw)

PARAMETER MEASUREMENT INFORMATION

NOTE: Test load capacitance includes probe and jig capacitance (unless otherwise specified). Signal generator characteristics: rise and fall time <6 ns, pulse rate 100 kHz, 50% duty cycle, $Z_o = 50 \Omega$ (unless otherwise specified).

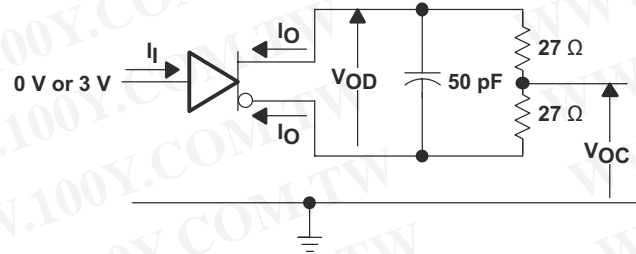

Figure 1. Driver Test Circuit, V_{OD} and V_{OC} Without Common-Mode Loading

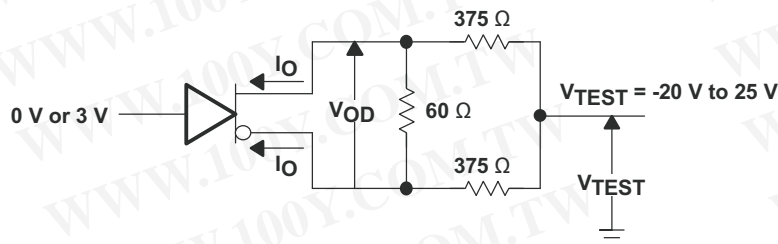

Figure 2. Driver Test Circuit, V_{OD} With Common-Mode Loading

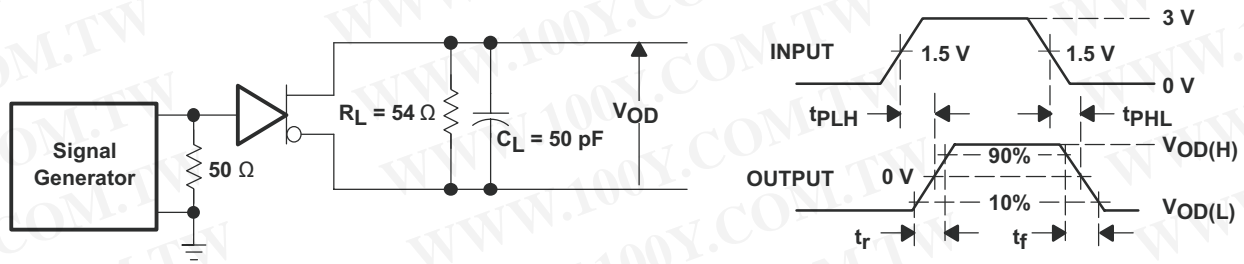

Figure 3. Driver Switching Test Circuit and Waveforms

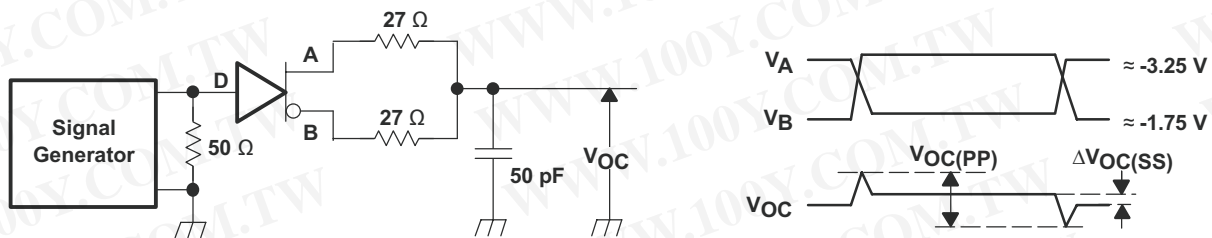
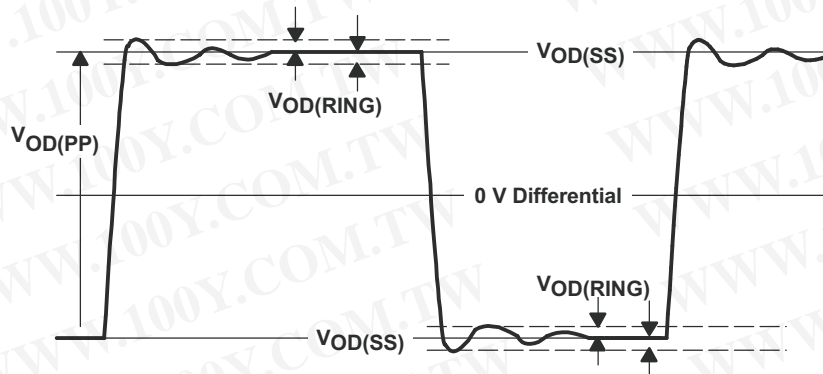

Figure 4. Driver V_{OC} Test Circuit and Waveforms

勝特力材料 886-3-5753170
勝特力电子(上海) 86-21-34970699
勝特力电子(深圳) 86-755-83298787
[Http://www.100y.com.tw](http://www.100y.com.tw)

PARAMETER MEASUREMENT INFORMATION (continued)



NOTE: $V_{OD(RING)}$ is measured at four points on the output waveform, corresponding to overshoot and undershoot from the $V_{OD(H)}$ and $V_{OD(L)}$ steady state values.

Figure 5. $V_{OD(RING)}$ Waveform and Definitions

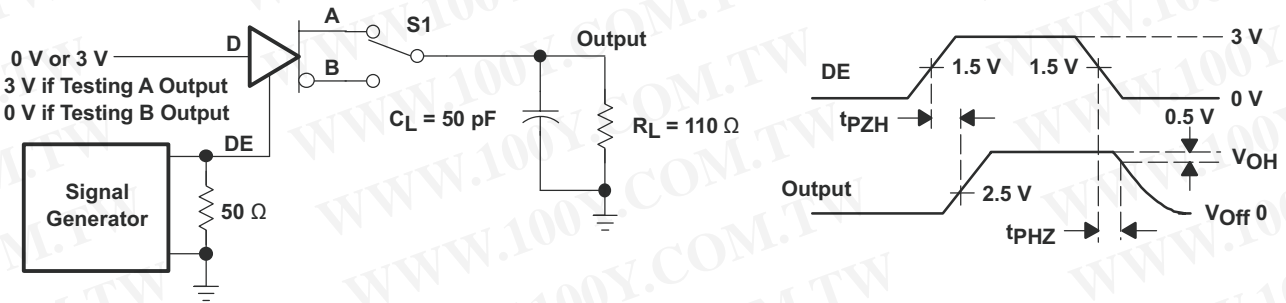

Figure 6. Driver Enable/Disable Test, High Output

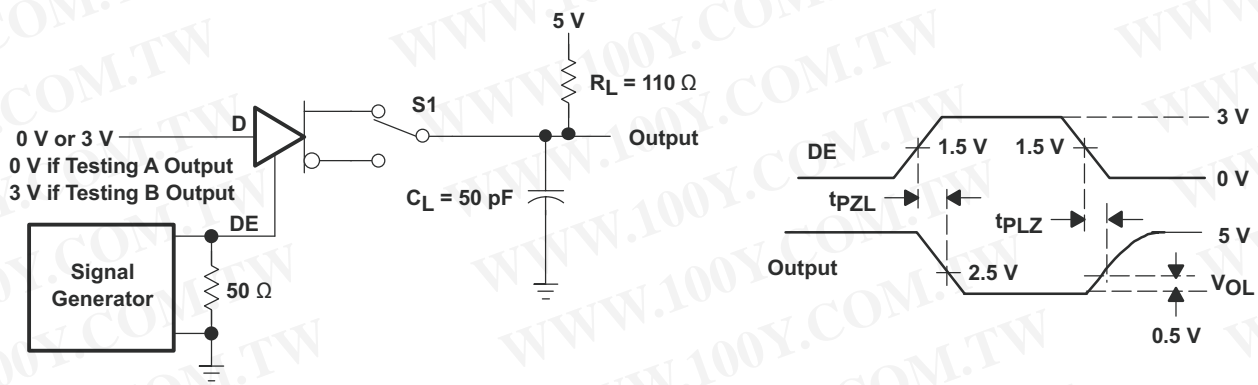

Figure 7. Driver Enable/Disable Test, Low Output

勝特力材料 886-3-5753170
勝特力电子(上海) 86-21-34970699
勝特力电子(深圳) 86-755-83298787
[Http://www.100y.com.tw](http://www.100y.com.tw)

PARAMETER MEASUREMENT INFORMATION (continued)

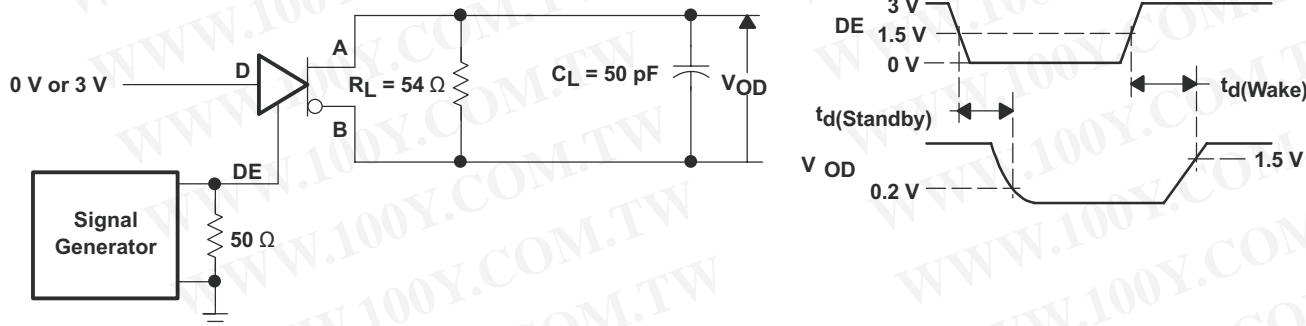

Figure 8. Driver Standby/Wake Test Circuit and Waveforms

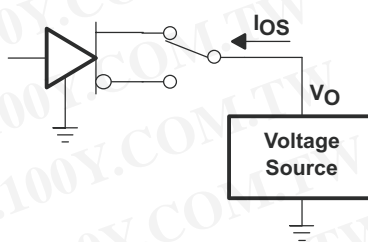

Figure 9. Driver Short-Circuit Test

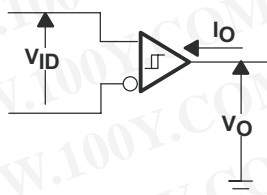

Figure 10. Receiver DC Parameter Definitions

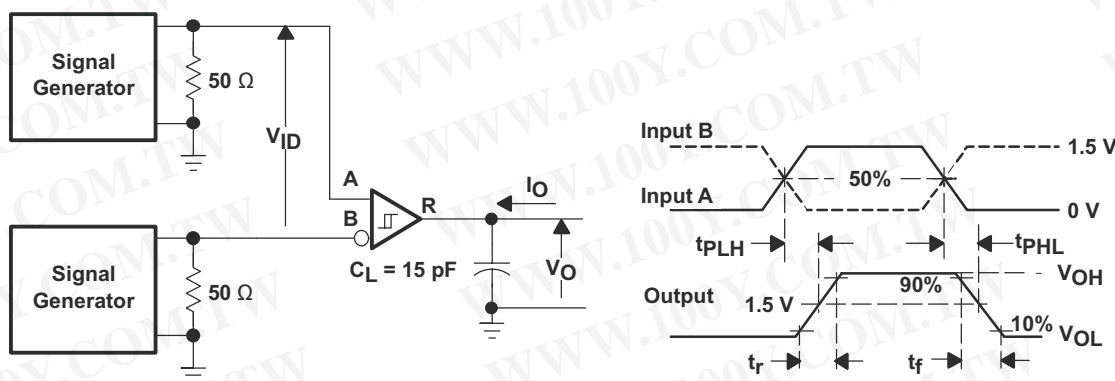

Figure 11. Receiver Switching Test Circuit and Waveforms

勝特力材料 886-3-5753170
 勝特力电子(上海) 86-21-34970699
 勝特力电子(深圳) 86-755-83298787
[Http://www.100y.com.tw](http://www.100y.com.tw)

PARAMETER MEASUREMENT INFORMATION (continued)

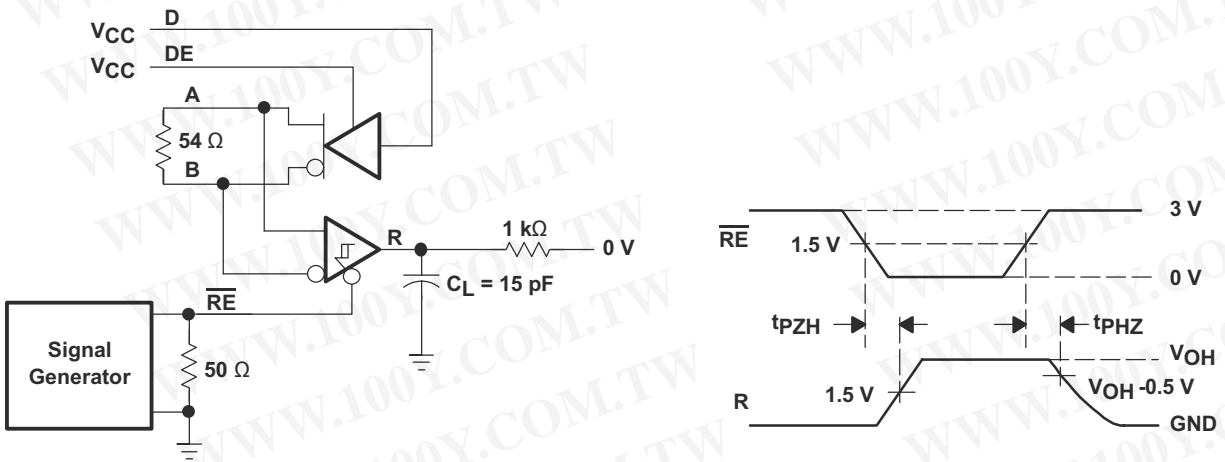
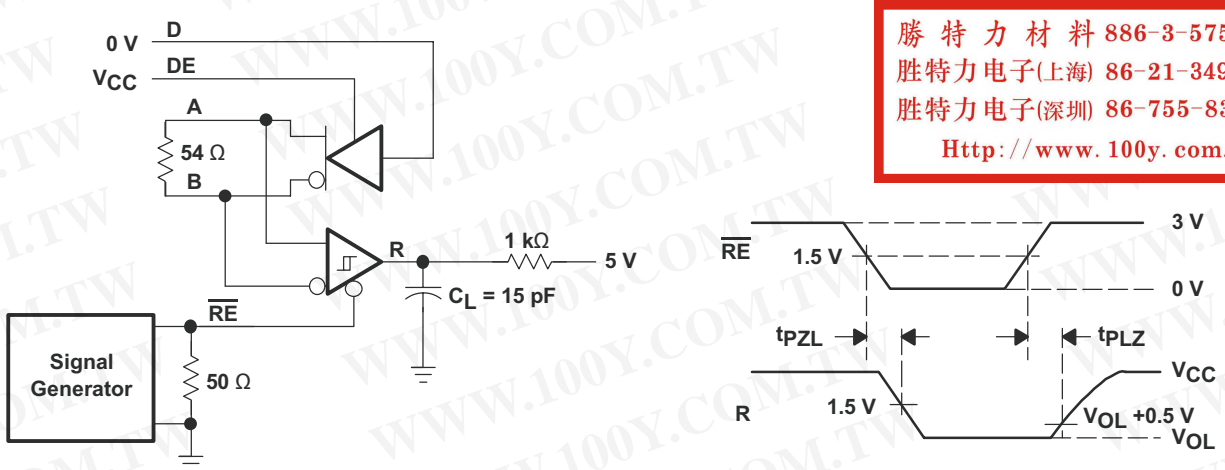

Figure 12. Receiver Enable Test Circuit and Waveforms, Data Output High



勝特力材料 886-3-5753170
 勝特力电子(上海) 86-21-34970699
 勝特力电子(深圳) 86-755-83298787
[Http://www.100y.com.tw](http://www.100y.com.tw)

Figure 13. Receiver Enable Test Circuit and Waveforms, Data Output Low

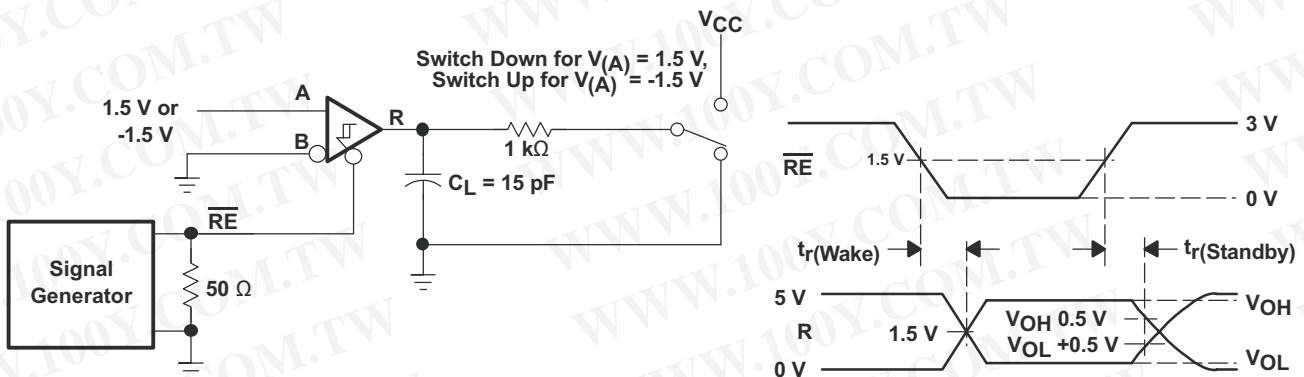

Figure 14. Receiver Standby and Wake Test Circuit and Waveforms

PARAMETER MEASUREMENT INFORMATION (continued)

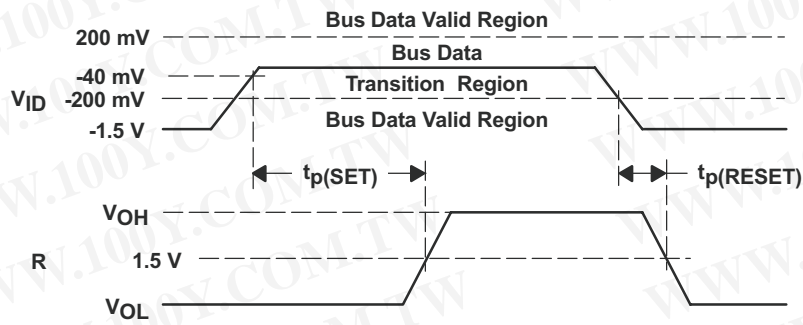

Figure 15. Receiver Active Failsafe Definitions and Waveforms

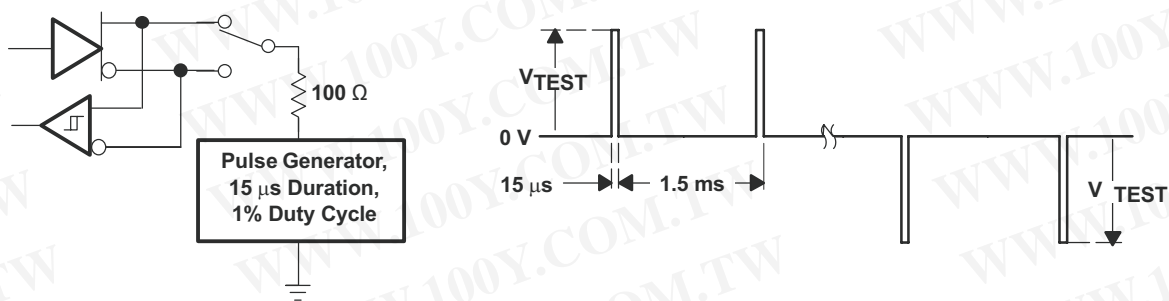
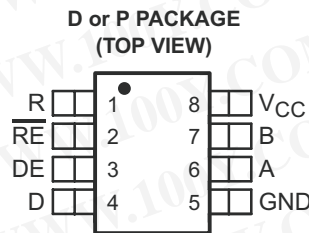
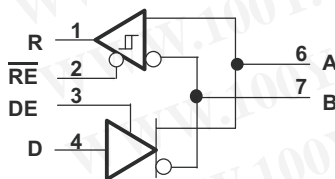

Figure 16. Test Circuit and Waveforms, Transient Overvoltage Test

PIN ASSIGNMENTS



LOGIC DIAGRAM



勝特力材料 886-3-5753170
 勝特力电子(上海) 86-21-34970699
 勝特力电子(深圳) 86-755-83298787
 Http://www.100y.com.tw

THERMAL INFORMATION

THERMAL METRIC ⁽¹⁾	SN65HVD2x		UNITS
	SOIC (D)	PDIP (P)	
	8 PINS	PINS	
θ_{JA} Junction-to-ambient thermal resistance ⁽²⁾	78.1	52.5	°C/W
$\theta_{JC(top)}$ Junction-to-case(top) thermal resistance ⁽³⁾	56.5	57.6	
θ_{JB} Junction-to-board thermal resistance ⁽⁴⁾	50.4	38.6	
ψ_{JT} Junction-to-top characterization parameter ⁽⁵⁾	4.1	19.1	
ψ_{JB} Junction-to-board characterization parameter ⁽⁶⁾	32.6	31.9	
$\theta_{JC(bottom)}$ Junction-to-case(bottom) thermal resistance ⁽⁷⁾	nA	n/A	

- (1) For more information about traditional and new thermal metrics, see the *IC Package Thermal Metrics* application report, [SPRA953](#).
- (2) The junction-to-ambient thermal resistance under natural convection is obtained in a simulation on a JEDEC-standard, high-K board, as specified in JESD51-7, in an environment described in JESD51-2a.
- (3) The junction-to-case (top) thermal resistance is obtained by simulating a cold plate test on the package top. No specific JEDEC-standard test exists, but a close description can be found in the ANSI SEMI standard G30-88.
- (4) The junction-to-board thermal resistance is obtained by simulating in an environment with a ring cold plate fixture to control the PCB temperature, as described in JESD51-8.
- (5) The junction-to-top characterization parameter, ψ_{JT} , estimates the junction temperature of a device in a real system and is extracted from the simulation data for obtaining θ_{JA} , using a procedure described in JESD51-2a (sections 6 and 7).
- (6) The junction-to-board characterization parameter, ψ_{JB} , estimates the junction temperature of a device in a real system and is extracted from the simulation data for obtaining θ_{JA} , using a procedure described in JESD51-2a (sections 6 and 7).
- (7) The junction-to-case (bottom) thermal resistance is obtained by simulating a cold plate test on the exposed (power) pad. No specific JEDEC standard test exists, but a close description can be found in the ANSI SEMI standard G30-88.

POWER DISSIPATION

PARAMETERS			TEST CONDITIONS	VALUE	UNIT	
Device Power dissipation, P_D	Typical	HVD20	$V_{CC} = 5\text{ V}$, $T_J = 25^\circ\text{C}$, $R_L = 54\ \Omega$, $C_L = 50\ \text{pF}$ (driver), $C_L = 15\ \text{pF}$ (receiver), 50% Duty cycle square-wave signal, Driver and receiver enabled	25 Mbps	295	mW
		HVD21		5 Mbps	260	
		HVD22		500 kbps	233	
		HVD23		25 Mbps	302	
		HVD24		5 Mbps	267	
	Worst case	HVD20	$V_{CC} = 5.5\ \text{V}$, $T_J = 125^\circ\text{C}$, $R_L = 54\ \Omega$, $C_L = 50\ \text{pF}$, $C_L = 15\ \text{pF}$ (receiver), 50% Duty cycle square-wave signal, Driver and receiver enabled	25 Mbps	408	mW
		HVD21		5 Mbps	342	
		HVD22		500 kbps	300	
		HVD23		25 Mbps	417	
		HVD24		5 Mbps	352	
Thermal shut down junction temperature, T_{SD}				170	°C	

勝特力材料 886-3-5753170
 勝特力电子(上海) 86-21-34970699
 勝特力电子(深圳) 86-755-83298787
[Http://www.100y.com.tw](http://www.100y.com.tw)

TYPICAL CHARACTERISTICS

HVD20, HVD23
BUS PIN CURRENT
vs
BUS PIN VOLTAGE

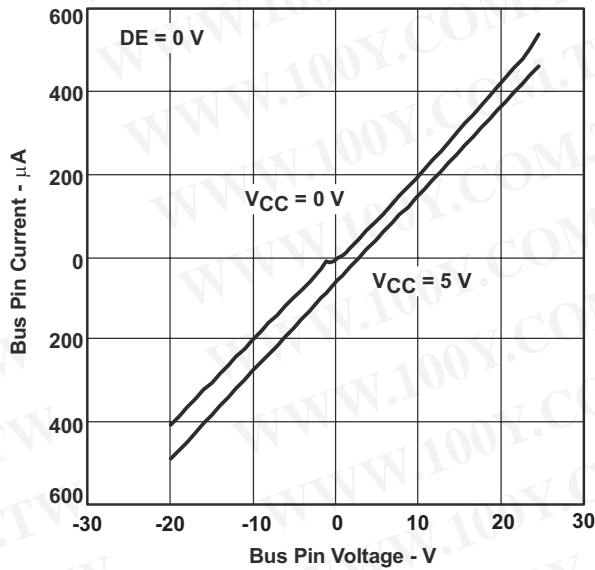

Figure 17.

HVD21, HVD22, HVD24
BUS PIN CURRENT
vs
BUS PIN VOLTAGE

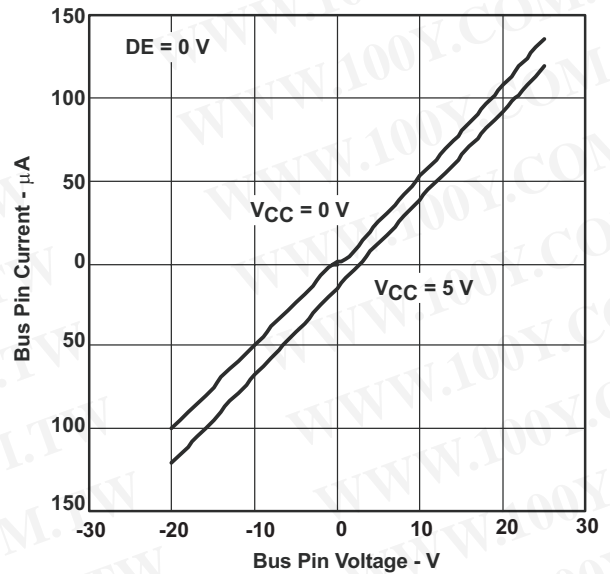

Figure 18.

SUPPLY CURRENT
vs
SIGNALING RATE

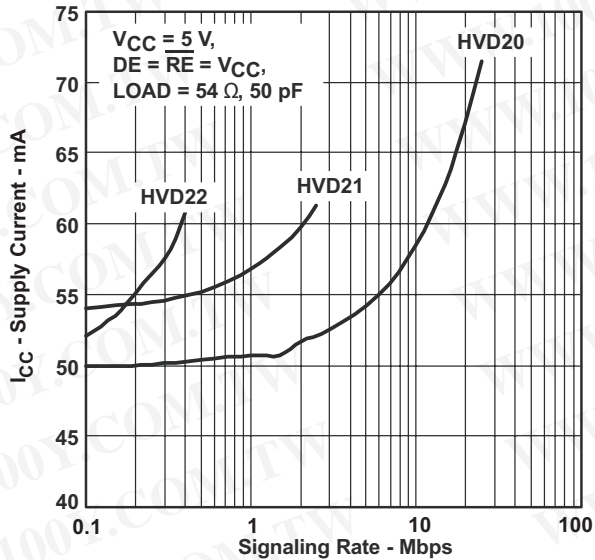

Figure 19.

DRIVER DIFFERENTIAL OUTPUT VOLTAGE
vs
DRIVER LOAD CURRENT

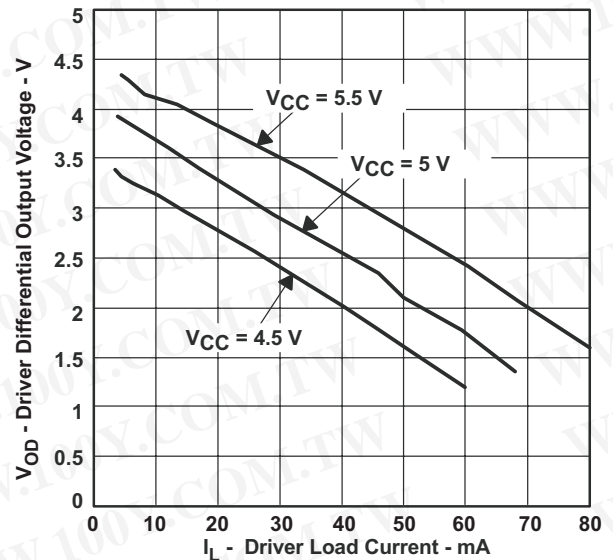

Figure 20.

勝特力材料 886-3-5753170
勝特力电子(上海) 86-21-34970699
勝特力电子(深圳) 86-755-83298787
[Http://www.100y.com.tw](http://www.100y.com.tw)

TYPICAL CHARACTERISTICS (continued)

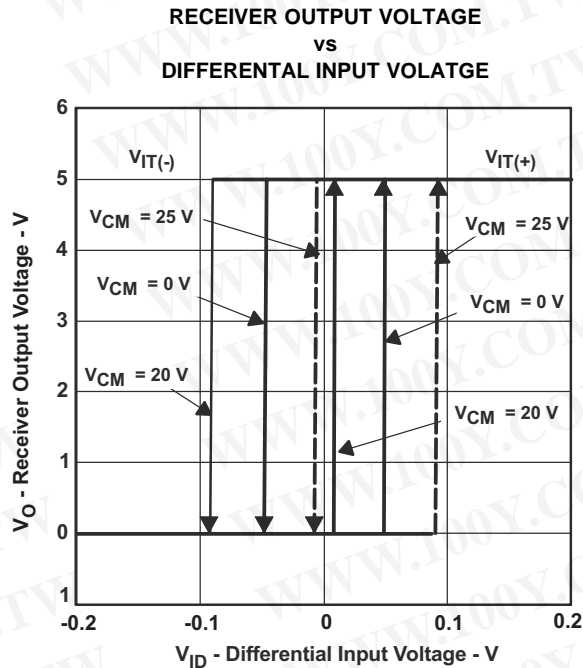

Figure 21.

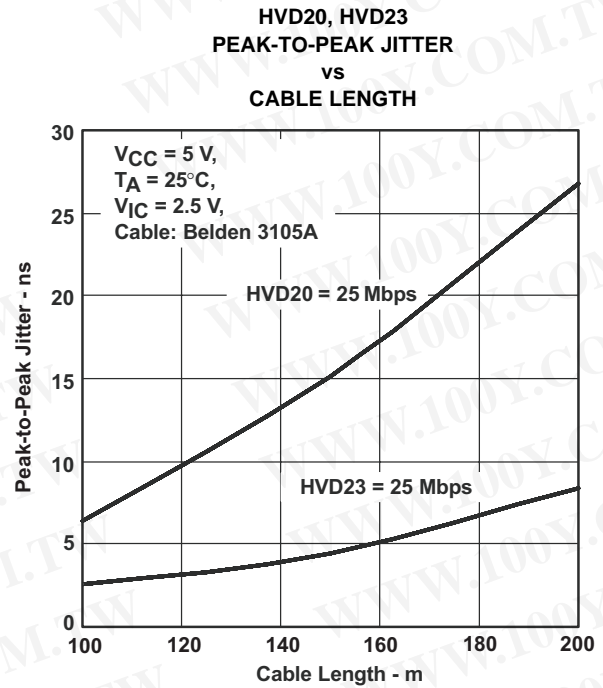

Figure 22.

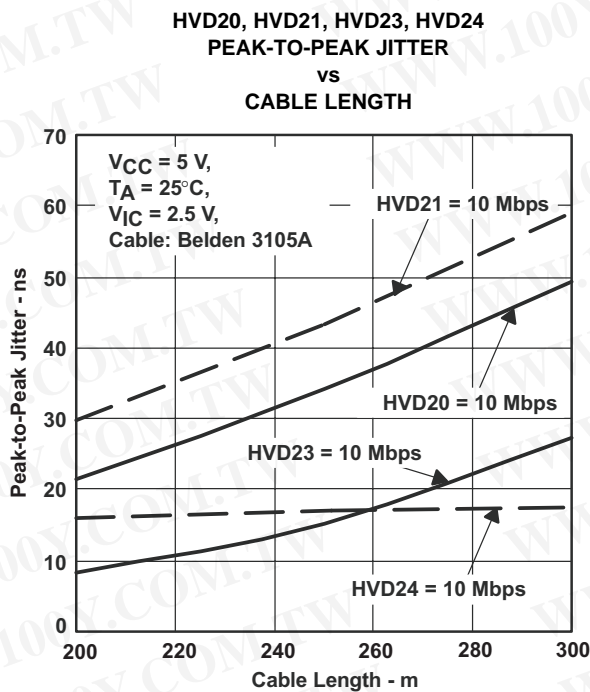

Figure 23.

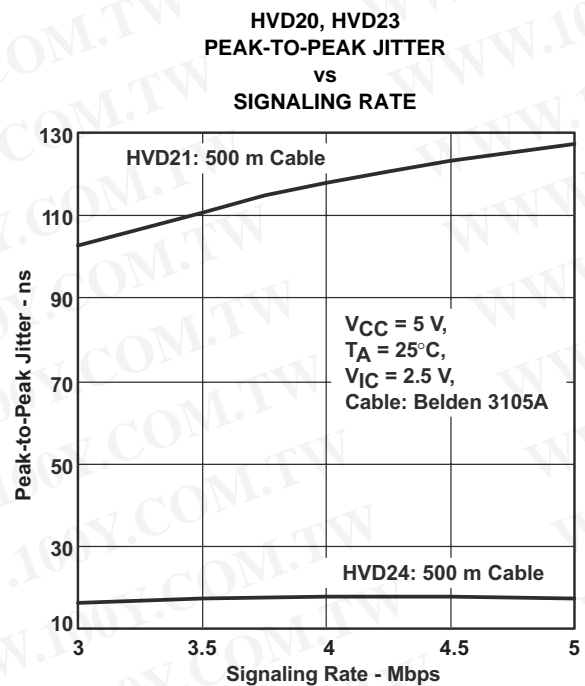

Figure 24.

勝特力材料 886-3-5753170
勝特力电子(上海) 86-21-34970699
勝特力电子(深圳) 86-755-83298787
[Http://www.100y.com.tw](http://www.100y.com.tw)

APPLICATION INFORMATION

THEORY OF OPERATION

The HVD2x family of devices integrates a differential receiver and differential driver with additional features for improved performance in electrically-noisy, long-cable, or other fault-intolerant applications.

The receiver hysteresis (typically 130 mV) is much larger than found in typical RS-485 transceivers. This helps reject spurious noise signals which would otherwise cause false changes in the receiver output state.

Slew rate limiting on the driver outputs (SN65HVD21, 22, and 24) reduces the high-frequency content of signal edges. This decreases reflections from bus discontinuities, and allows longer stub lengths between nodes and the main bus line. Designers should consider the maximum signaling rate and cable length required for a specific application, and choose the transceiver best matching those requirements.

When DE is low, the differential driver is disabled, and the A and B outputs are in high-impedance states. When DE is high, the differential driver is enabled, and drives the A and B outputs according to the state of the D input.

When \overline{RE} is high, the differential receiver output buffer is disabled, and the R output is in a high-impedance state. When \overline{RE} is low, the differential receiver is enabled, and the R output reflects the state of the differential bus inputs on the A and B pins.

If both the driver and receiver are disabled, (DE low and \overline{RE} high) then all nonessential circuitry, including auxiliary functions such as failsafe and receiver equalization is placed in a low-power standby state. This reduces power consumption to less than 5µW. When either enable input is asserted, the circuitry again becomes active.

In addition to the primary differential receiver, these devices incorporate a set of comparators and logic to implement an active receiver failsafe feature. These components determine whether the differential bus signal is valid. Whenever the differential signal is close to zero volts (neither high nor low), a timer initiates. If the differential input remains within the transition range for more than 250 microseconds, the timer expires and set the receiver output to the high state. If a valid bus input (high or low) is received at any time, the receiver output reflects the valid bus state, and the timer is reset.

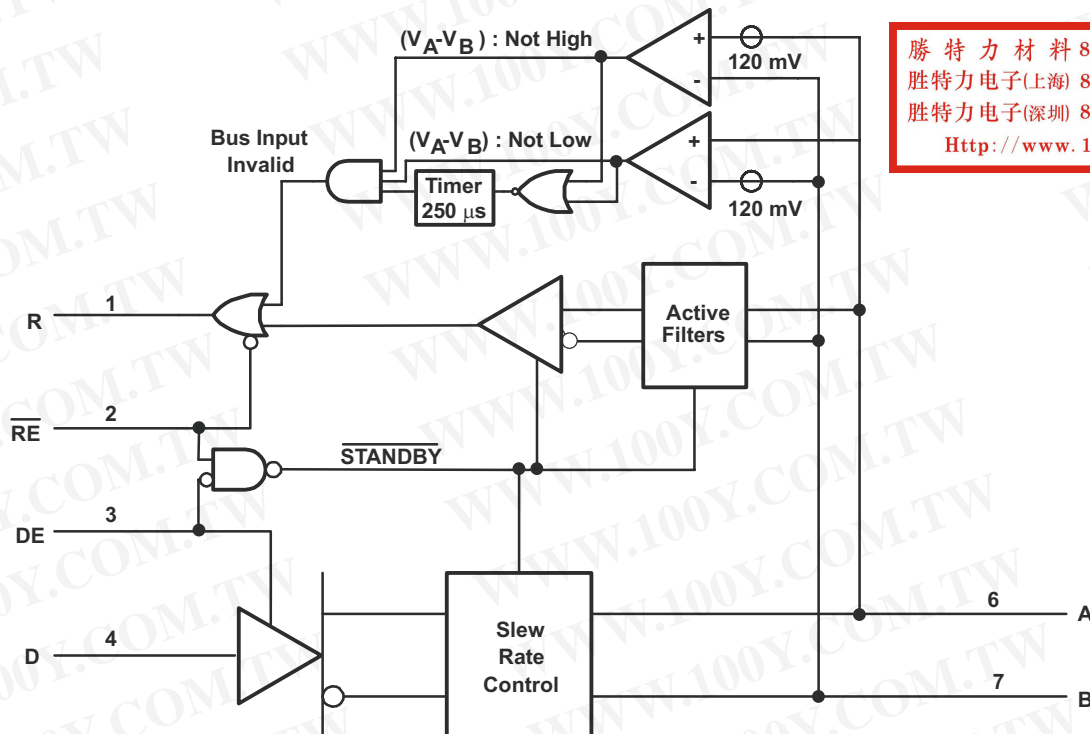

勝特力材料 886-3-5753170
勝特力电子(上海) 86-21-34970699
勝特力电子(深圳) 86-755-83298787
[Http://www.100y.com.tw](http://www.100y.com.tw)

Figure 25. Function Block Diagram

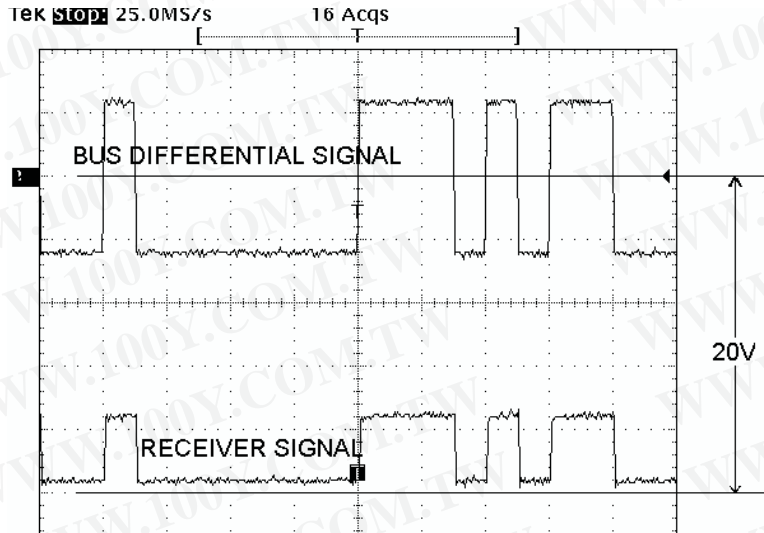

Figure 26. HVD22 Receiver Operation With 20-V Offset on Input Signal

$H(s) = k_0 \left[(1-k_1) + \frac{k_1 p_1}{(s+p_1)} \right] \left[(1-k_2) + \frac{k_2 p_2}{(s+p_2)} \right] \left[(1-k_3) + \frac{k_3 p_3}{(s+p_3)} \right]$	k0 (DC loss)	p1 (MHz)	k1	p2 (MHz)	k2	p3 (MHz)	k3
Similar to 160m of Belden 3105A	0.95	0.25	0.3	3.5	0.5	15	1
Similar to 250m of Belden 3105A	0.9	0.25	0.4	3.5	0.7	12	1
Similar to 500m of Belden 3105A	0.8	0.25	0.6	2.2	1	8	1
Similar to 1000m of Belden 3105A	0.6	0.3	1	3	1	6	1

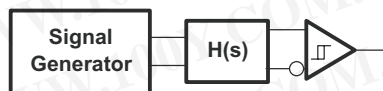

Figure 27. Cable Attenuation Model for Jitter Measurements

勝特力材料 886-3-5753170
 勝特力电子(上海) 86-21-34970699
 勝特力电子(深圳) 86-755-83298787
[Http://www.100y.com.tw](http://www.100y.com.tw)

INTEGRATED RECEIVER EQUALIZATION USING THE HVD23

Figure 28 illustrates the benefits of integrated receiver equalization as implemented in the HVD23 transceiver. In this test setup, a differential signal generator applied a signal voltage at one end of the cable, which was Belden 3105A twisted-pair shielded cable. The test signal was a pseudo-random bit stream (PRBS) of nonreturn-to-zero (NRZ) data. Channel 1 (top) shows the eye-pattern of the differential voltage at the receiver inputs (after the cable attenuation). Channel 2 (bottom) shows the output of the receiver.

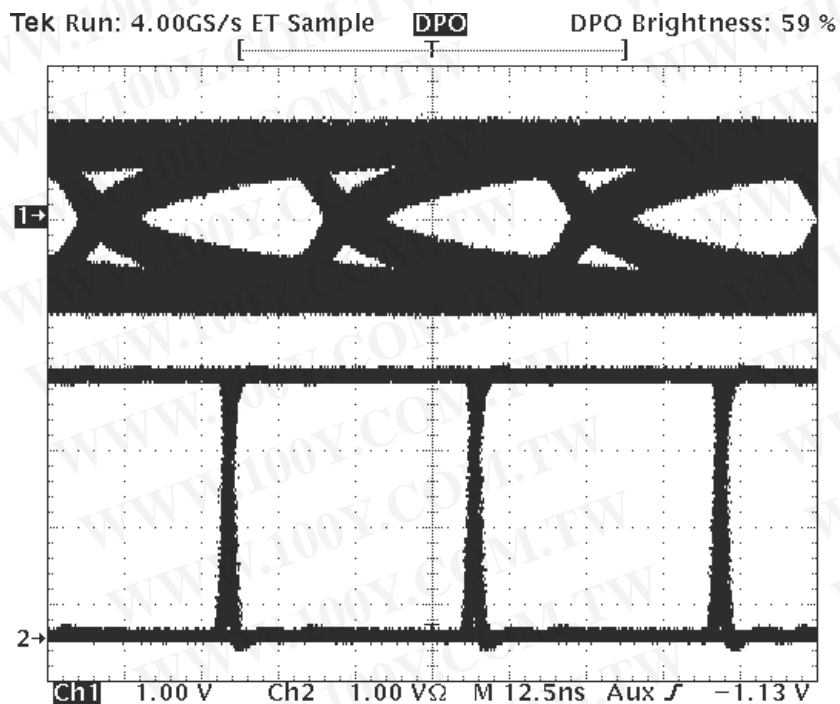

Figure 28. HVD23 Receiver Performance at 25 Mbps Over 150 Meter Cable

勝特力材料 886-3-5753170
 勝特力电子(上海) 86-21-34970699
 勝特力电子(深圳) 86-755-83298787
[Http://www.100y.com.tw](http://www.100y.com.tw)

INTEGRATED RECEIVER EQUALIZATION USING THE HVD24

Figure 29 illustrates the benefits of integrated receiver equalization as implemented in the HVD24 transceiver. In this test setup, a differential signal generator applied a signal voltage at one end of the cable, which was Belden 3105A twisted-pair shielded cable. The test signal was a pseudo-random bit stream (PRBS) of nonreturn-to-zero (NRZ) data. Channel 1 (top) shows the eye-pattern of the bit stream. Channel 2 (middle) shows the eye-pattern of the differential voltage at the receiver inputs (after the cable attenuation). Channel 3 (bottom) shows the output of the receiver.

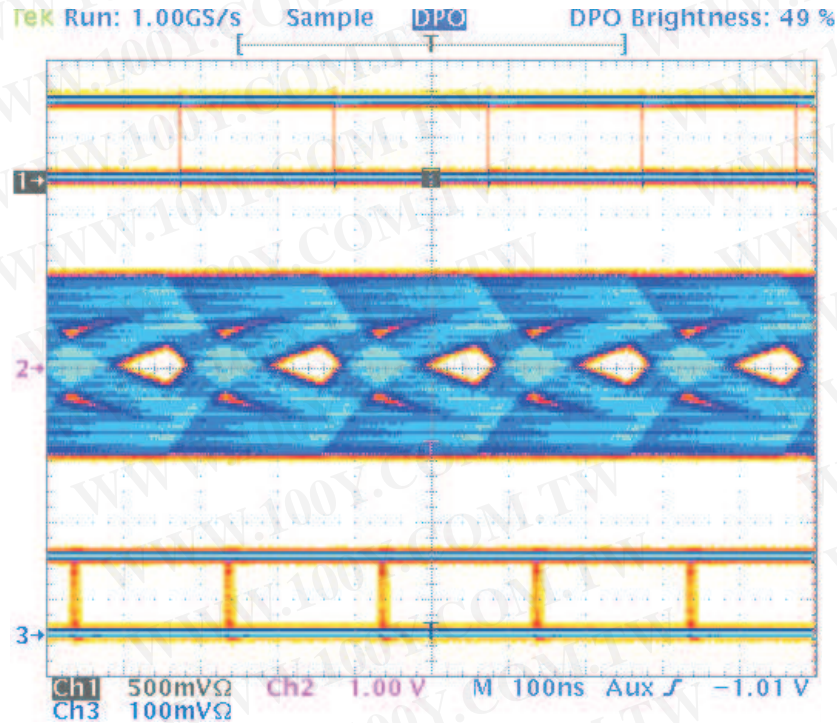

Figure 29. HVD24 Receiver Performance at 5 Mbps Over 500 Meter Cable

勝特力材料 886-3-5753170
勝特力电子(上海) 86-21-34970699
勝特力电子(深圳) 86-755-83298787
[Http://www.100y.com.tw](http://www.100y.com.tw)

NOISE CONSIDERATIONS FOR EQUALIZED RECEIVERS

The simplest way of overcoming the effects of cable losses is to increase the sensitivity of the receiver. If the maximum attenuation of frequencies of interest is 20 dB, increasing the receiver gain by a factor of ten compensates for the cable. However, this means that both signal and noise are amplified. Therefore, the receiver with higher gain is more sensitive to noise and it is important to minimize differential noise coupling to the equalized receiver.

Differential noise is created when conducted or radiated noise energy generates more voltage on one line of the differential pair than the other. For this to occur from conducted or electric far-field noise, the impedance to ground of the lines must differ.

For noise frequency out to 50 MHz, the input traces can be treated as a lumped capacitance if the receiver is approximately 10 inches or less from the connector. Therefore, matching impedance of the lines is accomplished by matching the lumped capacitance of each.

The primary factors that affect the capacitance of a trace are in length, thickness, width, dielectric material, distance from the signal return path, stray capacitance, and proximity to other conductors. It is difficult to match each of the variables for each line of the differential pair exactly, but a reasonable effort to do so keeps the lines balanced and less susceptible to differential noise coupling.

Another source of differential noise is from near-field coupling. In this situation, an assumption of equal noise-source impedance cannot be made as in the far-field. Familiarly known as crosstalk, more energy from a nearby signal is coupled to one line of the differential pair. Minimization of this differential noise is accomplished by keeping the signal pair close together and physical separation from high-voltage, high-current, or high-frequency signals.

In summary, follow these guidelines in board layout for keeping differential noise to a minimum.

- Keep the differential input traces short.
- Match the length, physical dimensions, and routing of each line of the pair.
- Keep the lines close together.
- Match components connected to each line.
- Separate the inputs from high-voltage, high-frequency, or high-current signals.

勝特力材料 886-3-5753170
勝特力电子(上海) 86-21-34970699
勝特力电子(深圳) 86-755-83298787
[Http://www.100y.com.tw](http://www.100y.com.tw)

TEST MODE DRIVER DISABLE

If the input signal to the D pin is such that:

1. the signal has signaling rate above 4 Mbps (for the 'HVD21 and 'HVD24)
2. the signal has signaling rate above 6 Mbps (for the 'HVD20 and 'HVD23)
3. the signal has average amplitude between 1.2 V and 1.6 V (1.4 V \pm 200 mV)
4. the average signal amplitude remains in this range for 100 μ sec or longer,

then the driver may activate a test-mode during which the driver outputs are temporarily disabled. This can cause loss of transmission of data during the period that the device is in the test-mode. The driver will be re-enabled and resume normal operation whenever the above conditions are not true. The device is not damaged by this test mode.

Although rare, there are combinations of specific voltage levels and input data patterns within the operating conditions of the HVD2x family which may lead to a temporary state where the driver outputs are disabled for a period of time.

Observations:

1. The conditions for inadvertently entering the test mode are dependent on the levels, duration, and duty cycle of the logic signal input to the D pin. Operating input levels are specified as greater than 2 V for a logic HIGH input, and less than 0.8V for a logic LOW input. Therefore, a valid steady-state logic input will not cause the device to activate the test mode
2. Only input signals with frequency content above 2 MHz (4 Mbps) have a possibility of activating the test mode. Therefore, this issue should not affect the normal operation of the HVD22 (500 kbps).
3. For operating signaling rates of 4 Mbps (or above), the conditions stated above must remain true over a period of: 4 Mbps x 100 μ sec = 400 bits. Therefore, a normal short message will not inadvertently activate the test mode
4. One example of an input signal which may cause the test mode to activate is a clock signal with frequency 3 MHz and 50% duty cycle (symmetric HIGH and LOW half-cycles) with logic HIGH levels of 2.4 V and logic LOW levels of 0.4 V. This signal applied to the D pin as a driver input would meet the criteria listed above, and might cause the test-mode to activate, which would disable the driver. Note that this example situation might occur if the clock signal were generated by a microcontroller or logic chip with a 2.7 V-supply.

勝特力材料 886-3-5753170
勝特力电子(上海) 86-21-34970699
勝特力电子(深圳) 86-755-83298787
[Http://www.100y.com.tw](http://www.100y.com.tw)

REVISION HISTORY

Changes from Original (December 2002) to Revision A

Page

- Changed t_{PZH} , t_{PHZ} , t_{PZL} , and t_{PLZ} - From a MAX value of 120 To include TYP and MAX values for each entry (RECEIVER SWITCHING CHARACTERISTICS table) **6**

Changes from Revision A (March 2003) to Revision B

Page

- Added V_{IK} TYP Value of 0.75V (DRIVER ELECTRICAL CHARACTERISTICS table) **4**
- Deleted $V_{IT(F+)}$ - VCM = -20 V to 25 V MIN value (RECEIVER ELECTRICAL CHARACTERISTICS table) **5**
- Added RECEIVER EQUALIZATION CHARACTERISTICS table **6**
- Changed A Input circuit in the EQUIVALENT INPUT AND OUTPUT SCHEMATIC DIAGRAMS **8**
- Added [Figure 22](#), [Figure 23](#), and [Figure 24](#) to the TYPICAL CHARACTERISTICS **15**
- Changed the INTEGRATED RECEIVER EQUALIZATION USING THE HVD23 section **19**
- Changed the INTEGRATED RECEIVER EQUALIZATION USING THE HVD24 section **20**

Changes from Revision B (June 2003) to Revision C

Page

- Added the THERMAL CHARACTERISTICS table **14**
- Added the THEORY OF OPERATION section **17**
- Added the NOISE CONSIDERATIONS FOR EQUALIZED RECEIVERS section **21**

Changes from Revision C (September 2003) to Revision D

Page

- Added Conditions note to the ABSOLUTE MAXIMUM RATINGS table "over operating free-air temperature range (unless otherwise noted)" **3**
- Deleted Storage temperature, T_{stg} from the ABSOLUTE MAXIMUM RATINGS table **3**
- Added Receiver output current, I_O to the ABSOLUTE MAXIMUM RATINGS table **3**

Changes from Revision D (April 2005) to Revision E

Page

- Changed I_O - Added test condition and values per device number (DRIVER ELECTRICAL CHARACTERISTICS table) **4**
- Replaced the Dissipation Rating table with the THERMAL INFORMATION table **14**
- Changed the THERMAL CHARACTERISTICS table to POWER DISSIPATION table **14**
- Added the TEST MODE DRIVER DISABLE section **22**

勝特力材料 886-3-5753170
 勝特力电子(上海) 86-21-34970699
 勝特力电子(深圳) 86-755-83298787
[Http://www.100y.com.tw](http://www.100y.com.tw)

PACKAGING INFORMATION

Orderable Device	Status ⁽¹⁾	Package Type	Package Drawing	Pins	Package Qty	Eco Plan ⁽²⁾	Lead/Ball Finish	MSL Peak Temp ⁽³⁾
SN65HVD20D	ACTIVE	SOIC	D	8	75	Green (RoHS & no Sb/Br)	CU NIPDAU	Level-1-260C-UNLIM
SN65HVD20DG4	ACTIVE	SOIC	D	8	75	Green (RoHS & no Sb/Br)	CU NIPDAU	Level-1-260C-UNLIM
SN65HVD20DR	ACTIVE	SOIC	D	8	2500	Green (RoHS & no Sb/Br)	CU NIPDAU	Level-1-260C-UNLIM
SN65HVD20DRG4	ACTIVE	SOIC	D	8	2500	Green (RoHS & no Sb/Br)	CU NIPDAU	Level-1-260C-UNLIM
SN65HVD20P	ACTIVE	PDIP	P	8	50	Pb-Free (RoHS)	CU NIPDAU	N / A for Pkg Type
SN65HVD20PE4	ACTIVE	PDIP	P	8	50	Pb-Free (RoHS)	CU NIPDAU	N / A for Pkg Type
SN65HVD21D	ACTIVE	SOIC	D	8	75	Green (RoHS & no Sb/Br)	CU NIPDAU	Level-1-260C-UNLIM
SN65HVD21DG4	ACTIVE	SOIC	D	8	75	Green (RoHS & no Sb/Br)	CU NIPDAU	Level-1-260C-UNLIM
SN65HVD21DR	ACTIVE	SOIC	D	8	2500	Green (RoHS & no Sb/Br)	CU NIPDAU	Level-1-260C-UNLIM
SN65HVD21DRG4	ACTIVE	SOIC	D	8	2500	Green (RoHS & no Sb/Br)	CU NIPDAU	Level-1-260C-UNLIM
SN65HVD21P	ACTIVE	PDIP	P	8	50	Pb-Free (RoHS)	CU NIPDAU	N / A for Pkg Type
SN65HVD21PE4	ACTIVE	PDIP	P	8	50	Pb-Free (RoHS)	CU NIPDAU	N / A for Pkg Type
SN65HVD22D	ACTIVE	SOIC	D	8	75	Green (RoHS & no Sb/Br)	CU NIPDAU	Level-1-260C-UNLIM
SN65HVD22DG4	ACTIVE	SOIC	D	8	75	Green (RoHS & no Sb/Br)	CU NIPDAU	Level-1-260C-UNLIM
SN65HVD22DR	ACTIVE	SOIC	D	8	2500	Green (RoHS & no Sb/Br)	CU NIPDAU	Level-1-260C-UNLIM
SN65HVD22DRG4	ACTIVE	SOIC	D	8	2500	Green (RoHS & no Sb/Br)	CU NIPDAU	Level-1-260C-UNLIM
SN65HVD22P	ACTIVE	PDIP	P	8	50	Pb-Free (RoHS)	CU NIPDAU	N / A for Pkg Type
SN65HVD22PE4	ACTIVE	PDIP	P	8	50	Pb-Free (RoHS)	CU NIPDAU	N / A for Pkg Type
SN65HVD23D	ACTIVE	SOIC	D	8	75	Green (RoHS & no Sb/Br)	CU NIPDAU	Level-1-260C-UNLIM
SN65HVD23DG4	ACTIVE	SOIC	D	8	75	Green (RoHS & no Sb/Br)	CU NIPDAU	Level-1-260C-UNLIM
SN65HVD23DR	ACTIVE	SOIC	D	8	2500	Green (RoHS & no Sb/Br)	CU NIPDAU	Level-1-260C-UNLIM
SN65HVD23DRG4	ACTIVE	SOIC	D	8	2500	Green (RoHS & no Sb/Br)	CU NIPDAU	Level-1-260C-UNLIM
SN65HVD23P	ACTIVE	PDIP	P	8	50	Pb-Free (RoHS)	CU NIPDAU	N / A for Pkg Type
SN65HVD23PE4	ACTIVE	PDIP	P	8	50	Pb-Free (RoHS)	CU NIPDAU	N / A for Pkg Type
SN65HVD24D	ACTIVE	SOIC	D	8	75	Green (RoHS & no Sb/Br)	CU NIPDAU	Level-1-260C-UNLIM

勝特力材料 886-3-5753170
勝特力电子(上海) 86-21-34970699
勝特力电子(深圳) 86-755-83298787
[Http://www.100y.com.tw](http://www.100y.com.tw)

Orderable Device	Status ⁽¹⁾	Package Type	Package Drawing	Pins	Package Qty	Eco Plan ⁽²⁾	Lead/Ball Finish	MSL Peak Temp ⁽³⁾
SN65HVD24DG4	ACTIVE	SOIC	D	8	75	Green (RoHS & no Sb/Br)	CU NIPDAU	Level-1-260C-UNLIM
SN65HVD24DR	ACTIVE	SOIC	D	8	2500	Green (RoHS & no Sb/Br)	CU NIPDAU	Level-1-260C-UNLIM
SN65HVD24DRG4	ACTIVE	SOIC	D	8	2500	Green (RoHS & no Sb/Br)	CU NIPDAU	Level-1-260C-UNLIM
SN65HVD24P	ACTIVE	PDIP	P	8	50	Pb-Free (RoHS)	CU NIPDAU	N / A for Pkg Type
SN65HVD24PE4	ACTIVE	PDIP	P	8	50	Pb-Free (RoHS)	CU NIPDAU	N / A for Pkg Type

⁽¹⁾ The marketing status values are defined as follows:

ACTIVE: Product device recommended for new designs.

LIFEBUY: TI has announced that the device will be discontinued, and a lifetime-buy period is in effect.

NRND: Not recommended for new designs. Device is in production to support existing customers, but TI does not recommend using this part in a new design.

PREVIEW: Device has been announced but is not in production. Samples may or may not be available.

OBsolete: TI has discontinued the production of the device.

⁽²⁾ Eco Plan - The planned eco-friendly classification: Pb-Free (RoHS), Pb-Free (RoHS Exempt), or Green (RoHS & no Sb/Br) - please check <http://www.ti.com/productcontent> for the latest availability information and additional product content details.

TBD: The Pb-Free/Green conversion plan has not been defined.

Pb-Free (RoHS): TI's terms "Lead-Free" or "Pb-Free" mean semiconductor products that are compatible with the current RoHS requirements for all 6 substances, including the requirement that lead not exceed 0.1% by weight in homogeneous materials. Where designed to be soldered at high temperatures, TI Pb-Free products are suitable for use in specified lead-free processes.

Pb-Free (RoHS Exempt): This component has a RoHS exemption for either 1) lead-based flip-chip solder bumps used between the die and package, or 2) lead-based die adhesive used between the die and leadframe. The component is otherwise considered Pb-Free (RoHS compatible) as defined above.

Green (RoHS & no Sb/Br): TI defines "Green" to mean Pb-Free (RoHS compatible), and free of Bromine (Br) and Antimony (Sb) based flame retardants (Br or Sb do not exceed 0.1% by weight in homogeneous material)

⁽³⁾ MSL, Peak Temp. -- The Moisture Sensitivity Level rating according to the JEDEC industry standard classifications, and peak solder temperature.

Important Information and Disclaimer: The information provided on this page represents TI's knowledge and belief as of the date that it is provided. TI bases its knowledge and belief on information provided by third parties, and makes no representation or warranty as to the accuracy of such information. Efforts are underway to better integrate information from third parties. TI has taken and continues to take reasonable steps to provide representative and accurate information but may not have conducted destructive testing or chemical analysis on incoming materials and chemicals. TI and TI suppliers consider certain information to be proprietary, and thus CAS numbers and other limited information may not be available for release.

In no event shall TI's liability arising out of such information exceed the total purchase price of the TI part(s) at issue in this document sold by TI to Customer on an annual basis.

勝特力材料 886-3-5753170
 勝特力电子(上海) 86-21-34970699
 勝特力电子(深圳) 86-755-83298787
[Http://www.100y.com.tw](http://www.100y.com.tw)

TAPE AND REEL INFORMATION

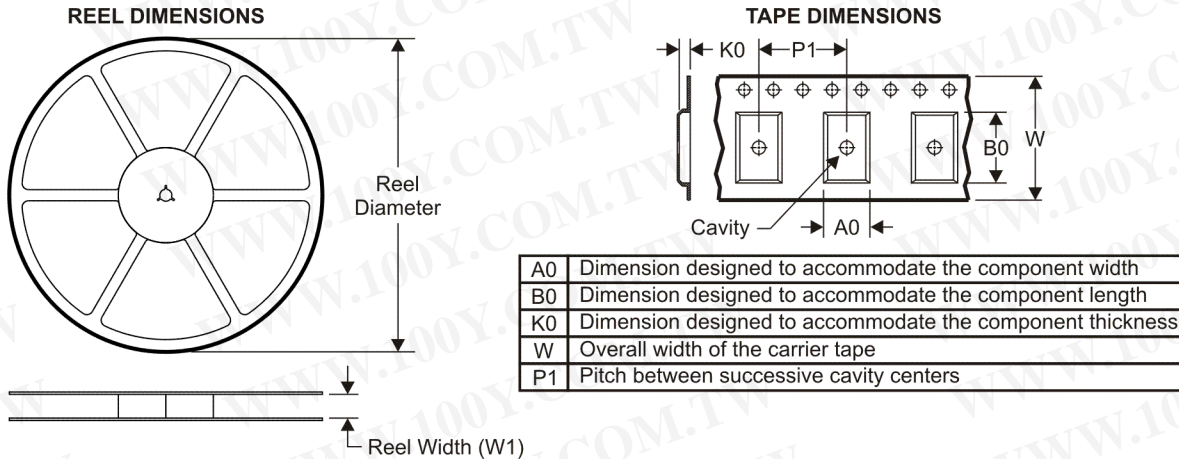

QUADRANT ASSIGNMENTS FOR PIN 1 ORIENTATION IN TAPE

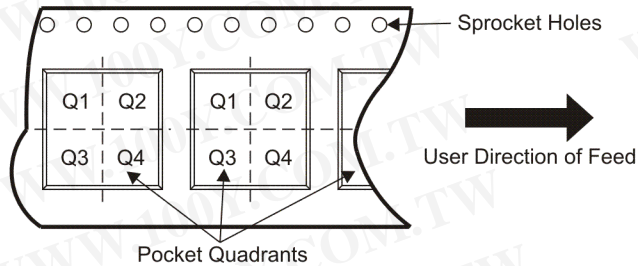

*All dimensions are nominal

Device	Package Type	Package Drawing	Pins	SPQ	Reel Diameter (mm)	Reel Width W1 (mm)	A0 (mm)	B0 (mm)	K0 (mm)	P1 (mm)	W (mm)	Pin1 Quadrant
SN65HVD20DR	SOIC	D	8	2500	330.0	12.4	6.4	5.2	2.1	8.0	12.0	Q1
SN65HVD21DR	SOIC	D	8	2500	330.0	12.4	6.4	5.2	2.1	8.0	12.0	Q1
SN65HVD22DR	SOIC	D	8	2500	330.0	12.4	6.4	5.2	2.1	8.0	12.0	Q1
SN65HVD23DR	SOIC	D	8	2500	330.0	12.4	6.4	5.2	2.1	8.0	12.0	Q1
SN65HVD24DR	SOIC	D	8	2500	330.0	12.4	6.4	5.2	2.1	8.0	12.0	Q1

勝特力材料 886-3-5753170
 勝特力电子(上海) 86-21-34970699
 勝特力电子(深圳) 86-755-83298787
[Http://www.100y.com.tw](http://www.100y.com.tw)

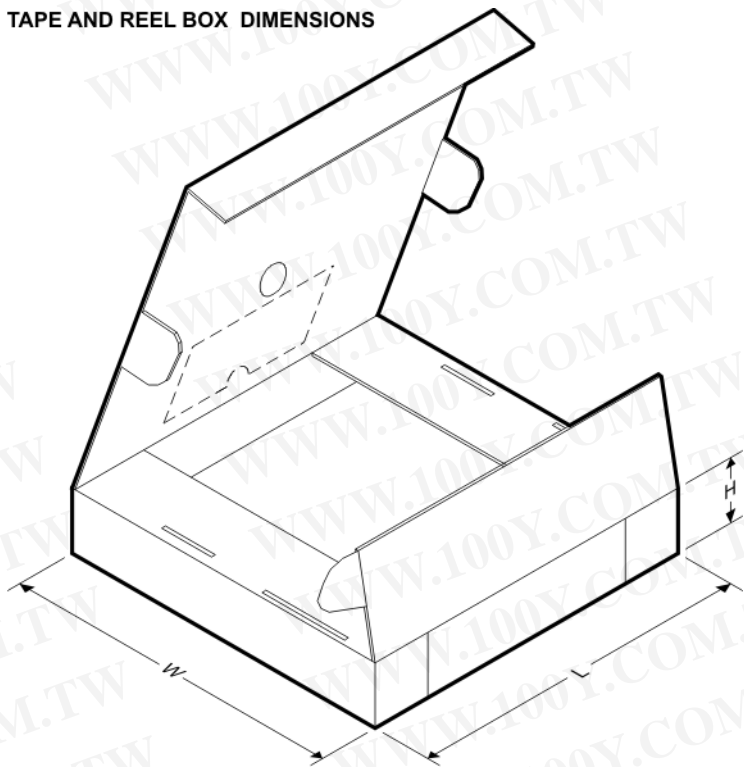
TAPE AND REEL BOX DIMENSIONS

*All dimensions are nominal

Device	Package Type	Package Drawing	Pins	SPQ	Length (mm)	Width (mm)	Height (mm)
SN65HVD20DR	SOIC	D	8	2500	340.5	338.1	20.6
SN65HVD21DR	SOIC	D	8	2500	340.5	338.1	20.6
SN65HVD22DR	SOIC	D	8	2500	340.5	338.1	20.6
SN65HVD23DR	SOIC	D	8	2500	340.5	338.1	20.6
SN65HVD24DR	SOIC	D	8	2500	340.5	338.1	20.6

勝特力材料 886-3-5753170
勝特力电子(上海) 86-21-34970699
勝特力电子(深圳) 86-755-83298787
[Http://www.100y.com.tw](http://www.100y.com.tw)

P (R-PDIP-T8)

PLASTIC DUAL-IN-LINE PACKAGE

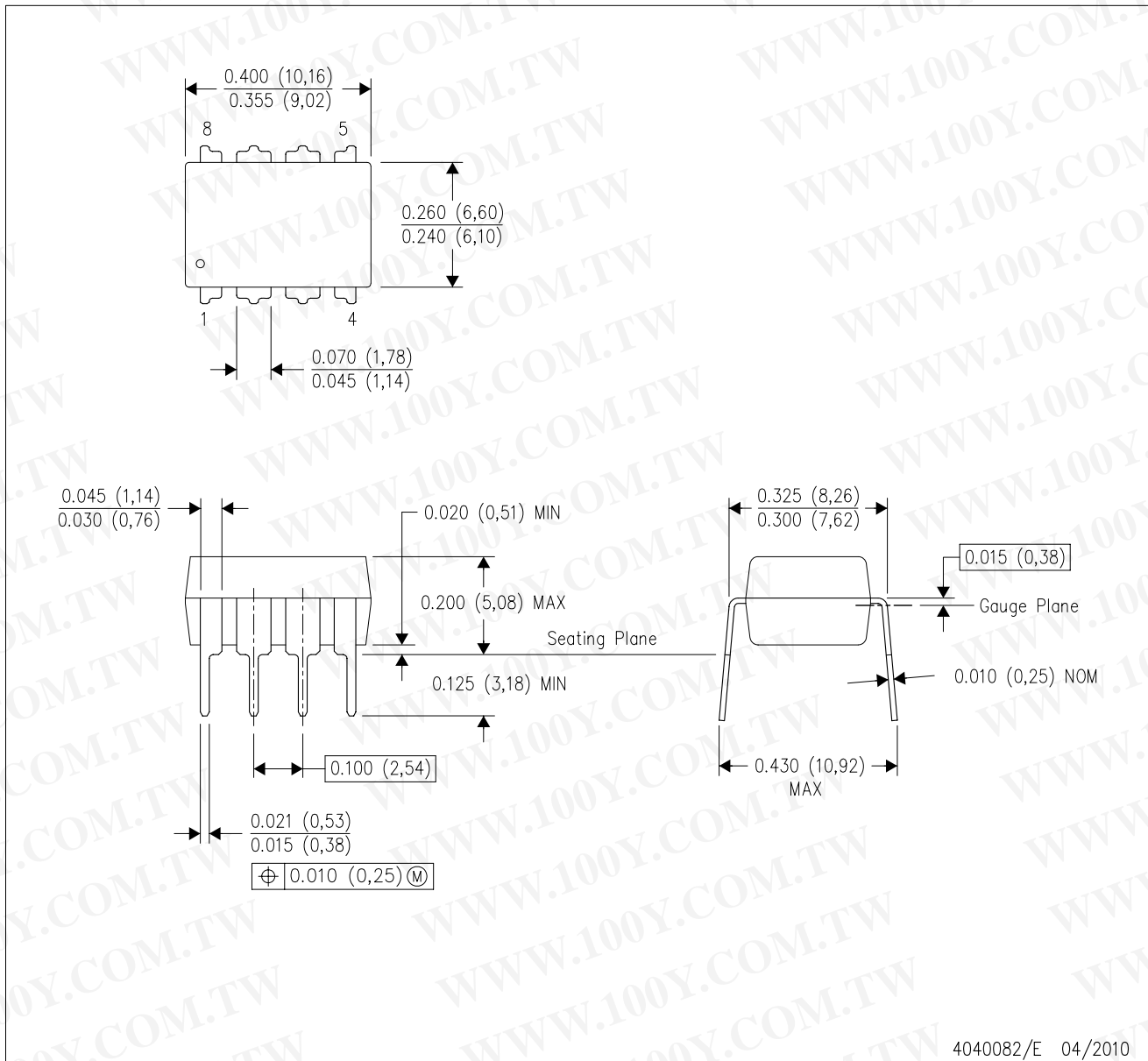

- NOTES:
- A. All linear dimensions are in inches (millimeters).
 - B. This drawing is subject to change without notice.
 - C. Falls within JEDEC MS-001 variation BA.

勝特力材料 886-3-5753170
勝特力电子(上海) 86-21-34970699
勝特力电子(深圳) 86-755-83298787
[Http://www.100y.com.tw](http://www.100y.com.tw)

D (R-PDSO-G8)

PLASTIC SMALL OUTLINE

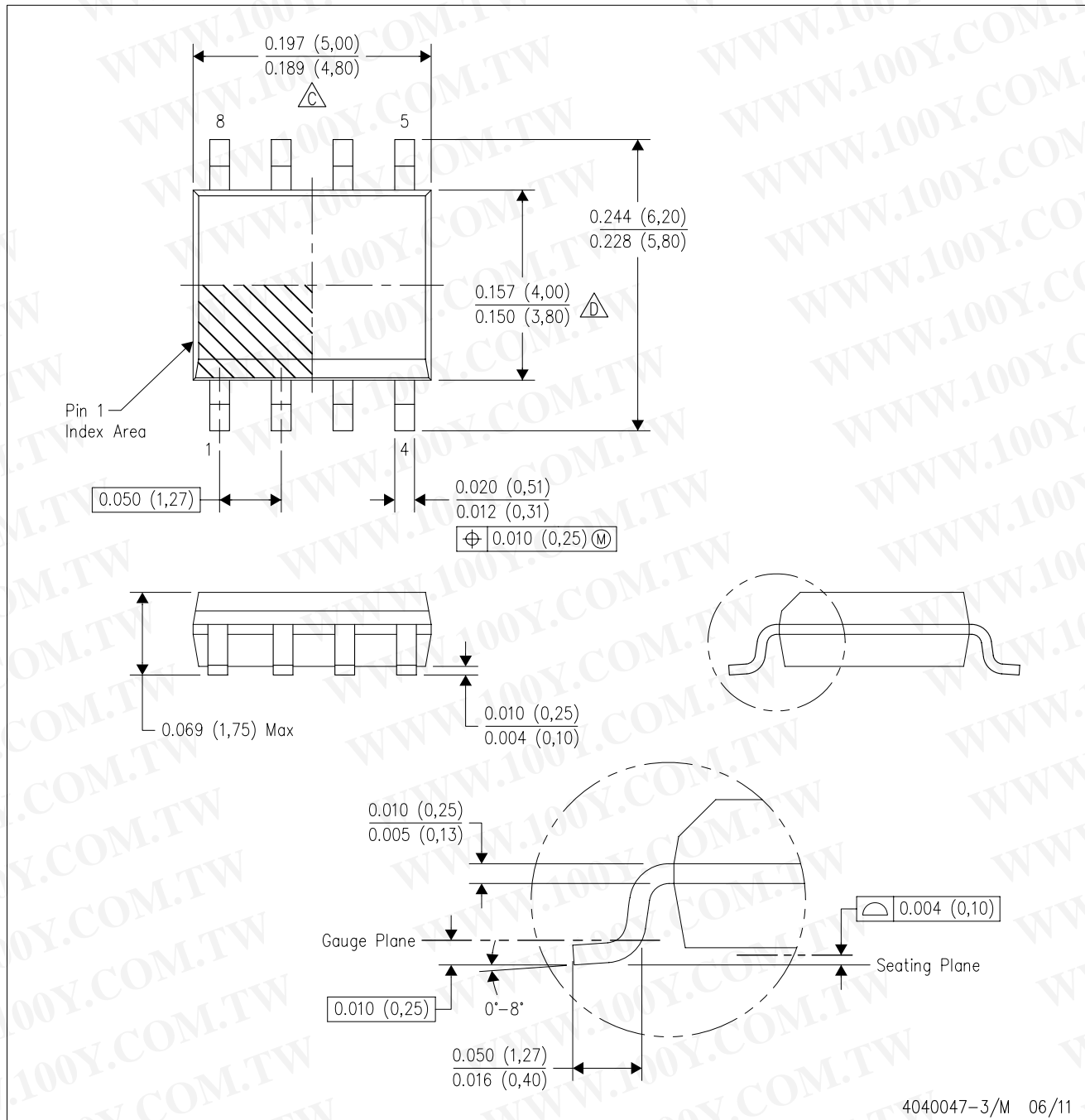

4040047-3/M 06/11

- NOTES:
- A. All linear dimensions are in inches (millimeters).
 - B. This drawing is subject to change without notice.
 - △ Body length does not include mold flash, protrusions, or gate burrs. Mold flash, protrusions, or gate burrs shall not exceed 0.006 (0,15) each side.
 - △ Body width does not include interlead flash. Interlead flash shall not exceed 0.017 (0,43) each side.
 - E. Reference JEDEC MS-012 variation AA.

D (R-PDSO-G8)

PLASTIC SMALL OUTLINE

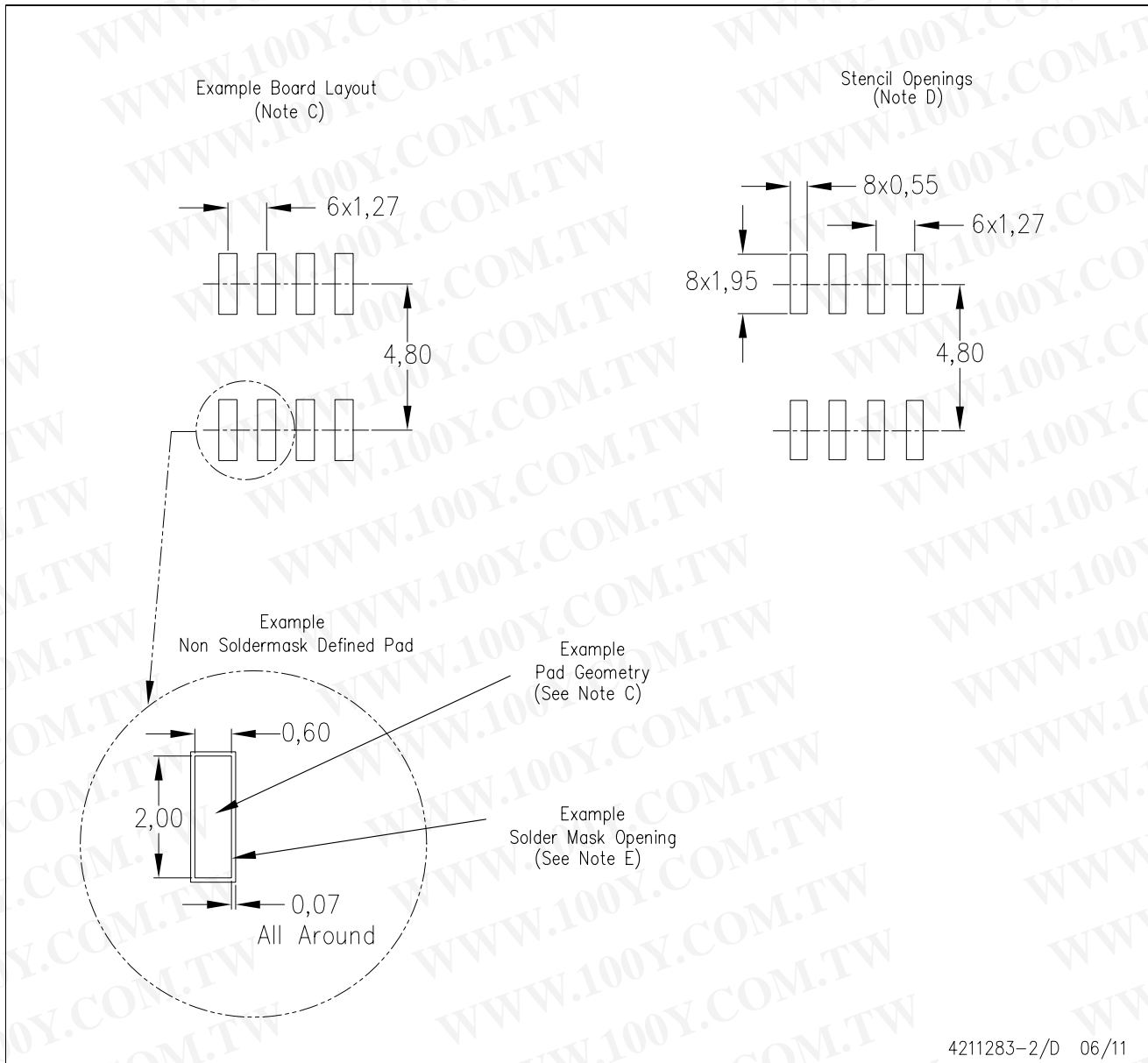

4211283-2/D 06/11

- NOTES:
- All linear dimensions are in millimeters.
 - This drawing is subject to change without notice.
 - Publication IPC-7351 is recommended for alternate designs.
 - Laser cutting apertures with trapezoidal walls and also rounding corners will offer better paste release. Customers should contact their board assembly site for stencil design recommendations. Refer to IPC-7525 for other stencil recommendations.
 - Customers should contact their board fabrication site for solder mask tolerances between and around signal pads.

勝特力材料 886-3-5753170
勝特力电子(上海) 86-21-34970699
勝特力电子(深圳) 86-755-83298787
[Http://www.100y.com.tw](http://www.100y.com.tw)

IMPORTANT NOTICE

Texas Instruments Incorporated and its subsidiaries (TI) reserve the right to make corrections, modifications, enhancements, improvements, and other changes to its products and services at any time and to discontinue any product or service without notice. Customers should obtain the latest relevant information before placing orders and should verify that such information is current and complete. All products are sold subject to TI's terms and conditions of sale supplied at the time of order acknowledgment.

TI warrants performance of its hardware products to the specifications applicable at the time of sale in accordance with TI's standard warranty. Testing and other quality control techniques are used to the extent TI deems necessary to support this warranty. Except where mandated by government requirements, testing of all parameters of each product is not necessarily performed.

TI assumes no liability for applications assistance or customer product design. Customers are responsible for their products and applications using TI components. To minimize the risks associated with customer products and applications, customers should provide adequate design and operating safeguards.

TI does not warrant or represent that any license, either express or implied, is granted under any TI patent right, copyright, mask work right, or other TI intellectual property right relating to any combination, machine, or process in which TI products or services are used. Information published by TI regarding third-party products or services does not constitute a license from TI to use such products or services or a warranty or endorsement thereof. Use of such information may require a license from a third party under the patents or other intellectual property of the third party, or a license from TI under the patents or other intellectual property of TI.

Reproduction of TI information in TI data books or data sheets is permissible only if reproduction is without alteration and is accompanied by all associated warranties, conditions, limitations, and notices. Reproduction of this information with alteration is an unfair and deceptive business practice. TI is not responsible or liable for such altered documentation. Information of third parties may be subject to additional restrictions.

Resale of TI products or services with statements different from or beyond the parameters stated by TI for that product or service voids all express and any implied warranties for the associated TI product or service and is an unfair and deceptive business practice. TI is not responsible or liable for any such statements.

TI products are not authorized for use in safety-critical applications (such as life support) where a failure of the TI product would reasonably be expected to cause severe personal injury or death, unless officers of the parties have executed an agreement specifically governing such use. Buyers represent that they have all necessary expertise in the safety and regulatory ramifications of their applications, and acknowledge and agree that they are solely responsible for all legal, regulatory and safety-related requirements concerning their products and any use of TI products in such safety-critical applications, notwithstanding any applications-related information or support that may be provided by TI. Further, Buyers must fully indemnify TI and its representatives against any damages arising out of the use of TI products in such safety-critical applications.

TI products are neither designed nor intended for use in military/aerospace applications or environments unless the TI products are specifically designated by TI as military-grade or "enhanced plastic." Only products designated by TI as military-grade meet military specifications. Buyers acknowledge and agree that any such use of TI products which TI has not designated as military-grade is solely at the Buyer's risk, and that they are solely responsible for compliance with all legal and regulatory requirements in connection with such use.

TI products are neither designed nor intended for use in automotive applications or environments unless the specific TI products are designated by TI as compliant with ISO/TS 16949 requirements. Buyers acknowledge and agree that, if they use any non-designated products in automotive applications, TI will not be responsible for any failure to meet such requirements.

Following are URLs where you can obtain information on other Texas Instruments products and application solutions:

Products

Audio www.ti.com/audio
Amplifiers amplifier.ti.com
Data Converters dataconverter.ti.com
DLP® Products www.dlp.com
DSP dsp.ti.com
Clocks and Timers www.ti.com/clocks
Interface interface.ti.com
Logic logic.ti.com
Power Mgmt power.ti.com
Microcontrollers microcontroller.ti.com
RFID www.ti-rfid.com
OMAP Mobile Processors www.ti.com/omap
Wireless Connectivity www.ti.com/wirelessconnectivity

Applications

Communications and Telecom www.ti.com/communications
Computers and Peripherals www.ti.com/computers
Consumer Electronics www.ti.com/consumer-apps
Energy and Lighting www.ti.com/energy
Industrial www.ti.com/industrial
Medical www.ti.com/medical
Security www.ti.com/security
Space, Avionics and Defense www.ti.com/space-avionics-defense
Transportation and Automotive www.ti.com/automotive
Video and Imaging www.ti.com/video

TI E2E Community Home Page

e2e.ti.com

Mailing Address: Texas Instruments, Post Office Box 655303, Dallas, Texas 75265
Copyright © 2011, Texas Instruments Incorporated