



**MC68160
MC68160B
MC68160C**

Enhanced Ethernet Transceiver

The MC68160, B and C Enhanced Ethernet Interface Circuit is a BiCMOS device which supports both IEEE 802.3* Access Unit Interface (AUI) and 10BASE-T Twisted Pair (TP) Interface media connections through external isolation transformers. It encodes NRZ data to Manchester data and supplies the signals which are required for data communication via 10BASE-T or AUI interfaces. The MC68160, B and C gluelessly interface to the Ethernet controller contained in the MC68360 Quad Integrated Communications Controller (QUICC) device. The MC68160 also interfaces easily to most other industry-standard IEEE 802.3 LAN controllers.** Prior to twisted pair data reception, Smart Squelch circuitry qualifies input signals for correct amplitude, pulse width, and sequence requirements.

- Automatic Twisted Pair Wiring Polarity Fault Detection and Correction Option
- Automatic Port Selection Option with Status Output
- Driver Pre-emphasis for Twisted Pair Output Data
- Crystal Controlled Clock Oscillator or External Clock Generator Option
- Digital Phase-Locked-Loop (DPLL) Timing Recovery and Data Decoding
- Standby Mode with Reduced Power Consumption
- Twisted Pair Signal Quality Error (Heartbeat) Test Option
- Diagnostic Local Loop Back Option
- Transmit, Receive and Collision Detection Status Output
- Full-Duplex Operation Option on Twisted Pair Port
- Twisted Pair Jabber Detection and Status Output
- Link Integrity Testing and Status Output

* MC68160B does not support all IEEE 802.3 specifications over extended temperature range. Exceptions noted in specifications.

** MC68160B, C only support Motorola controllers

The sale and use of this product is licensed under technology covered by one or more Digital Equipment Corporation patents.

**ENHANCED ETHERNET
INTERFACE TRANSCEIVER**

**SEMICONDUCTOR
TECHNICAL DATA**

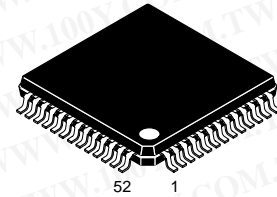

FB SUFFIX
PLASTIC PACKAGE
CASE 848D
(TQFP-52)

ORDERING INFORMATION

Device	Operating Temperature Range	Package
MC68160FB	T _A = 0° to + 70°C	TQFP-52
MC68160CFB		TQFP-52
MC68160BFB	T _A = -40° to + 85°C	TQFP-52

勝特力材料 886-3-5753170
 勝特力电子(上海) 86-21-34970699
 勝特力电子(深圳) 86-755-83298787
[Http://www.100y.com.tw](http://www.100y.com.tw)

MC68160 MC68160B MC68160C

Figure 1. 10Base-T Interface Block Diagram

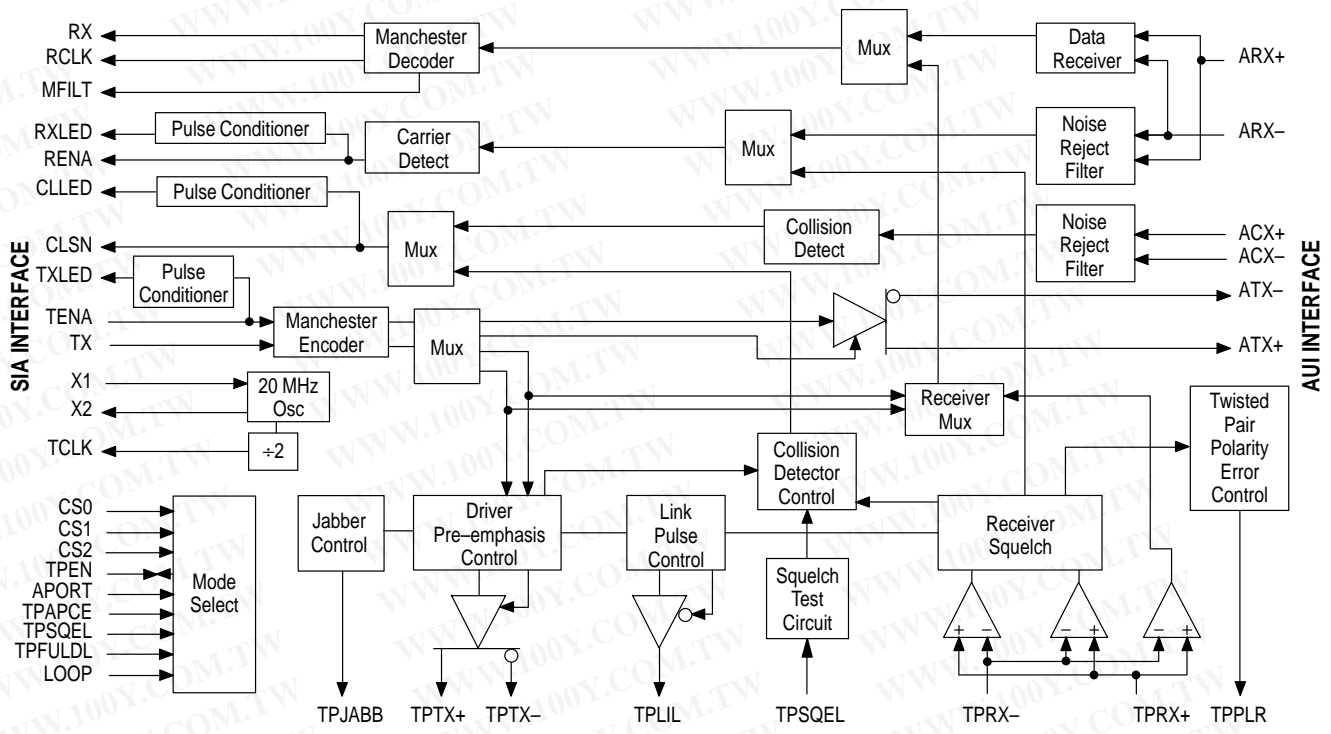

This device contains 20,000 active transistors.

勝特力材料 886-3-5753170
 勝特力电子(上海) 86-21-34970699
 勝特力电子(深圳) 86-755-83298787
[Http://www.100y.com.tw](http://www.100y.com.tw)

MC68160 MC68160B MC68160C

Enhanced Ethernet Serial Transceiver

Table 1. Pin Descriptions	4
Controller Interface Pins	4
AUI Interface Pins	4
Twisted Pair Interface Pins	4
Oscillator and Frequency Multiplier Pins	5
Mode Select Pins	5
Status Indicator Pins	6
Power Supply and Ground Pins	6
Table 2. Controller Interface Selection	7
Table 3. Controller Independent Mode Selection	7
Electrical Characteristics	8
Maximum Ratings	8
Recommended Operating Conditions	8
ESD	8
DC Characteristics	8
Power Supply DC Characteristics	8
TTL/CMOS Input and Output DC Characteristics	9
Twisted Pair Input and Output DC Characteristics	9
AUI Input and Output DC Characteristics	10
AC Characteristics	12
External Clock Input (X1) Switching Characteristics	12
Receive Phase Locked Loop Switching Characteristics	12
Controller Transmit Switching Characteristics (Motorola Mode)	12
Controller Receive Switching Characteristics (Motorola Mode)	12
Controller Transmit Switching Characteristics (Intel Mode)	14
Controller Receive Switching Characteristics (Intel Mode)	14
Controller Transmit Switching Characteristics (Fujitsu Mode)	15
Controller Receive Switching Characteristics (Fujitsu Mode)	15
Controller Transmit Switching Characteristics (National Mode)	16
Controller Receive Switching Characteristics (National Mode)	16
TP Transmit Switching Characteristics	18
TP Transmit Jabber Switching Characteristics	20
TP Transmit Signal Quality Error Test Switching Characteristics	20
TP Receive Switching Characteristics	21
TP Receive Link Integrity Switching Characteristics	21
TP Collision Switching Characteristics	23
TP Full Duplex Switching Characteristics	23
AUI Transmit Switching Characteristics	24
AUI Receive Switching Characteristics	24
Functional Description	25
Data Transmission	25
Data Reception	26
Collision	26
Jabber	26
Full Duplex	26
Auto Port Selection	26
Auto Polarity Selection	26
Loop Back Mode	26
Applications	27
Selection of Crystal and External Components	27
PLL Filter Components	27
10BASE-T Filter and Transformer Choice	27
AUI Transformer Choice	27

勝特力材料 886-3-5753170
 勝特力电子(上海) 86-21-34970699
 勝特力电子(深圳) 86-755-83298787
[Http://www.100y.com.tw](http://www.100y.com.tw)

MC68160 MC68160B MC68160C

Table 1. Pin Function Description

Pin(s)	Symbol	Type	Name/Function
CONTROLLER INTERFACE			
1	RENA	O TTL/CMO	Receive Enable Output: Indication of the presence of network activity, synchronous to RCLK. In the standby mode, RENA is driven to the high impedance state.
2	RX	O TTL/CMOS	Receive Data Output: Recovered data, synchronous to RCLK. Following a reset operation, 100 ms should be allowed before attempting to read data processed by the MC68160, B and C. This delay is needed to insure that the receive phase locked loop is properly synchronized with incoming data. In the standby mode, RX is driven to the high impedance state.
48	TCLK	O TTL/CMOS	Transmit Clock Output CMOS/TTL Output: TCLK provides a symmetrical clock signal at 10 MHz for reference timing of data to be encoded. In the standby mode, TCLK is driven to the high impedance state.
49	TENA	I TTL	Transmit Enable Input: Input signal synchronous to TCLK which enables data transmission on the active port. An internal pull-down resistor is provided so that the input is low under no connect conditions. (This resistor is removed in the standby mode). If TENA is asserted at the conclusion of a reset operation, it must first be deasserted and then reasserted before data transmission can occur. In the standby mode, TENA is driven to the high impedance state.
50	RCLK	O TTL/CMOS	Receive Clock Output: Recovered clock. In the standby mode, RCLK is driven to the high impedance state.
51	CLSN	O TTL/CMOS	Collision Output: In the AUI mode, indicates the presence of signals at the ACX+ and ACX- terminals which meet threshold and pulse width requirements. In the TP mode, indicates simultaneous transmit and receive activity, a heartbeat (SQE Test) signal was generated, or the jabber timer has expired. In the standby mode, CLSN is driven to the high impedance state.
52	TX	I TTL	Transmit Data Input: Input signal synchronous to TCLK which provides NRZ serial data to be Manchester encoded. In the standby mode, TX is driven to the high impedance state.
AUI INTERFACE			
21 22	ACX- ACX+	I	AUI Differential Collision Inputs: These inputs are connected to a pair of internally biased line receivers consisting of a carrier detect receiver with offset threshold and noise filtering to detect the line activity. Signals at ACX+/- have no effect on data path functions.
23 24	ARX- ARX+	I	AUI Differential Receiver Inputs: These inputs are connected to a pair of internally biased line receivers consisting of a carrier detect receiver with offset threshold and noise filtering to detect the line activity, and a data receiver with no offset for Manchester Data reception.
25 26	ATX- ATX+	O	AUI Differential Transmit Outputs : This line pair is intended to operate into terminated transmission lines. For TX signals meeting setup and hold time to TCLK when TENA is previously asserted, Manchester encoded data is outputted at ATX+/- . When operating into a 78 Ω terminated transmission line, signaling meets the required output levels and skew for IEEE-802.3 drop cables. When the 10BASE-T port is automatically or manually selected, the AUI outputs are driven to a low power standby state in which the outputs deliver a balanced high state voltage.
TWISTED PAIR INTERFACE			
31 32	TPRX- TPRX+	I	Twisted Pair Differential Receiver Inputs: These inputs are connected to a receiver with Smart Squelch capability which only allows differential receive data to pass as long as the input amplitude is greater than a minimum signal threshold level and a specific pulse sequence is received. This assures a good signal to noise ratio while the signal pair is active by preventing crosstalk and impulse noise conditions from activating the receive function.
36 37	TPTX- TPTX+	O	Twisted Pair Differential Transmitter Outputs: These lines have pre-distortion drive capability and are intended to drive terminated twisted pair transmission lines. When the AUI port is manually selected, the 10BASE-T outputs are driven to a low power standby state in which the outputs deliver a balanced high state voltage. However, when the AUI port is automatically selected, the 10BASE-T outputs remain active.

NOTE: The sense of the controller interface pins will change, depending on the controller selected.

勝特力材料 886-3-5753170
 勝特力电子(上海) 86-21-34970699
 勝特力电子(深圳) 86-755-83298787
[Http://www.100y.com.tw](http://www.100y.com.tw)

MC68160 MC68160B MC68160C

Table 1. Pin Function Description (continued)

Pin(s)	Symbol	Type	Name/Function
OSCILLATOR AND FREQUENCY MULTIPLIER			
12	MFILT	C	Frequency Multiplier Filter Connection Point: An external resistor capacitor filter must be attached to this pin.
16	X1	I/C CMOS	Oscillator Inverter Input and Crystal Connection Point: When connected for crystal oscillator operation, the frequency of the clock which appears at TCLK is half that of the crystal oscillator. As an option, instead of connecting to a crystal, X1 may be driven from an external 20 MHz CMOS compatible clock generator.
17	X2	O/C CMOS	Oscillator Inverter Output and Crystal Connection Point: This pin is used only for the connection of an external crystal and capacitor. It must be left unconnected if X1 is driven by an external CMOS Clock generator.

MODE SELECT

3 4 5	CS0 CS1 CS2	I TTL	Mode Select: The logic states applied to these pins select the appropriate interface for the desired IEEE-802.3 controller or enable the standby mode. When the standby mode is selected, the MC68160, B and C power supply current is greatly reduced. Additionally, in the standby mode, all of the controller inputs and outputs are driven to the high impedance state.
6	LOOP	I TTL	Diagnostic Loopback: Asserting this function causes serial NRZ data at the TX input to be Manchester encoded and then looped back through the Manchester decoder, appearing at the RX output. This diagnostic loopback function operates independent of Twisted Pair (TP) or Access Unit Interface (AUI) port connectivity or activity. Neither the TP port nor the AUI port transmits data from the controller while diagnostic loopback is selected. Likewise, the controller interface receives data neither from the TP nor the AUI receivers while in this mode. The polarity fault detection and link integrity functions are not inhibited by the diagnostic loopback mode. If otherwise enabled, they continue to function. If the twisted pair port is selected, and TPSQEL is driven to the low logic state, a collision detect pulse is delivered following each transmission to simulate the twisted pair SQE test.
9	APORT	I TTL	Automatic Port Selection Enable: When high, MC68160, B and C will automatically select the TP or AUI port based on the presence or absence of valid link beats or frames at the TP receive input. If the AUI port is automatically selected, the MC68160, B and C will continue to produce link pulses for the TP port. Changing ports requires approximately 1.0 ms to allow the circuitry for the new port to resume normal operation. The power consumption is minimized in the circuitry associated with the unselected port.
27	TPSQEL	I TTL	Twisted Pair Signal Quality Error Test Enable: Forcing this pin low enables testing of the internal TP collision detect circuitry after each transmit operation to the TP media. This function provides a simulated collision to as much of the MC68160, B and C collision detect circuitry as possible without affecting the attached twisted pair channel. A normal SQE test results in a high logic state at the CLSN controller interface pin which begins 6 to 16-bit times after the last transition of a transmitted signal and continues for 5 to 15-bit times. (When the AUI port is selected, SQE test signals are generated by the coaxial cable transceiver and delivered to the controller via the MC68160, B and C ACX+/- receive inputs)
28	TPFULDL	I TTL	Twisted Pair Full Duplex Mode Select: Forcing this pin low allows simultaneous transmit and receive operation on the twisted pair port without an indicated collision. This pin is not to be asserted with LOOP as a test mode is enabled that disrupts normal operation.
29	TPAPCE	I TTL	Twisted Pair Automatic Polarity Correction Enable: When TPAPCE is high, automatic polarity correction is enabled, and MC68160, B and C will internally correct for a polarity fault on the receive circuit. Additionally, when TPAPCE is high, the presence of a polarity fault is indicated on TPPLR.
46	TPEN	I/O TTL (TTL/CMOS)	Twisted Pair Port Enable: If APORT is low, TPEN is an input which determines whether the AUI port (TPEN low) or TP port (TPEN high) will be manually selected. If the AUI port is manually selected, the MC68160, B and C will not produce link pulses for the TP port. If APORT is high, TPEN is an output which will indicate which port has been automatically selected by driving TPEN low (for AUI) or high (for TP). In its output mode TPEN can sink 10 mA in the low output state and source 10 mA in the high output state. (See Pin 9 Description.) Changing ports requires approximately 1.0 ms to allow the circuitry for the new port to resume normal operation. The power consumption is minimized in the circuitry associated with the unselected port. In the standby mode, this pin is driven to the high impedance state.

勝特力材料 886-3-5753170
 勝特力电子(上海) 86-21-34970699
 勝特力电子(深圳) 86-755-83298787
[Http://www.100y.com.tw](http://www.100y.com.tw)

MC68160 MC68160B MC68160C

Table 1. Pin Function Description (continued)

Pin(s)	Symbol	Type	Name/Function
STATUS INDICATOR			
40	TXLED	O TTL/CMOS	Transmit Status LED Driver Output: This pin indicates the transmit status of the currently selected TP or AUI port. When there is no transmit activity detected, an internal pull-up takes this pin to its normal off (high) state. When transmit activity is detected, the LED driver turns on. In its on state, TXLED flashes the LED by driving low at approximately 10 Hz at a 50% duty cycle. In the standby mode, this output is driven to the high impedance state.
41	RXLED	O TTL/CMOS	Receive Status LED Driver Output: This pin indicates the receive status of the currently selected TP or AUI port. When there is no receive activity detected, an internal pull-up takes this pin to its normal off (high) state. When receive activity is detected, the LED driver turns on. In its on state, RXLED flashes the LED by driving low at approximately 10 Hz at a 50% duty cycle. In the standby mode, this output is driven to the high impedance state.
42	CLLED	O TTL/CMOS	Collision Status LED Driver Output: This pin indicates the collision status of the currently selected TP or AUI port. When there is no collision activity detected, an internal pull-up takes this pin to its normal off (high) state. When collision activity is detected, the LED driver turns on. In its on state, CLLED flashes the LED by driving low at approximately 10 Hz at a 50% duty cycle. In the standby mode, this output is driven to the high impedance state.
43	TPLIL	O TTL/CMOS	Twisted Pair Link Integrity Output: This output is driven to the low output state to indicate good link integrity on the TP port during TP mode. It is deasserted (high) when link integrity fails in TP mode. The TPLIL output is driven to the high impedance state when the AUI port is selected. In the standby mode, this output is also driven to the high impedance state.
44	TPPLR	O TTL/CMOS	Twisted Pair Polarity Error Output: If TPAPCE is high and the wires connected to the Twisted Pair Receiver Inputs (TPRX+, TPRX-) are reversed, TPPLR will be driven to the low logic state to indicate the fault. TPPLR remains low when the MC68160, B and C has automatically corrected for the reversed wires. If the twisted pair link integrity tests fail, this output will be driven to the high logic state. When the AUI mode is selected this output is driven to the high impedance state. In the standby mode, this output is also driven to the high impedance state.
45	TPJABB	O TTL/CMOS	Twisted Pair Jabber Output: This pin is driven high to indicate a jabber condition at the TPTX+/- outputs. (Jabber condition also causes CLLED to be driven alternately to the high and low output levels). TPJABB is driven to the low output state when no jabber condition is present. When the AUI mode is selected this output is driven to the high impedance state. In the standby mode, this output is also driven to the high impedance state.

POWER SUPPLY AND GROUND

10	VDDDIV		Frequency Divider Supply Pin
11 13	VDDFM GNDFM		Frequency Multiplier Supply and Ground Pins
14 15	GNDVCO VDDVCO		Voltage Controlled Oscillator Ground and Supply Pins
20	GNDSUB		Substrate Ground Pin
7 8 18 19	VDDDIG GNDDIG VDDDIG GNDDIG		Digital Supply and Ground Pins
30 33	VDDANA GNDANA		Analog Supply and Ground Pins
34 35 38 39	GNDPWR VDDPWR VDDPWR GNDPWR		Power Supply and Ground Pins
47	GNDCTL		Controller Interface Ground Pin

NOTE: Power and ground pins are not connected internally. Failure to connect externally may cause malfunction or damage to the IC.

勝特力材料 886-3-5753170
 勝特力电子(上海) 86-21-34970699
 勝特力电子(深圳) 86-755-83298787
[Http://www.100y.com.tw](http://www.100y.com.tw)

MC68160 MC68160B MC68160C

Table 2. Controller Interface Selection

Motorola Transceiver MC68160, B and C (EEST™)	Motorola Controller ² MC68360 (QUICC™)	Intel ⁴ Controllers 82586, 82590, 82593, 82596	Fujitsu ⁴ Controllers 86950 (Etherstar™) 86960 (NICE™)	National ⁴ Controllers 8390, 83C690, 83932B (SONIC™)				
CS0	1	0	1	0				
CS1	1	1	0	0				
CS2	0	0	0	0				
Pin	Pin	Sense	Pin	Sense	Pin	Sense	Pin	Sense
TCLK	TCLK	High	TXC	Low	TCKN	Low	TXC	High
TX	TX	High	TXD	High	TXD	High	TXD	High
TENA	TENA	High	RTS	Low	TEN	High	TXE	High
RCLK	RCLK	High	RXC	Low	RCN	Low	RXC	High
RX	RX	High	RXD	High	RXD	High	RXD	High
RENA	RENA	High	CRS	Low	XCD	High	CRS	High
CLSN	CLSN	High	CDT	Low	XCOL	Low	COL	High
LOOP ¹	N.A.	High	LPBK	Low	LBC	High	LPBK	High

- NOTES:** 1. Although LOOP input is not ordinarily classified as a controller pin, it is included in this table because its sense varies according to the controller used.
 2. The Motorola controller interface contained in the MC68360 (QUICC™) is compatible with the AMD 7990 (LANCET™) and 79C900 (ILACC™) controllers.
 3. The pin sense is shown from the perspective of the identified controller pin.
 4. Supported only by MC68160.

Table 3. Controller Independent Mode Selection

Pin	Standby Mode	Reserved	Reserved	Reserved
CS0	1	0	1	0
CS1	1	1	0	0
CS2	1	1	1	1

NOTE: In standby mode, the MC68160, B, C consumes less power supply current than in any other mode. Additionally, in the standby mode, all of the controller inputs and outputs are driven to the high impedance state. When the standby mode is deasserted, an internal reset pulse of approximately 6.0 μs duration is generated.

Following a period of operation in the standby mode, the time required to insure stable data reception is approximately 100 ms.

勝特力材料 886-3-5753170
 勝特力电子(上海) 86-21-34970699
 勝特力电子(深圳) 86-755-83298787
[Http://www.100y.com.tw](http://www.100y.com.tw)

Figure 2. Applications Block Diagram

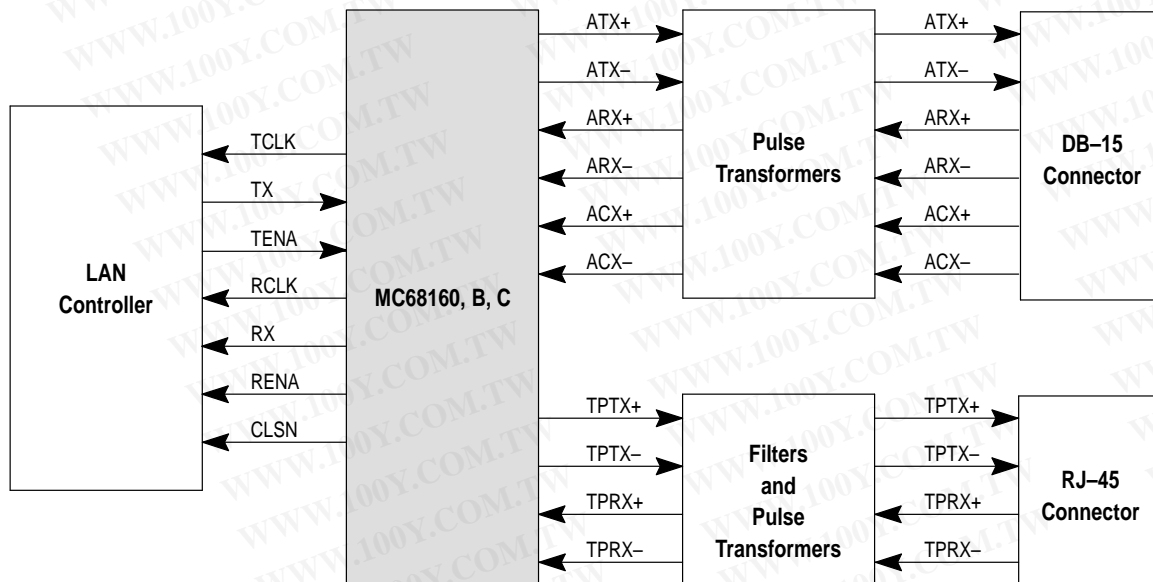

MC68160 MC68160B MC68160C

ELECTRICAL CHARACTERISTICS

MAXIMUM RATINGS

Characteristic	Symbol	Min	Max	Unit
Storage Temperature Range	T_{stg}	-65	150	°C
Power Supply Voltage Range				
Analog	V_{DDA}	-	7.0	V
Digital	V_{DDD}	-	7.0	V
Voltage on any TTL compatible input pin with respect to Ground	V	-0.5	$V_{DD} + 0.5$	V
Voltage on TPRX, ARX, or ACX input pins with respect to Ground		-0.5	6.0	V
Differential Voltage on TPRX, ARX, or ACX Input Pins	V_{DIFF}	-6.0	6.0	V

NOTE: Stresses in excess of the Absolute Maximum Ratings can cause permanent damage to the device. Functional operation of the device is not implied at these or any other conditions in excess of those indicated in the operation sections of this data sheet. Exposure to Absolute Maximum Ratings conditions for extended periods can adversely affect device reliability.

RECOMMENDED OPERATING CONDITIONS

Characteristic	Symbol	Min	Max	Unit
Power Supply Voltage Range	V_{DD}	4.75	5.25	V
Power Supply Ripple (20 kHz to 100 kHz)	-	-	50	mV
Power Supply Impulse Noise (Either Polarity)	-	-	100	mV
Ambient Operating Temperature Range (MC68160, MC68160C)	T_A	0	70	°C
Ambient Operating Temperature Range (MC68160B)	T_A	-40	85	°C
ARX/ACX Input Differential Rise and Fall Time (see Figure 39)	t_{260}	2.0	10	ns
ARX Pair Idle Time after Transmission (see Figure 39)	t_{265}	8.0	-	μs

ESD

Although protection circuitry has been designed into this device, proper precautions should be taken to avoid exposure to electrostatic discharge (ESD) during handling and mounting. Motorola employs a Human Body Model (HBM) and a Charged Device Model (CDM) for ESD-susceptibility testing and protection design evaluation. ESD has been adopted for the CDM, however, a standard HBM (resistance = 1500 Ω capacitance = 100 pF) is widely used and, therefore, can be used for comparison purposes. The HBM ESD threshold presented here was obtained by using the circuit parameters contained in this specification. ESD threshold voltage is designed to 700 kV Human Body Model.

DC ELECTRICAL CHARACTERISTICS (Unless otherwise noted, minimum and maximum limits apply over the recommended ambient operating temperature and power supply voltage ranges.)

Characteristic	Symbol	Test Conditions	Min	Typ	Max	Unit
POWER SUPPLY						
Undervoltage Shutdown Threshold	-	-	-	-	4.4	V
Power Supply Current	I_{DD}	- Standby Mode	- -	145 -	200 5.0	mA

勝特力材料 886-3-5753170
 勝特力电子(上海) 86-21-34970699
 勝特力电子(深圳) 86-755-83298787
[Http://www.100y.com.tw](http://www.100y.com.tw)

MC68160 MC68160B MC68160C

DC ELECTRICAL CHARACTERISTICS ($T_A = 25^\circ\text{C}$, $V_{CC} = 5.0\text{ V} \pm 5\%$. Unless otherwise noted, minimum and maximum limits apply over the recommended ambient operating temperature and power supply voltage ranges for each MC68160, B, C except where noted.)

Characteristic	Symbol	Test Conditions	Min	Max	Unit
----------------	--------	-----------------	-----	-----	------

TTL COMPATIBLE INPUTS

TTL Compatible Input Voltage Low State High State	$V_{IL}(\text{TTL})$ $V_{IH}(\text{TTL})$	–	– 2.0	0.8 –	V
Input Current TTL Compatible Input Pins (Note 1) Input Current TENA TTL Compatible Input Pin: with Pull-Down Resistor		$0\text{ V} < V_I < V_{DD}$	–	± 10	μA
I_{IH} I_{IL} with Pull-Down Resistor removed in Standby Mode	I_{IH} I_{IL} $I_{IH} \& I_{IL}$		– – –	+200 –20 ± 10	

CMOS COMPATIBLE INPUTS

CMOS Compatible Input Voltage Low State High State	$V_{IL}(\text{CMOS})$ $V_{IH}(\text{CMOS})$	–	– 3.0	1.0 –	V
Input Current (Pin X1)	$I_{IH} \& I_{IL}$	$0\text{ V} < V_I < V_{DD}$	–	± 100	μA

TTL/CMOS COMPATIBLE OUTPUTS

TTL/CMOS Compatible Output Voltage Low State (Note 2) Low State (Note 3)	V_{OL}	$I_{OL} = 4.0\text{ mA}$ $I_{OL} = 10\text{ mA}$	– –	0.45 0.45	V
TTL/CMOS Compatible Output Voltage High State (Note 4) High State (Note 5) High State (Note 2)	V_{OH}	$I_{OH} = -500\text{ }\mu\text{A}$ $I_{OH} = -10\text{ mA}$ $I_{OH} = -4.0\text{ mA}$	3.9 3.9 2.4	– – –	V
Three State Output Leakage Current	I_{OZ}	$0\text{ V} \leq V_{OZ} \leq V_{DD}$	–	± 10	μA

Characteristic	Symbol	Test Conditions	Min	Max	Unit
----------------	--------	-----------------	-----	-----	------

TWISTED PAIR RECEIVER INPUTS

Input Voltage Range (DC + AC)	V_{ITP}	–	1.5	4.3	V
Differential Input Squelch Threshold Voltage (MC68160, MC68160C)	V_{ITPSQ}	Note 10	270	390	mV
Differential Input Squelch Threshold Voltage (MC68160B)	V_{ITPSQ}	Note 10	260	400	mV
Common Mode Bias Generator Voltage	V_{BCMTP}	Note 9	1.8	3.2	V
Common Mode Input Resistance	R_{CMTP}	–	1000	–	Ω
Differential Input Resistance	R_{DIFFTP}	–	2.5	–	k Ω

TWISTED PAIR TRANSMITTER OUTPUTS

Differential Output Voltage Pre-Emphasis Level Signal Level (MC68160, MC68160C) Signal Level (MC68160B)	V_{ODFTPP} V_{ODFTPS} V_{ODFTPS}	Note 7	± 2.2 ± 1.56 ± 1.38	± 2.8 ± 1.98 ± 1.98	V
Common Mode Output Voltage Range	V_{OCMTP}	Note 6	0	4.0	V
Common Mode Output Voltage in Standby Mode	$V_{OCMTPSB}$	$I_{OH} = -100\text{ }\mu\text{A}$	$V_{DD} - 1.0$	V_{DD}	V

- NOTES:**
1. APORT, TPAPCE, CS0, CS1, CS2, TX, LOOP, TPFULDL, TPSQEL and TPEN (In Input Mode).
 2. TCLK, RX, RCLK, RENA and CLSN.
 3. TPPLR, TPLIL, TPJABB, TXLED, RXLED, CLLED and TPEN (In Output Mode).
 4. TPPLR, TPLIL, CLLED, TXLED and RXLED.
 5. TPJABB and TPEN (In Output Mode).
 6. Measured with Test Load B1 (shown in Figure 3), applied directly to the TPTX+/- pins of the device.
 7. Measured differentially with Test Load B2 (shown in Figure 4), applied directly to the TPTX+/- pins of the device.
 8. Measured directly on the TPTX+/- pins of the device.
 9. Measured with Test Load B3 (shown in Figure 5), applied directly to the TPRX+/- pins of the device.
 10. The Common Mode Input Voltage is between 1.8 V and 3.2 V.

勝特力材料 886-3-5753170
 勝特力电子(上海) 86-21-34970699
 勝特力电子(深圳) 86-755-83298787
[Http://www.100y.com.tw](http://www.100y.com.tw)

MC68160 MC68160B MC68160C

DC ELECTRICAL CHARACTERISTICS (continued) ($T_A = 25^\circ\text{C}$, $V_{CC} = 5.0\text{ V} \pm 5\%$. Unless otherwise noted, minimum and maximum limits apply over the recommended ambient operating temperature and power supply voltage ranges for each MC68160, B, C except where noted.)

Characteristic	Symbol	Test Conditions	Min	Max	Unit
TWISTED PAIR TRANSMITTER OUTPUTS					
Differential Output Voltage IDLE Mode Open Circuit	V_{ODFTPI} V_{ODFTPO}	Note 6 Note 8	– –	± 50 5.25	mV V
Differential Output Impedance TRANSMISSION Mode IDLE Mode	R_{ODFTPT} R_{ODFTPI}	Note 8	12 8.0	28 29	Ω
Common Mode Output Impedance TRANSMISSION Mode (MC68160, MC68160C) TRANSMISSION Mode (MC68160B) IDLE Mode	R_{OCMTPT} R_{OCMTPT} R_{OCMTPI}	Note 8	3.0 2.5 1.0	7.0 7.0 10	Ω k Ω

- NOTES:**
1. APORT, TPAPCE, CS0, CS1, CS2, TX, LOOP, TPFULDL, TPSQEL and TPEN (In Input Mode).
 2. TCLK, RX, RCLK, RENA and CLSN.
 3. TPPLR, TPLIL, TPJABB, TXLED, RXLED, CLLED and TPEN (In Output Mode).
 4. TPPLR, TPLIL, CLLED, TXLED and RXLED.
 5. TPJABB and TPEN (In Output Mode).
 6. Measured with Test Load B1 (shown in Figure 3), applied directly to the TPTX+/- pins of the device.
 7. Measured differentially with Test Load B2 (shown in Figure 4), applied directly to the TPTX+/- pins of the device.
 8. Measured directly on the TPTX+/- pins of the device.
 9. Measured with Test Load B3 (shown in Figure 5), applied directly to the TPRX+/- pins of the device.
 10. The Common Mode Input Voltage is between 1.8 V and 3.2 V.

DC ELECTRICAL CHARACTERISTICS (Unless otherwise noted, minimum and maximum limits apply over the recommended ambient operating temperature and power supply voltage ranges for each MC68160, B, C except where noted.)

Characteristic	Symbol	Test Conditions	Min	Max	Unit
AUI RECEIVER INPUTS					
Input Voltage Range (DC + AC)	V_{IA}	–	1.0	4.2	V
Differential Mode Input Voltage Range	V_{IDFA}	–	± 318	± 1315	mV
Differential Input Squelch Threshold Voltage (MC68160, MC68160C)	V_{IASQ}	–	–275	–175	mV
Differential Mode Input Voltage Range (MC68160B)	V_{IASQ}	–	–300	–175	mV
Common Mode Input Resistance	R_{ICMA}	$1.0\text{ V} < V_{ICMA} < 4.2\text{ V}$	1.5	–	k Ω
Differential Input Resistance (ARX, ACX Inputs)	R_{IDFA}	$1.0\text{ V} < V_{ICMA} < 4.2\text{ V}$ $318\text{ mV} < V_{IDMA} < 1315\text{ mV}$	5.0	–	k Ω

AUI TRANSMITTER OUTPUTS

Common Mode Output Voltage IDLE Mode ACTIVE Mode STANDBY Mode	V_{OCMIA} V_{OCMAA} V_{OCMSA}	Figure 6 $I_O = -100\ \mu\text{A}$	1.0 1.0 $V_{DD} - 2.0$	4.2 4.2 $V_{DD} - 1.2$	V
Differential Output Voltage IDLE Mode ACTIVE Mode	V_{ODFIA} V_{ODFAA}	Figure 6	– ± 600	± 40 ± 1315	mV
Differential Output Load Current IDLE Mode	I_{ODFIA}	Figure 7	–	± 4.0	mA
Output Short Circuit Current	I_{ODSA}	Output Short Circuited to V_{DD} or GND	–	± 150	mA

勝特力材料 886-3-5753170
 勝特力电子(上海) 86-21-34970699
 勝特力电子(深圳) 86-755-83298787
[Http://www.100y.com.tw](http://www.100y.com.tw)

MC68160 MC68160B MC68160C

Figure 3. Test Load B1

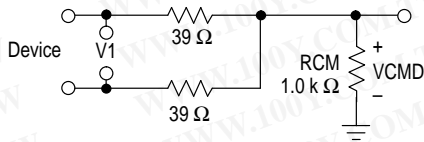

Figure 4. Test Load B2

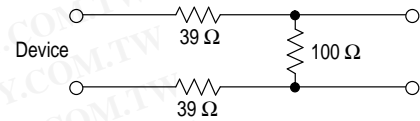
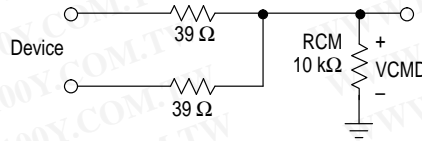

Figure 5. Test Load B3



NOTE: A total of 50 Ω per driver output is required for proper series line termination. This is realized with the 39 Ω external resistors shown in Figures 3, 4 and 5, together with the internal driver output resistance.

Figure 6. AUI Common Mode Termination

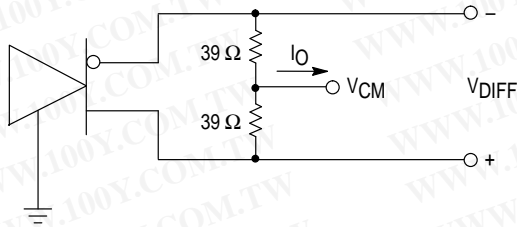
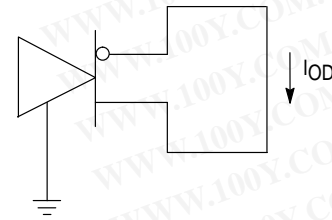

Figure 7. AUI Differential Output Short Circuit Current



勝特力材料 886-3-5753170
 勝特力电子(上海) 86-21-34970699
 勝特力电子(深圳) 86-755-83298787
[Http://www.100y.com.tw](http://www.100y.com.tw)

MC68160 MC68160B MC68160C

AC ELECTRICAL CHARACTERISTICS (Unless otherwise noted, minimum and maximum limits apply over the recommended temperature and power supply voltage ranges for each MC68160, B, C except where noted.)

Characteristic	Symbol	Min	Max	Unit
EXTERNAL CLOCK INPUT (X1)				
Cycle Time (Note 1) (See Figure 8)	t_1	49.995	50.005	ns
Fall Time	t_2	–	5.0	
Rise Time	t_3	–	5.0	
Low Time	t_4	20	30	
High Time	t_5	20	30	
RECEIVE PHASE-LOCKED-LOOP SWITCHING				
Stabilization Time	t_7	–	100	ms
CONTROLLER TRANSMIT SWITCHING (MOTOROLA MODE)				
TCLK Cycle Time	t_{10}	99	101	ns
TCLK High Time	t_{11}	45	55	
TCLK Low Time	t_{12}	45	55	
TCLK Rise and Fall Time	t_{13}	–	8.0	
TX Setup Time to TCLK \uparrow	t_{14}	20	–	ns
TX Hold Time to TCLK \uparrow	t_{15}	0	–	
TENA Setup Time to TCLK \uparrow	t_{16}	20	–	ns
TENA Hold Time to TCLK \uparrow	t_{17}	0	–	
CONTROLLER RECEIVE SWITCHING				
RCLK Cycle Time	t_{20}	90	–	ns
RCLK High Time	t_{21}	42	–	
RCLK Low Time (MC68160, MC68160C)	t_{22}	47	55	
RCLK Low Time (MC68160B)	t_{22}	44	58	
RCLK Rise and Fall Time	t_{23}	–	8.0	
RX Hold Time from RCLK \uparrow	t_{24}	10	–	ns
RX Set-Up Time to RCLK \uparrow	$t_{24.1}$	70	–	
RCLK Delay from RENA \uparrow	t_{25}	–	650	ns
RX Delay from RENA \uparrow	t_{26}	–	600	
RENA Deassertion Delay from RCLK \uparrow (See Figure 12)	t_{27}	10	30	ns

- NOTES:**
- To meet IEEE-802.3 specifications.
 - Load on specified output is 20 pF to ground, unless otherwise noted.
 - \uparrow = Rising Edge

Figure 8. X1 Input Voltage Levels for Timing Measurements

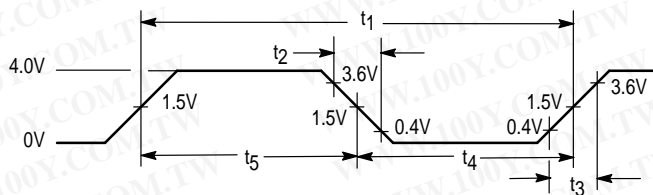

勝特力材料 886-3-5753170
 勝特力电子(上海) 86-21-34970699
 勝特力电子(深圳) 86-755-83298787
[Http://www.100y.com.tw](http://www.100y.com.tw)

MC68160 MC68160B MC68160C

Figure 9. Receive Phase-Locked-Loop Switching

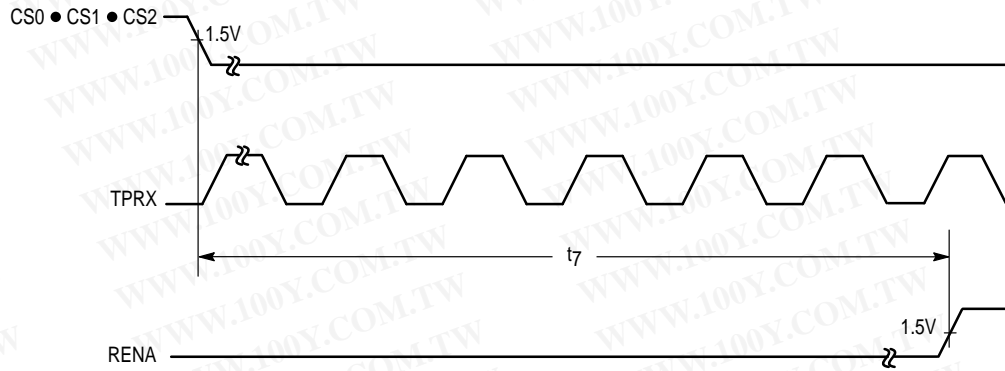

NOTE: CS0 • CS1 • CS2 is the logical AND operation and refers to the pins not at Logic 1.

Figure 10. Transmit Timing (Motorola Mode)

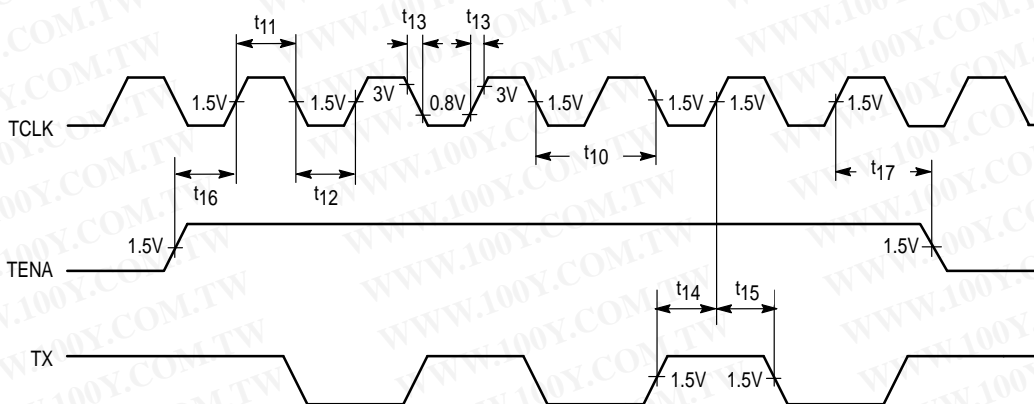
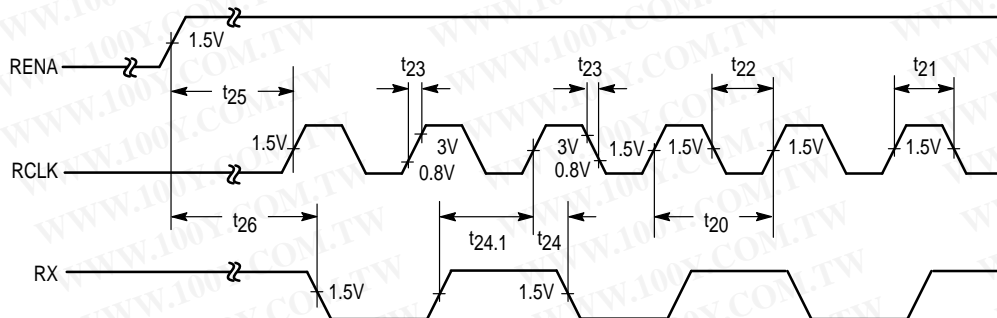

Figure 11. Receive Timing (Motorola Start of Frame)



勝特力材料 886-3-5753170
 勝特力电子(上海) 86-21-34970699
 勝特力电子(深圳) 86-755-83298787
[Http://www.100y.com.tw](http://www.100y.com.tw)

MC68160 MC68160B MC68160C

Figure 12. Receive Timing (Motorola End of Frame)

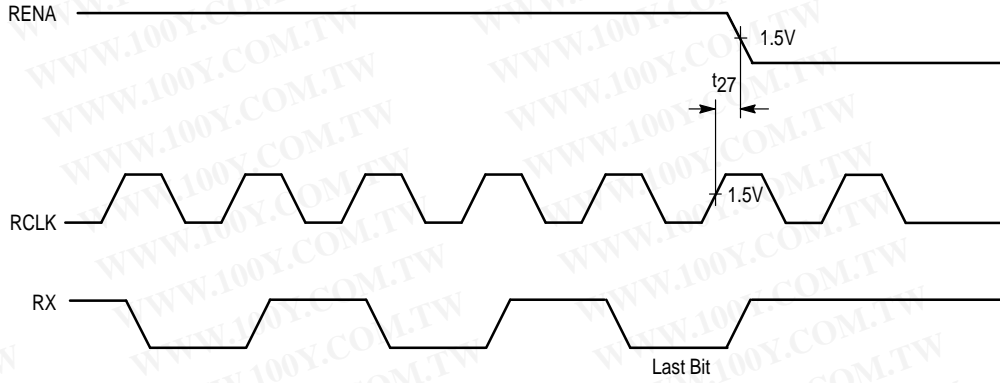

CONTROLLER TRANSMIT SWITCHING (Intel Mode – Support by MC68160 Only)

Characteristic	Symbol	Min	Max	Unit
TXC Cycle Time	t40	99	101	ns
TXC High and Low Time	t41	40	–	–
TXC Rise and Fall Time	t42	–	5.0	–
TXD Setup Time to TXC ↓	t43	20	–	ns
TXD Hold Time to TXC ↓	t44	0	–	–
RTS Setup Time to TXC ↓	t45	20	–	ns
RTS Hold Time to TXC ↓	t46	0	–	–

CONTROLLER RECEIVE SWITCHING

RXC Cycle Time	t80	90	–	ns
RXC High Time	t81	45	55	–
RXC Low Time	t82	40	–	–
RXC Rise and Fall Time	t83	–	5.0	–
RXD Hold Time from RXC ↓	t85	50	–	ns
RXD Set-Up Time to RXC ↓	t85.1	35	–	–
CRS Delay from RXC ↑	t86	12	30	–

NOTE: Load on specified output is 20 pF to ground, unless otherwise noted.
 ↑ = Rising Edge
 ↓ = Falling Edge

Figure 13. Transmit Timing (Intel)

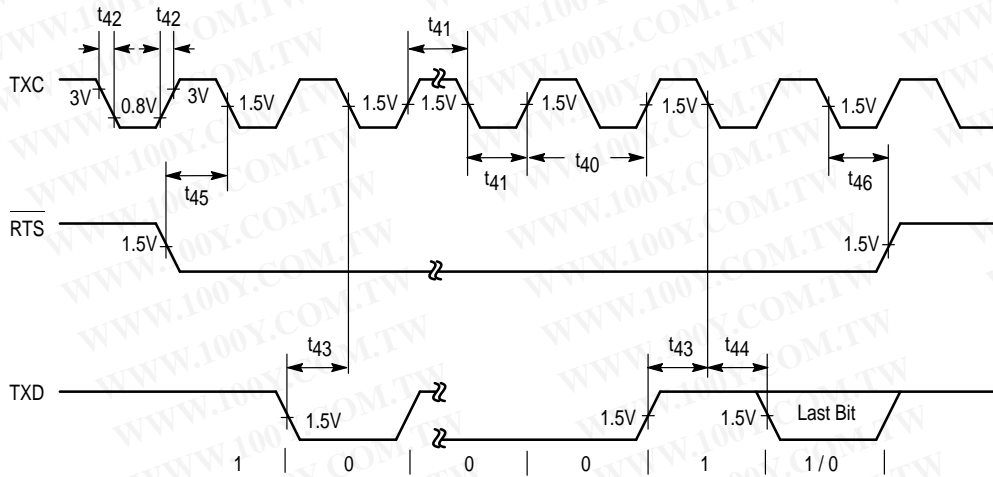

勝特力材料 886-3-5753170
 勝特力电子(上海) 86-21-34970699
 勝特力电子(深圳) 86-755-83298787
[Http://www.100y.com.tw](http://www.100y.com.tw)

MC68160 MC68160B MC68160C

Figure 14. Receive Timing (Intel)

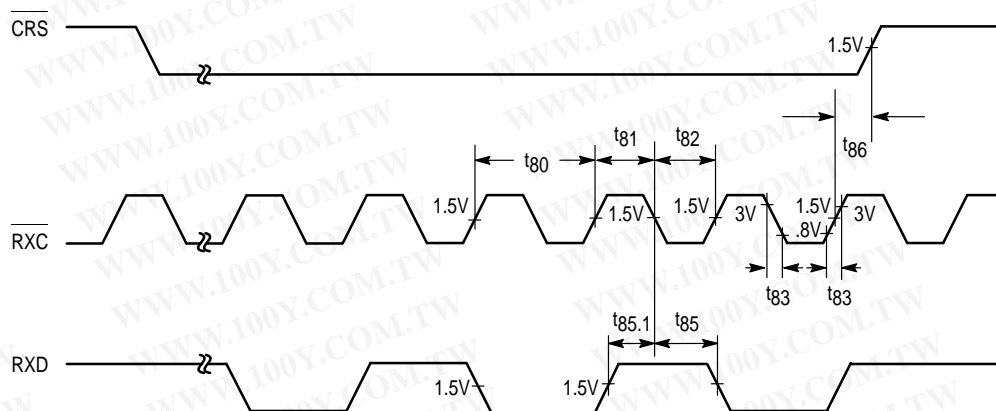

CONTROLLER TRANSMIT SWITCHING (Fujitsu Mode – Supported by MC68160 Only)

Characteristic	Symbol	Min	Max	Unit
TCKN Cycle Time	t_{90}	99	101	ns
TCKN High and Low Time	t_{91}	45	55	
TCKN Rise and Fall Time	t_{92}	–	8.0	
TXD Setup Time to TCKN ↓	t_{93}	20	–	ns
TXD Hold Time to TCKN ↓	t_{94}	0	–	
TEN Setup Time to TCKN ↓	t_{95}	20	–	ns
TEN Hold Time to TCKN ↓	t_{96}	0	–	

CONTROLLER RECEIVE SWITCHING

RCKN Cycle Time	t_{100}	90	–	ns
RCKN High Time	t_{101}	40	–	
RCKN Low Time	t_{102}	45	55	
RCKN Rise and Fall Time	t_{103}	–	8.0	
RXD Hold Time from RCKN ↓	t_{104}	50	–	ns
RXD Set-Up Time RCLK ↓	$t_{104.1}$	35	–	
RCKN Delay from XCD ↑	t_{105}	–	600	
XCD Deassertion Delay from RCKN ↑ (See Figure 17)	t_{106}	0	–	ns

NOTE: Load on specified output is 20 pF to ground, unless otherwise noted.

↑ = Rising Edge
 ↓ = Falling Edge

Figure 15. Transmit Timing (Fujitsu)

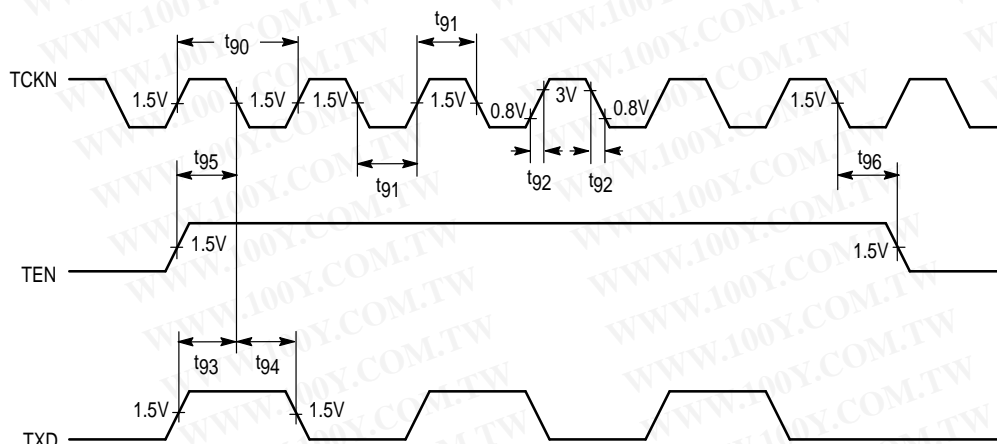

MC68160 MC68160B MC68160C

Figure 16. Receive Timing (Fujitsu Start of Frame)

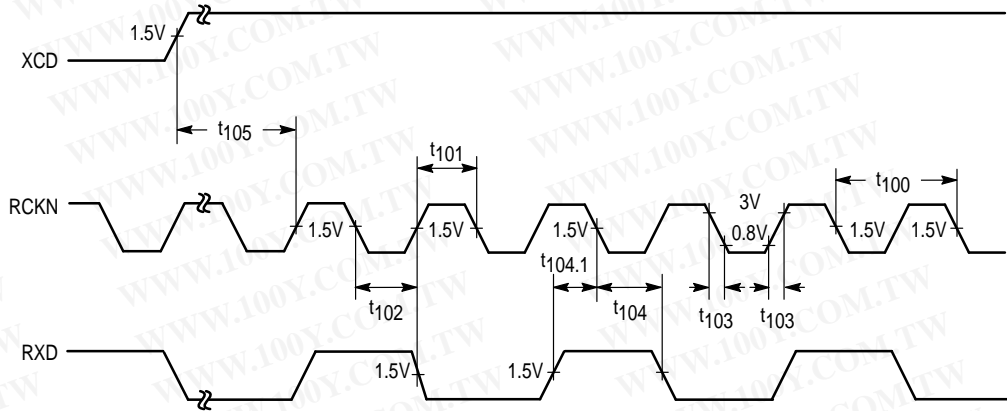
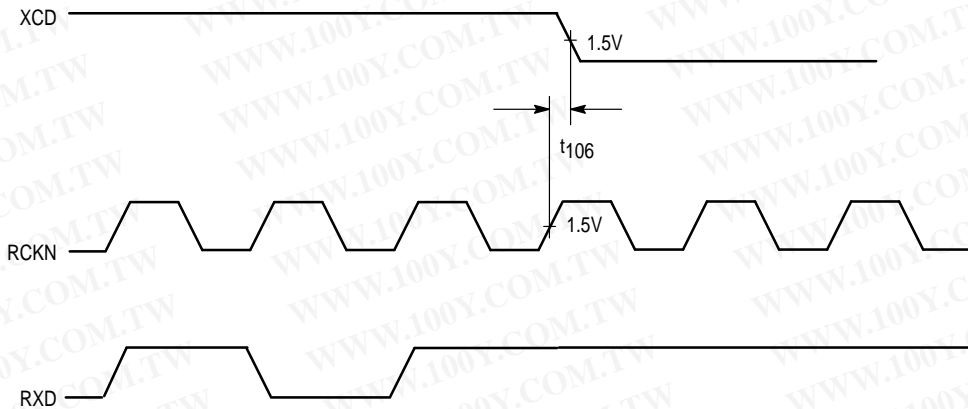

Figure 17. Receive Timing (Fujitsu End of Frame)



CONTROLLER TRANSMIT SWITCHING (National Mode – Supported by MC68160 Only)

Characteristic	Symbol	Min	Max	Unit
TXC Cycle Time	t110	99	101	ns
TXC High and Low Time	t111	45	55	
TXC Rise and Fall Time	t112	–	8.0	
TXD Setup Time to TXC ↑	t113	20	–	ns
TXD Hold Time to TXC ↑	t114	0	–	
TXE Setup Time to TXC ↑	t115	20	–	ns
TXE Hold Time to TXC ↑	t116	0	–	

CONTROLLER RECEIVE SWITCHING

RXC Cycle Time	t120	90	–	ns
RXC Low Time	t121	40	–	
RXC High Time	t122	40	60	
RXC Rise and Fall Time	t123	–	8.0	
RXD Hold Time from RXC ↑	t124	50	–	ns
RXD Set-Up Time from RXC ↑	t124.1	35	–	
RXC Delay from CRS ↑	t125	–	600	
CRS Deassertion Delay from RXC ↓	t126	0	15	ns
RXC continuing beyond CRS ↓	t127	5.0	–	cycles

NOTE: Load on specified output is 20 pF to ground, unless otherwise noted.
 ↑ = Rising Edge
 ↓ = Falling Edge

勝特力材料 886-3-5753170
 勝特力电子(上海) 86-21-34970699
 勝特力电子(深圳) 86-755-83298787
[Http://www.100y.com.tw](http://www.100y.com.tw)

MC68160 MC68160B MC68160C

Figure 18. Transmit Timing (National)

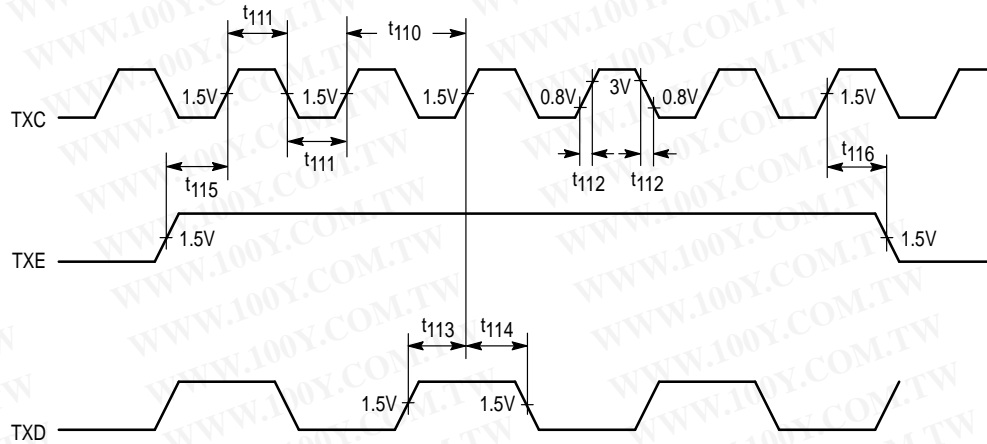
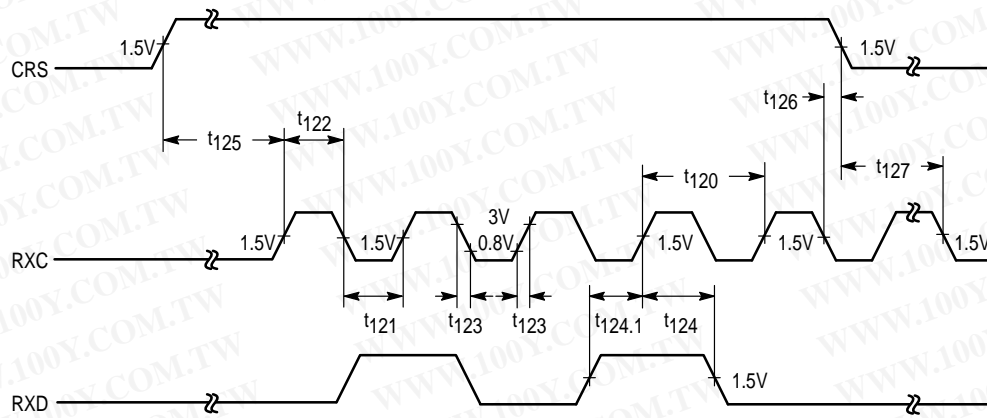

Figure 19. Receive Timing (National)



勝特力材料 886-3-5753170
 勝特力电子(上海) 86-21-34970699
 勝特力电子(深圳) 86-755-83298787
[Http://www.100y.com.tw](http://www.100y.com.tw)

MC68160 MC68160B MC68160C

TP TRANSMIT SWITCHING

Characteristic	Symbol	Min	Typ	Max	Unit
TPTX Common Mode AC Output Voltage (Note 3)	VOCMTP	–	–	50	mVrms
TX to TPTX Steady State Propagation Delay (Note 2) (See Figure 24) Bit Duration Center-to-Center Half-Bit Cell Duration Center-to-Boundary	t ₁₃₀ t ₁₃₁ t ₁₃₂	– 98 48	– – –	200 102 52	ns
TENA Assert to RENA Assert Delay (Note 7) (See Figure 24)	t ₁₃₃	–	–	400	ns
Internal Loopback Delay from TX to RX (Note 7) (See Figure 24) (MC68160, MC68160C) (MC68160B)	t ₁₃₄ t ₁₃₄	– –	– –	450 650	ns
TPTX End of Packet Hold Time from last positive TPTX Signal Edge to +585 mV Differential Output Level (Note 5) (See Figure 25)	t ₁₃₅	250	–	400	ns
TPTX Precompensation Pulse Width (Notes 2 and 6) (See Figure 25) (MC68160, MC68160C) (MC68160B)	t ₁₃₆ t ₁₃₆	– –	45–58 38–58	– –	ns
RENA Deassert Delay from TENA Deassert when Receiver is inactive Motorola Mode (MC68160, MC68160C) Motorola Mode (MC68160B) Fujitsu Mode (MC68160 Only) National Mode (MC68160 Only) Intel Mode (Note 4) (See Figure 26) (MC68160 Only)	t ₁₃₇ t ₁₃₇ t ₁₃₇ t ₁₃₇ t ₁₃₈	250 250 250 250 250	– – – – –	450 500 450 450 450	ns
TPTX Data-to-Link Test Pulse (Note 2) (See Figure 27)	t ₁₃₉	8.0	–	24	ms
TPTX Link Test Pulse Width (Note 2)	t ₁₄₀	80	–	240	ns
TPTX Link Test Pulse Decay-to-Idle Condition (Note 1)	t ₁₄₁	80	–	240	ns
TPTX Link Test Pulse to next Link Test Pulse (Note 2)	t ₁₄₂	8.0	–	24	ms

- NOTES:**
1. Measured differentially across the output of Test Load A which is connected directly to the TPTX+/- pins of the device.
 2. Measured differentially across the output of Test Load D shown in Figure 23 which is connected directly to the TPTX+/- pins of the device.
 3. Measured across the output of Test Load C which is connected directly to the TPTX+/- pins of the device.
 4. Same as t₁₃₇ except the logic states for TENA and RENA are inverted.
 5. Measured across the output of Test Load B shown in Figure 21.
 6. Measured at the +/-90% points of the precompensation voltage feature of the waveform. (The 0% reference is 0 V differential.)
 7. Load on specified output is 20 pF to ground.

Figure 20. Test Load A

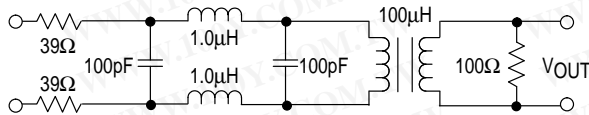

Figure 21. Test Load B

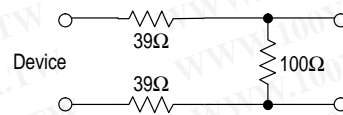

Figure 22. Test Load C

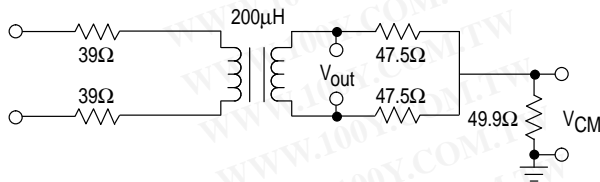
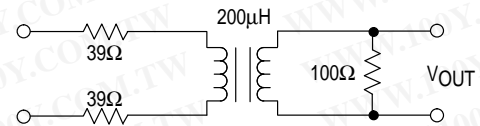

Figure 23. Test Load D



NOTE: A total of 50 Ω per driver output is required for proper series line termination. This is realized with the 39 Ω external resistors shown in Figures 20 to 23, together with the internal driver output resistance.

勝特力材料 886-3-5753170
 胜特力电子(上海) 86-21-34970699
 胜特力电子(深圳) 86-755-83298787
[Http://www.100y.com.tw](http://www.100y.com.tw)

MC68160 MC68160B MC68160C

Figure 24. TPTX Transmit Timing (Start of Frame) Switching

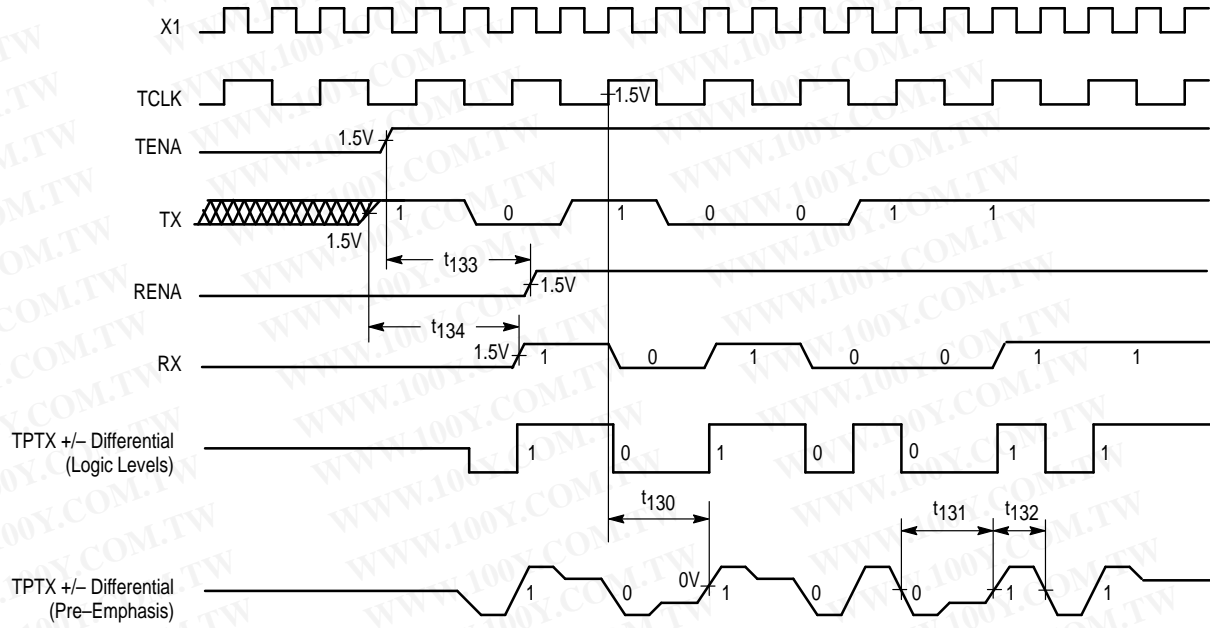

Figure 25. TPTX Transmit Timing (End of Frame) Switching

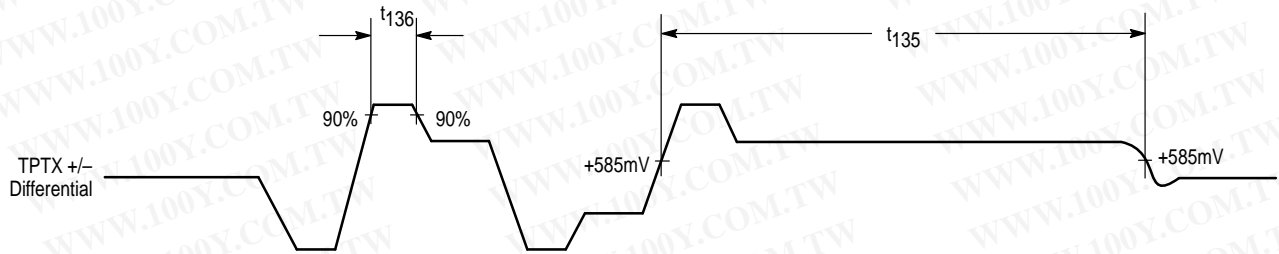
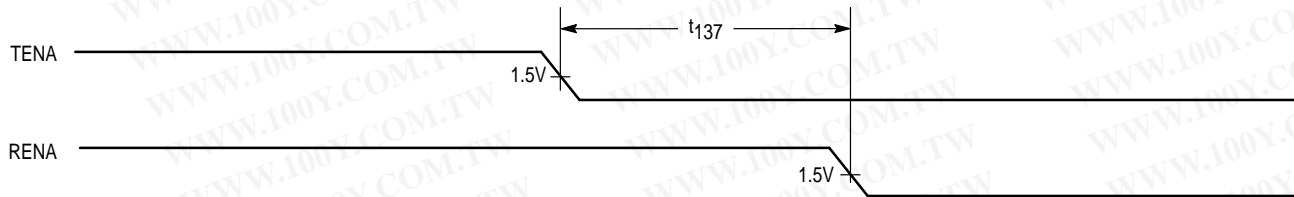

Figure 26. RENA Deassert Delay from TENA



勝特力材料 886-3-5753170
 勝特力电子(上海) 86-21-34970699
 勝特力电子(深圳) 86-755-83298787
[Http://www.100y.com.tw](http://www.100y.com.tw)

MC68160 MC68160B MC68160C

Figure 27. TPTX+/- Link Pulse Timing

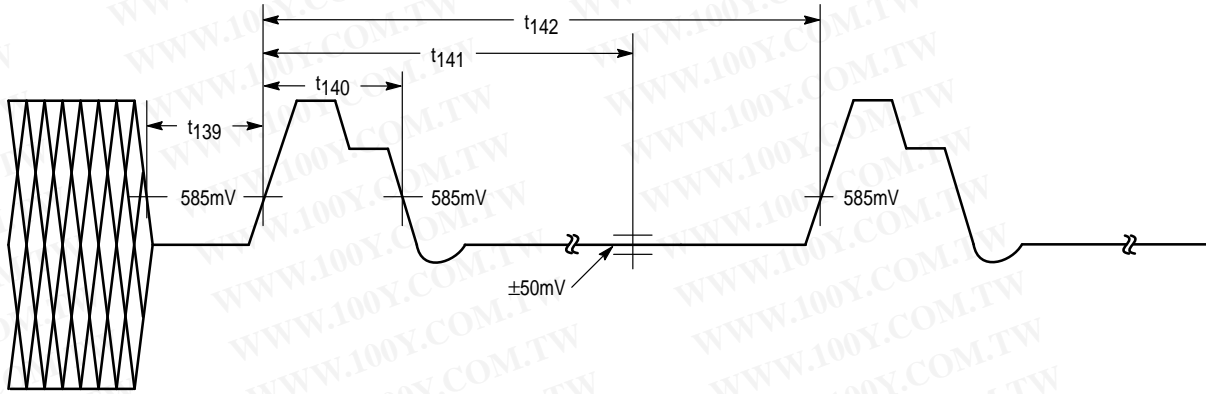

TP TRANSMIT JABBER SWITCHING

Characteristic	Symbol	Min	Max	Unit
Max Length of Transmission before Assertion of TPJABB to indicate Jabber Condition CLSN to indicate Jabber Condition	t_{160} t_{161}	20 20	60 60	ms
Time from End of Jabber Condition to Deassertion: of TPJABB of CLSN	t_{162} t_{163}	500 500	750 750	ms

TP TRANSMIT SIGNAL QUALITY ERROR TEST SWITCHING

CLSN (Signal Quality Error Test) (See Figure 29) Assertion from last positive TPTX edge Deassertion from last positive TPTX edge Pulse Width	t_{170} t_{171} t_{172}	0.6 - 0.5	1.6 3.1 1.5	μ s
TPSQEL Disable Delay Time (See Figure 29)	t_{173}	-	40	ns

NOTE: The load attached to the specified output is a 20 pF capacitor connected to ground, unless otherwise noted.

Figure 28. TPJABB Switching

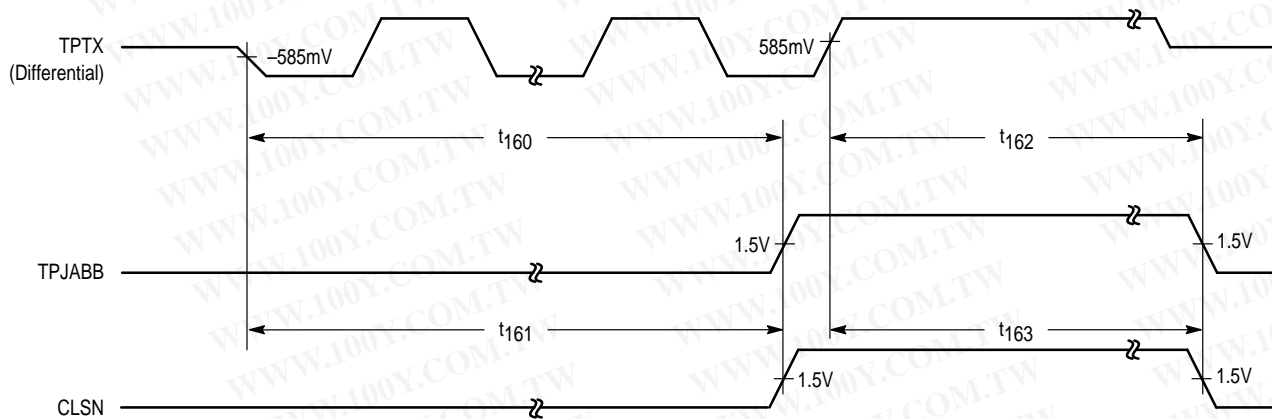

勝特力材料 886-3-5753170
 勝特力电子(上海) 86-21-34970699
 勝特力电子(深圳) 86-755-83298787
[Http://www.100y.com.tw](http://www.100y.com.tw)

MC68160 MC68160B MC68160C

Figure 29. TPTX SQE (CLSN) Timing (End of Frame)

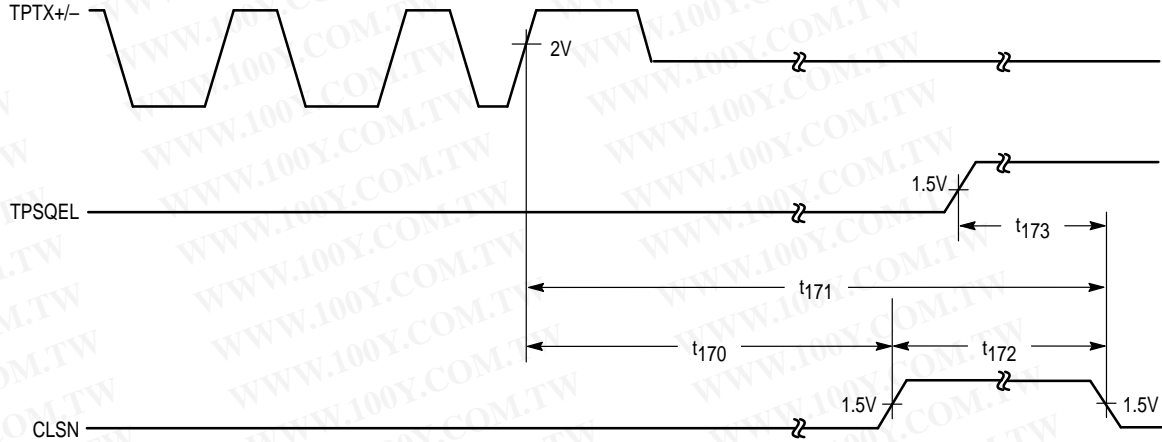

TP RECEIVE SWITCHING

Characteristic	Symbol	Min	Max	Unit
Differential Input Voltage Range Unconditional Squelch (Note 1) (1.8 V < Input Common Mode Voltage < 3.2 V)	V _{IDFSTP}	0	264	mV
Positive or Negative Differential Input Pulse Width for Conditional Receive Unsquelch (See Figure 31)	t ₁₈₀	20	30	ns
TPRX to RCLK Bit Loss at start of packet (See Figure 32)	t ₁₈₁	–	10	Bits
TPRX to RCLK Steady State Propagation Delay (See Figure 32)	t ₁₈₂	–	400	ns
TPRX to RX Start Up Delay (See Figure 32)	t ₁₈₃	–	1.5	μs
TPRX held high from last valid positive transition (See Figure 33)	t ₁₈₆	230	–	ns
RENA Deassertion Delay from last valid positive transition of TPRX Pair (MC68160, MC68160C) (See Figure 33)	t ₁₈₇	–	350	ns
RENA Deassertion Delay from last valid positive transition of TPRX Pair (MC68160B)	t ₁₈₇	–	400	ns

TP RECEIVE LINK INTEGRITY SWITCHING

Required Pulse Width Range to be recognized as a Link Pulse (Note 2)	t ₂₀₀	50	200	ns
Last TPRX activity to high state TPLIL Output (Receive Link Loss Timeout Interval)	t ₂₀₁	100	150	ms
Receive Link Beat Separation Minimum Range (Note 3) Maximum Range (Note 4)	t ₂₀₂ t ₂₀₃	3.0 100	7.0 150	ms

- NOTES:**
1. Measured with Test Load H attached to the receive pins.
 2. Measured at the receive pins.
 3. Link beats closer in time to this range of values are considered noise, and are rejected.
 4. Link beats further apart in time than this range of values are not considered consecutive, and are rejected.

Figure 30. Test Load H

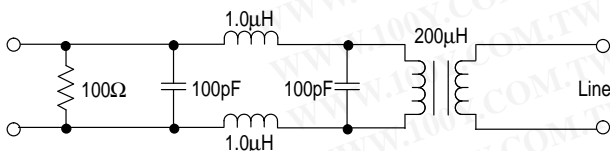
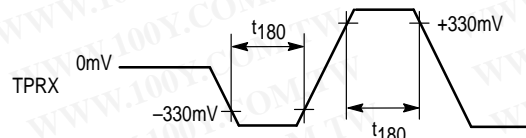

Figure 31. TPRX Input Switching



勝特力材料 886-3-5753170
 勝特力电子(上海) 86-21-34970699
 勝特力电子(深圳) 86-755-83298787
[Http://www.100y.com.tw](http://www.100y.com.tw)

MC68160 MC68160B MC68160C

Figure 32. TPRX Receive Timing (Start of Frame)

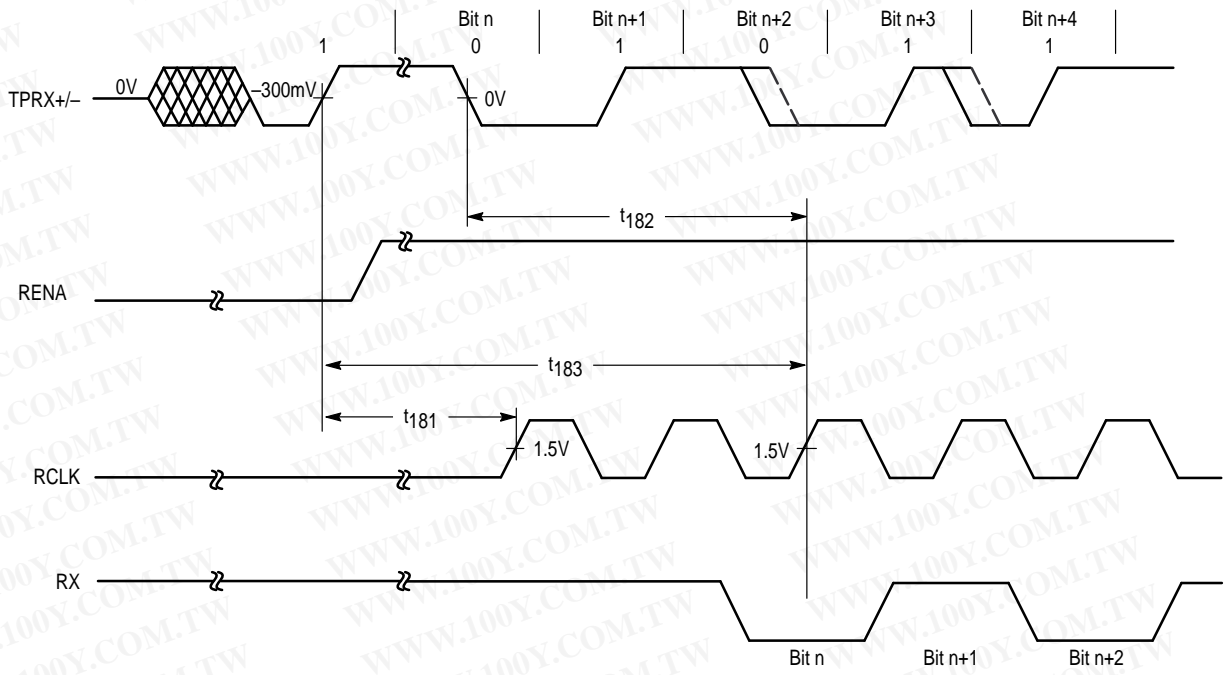

Figure 33. RENA Deassertion Delay from Last Valid Positive Transition of TPRX Pair

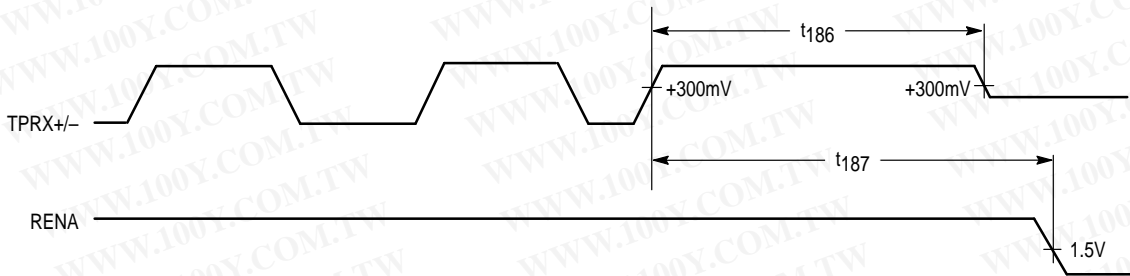
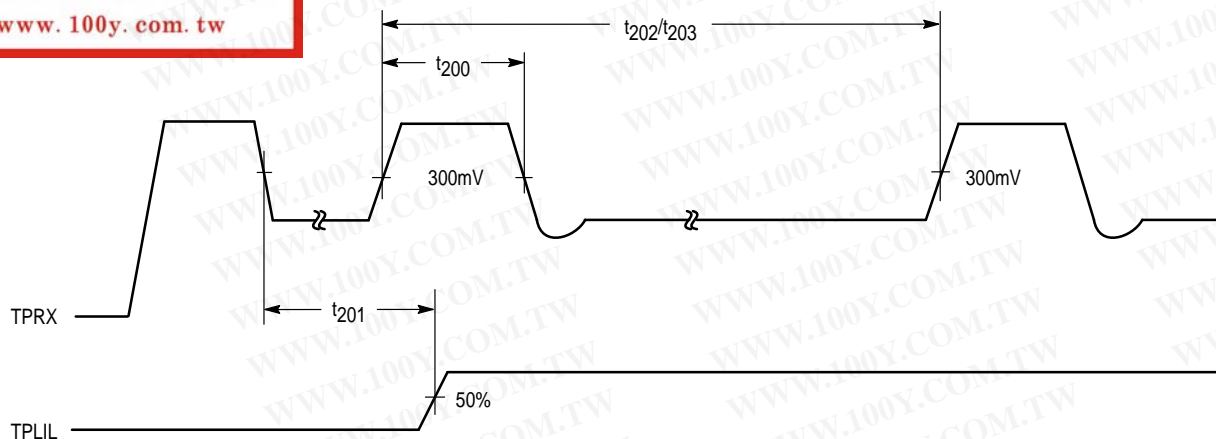

Figure 34. TP Receive Link Integrity Switching



勝特力材料 886-3-5753170
 勝特力电子(上海) 86-21-34970699
 勝特力电子(深圳) 86-755-83298787
[Http://www.100y.com.tw](http://www.100y.com.tw)

MC68160 MC68160B MC68160C

TP COLLISION SWITCHING

Characteristic	Symbol	Min	Max	Unit
Time from collision (TPRX activity caused assertion of RENA followed by assertion of TENA) to assertion of CLSN	t_{210}	–	300	ns
Time from end of collision (Deassertion of TENA with uninterrupted TPRX pair activity) to deassertion of CLSN	t_{211}	350	900	ns

TP FULL DUPLEX SWITCHING

TPFULDL assert to collision detect disable (See Figure 36)	t_{220}	–	50	ns
TPFULDL deassert to collision detect enable	t_{221}	–	50	ns
TPFULDL assert to data loop back disable (See Figure 37)	t_{222}	–	350	ns
TPFULDL deassert to data loop back enable	t_{223}	–	150	ns

NOTE: Load on specified output is 20 pF to ground, unless otherwise noted.

Figure 35. TPTX Collision Timing

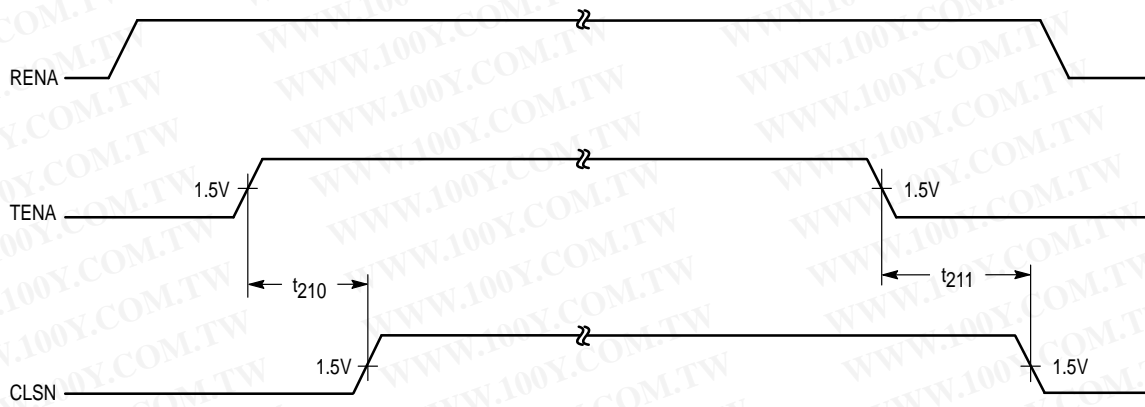

Figure 36. TPTX Full Duplex Timing

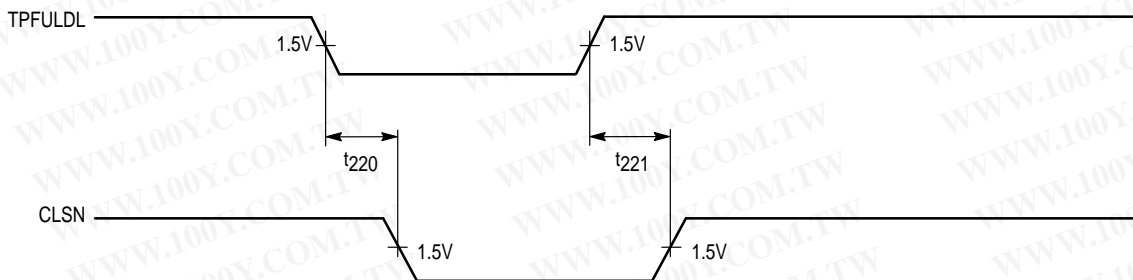
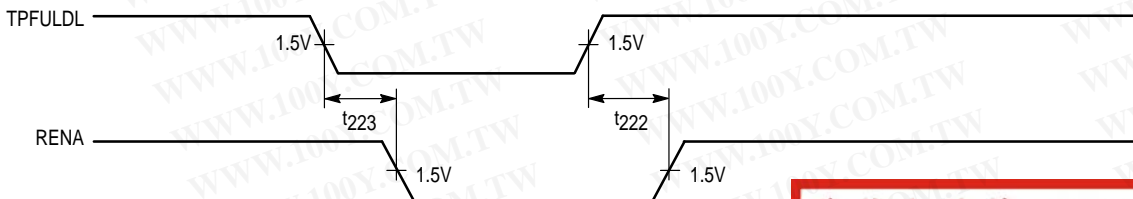

Figure 37. TPTX Full Duplex Timing



勝特力材料 886-3-5753170
 勝特力电子(上海) 86-21-34970699
 勝特力电子(深圳) 86-755-83298787
[Http://www.100y.com.tw](http://www.100y.com.tw)

MC68160 MC68160B MC68160C

AUI TRANSMIT SWITCHING

Characteristic	Symbol	Min	Typ	Max	Unit
TCLK to ATX Pair Steady State Propagation Delay	t_{240}	–	–	100	ns
Output Differential Rise and Fall Times (Measured directly at device pins)	t_{241}	1.0	–	5.0	ns
ATX Bit Cell Duration center-to-center (Measured directly at device pins)	t_{242}	–	99.5–100.5	–	ns
ATX Half-Bit Cell Duration center-to-boundary (Measured directly at device pins)	t_{243}	–	49.5–50.5	–	ns
ATX Pair Held at Positive Differential at start of Idle (Measured through transformer)	t_{244}	200	–	–	ns

NOTE: Load on specified output is a shunt 27 μ H inductor and 83 Ω resistor.

Figure 38. ATX Transmit Timings

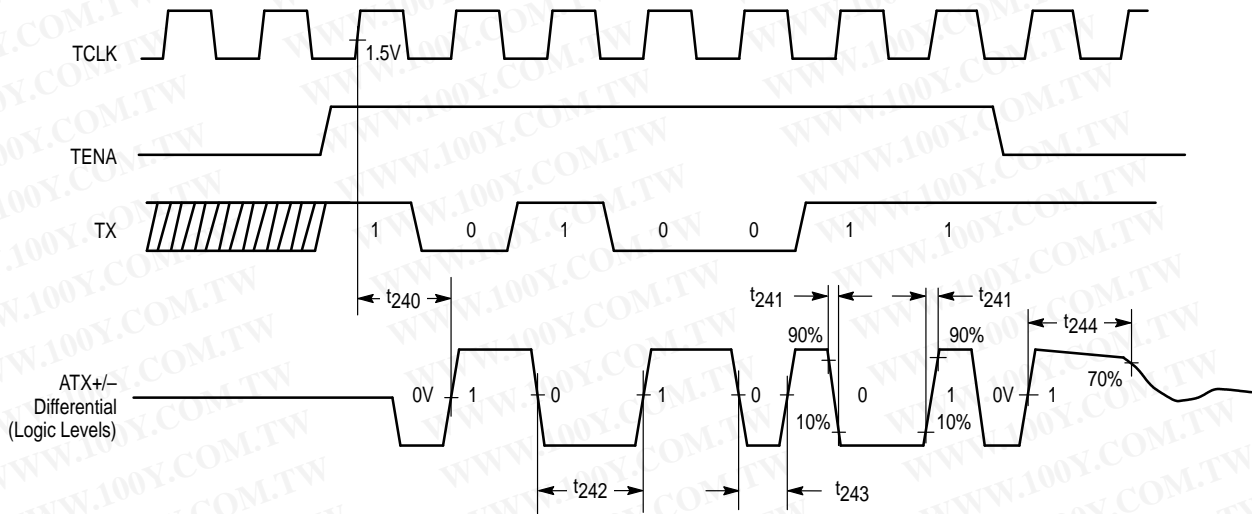

AUI RECEIVE SWITCHING

Characteristic	Symbol	Min	Max	Unit
ARX/ACX Differential Input Voltage Range	–	± 318	± 1315	mV
ARX/ACX Differential Input Pulse Width to: Initiate Data Reception	t_{261}	30	–	ns
Inhibit Data Reception	t_{262}	–	18	ns
RENA Assertion Delay	t_{266}	–	100	ns
RENA Deassertion Delay	t_{267}	–	450	ns

Squelching Characteristics

The receive data pairs and the collision pairs should have the following squelch characteristics:

1. The squelch circuits are on at idle (with input voltage at approximately 0 V differential).
2. If an input is in squelch, pulse is rejected if the peak differential voltage is more positive than -175 mV, regardless of pulse width.
3. A pulse is considered valid if its peak differential voltage is more negative than -300 mV and its width, measured at -285 mV, is > 25 ns.
4. The squelch circuits are disabled by the first valid negative differential pulse on either the AUI receive data or collision pair.
5. If a positive differential pulse occurs on either the AUI receive data or collision pair > 175 ns, end of frame is assumed and squelch circuitry is turned on.

Figure 39. ARX/ACX Timing

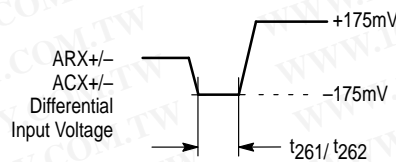

勝特力材料 886-3-5753170
 勝特力电子(上海) 86-21-34970699
 勝特力电子(深圳) 86-755-83298787
[Http://www.100y.com.tw](http://www.100y.com.tw)

Figure 40. ARX/ACX Timing

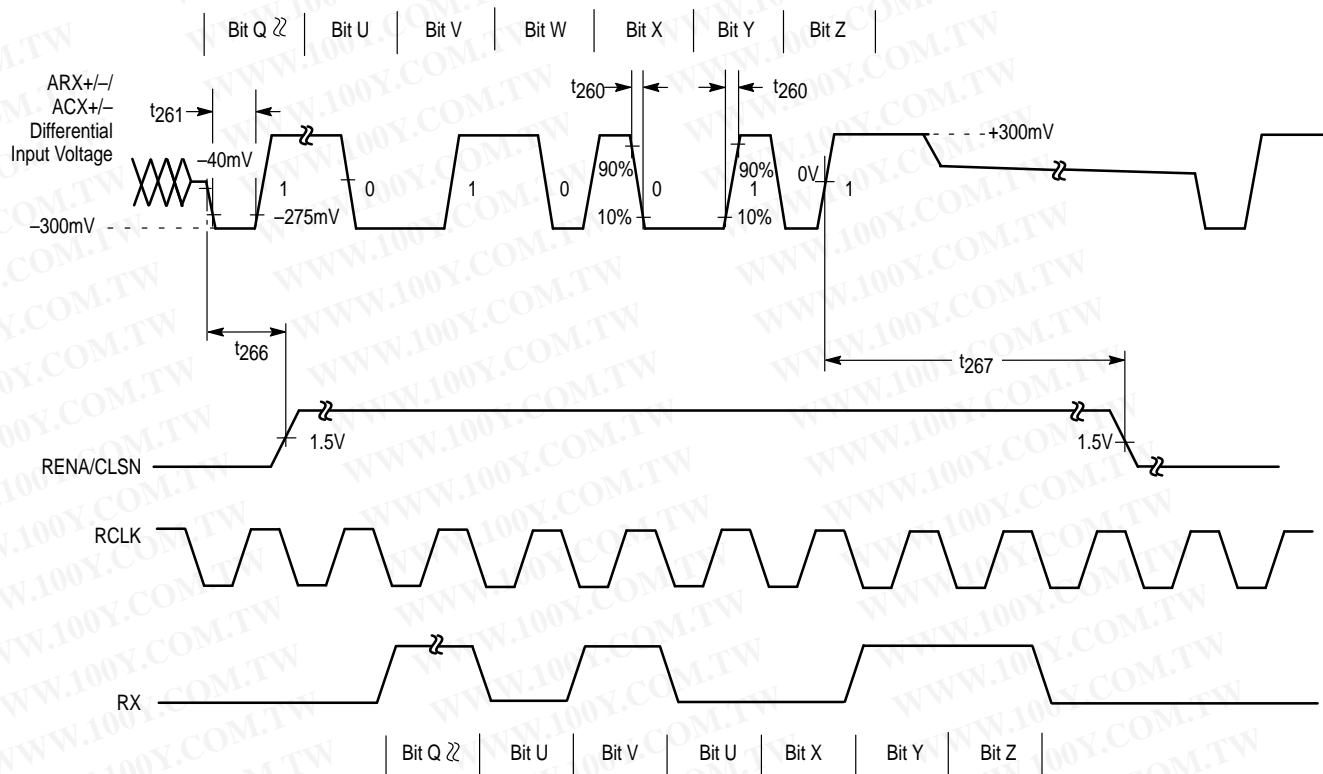

FUNCTIONAL DESCRIPTION

Introduction

The MC68160, B, C (EEST) was designed to perform the physical connection to the Ethernet media. This is done through two separate media dependent interfaces and a SIA interface. The media dependent interfaces are the Attachment Unit Interface(AUI) and the 10BASE-T Twisted Pair(TP) port. The MC68160's SIA interface is compatible with most industry controllers and selected by three mode control pins. The MC68160B's and MC68160C's SIA interface supports the Motorola MC68360 only. Chip status is supported on all versions indicated by the condition of 6 status indicator pins. All but one are open collector outputs.

If the EEST isn't receiving data, the controller may initiate transmission. NRZ data from the communications controller SIA interface is encoded by the MC68160, B, or C into Manchester Code in preparation for transmission on the media. The data is then applied to either the AUI or TP port. If the data was transmitted using the 10BASE-T port, this data is also looped back to the receive data interface SIA pins connected to the controller. This allows detection of a collision condition in the event that another station on the media attempted transmission at the same time. After the entire data frame has been transmitted, the EEST must force the media idle signal. The idle signal frees the media for other stations that have deferred transmission. If no other transmissions are required the link enters an idle state. During this idle state the 10BASE-T transmitter issues idle pulses which communicates to the receiver

connected to the other side that the link is valid. If the transmitter connected at the other end begins transmission, the EEST will assert a receive enable signal, and forward the received data to the controller.

Upon reception of data at the 10BASE-T port, the data is screened for proper sequence and pulse width requirements. If the preamble of the received frame meets the requirements, the PLL locks onto the 64-bit preamble and begins to decode the Manchester Code to NRZ code. This code is then presented to the communications controller at the receive data pins at the SIA interface. If data is received at the AUI port, it is sent directly to the communications controller via the SIA interface.

Data Transmission

To have properly encoded transmit data, the communications controller must be synchronized to TCLK. Transmission to the 10BASE-T or AUI media occurs when TENA is asserted and data is applied to the TX pin. Finally, to signify transmission, the TXLED in will cycle on and off at a 100 ms period. Data transmission for EEST is accomplished either over the 10BASE-T port or the AUI port. Both connections to the media are made with industry standard media interface components. The 10BASE-T interface requires a filter and transformer, the AUI interface requires only a transformer. The filter for the 10BASE-T transmit circuit will have to be chosen for each application.

MC68160 MC68160B MC68160C

If after approximately 40 ms after a TP or AUI transmission has begun, the EEST is still transmitting, the TPJABB pin will assert to signify a jabber condition. Also, the CLLED pin will transition high and low alternately with a 100 ms period. The transmit circuitry is, however, unaffected by the jabber condition, so the communications controller has the responsibility of monitoring and stopping transmission.

When transmission is complete, the transmit circuitry will begin the end of transmit and decay to idle responses necessary to meet requirements of the 802.3 standard for the TP and AUI port.

Data Reception

Other than the case of being in Loop Back mode, data reception to the RX pin of the EEST is initiated by signaling at the RX+/- or AUI ARX+/- pins. If at the TP port, the data is screened for validity by checking for sequence and pulse width requirements, then passed to the decode and receive circuitry. The RENA pin asserts and the data and corresponding clock is passed to the communications controller. After the frame has been transmitted, the MC68160, B and C detects the ending transmission and negates RENA. If at the AUI port, the data is checked for proper pulse width requirements before being passed to the decode circuitry. If the data pulses are longer than at least 20 ns, RENA gets asserted and the frame is decoded to RX with accompanying RCLK output.

Collision

Collision is the occurrence of simultaneous transmit activity by two or more stations on the network. In the event of collision, the data transfer paths are unaffected. If the MC68160, B and C is in the twisted pair mode, collision is detected by simultaneous receive and transmit activity. If in the AUI mode, collision is detected by activity on the ACX+/- pins. In either case, if collision is detected, the CLSN pin will assert to notify the communications controller.

Jabber

The EEST has a jabber timer to detect the jabber condition. In the event that the transmitting station continues to transmit beyond the allowable transmit time, a jabber timer (40 ms) will expire and assert the TPJABB pin to alert the communications

controller of the situation. The TPJABB pin can source or sink up to 10 mA, and so, is capable of driving a status LED. In the AUI mode, the pin is driven to high impedance since the transceiver connected to the AUI port must alert the communications controller of the jabber condition.

Full Duplex

A feature unique to the MC68160, B and C is the Full Duplex mode. In this mode the EEST is capable of transmitting and receiving simultaneously. Collision conditions are not announced and internal loop back is disabled. The remainder of the EEST functionality remains unchanged from the non-Full Duplex mode. Full Duplex mode is enabled by asserting the TPFULDL pin.

Auto Port Selection

If the APORT pin is asserted, the MC68160, B and C will automatically select the TP or AUI port depending on the presence of valid link beats or frames at the TP RX+/- pins. If the AUI port is automatically selected by another transmitting station or by setting TPEN low, the TP transmit port of the EEST continues to transmit link beats to keep the link active.

Auto Polarity Selection

If the RX+ and the RX- wires happen to get reversed, the MC68160, B and C has the ability to automatically reverse the pins internally so that the received data is valid. In addition, an open collector status pin (TPPLR) is driven low to indicate the fault. In the AUI or reset mode this pin presents a high impedance.

Loop Back Mode

To test the transmit and receive circuitry without disturbing the connected network, the EEST has a Loop Back mode. Loop Back mode routes transmit data and clock to the receive data and clock pins using as much of the transmit and receive circuitry as possible. This gives a test of the MC68160, B and C Manchester encode and decode function. LOOP must not be asserted when TPFULDL pin is asserted. This causes the MC68160, B and C to enter a test mode. This test mode is used during final test and is not intended to be entered under normal operation (see Application Notes section).

勝特力材料 886-3-5753170
勝特力电子(上海) 86-21-34970699
勝特力电子(深圳) 86-755-83298787
[Http://www.100y.com.tw](http://www.100y.com.tw)

MC68160 MC68160B MC68160C

APPLICATIONS INFORMATION

Selection of Crystal and External Components

Accuracy of frequency and stability over temperature are the main determinants of crystal choice. Specifications for a suitable crystal are tabulated below.

Frequency	20.000 MHz
Mode	Fundamental
Tolerance	± 100 ppm
Stability	± 100 ppm
Aging	± 5 ppm/yr
Shunt Capacitance	7.0 pF
Load Capacitance	18–20 pF
Series Fundamental Resistance (ESR)	25 Ω
Drive Level	500 μW

A suitable crystal is the MTRON HC49 MP-1, 20.000 MHz crystal. 20 pF for C4 and C5 have been shown to work reliably.

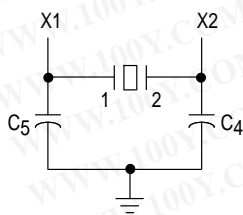

PLL Filter Components

The filter components at Pin 12 were chosen to assure adequate pull-range but with an emphasis on stability. It is not foreseeable that a design would need to change the components, but for the sake of completeness, relevant values are provided here.

$$\text{VCO Gain} = 24 \left(\frac{\text{MHz}}{\text{Volt} \cdot \text{sec}} \right) \text{ and,}$$

$$\text{Phase Detector Gain} = \frac{100}{\pi/2} \left(\frac{\mu\text{A}}{\text{rad}} \right) \text{ and the}$$

filter impedance function is;

$$Z(j\omega) \approx \frac{(j\omega + 1/C6)}{j\omega \cdot C5 \cdot (j\omega + 1/C5)} \text{ (for } C6 \gg C5)$$

10BASE-T Filter and Transformer Choice

The MC68160, B and C differential outputs are low impedance voltage sources. Therefore, external series resistors must be used in order to match the characteristic impedance of twisted pair. Since the output resistance of each leg of the transmitter is about 10 Ω, a 39 Ω resistor is used in series as shown in the applications schematic. So the impedance presented from the source to the isolation transformer is then very nearly 100 Ω. The following is a list of some 10BASE-T filter module vendors and their products.

Vendor	Part #
FEE Fil-Mag	78Z1120B-01, 78Z1122B/D-01, 78Z1122 F-01
Valor Electronics	PT3877, FL1012, FL1066
Pulse Engineering	PE-65434, PE65424, PE65433
TOKO	PM01-00, PM02-00, PM05-00

AUI Transformer Choice

Like the 10BASE-T outputs, the AUI differential outputs are low impedance sources and capable of meeting the IEEE 802.3 waveform requirements when a coupling transformer is used. Some AUI transformer vendors and their products are provided below.

Vendor	Part #
Coilcraft	LAX-ET304
FEE Fil-Mag	23Z90, 23Z91/ 23Z92
Valor Electronics	LT6032, LT6033
Pulse Engineering	PE64502, PE6103
TOKO	Q30ALQ8-1AA3, Q30ALQ9-1AA3

Application Notes:

The following procedure is applicable to all three versions MC68160, MC68160B and MC68160C. References to the MC68160 includes all the versions.

Resetting the MC68160 after power up.

In some applications, after initial power up, the MC68160 may not be able to transmit or receive data. This is usually caused by the LOOP and TPFULDL control lines being active at the same time. This is an illegal condition during normal operation, it places the MC68160 into the production test mode.

To exit the test mode and return to normal: Set LOOP low, TPFULDL high and TPSQEL low. Then, while keeping TPSQEL low, raise LOOP after 300 ms lower TPFULDL. This will put the MC68160 into test mode but also resets the MC68160. After 500 ms lower LOOP to get out of the test mode. TPFULDL may then be de-asserted if desired.

The MC68160 is now ready for operation.

A hardware implementation of this fix would be to place a pull down resistor on the TPSQEL pin. Even if test mode is entered by accident, this ensures that zero's will be written to the test register. The hardware implementation will solve the problem if the test mode is entered because of noise on the TPSQEL pin. If the controller is toggling the MC68160 lines while it is booting up, the reset procedure must be followed.

勝特力材料 886-3-5753170
 勝特力电子(上海) 86-21-34970699
 勝特力电子(深圳) 86-755-83298787

[Http://www.100y.com.tw](http://www.100y.com.tw)

Figure 41. Typical Application Diagram

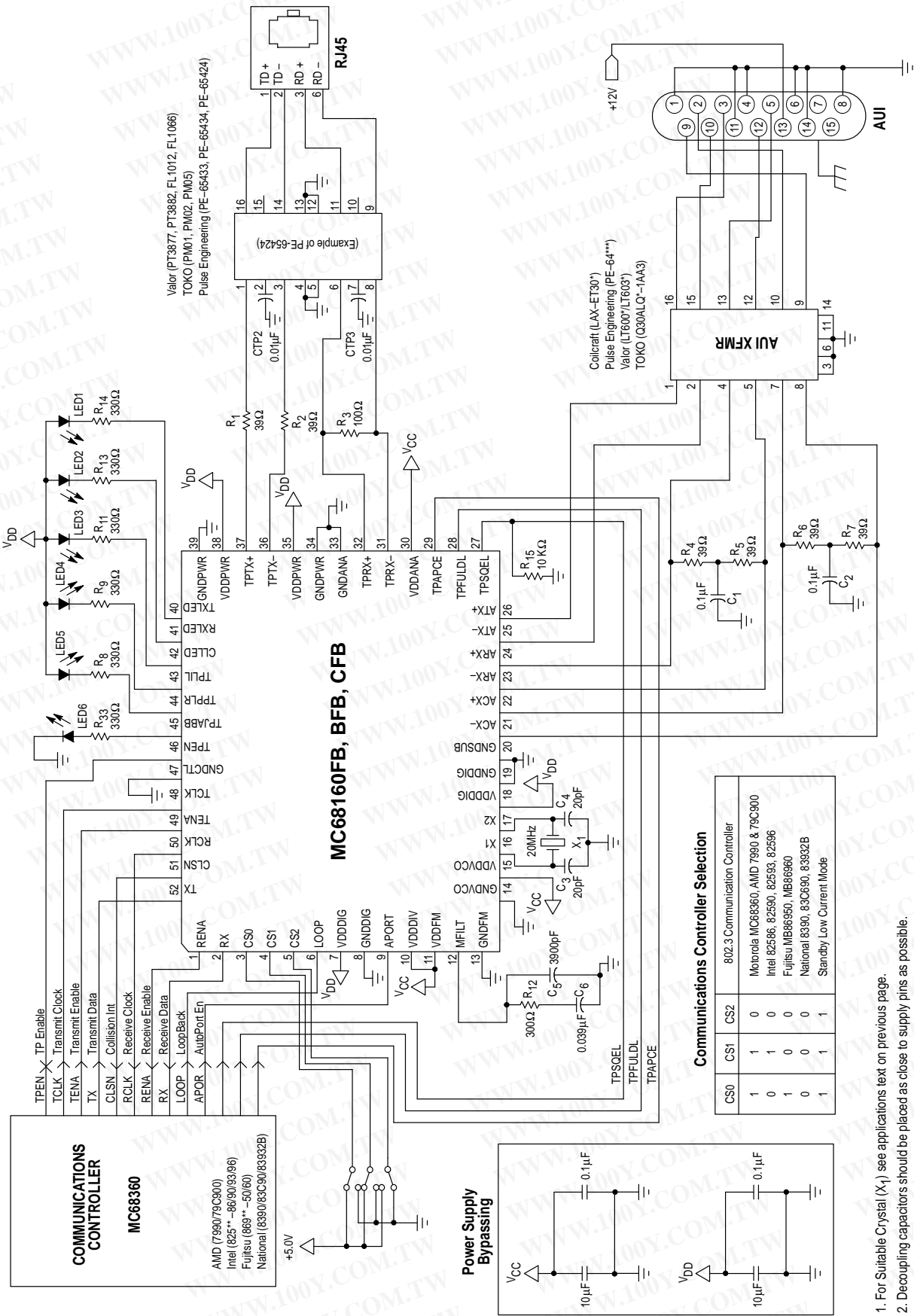

1. For Suitable Crystal (X₁) see applications text on previous page.
2. Decoupling capacitors should be placed as close to supply pins as possible.

勝特力材料 886-3-5753170
 勝特力电子(上海) 86-21-34970699
 勝特力电子(深圳) 86-755-83298787
[Http://www.100y.com.tw](http://www.100y.com.tw)

MC68160 MC68160B MC68160C

OUTLINE DIMENSIONS

FB SUFFIX
PLASTIC PACKAGE
CASE 848D-03
(TQFP-52)
ISSUE C

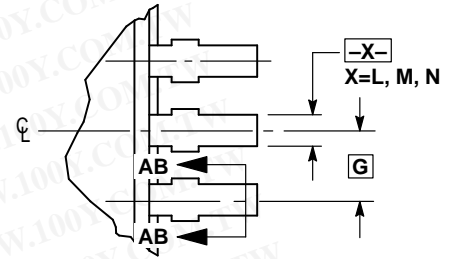
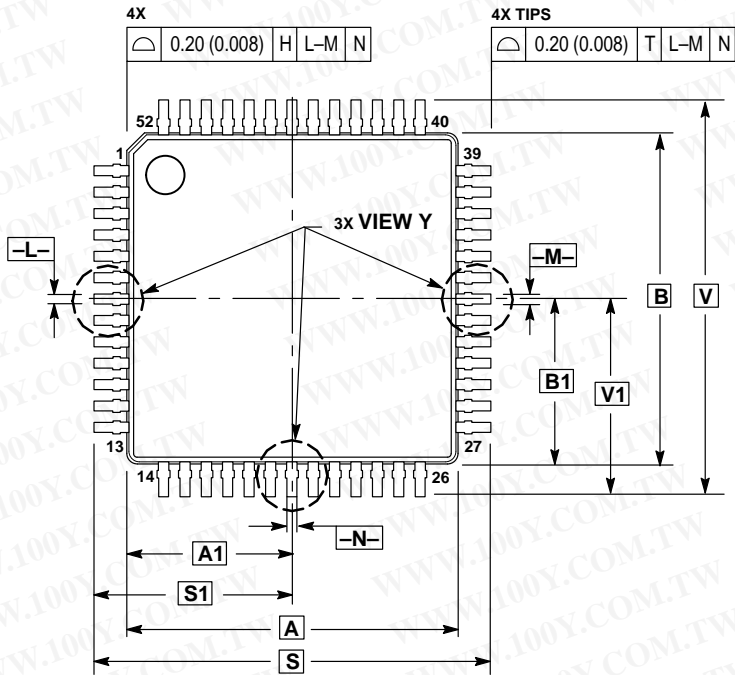

VIEW Y

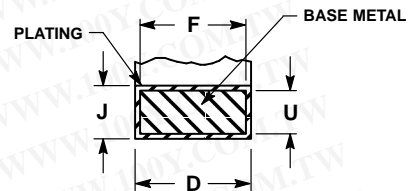

\oplus 0.13 (0.005) $\text{\textcircled{M}}$ T L-M $\text{\textcircled{S}}$ N $\text{\textcircled{S}}$

SECTION AB-AB
ROTATED 90° CLOCKWISE

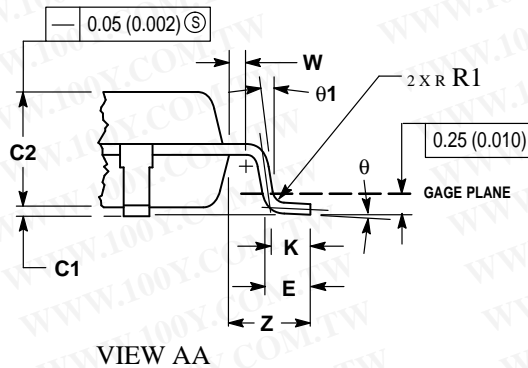
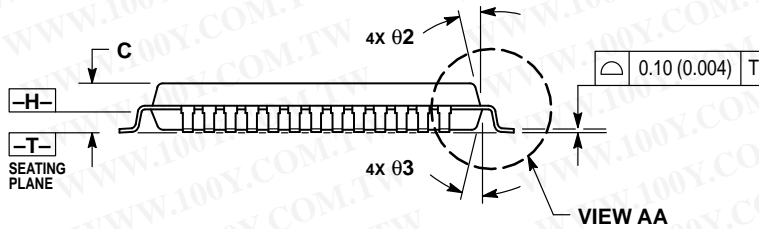

NOTES:

- 1 DIMENSIONING AND TOLERANCING PER ANSI Y14.5M, 1982.
- 2 CONTROLLING DIMENSION: MILLIMETER.
- 3 DATUM PLANE -H- IS LOCATED AT BOTTOM OF LEAD AND IS COINCIDENT WITH THE LEAD WHERE THE LEAD EXITS THE PLASTIC BODY AT THE BOTTOM OF THE PARTING LINE.
- 4 DATUMS -L-, -M- AND -N- TO BE DETERMINED AT DATUM PLANE -H-.
- 5 DIMENSIONS S AND V TO BE DETERMINED AT SEATING PLANE -T-.
- 6 DIMENSIONS A AND B DO NOT INCLUDE MOLD PROTRUSION. ALLOWABLE PROTRUSION IS 0.25 (0.010) PER SIDE. DIMENSIONS A AND B DO INCLUDE MOLD MISMATCH AND ARE DETERMINED AT DATUM PLANE -H-.
- 7 DIMENSION D DOES NOT INCLUDE DAMBAR PROTRUSION. DAMBAR PROTRUSION SHALL NOT CAUSE THE LEAD WIDTH TO EXCEED 0.46 (0.018). MINIMUM SPACE BETWEEN PROTRUSION AND ADJACENT LEAD OR PROTRUSION 0.07 (0.003).

DIM	MILLIMETERS		INCHES	
	MIN	MAX	MIN	MAX
A	10.00 BSC	—	0.394	0.008
A1	5.00 BSC	—	0.197	BSC
B	10.00 BSC	—	0.394	BSC
B1	5.00 BSC	—	0.197	BSC
C	—	1.70	—	0.067
C1	0.05	0.20	0.002	0.008
C2	1.30	1.50	0.051	0.059
D	0.20	0.40	0.008	0.016
E	0.45	0.75	0.018	0.030
F	0.22	0.35	0.009	0.014
G	0.65 BSC	—	0.026	BSC
J	0.07	0.20	0.003	0.008
K	0.50 REF	—	0.020	REF
R1	0.08	0.20	0.003	0.008
S	12.00 BSC	—	0.472	BSC
S1	6.00 BSC	—	0.236	BSC
U	0.09	0.16	0.004	0.006
V	12.00 BSC	—	0.472	BSC
V1	6.00 BSC	—	0.236	BSC
W	0.20 REF	—	0.008	REF
Z	1.00 REF	—	0.039	REF
θ	0°	7°	0°	7°
θ_1	0°	—	0°	—
θ_2	12° REF	—	12°	REF
θ_3	5°	13°	5°	13°

MC68160 MC68160B MC68160C

勝特力材料 886-3-5753170
勝特力电子(上海) 86-21-34970699
勝特力电子(深圳) 86-755-83298787
[Http://www.100y.com.tw](http://www.100y.com.tw)

Motorola reserves the right to make changes without further notice to any products herein. Motorola makes no warranty, representation or guarantee regarding the suitability of its products for any particular purpose, nor does Motorola assume any liability arising out of the application or use of any product or circuit, and specifically disclaims any and all liability, including without limitation consequential or incidental damages. "Typical" parameters which may be provided in Motorola data sheets and/or specifications can and do vary in different applications and actual performance may vary over time. All operating parameters, including "Typicals" must be validated for each customer application by customer's technical experts. Motorola does not convey any license under its patent rights nor the rights of others. Motorola products are not designed, intended, or authorized for use as components in systems intended for surgical implant into the body, or other applications intended to support or sustain life, or for any other application in which the failure of the Motorola product could create a situation where personal injury or death may occur. Should Buyer purchase or use Motorola products for any such unintended or unauthorized application, Buyer shall indemnify and hold Motorola and its officers, employees, subsidiaries, affiliates, and distributors harmless against all claims, costs, damages, and expenses, and reasonable attorney fees arising out of, directly or indirectly, any claim of personal injury or death associated with such unintended or unauthorized use, even if such claim alleges that Motorola was negligent regarding the design or manufacture of the part. Motorola and  are registered trademarks of Motorola, Inc. Motorola, Inc. is an Equal Opportunity/Affirmative Action Employer.

Mfax is a trademark of Motorola, Inc.

How to reach us:

USA/EUROPE/Locations Not Listed: Motorola Literature Distribution;
P.O. Box 5405, Denver, Colorado 80217. 303-675-2140 or 1-800-441-2447

JAPAN: Nippon Motorola Ltd.; Tatsumi-SPD-JLDC, 6F Seibu-Butsuryu-Center,
3-14-2 Tatsumi Koto-Ku, Tokyo 135, Japan. 81-3-3521-8315

Mfax™: RMFA0@email.sps.mot.com - TOUCHTONE 602-244-6609
- US & Canada ONLY 1-800-774-1848

ASIA/PACIFIC: Motorola Semiconductors H.K. Ltd.; 8B Tai Ping Industrial Park,
51 Ting Kok Road, Tai Po, N.T., Hong Kong. 852-26629298

INTERNET: <http://www.mot.com/SPS/>

