

Features

- 14A Peak Source/Sink Drive Current
- Wide Operating Voltage Range: 4.5V to 35V
- -40°C to +125°C Extended Operating Temperature Range
- Logic Input Withstands Negative Swing of up to 5V
- Low Propagation Delay Time
- Low, 10 μ A Supply Current
- Low Output Impedance

Applications

- Efficient Power MOSFET and IGBT Switching
- Switch Mode Power Supplies
- Motor Controls
- DC to DC Converters
- Class-D Switching Amplifiers
- Pulse Transformer Driver

Description

The IXDD614 / IXDI614 / IXDN614 high-speed gate drivers are especially well suited for driving the latest IXYS MOSFETs and IGBTs. Each output can source and sink 14A of peak current while producing voltage rise and fall times of less than 30ns. Internal circuitry eliminates cross-conduction and current "shoot-through," making the driver virtually immune to latch up. Low propagation delay with fast rise and fall times make the IXD_614 family ideal for high-frequency and high-power applications.



The IXDD614 is configured as a non-inverting driver with an enable. The IXDN614 is configured as a non-inverting driver, and the IXDI614 is configured as an inverting driver.

The IXD_614 family is available in an 8-pin DIP (PI), an 8-pin Power SOIC with an exposed metal back (SI), a 5-pin TO-220 (CI), and a 5-pin TO-263 (YI) package.

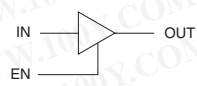

勝特力材料 886-3-5753170
 勝特力电子(上海) 86-21-34970699
 勝特力电子(深圳) 86-755-83298787
[Http://www.100y.com.tw](http://www.100y.com.tw)

Ordering Information

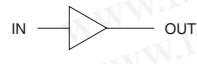
Part Number	Logic Configuration	Package Type	Packing Method	Quantity
IXDD614PI		8-Pin DIP	Tube	50
IXDD614SI		8-Pin Power SOIC with Exposed Metal Back	Tube	100
IXDD614SITR		8-Pin Power SOIC with Exposed Metal Back	Tape & Reel	2000
IXDD614CI		5-Pin TO-220	Tube	50
IXDD614YI		5-Pin TO-263	Tube	50
IXDI614PI		8-Pin DIP	Tube	50
IXDI614SI		8-Pin Power SOIC with Exposed Metal Back	Tube	100
IXDI614SITR		8-Pin Power SOIC with Exposed Metal Back	Tape & Reel	2000
IXDI614CI		5-Pin TO-220	Tube	50
IXDI614YI		5-Pin TO-263	Tube	50
IXDN614PI		8-Pin DIP	Tube	50
IXDN614SI		8-Pin Power SOIC with Exposed Metal Back	Tube	100
IXDN614SITR		8-Pin Power SOIC with Exposed Metal Back	Tape & Reel	2000
IXDN614CI		5-Pin TO-220	Tube	50
IXDN614YI		5-Pin TO-263	Tube	50

1. Specifications	3
1.1 Pin Configurations	3
1.2 Pin Definitions	3
1.3 Absolute Maximum Ratings	3
1.4 Recommended Operating Conditions	3
1.5 Electrical Characteristics: $T_A = 25^{\circ}\text{C}$	4
1.6 Electrical Characteristics: $T_A = -40^{\circ}\text{C}$ to $+125^{\circ}\text{C}$	5
1.7 Thermal Characteristics	6
2. Performance	6
2.1 Timing Diagrams	6
2.2 Characteristics Test Diagram	6
3. Block Diagrams & Truth Tables	7
3.1 IXDD614	7
3.2 IXDI614	7
3.3 IXDN614	7
4. Typical Performance Characteristics	8
5. Manufacturing Information	11
5.1 Moisture Sensitivity	11
5.2 ESD Sensitivity	11
5.3 Reflow Profile	11
5.4 Mechanical Dimensions	12
5.4.1 SI (8-Pin Power SOIC with Exposed Metal Back)	12
5.4.2 SI Package Tape & Reel Information	12
5.4.3 YI (5-Pin TO-263)	13
5.4.4 CI (5-Pin TO-220)	13
5.4.5 PI (8-Pin DIP)	14

1 Specifications

1.1 Pin Configurations

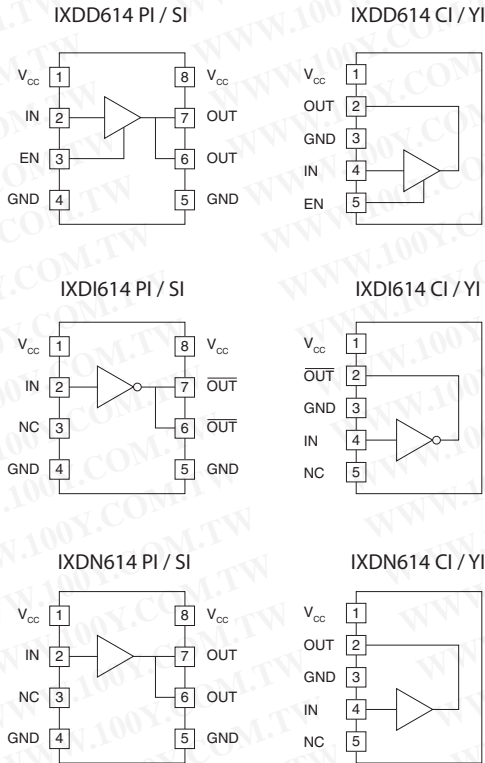

1.2 Pin Definitions

Pin Name	Description
IN	Logic Input
EN	Output Enable - Drive pin low to disable output, and force output to a high impedance state
OUT	Output - Sources or sinks current to turn-on or turn-off a discrete MOSFET or IGBT
$\overline{\text{OUT}}$	Inverted Output - Sources or sinks current to turn-on or turn-off a discrete MOSFET or IGBT
V _{CC}	Supply Voltage - Provides power to the device
GND	Ground - Common ground reference for the device
NC	Not connected

Note: IXYS Integrated Circuits Division recommends that the exposed metal pad on the back of the “SI” package be connected to GND. The pad is not suitable for carrying current.

1.3 Absolute Maximum Ratings

Parameter	Symbol	Minimum	Maximum	Units
Supply Voltage	V _{CC}	-0.3	40	V
Input Voltage	V _{IN} , V _{EN}	-5	V _{CC} +0.3	V
Output Current	I _{OUT}	-	±14	A
Junction Temperature	T _J	-55	+150	°C
Storage Temperature	T _{STG}	-65	+150	°C

Unless stated otherwise, absolute maximum electrical ratings are at 25°C

Absolute maximum ratings are stress ratings. Stresses in excess of these ratings can cause permanent damage to the device. Functional operation of the device at conditions beyond those indicated in the operational sections of this data sheet is not implied.

1.4 Recommended Operating Conditions

Parameter	Symbol	Range	Units
Supply Voltage	V _{CC}	4.5 to 35	V
Operating Temperature Range	T _A	-40 to +125	°C

1.5 Electrical Characteristics: $T_A = 25^\circ\text{C}$

 Test Conditions: $4.5\text{V} \leq V_{CC} \leq 35\text{V}$ (unless otherwise noted).

Parameter	Conditions	Symbol	Minimum	Typical	Maximum	Units
Input Voltage, High	$4.5\text{V} \leq V_{CC} \leq 18\text{V}$	V_{IH}	3.0	-	-	V
Input Voltage, Low	$4.5\text{V} \leq V_{CC} \leq 18\text{V}$	V_{IL}	-	-	0.8	
Input Current	$0\text{V} \leq V_{IN} \leq V_{CC}$	I_{IN}	-	-	± 10	μA
EN Input Voltage, High	IXDD614 only	V_{ENH}	$2/3V_{CC}$	-	-	V
EN Input Voltage, Low	IXDD614 only	V_{ENL}	-	-	$1/3V_{CC}$	
Output Voltage, High	-	V_{OH}	$V_{CC}-0.025$	-	-	V
Output Voltage, Low	-	V_{OL}	-	-	0.025	
Output Resistance, High State	$V_{CC}=18\text{V}, I_{OUT}=-100\text{mA}$	R_{OH}	-	0.4	0.8	Ω
Output Resistance, Low State	$V_{CC}=18\text{V}, I_{OUT}=100\text{mA}$	R_{OL}	-	0.3	0.6	
Output Current, Continuous	Limited by package power dissipation	I_{DC}	-	-	± 4	A
Rise Time	$C_{LOAD}=15\text{nF}, V_{CC}=18\text{V}$	t_R	-	25	35	ns
Fall Time	$C_{LOAD}=15\text{nF}, V_{CC}=18\text{V}$	t_F	-	18	25	
On-Time Propagation Delay	$C_{LOAD}=15\text{nF}, V_{CC}=18\text{V}$	$t_{ONDELAY}$	-	50	70	
Off-Time Propagation Delay	$C_{LOAD}=15\text{nF}, V_{CC}=18\text{V}$	$t_{OFFDELAY}$	-	50	70	
Enable to Output-High Delay Time	IXDD614 only	t_{ENOH}	-	31	60	
Disable to High Impedance State Delay Time	IXDD614 only	t_{DOLD}	-	44	70	
Enable Pull-Up Resistor	IXDD614 only	R_{EN}	-	200	-	$\text{k}\Omega$
Power Supply Current	$V_{CC}=18\text{V}, V_{IN}=3.5\text{V}$	I_{CC}	-	1	2	mA
	$V_{CC}=18\text{V}, V_{IN}=0\text{V}$		-	<1	10	μA
	$V_{CC}=18\text{V}, V_{IN}=V_{CC}$		-	<1	10	

1.6 Electrical Characteristics: $T_A = -40^{\circ}\text{C}$ to $+125^{\circ}\text{C}$

Test Conditions: $4.5\text{V} \leq V_{CC} \leq 35\text{V}$.

Parameter	Conditions	Symbol	Minimum	Maximum	Units
Input Voltage, High	$4.5\text{V} \leq V_{CC} \leq 18\text{V}$	V_{IH}	3.3	-	V
Input Voltage, Low	$4.5\text{V} \leq V_{CC} \leq 18\text{V}$	V_{IL}	-	0.65	
Input Current	$0\text{V} \leq V_{IN} \leq V_{CC}$	I_{IN}	-	± 10	μA
Output Voltage, High	-	V_{OH}	$V_{CC}-0.025$	-	V
Output Voltage, Low	-	V_{OL}	-	0.025	
Output Resistance, High State	$V_{CC}=18\text{V}, I_{OUT}=-100\text{mA}$	R_{OH}	-	1.5	Ω
Output Resistance, Low State	$V_{CC}=18\text{V}, I_{OUT}=100\text{mA}$	R_{OL}	-	1.2	
Output Current, Continuous	Limited by package power dissipation	I_{DC}	-	± 1	A
Rise Time	$C_{LOAD}=15\text{nF}, V_{CC}=18\text{V}$	t_R	-	50	ns
Fall Time	$C_{LOAD}=15\text{nF}, V_{CC}=18\text{V}$	t_F	-	40	
On-Time Propagation Delay	$C_{LOAD}=15\text{nF}, V_{CC}=18\text{V}$	$t_{ONDELAY}$	-	90	
Off-Time Propagation Delay	$C_{LOAD}=15\text{nF}, V_{CC}=18\text{V}$	$t_{OFFDELAY}$	-	90	
Enable to Output-High Delay Time	IXDD614 only	t_{ENOH}	-	75	
Disable to High Impedance State Delay Time	IXDD614 only	t_{DOLD}	-	85	
Power Supply Current	$V_{CC}=18\text{V}, V_{IN}=3.5\text{V}$	I_{CC}	-	3	mA
	$V_{CC}=18\text{V}, V_{IN}=0\text{V}$		-	150	μA
	$V_{CC}=18\text{V}, V_{IN}=V_{CC}$		-	150	

1.7 Thermal Characteristics

Package	Parameter	Symbol	Rating	Units
CI (5-Pin TO-220)	Thermal Resistance, Junction-to-Ambient	θ_{JA}	36	°C/W
PI (8-Pin DIP)			125	
SI (8-Pin Power SOIC)			85	
YI (5-Pin TO-263)			46	
CI (5-Pin TO-220)	Thermal Resistance, Junction-to-Case	θ_{JC}	3	°C/W
SI (8-Pin Power SOIC)			10	
YI (5-Pin TO-263)			2	

2 Performance

2.1 Timing Diagrams

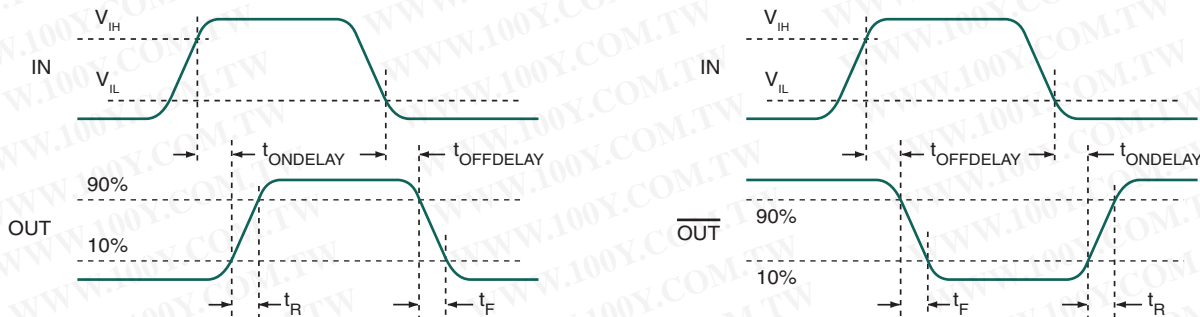

2.2 Characteristics Test Diagram

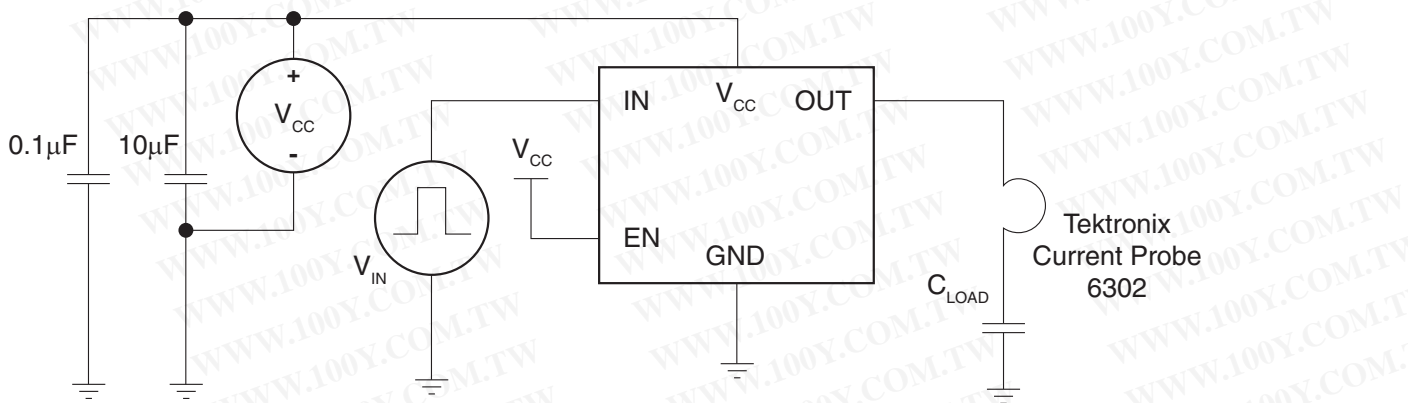

4 Typical Performance Characteristics

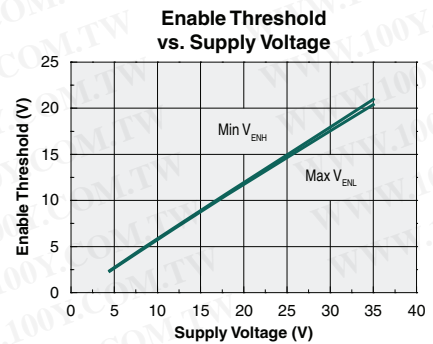
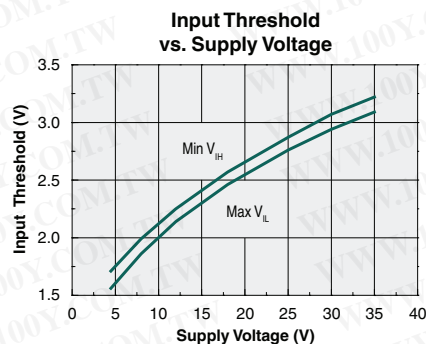
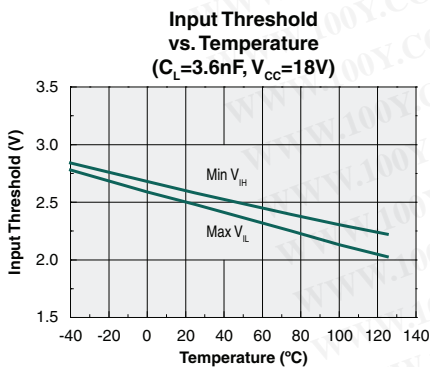
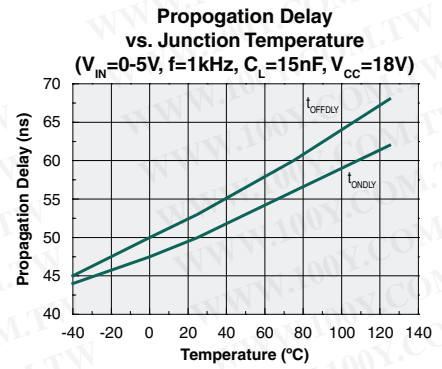
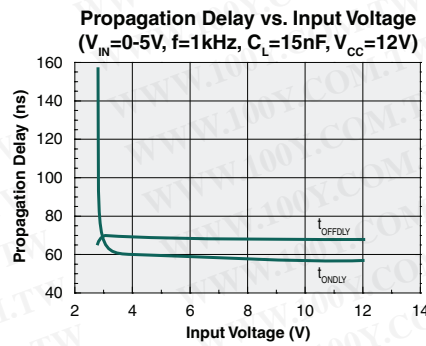
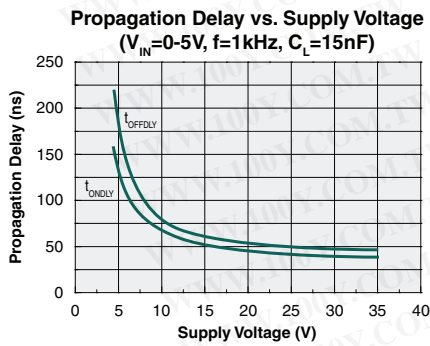
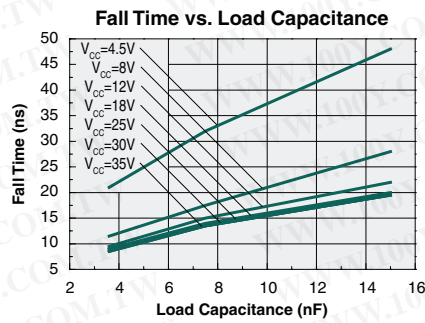
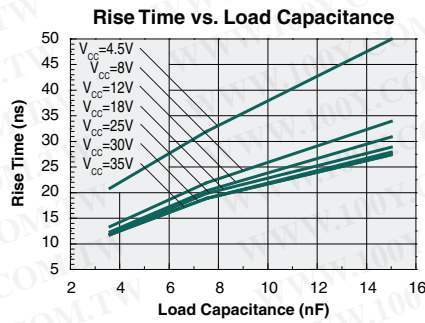
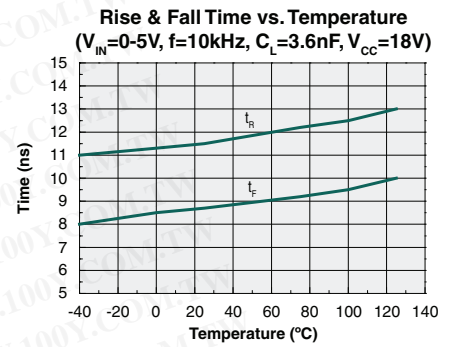
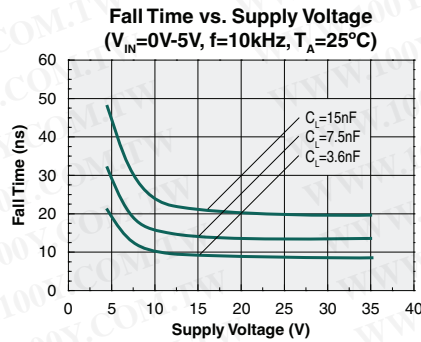
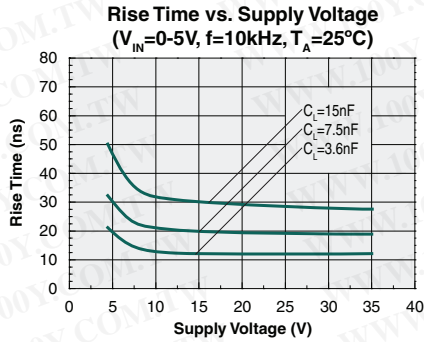

Supply Current vs. Load Capacitance
($V_{CC}=35V$)

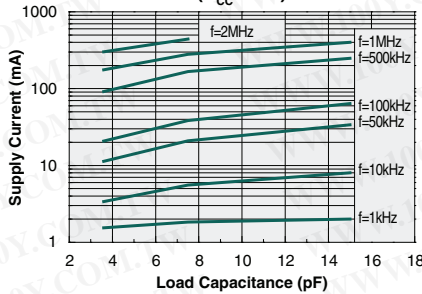

Supply Current vs. Load Capacitance
($V_{CC}=18V$)

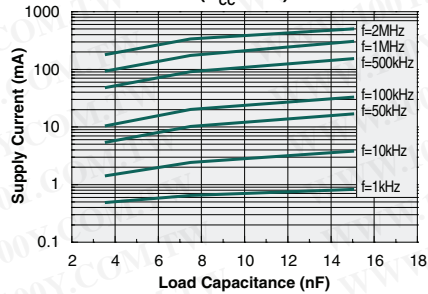

Supply Current vs. Load Capacitance
($V_{CC}=12V$)

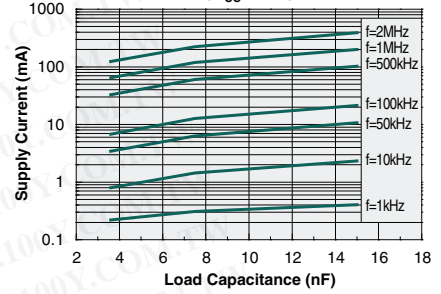

Supply Current vs. Load Capacitance
($V_{CC}=8V$)

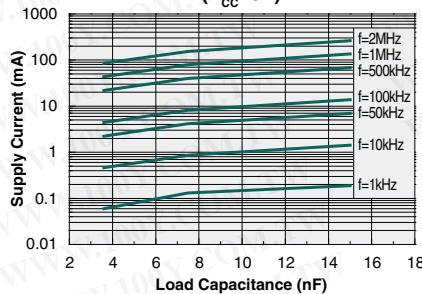

Supply Current vs. Frequency
($V_{CC}=35V$)

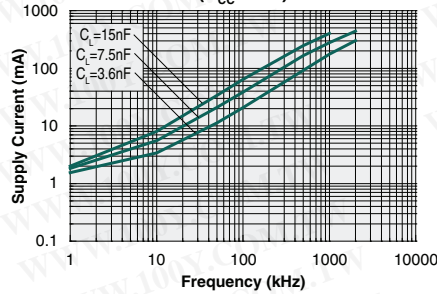

Supply Current vs. Frequency
($V_{CC}=18V$)

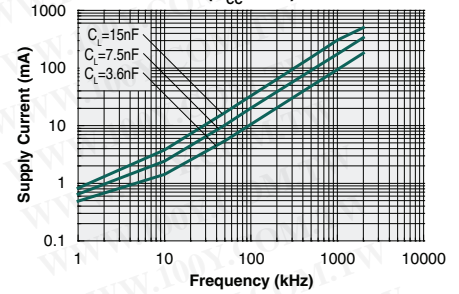

Supply Current vs. Frequency
($V_{CC}=12V$)

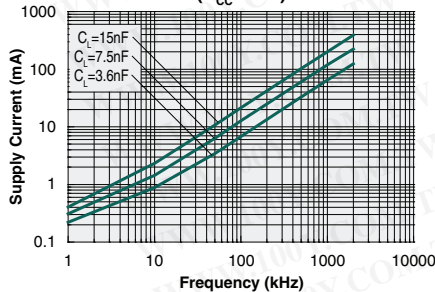

Supply Current vs. Frequency
($V_{CC}=8V$)

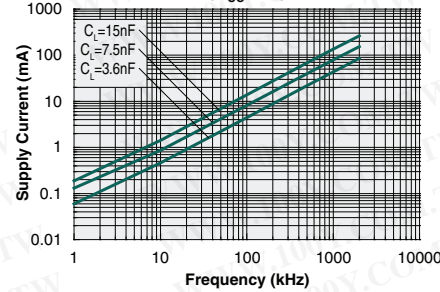

Quiescent Supply Current
vs. Temperature

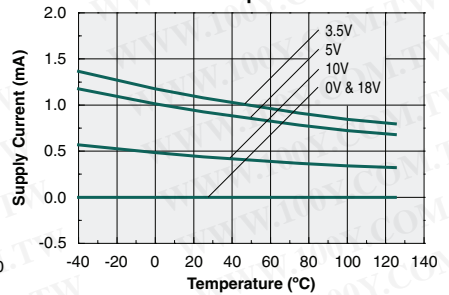

Dynamic Supply Current
vs. Temperature
($V_{IN}=0-5V, f=1kHz, C_L=5.4nF, V_{CC}=18V$)

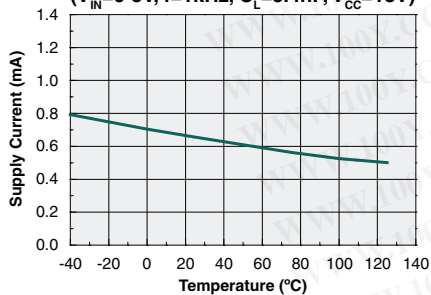

Output Source Current
vs. Supply Voltage
($C_L=330nF$)

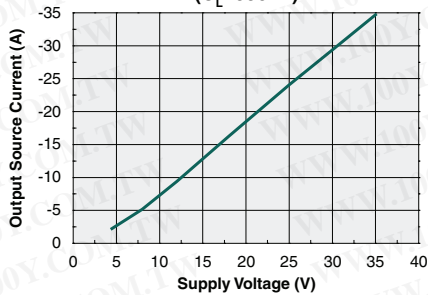

Output Sink Current
vs. Supply Voltage
($C_L=330nF$)

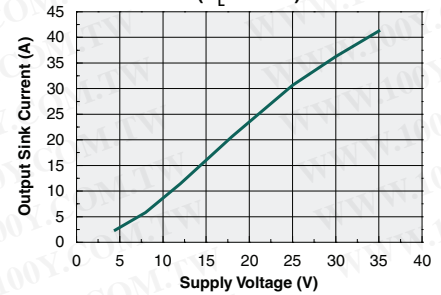

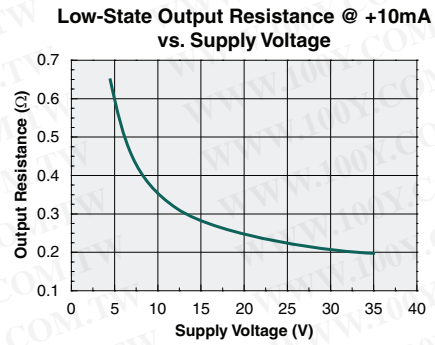
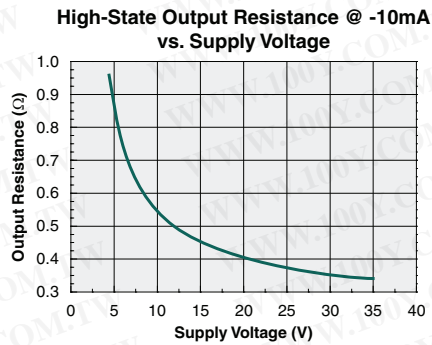
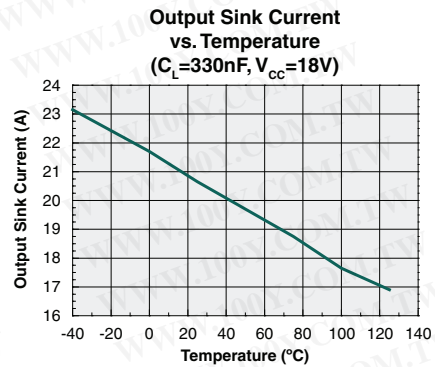
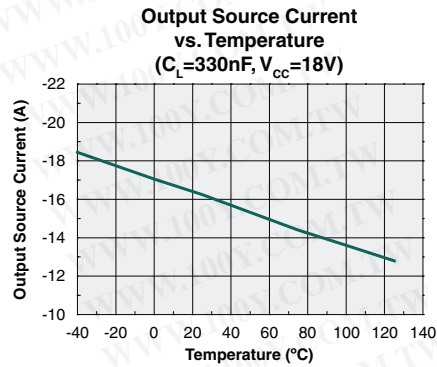

5 Manufacturing Information

5.1 Moisture Sensitivity



All plastic encapsulated semiconductor packages are susceptible to moisture ingress. IXYS Integrated Circuits Division classified all of its plastic encapsulated devices for moisture sensitivity according to the latest version of the joint industry standard, **IPC/JEDEC J-STD-020**, in force at the time of product evaluation. We test all of our products to the maximum conditions set forth in the standard, and guarantee proper operation of our devices when handled according to the limitations and information in that standard as well as to any limitations set forth in the information or standards referenced below.

Failure to adhere to the warnings or limitations as established by the listed specifications could result in reduced product performance, reduction of operable life, and/or reduction of overall reliability.

This product carries a **Moisture Sensitivity Level (MSL) rating** as shown below, and should be handled according to the requirements of the latest version of the joint industry standard **IPC/JEDEC J-STD-033**.

Device	Moisture Sensitivity Level (MSL) Rating
IXD_614SI / IXD_614PI / IXD_614CI / IXD_614YI	MSL 1

5.2 ESD Sensitivity



This product is **ESD Sensitive**, and should be handled according to the industry standard **JESD-625**.

5.3 Reflow Profile

This product has a maximum body temperature and time rating as shown below. All other guidelines of **J-STD-020** must be observed.

Device	Maximum Temperature x Time
IXD_614CI / IXD_614YI	245°C for 30 seconds
IXD_614PI	250°C for 30 seconds
IXD_614SI	260°C for 30 seconds



5.4.3 YI (5-Pin TO-263)

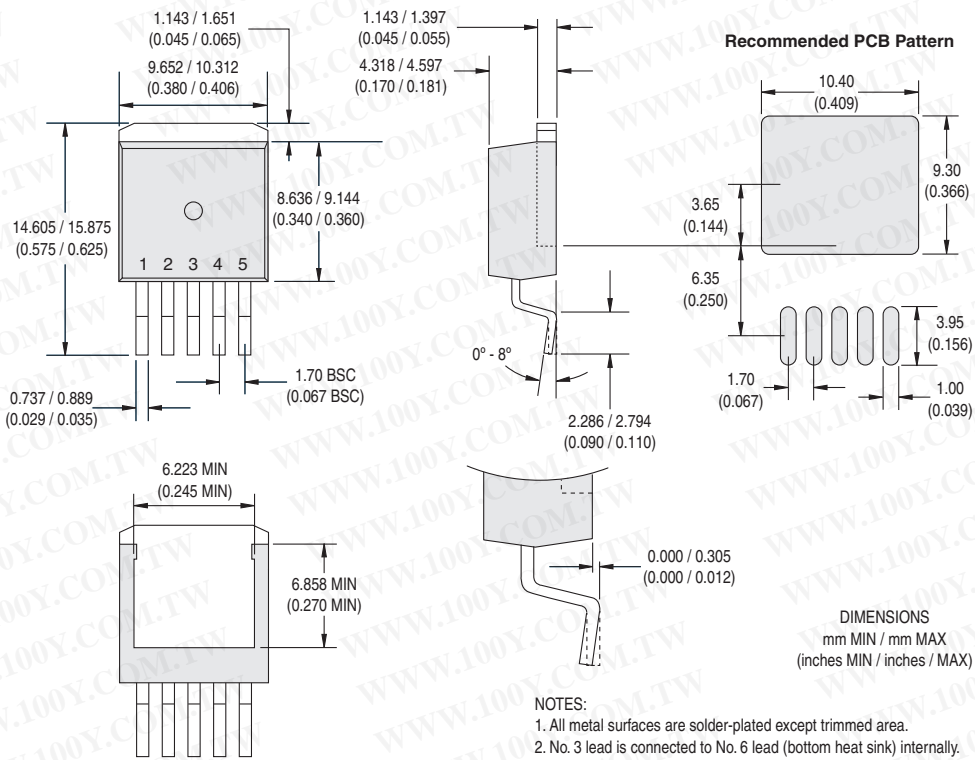

5.4.4 CI (5-Pin TO-220)

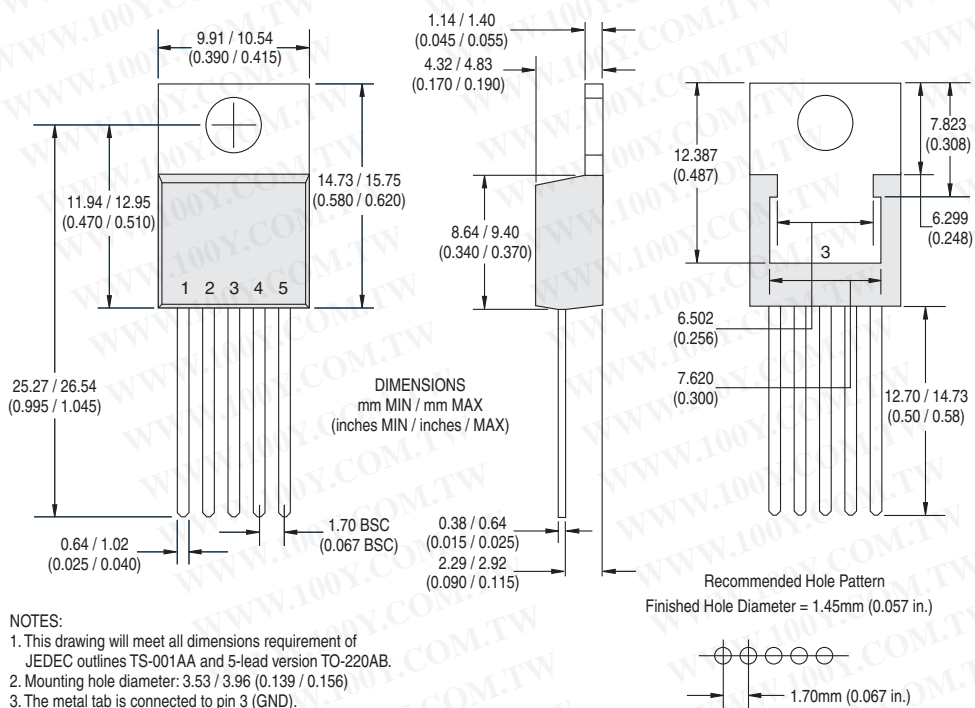

5.4.5 PI (8-Pin DIP)

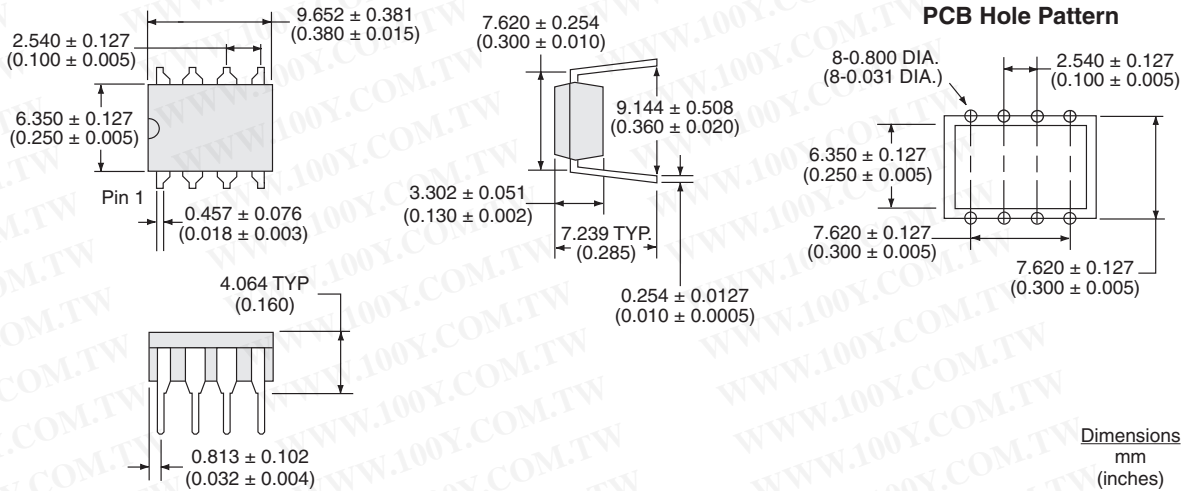

勝特力材料 886-3-5753170
 勝特力电子(上海) 86-21-34970699
 勝特力电子(深圳) 86-755-83298787
[Http://www.100y.com.tw](http://www.100y.com.tw)

For additional information please visit our website at: www.ixysic.com

IXYS Integrated Circuits Division makes no representations or warranties with respect to the accuracy or completeness of the contents of this publication and reserves the right to make changes to specifications and product descriptions at any time without notice. Neither circuit patent licenses nor indemnity are expressed or implied. Except as set forth in IXYS Integrated Circuits Division's Standard Terms and Conditions of Sale, IXYS Integrated Circuits Division assumes no liability whatsoever, and disclaims any express or implied warranty, relating to its products including, but not limited to, the implied warranty of merchantability, fitness for a particular purpose, or infringement of any intellectual property right.

The products described in this document are not designed, intended, authorized or warranted for use as components in systems intended for surgical implant into the body, or in other applications intended to support or sustain life, or where malfunction of IXYS Integrated Circuits Division's product may result in direct physical harm, injury, or death to a person or severe property or environmental damage. IXYS Integrated Circuits Division reserves the right to discontinue or make changes to its products at any time without notice.

Specification: DS-IXD_614-R05
 ©Copyright 2012, IXYS Integrated Circuits Division
 All rights reserved. Printed in USA.
 11/8/2012