

IR2213(S) & (PbF)

International
IR Rectifier

Absolute Maximum Ratings

Absolute Maximum Ratings indicate sustained limits beyond which damage to the device may occur. All voltage parameters are absolute voltages referenced to COM. The Thermal Resistance and Power Dissipation ratings are measured under board mounted and still air conditions.

Symbol	Definition	Min.	Max.	Units	
V _B	High Side Floating Supply Voltage	-0.3	1225		
V _S	High Side Floating Supply Offset Voltage	V _B - 25	V _B + 0.3	V	
V _{HO}	High Side Floating Output Voltage	V _S - 0.3	V _B + 0.3		
V _{CC}	Low Side Fixed Supply Voltage	-0.3	25		
V _{LO}	Low Side Output Voltage	-0.3	V _{CC} + 0.3		
V _{DD}	Logic Supply Voltage	-0.3	V _{SS} + 25		
V _{SS}	Logic Supply Offset Voltage	V _{CC} - 25	V _{CC} + 0.3		
V _{IN}	Logic Input Voltage (HIN, LIN & SD)	V _{SS} - 0.3	V _{DD} + 0.3		
dV _S /dt	Allowable Offset Supply Voltage Transient (Figure 2)	—	50		V/ns
P _D	Package Power Dissipation @ T _A ≤ +25°C	(14 Lead PDIP)	—	1.6	W
		(16 Lead SOIC)	—	1.25	
R _{THJA}	Thermal Resistance, Junction to Ambient	(14 Lead PDIP)	—	75	°C/W
		(16 Lead SOIC)	—	100	
T _J	Junction Temperature	—	125	°C	
T _S	Storage Temperature	-55	150		
T _L	Lead Temperature (Soldering, 10 seconds)	—	300		

Recommended Operating Conditions

The Input/Output logic timing diagram is shown in Figure 1. For proper operation the device should be used within the recommended conditions. The V_S and V_{SS} offset ratings are tested with all supplies biased at 15V differential.

Symbol	Definition	Min.	Max.	Units
V _B	High Side Floating Supply Absolute Voltage	V _S + 12	V _S + 20	V
V _S	High Side Floating Supply Offset Voltage	Note 1	1200	
V _{HO}	High Side Floating Output Voltage	V _S	V _B	
V _{CC}	Low Side Fixed Supply Voltage	12	20	
V _{LO}	Low Side Output Voltage	0	V _{CC}	
V _{DD}	Logic Supply Voltage	V _{SS} + 3	V _{SS} + 20	
V _{SS}	Logic Supply Offset Voltage	-5 (Note 2)	5	
V _{IN}	Logic Input Voltage (HIN, LIN & SD)	V _{SS}	V _{DD}	

Note 1: Logic operational for V_S of -5 to +1200V. Logic state held for V_S of -5V to -V_{BS}. (Please refer to the Design Tip DT97-3 for more details).

Note 2: When V_{DD}<5V, the minimum V_{SS} offset is limited to -V_{DD}

IR2213(s) & (PbF)

Dynamic Electrical Characteristics

V_{BIAS} (V_{CC} , V_{BS} , V_{DD}) = 15V, C_L = 1000 pF, T_A = 25°C and V_{SS} = COM unless otherwise specified. The dynamic electrical characteristics are measured using the test circuit shown in Figure 3.

Symbol	Definition	Min.	Typ.	Max.	Units	Test Conditions
t_{on}	Turn-On Propagation Delay	—	280	—	ns	$V_S = 0V$
t_{off}	Turn-Off Propagation Delay	—	225	—		$V_S = 1200V$
t_{sd}	Shutdown Propagation Delay	—	230	—		$V_S = 1200V$
t_r	Turn-On Rise Time	—	25	—		
t_f	Turn-Off Fall Time	—	17	—		
MT	Delay Matching, HS & LS Turn-On/Off	—	—	30		

Static Electrical Characteristics

V_{BIAS} (V_{CC} , V_{BS} , V_{DD}) = 15V, T_A = 25°C and V_{SS} = COM unless otherwise specified. The V_{IH} , V_{TH} and I_{IN} parameters are referenced to V_{SS} and are applicable to all three logic input leads: HIN, LIN and SD. The V_O and I_O parameters are referenced to COM and are applicable to the respective output leads: HO or LO.

Symbol	Definition	Min.	Typ.	Max.	Units	Test Conditions
V_{IH}	Logic "1" Input Voltage	9.5	—	—	V	
V_{IL}	Logic "0" Input Voltage	—	—	6.0		
V_{OH}	High Level Output Voltage, $V_{BIAS} - V_O$	—	—	1.2		$I_O = 0A$
V_{OL}	Low Level Output Voltage, V_O	—	—	0.1		$I_O = 0A$
I_{LK}	Offset Supply Leakage Current	—	—	50	μA	$V_B = V_S = 1200V$
I_{QBS}	Quiescent V_{BS} Supply Current	—	125	230		$V_{IN} = 0V$ or V_{DD}
I_{QCC}	Quiescent V_{CC} Supply Current	—	180	340		$V_{IN} = 0V$ or V_{DD}
I_{QDD}	Quiescent V_{DD} Supply Current	—	15	30		$V_{IN} = 0V$ or V_{DD}
I_{IN+}	Logic "1" Input Bias Current	—	20	40		$V_{IN} = V_{DD}$
I_{IN-}	Logic "0" Input Bias Current	—	—	1.0		$V_{IN} = 0V$
V_{BSUV+}	V_{BS} Supply Undervoltage Positive Going Threshold	8.7	10.2	11.7	V	
V_{BSUV-}	V_{BS} Supply Undervoltage Negative Going Threshold	7.9	9.3	10.7		
V_{CCUV+}	V_{CC} Supply Undervoltage Positive Going Threshold	8.7	10.2	11.7		
V_{CCUV-}	V_{CC} Supply Undervoltage Negative Going Threshold	7.9	9.3	10.7		
I_{O+}	Output High Short Circuit Pulsed Current	1.7	2.0	—	A	$V_O = 0V, V_{IN} = V_{DD}$ $PW \leq 10 \mu s$
I_{O-}	Output Low Short Circuit Pulsed Current	2.0	2.5	—		$V_O = 15V, V_{IN} = 0V$ $PW \leq 10 \mu s$

IR2213(S) & (PbF)

International
IR Rectifier

Functional Block Diagram

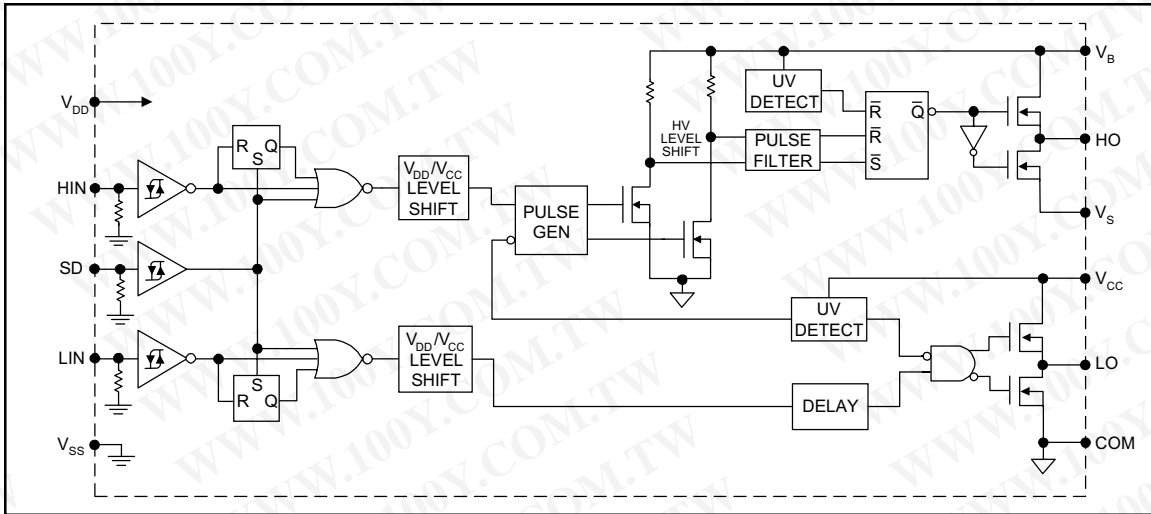

Lead Definitions

Symbol	Description
VDD	Logic supply
HIN	Logic input for high side gate driver output (HO), in phase
SD	Logic input for shutdown
LIN	Logic input for low side gate driver output (LO), in phase
VSS	Logic ground
VB	High side floating supply
HO	High side gate drive output
VS	High side floating supply return
VCC	Low side supply
LO	Low side gate drive output
COM	Low side return

Lead Assignments

<p>14 Lead PDIP</p>	<p>16 Lead SOIC (Wide Body)</p>
IR2213	IR2213S
Part Number	

International
IGR Rectifier

IR2213(s) & (PbF)

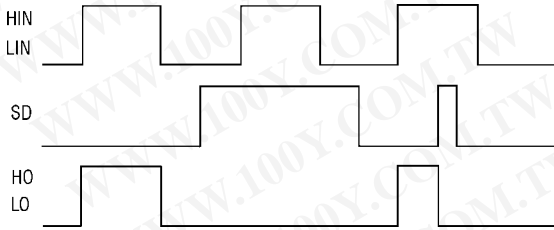

Figure 1. Input/Output Timing Diagram

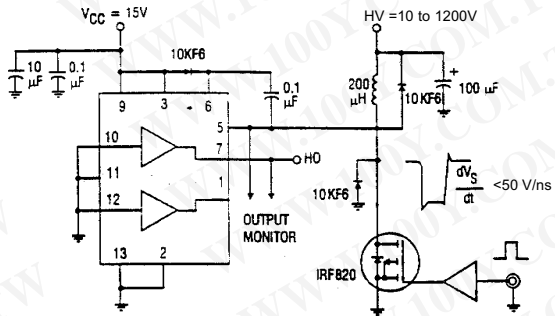

Figure 2. Floating Supply Voltage Transient Test Circuit

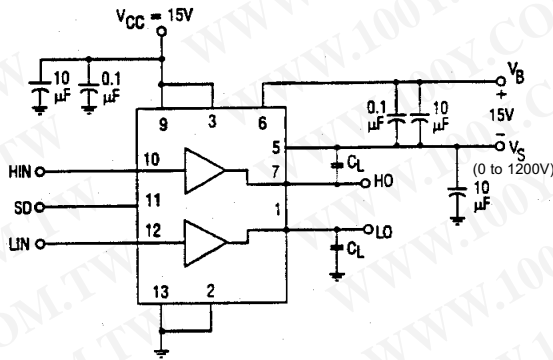

Figure 3. Switching Time Test Circuit

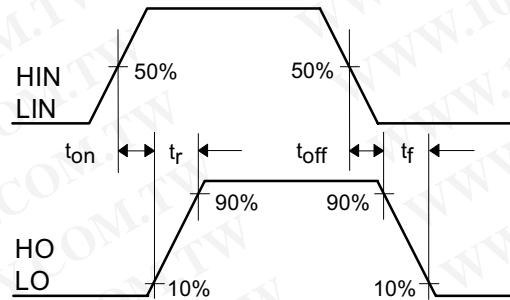

Figure 4. Switching Time Waveform Definition

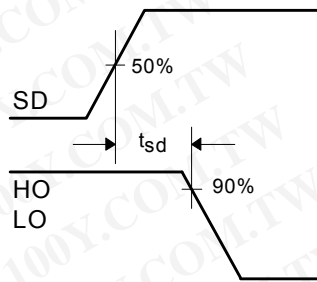

Figure 5. Shutdown Waveform Definitions

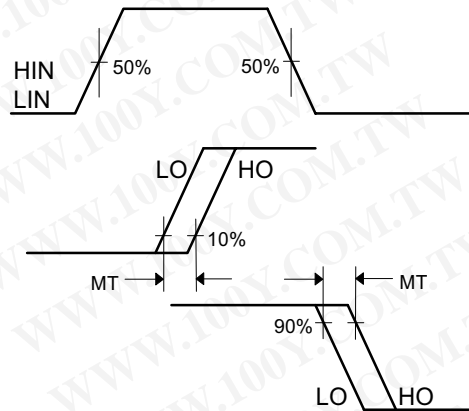

Figure 6. Delay Matching Waveform Definitions

IR2213(S) & (PbF)

International
IR Rectifier

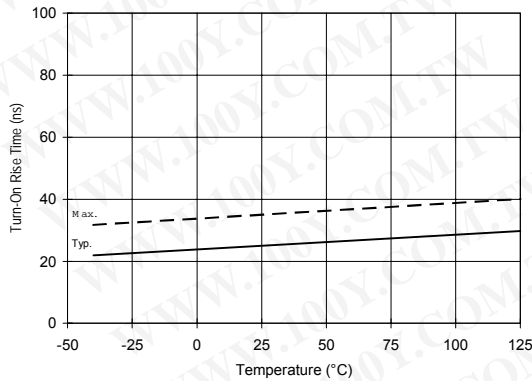

Figure 10A. Turn-On Rise Time vs. Temperature

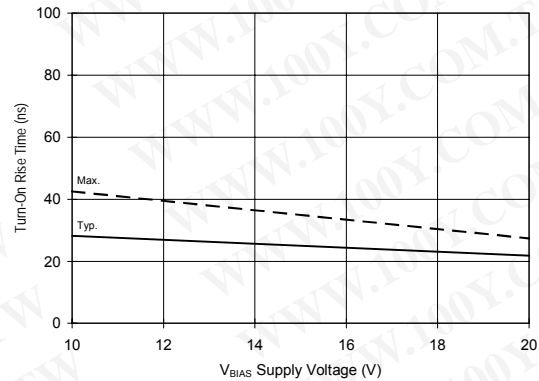

Figure 10B. Turn-On Rise Time vs. Voltage

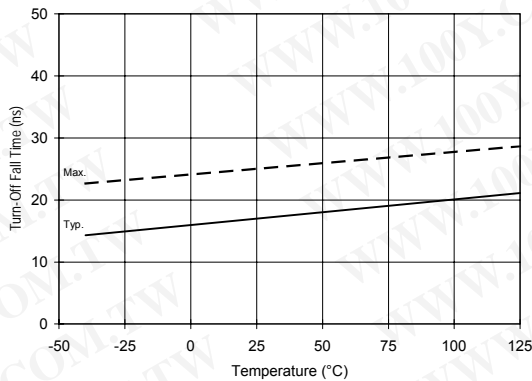

Figure 11A. Turn-Off Fall Time vs. Temperature

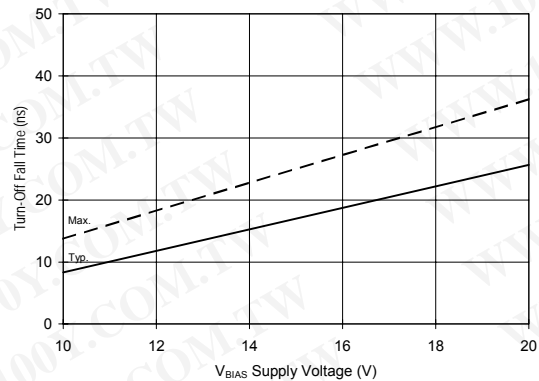

Figure 11B. Turn-Off Fall Time vs. Voltage

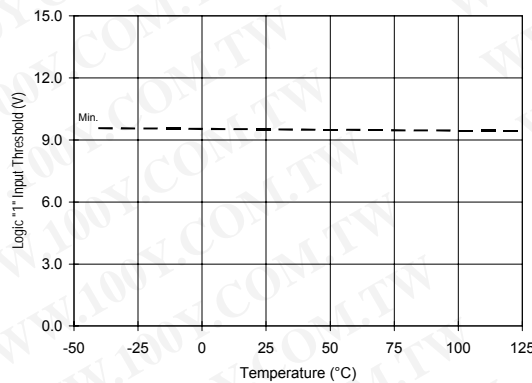

Figure 12A. Logic "1" Input Threshold vs. Temperature

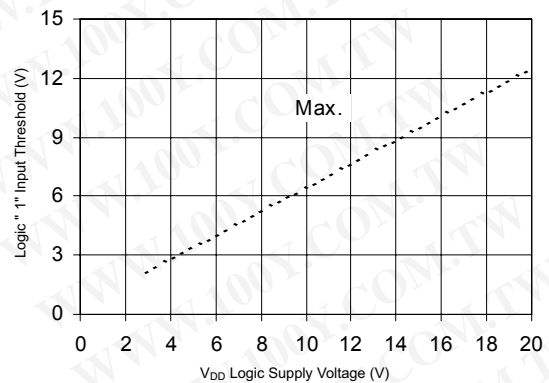

Figure 12B. Logic "1" Input Threshold vs. Voltage

International
IR Rectifier

IR2213(s) & (PbF)

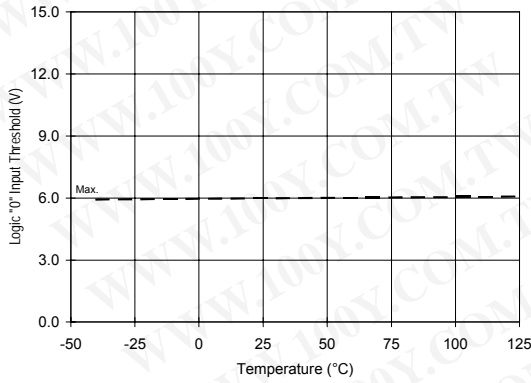

Figure 13A. Logic "0" Input Threshold vs. Temperature

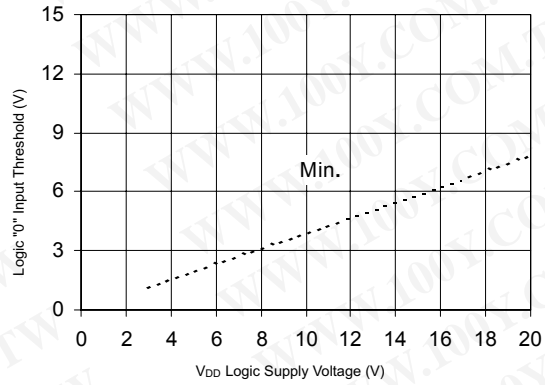

Figure 13B. Logic "0" Input Threshold vs. Voltage

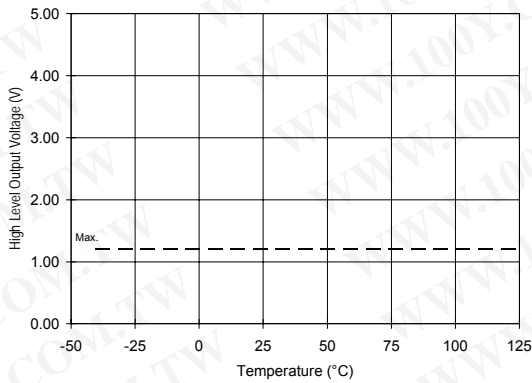

Figure 14A. High Level Output vs. Temperature

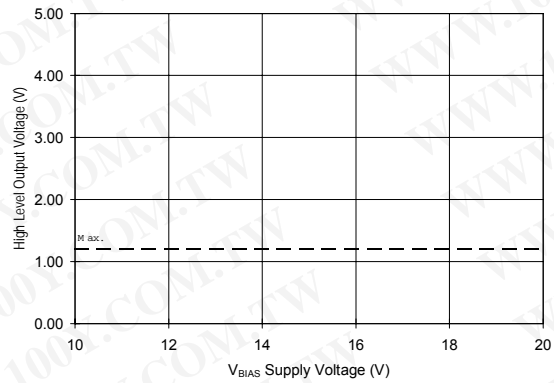

Figure 14B. High Level Output vs. Voltage

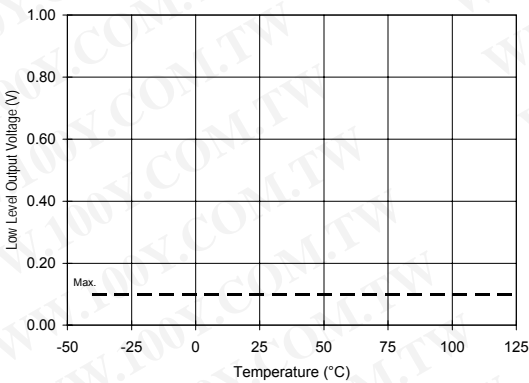

Figure 15A. Low Level Output vs. Temperature

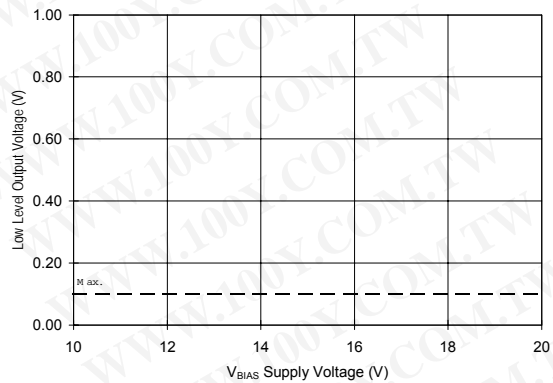

Figure 15B. Low Level Output vs. Voltage

IR2213(S) & (PbF)

International
IR Rectifier

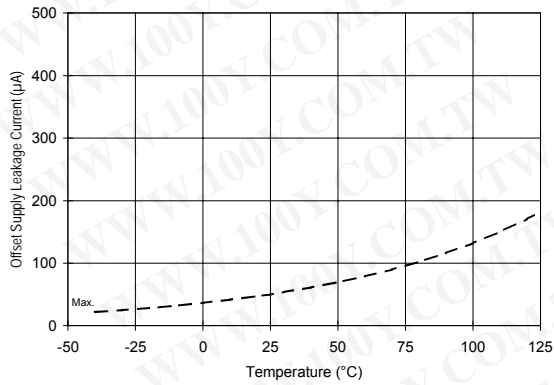

Figure 16A. Offset Supply Current vs. Temperature

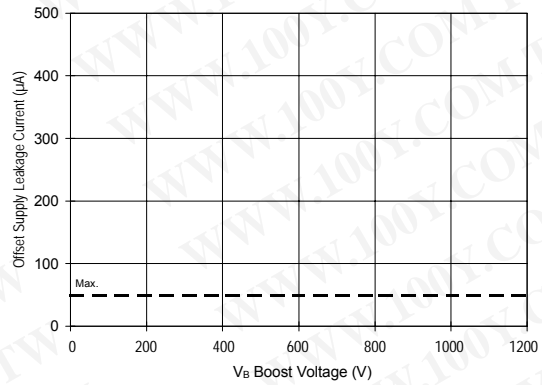

Figure 16B. Offset Supply Current vs. Voltage

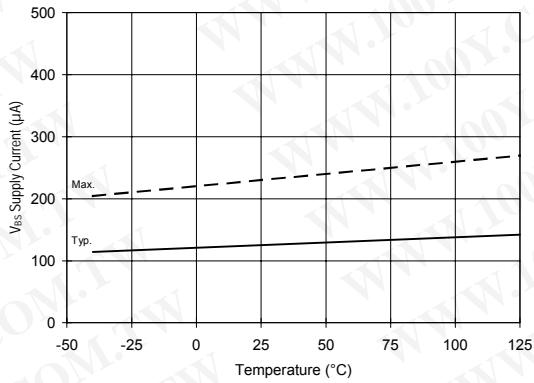

Figure 17A. V_{BS} Supply Current vs. Temperature

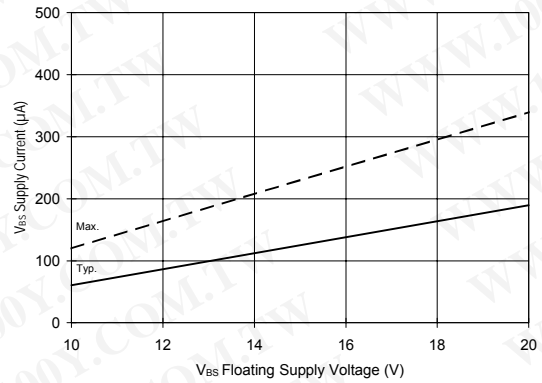

Figure 17B. V_{BS} Supply Current vs. Voltage

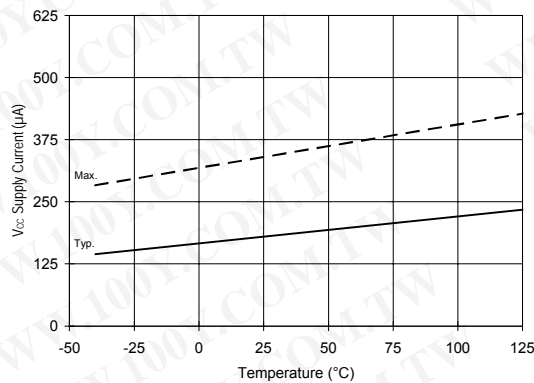

Figure 18A. V_{CC} Supply Current vs. Temperature

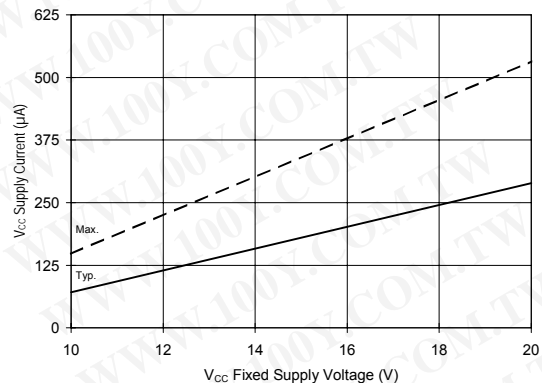

Figure 18B. V_{CC} Supply Current vs. Voltage

International
IR Rectifier

IR2213(s) & (PbF)

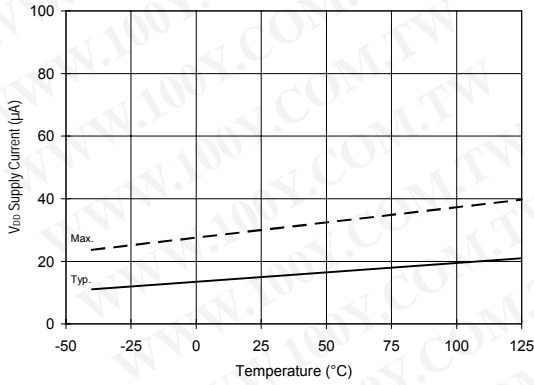

Figure 19A. V_{DD} Supply Current vs. Temperature

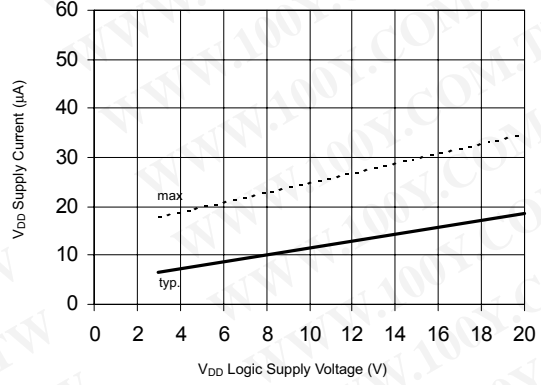

Figure 19B. V_{DD} Supply Current vs. V_{DD} Voltage

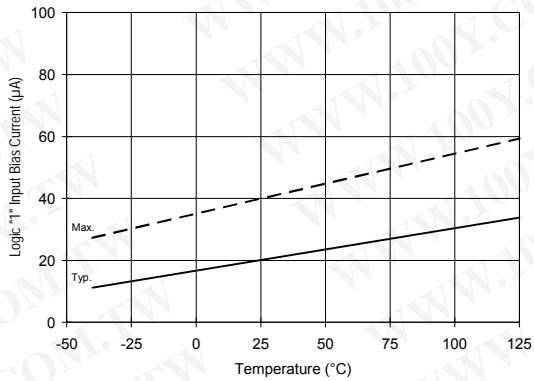

Figure 20A. Logic "1" Input Current vs. Temperature

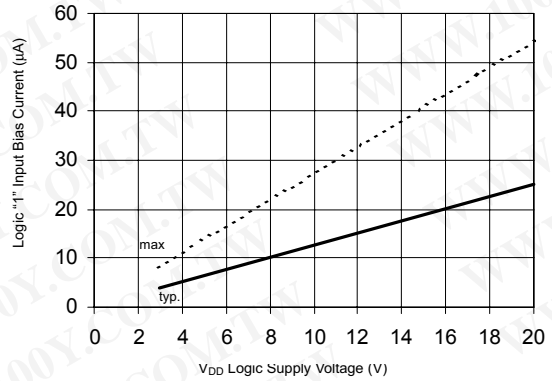

Figure 20B. Logic "1" Input Current vs. V_{DD} Voltage

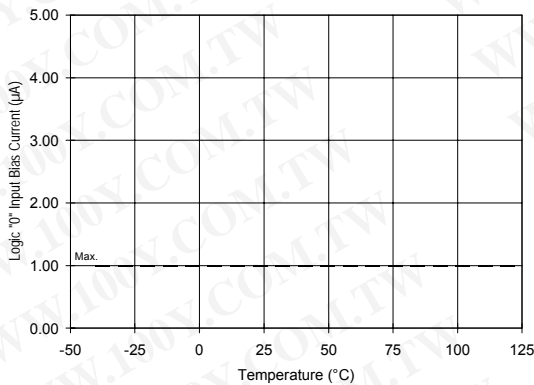

Figure 21A. Logic "0" Input Current vs. Temperature

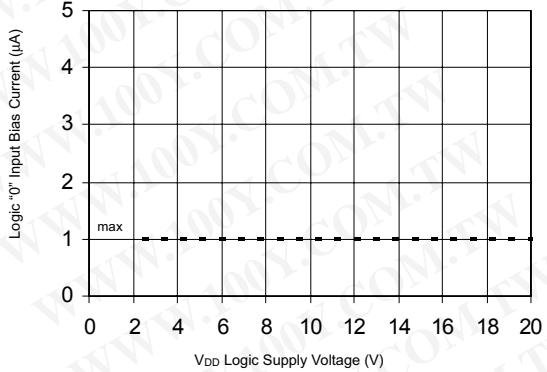

Figure 21B. Logic "0" Input Current vs. V_{DD} Voltage

IR2213(S) & (PbF)

International
IR Rectifier

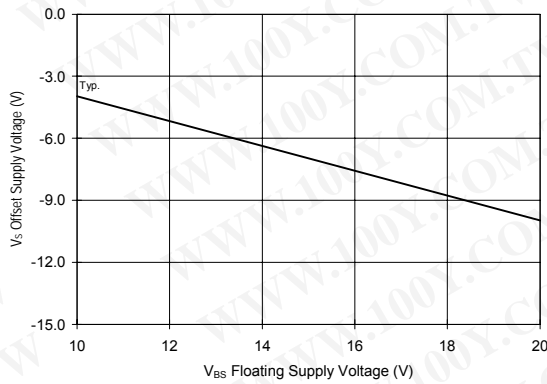

Figure 22. Maximum V_s Negative Offset vs. V_{as} Supply Voltage

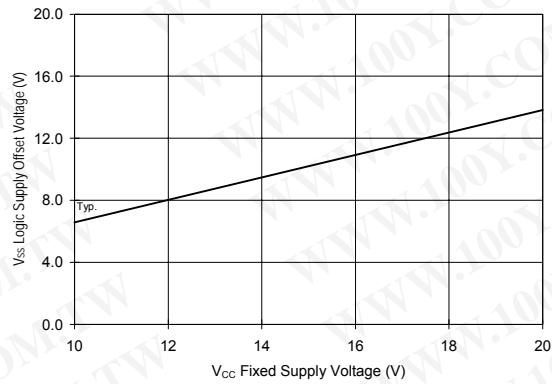

Figure 23. Maximum V_{ss} Positive Offset vs. V_{cc} Supply Voltage

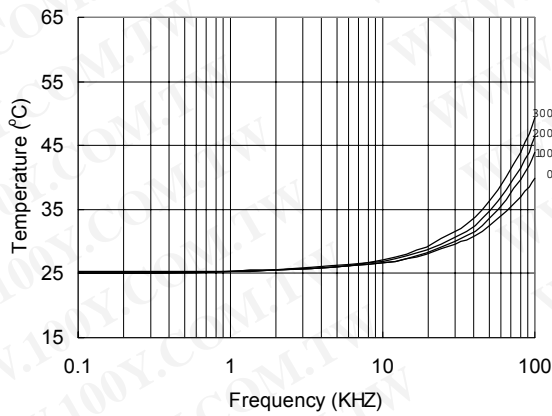

Figure 24. IR2213s vs. Frequency (IRFBC20)
 $R_{gate}=33\Omega, V_{cc}=15V$

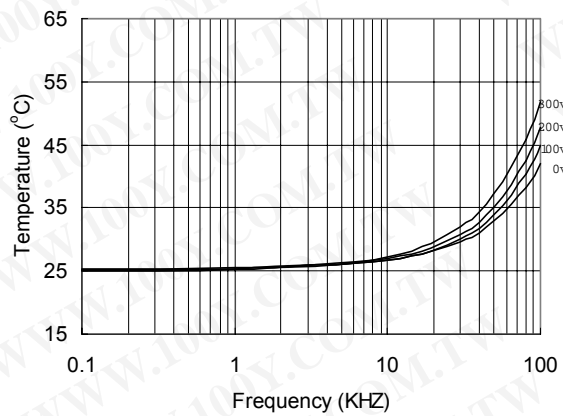

Figure 25. IR2213s vs. Frequency (IRFBC30)
 $R_{gate}=22\Omega, V_{cc}=15V$

International
IGR Rectifier

IR2213(s) & (PbF)

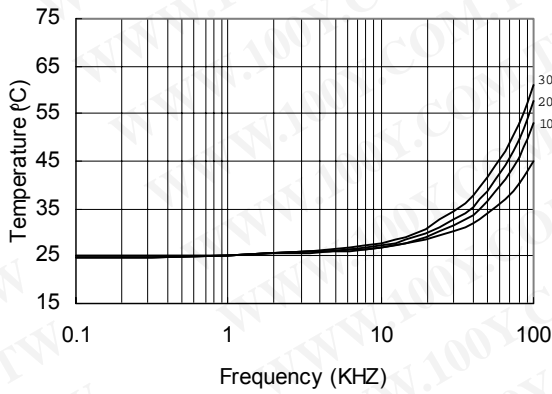

Figure 26. IR2213s vs. Frequency (IRFBC40)
 $R_{gate}=15\Omega, V_{CC}=15V$

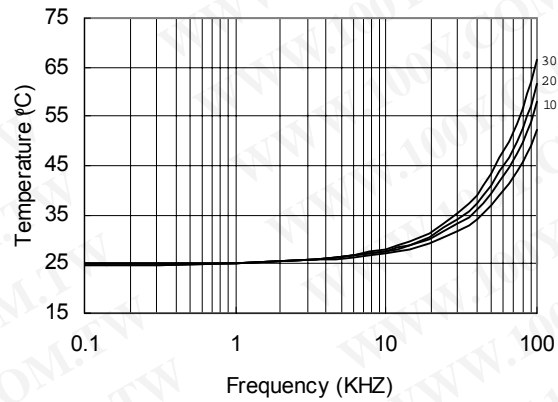

Figure 27. IR2213s vs. Frequency (IRFBC50)
 $R_{gate}=10\Omega, V_{CC}=15V$

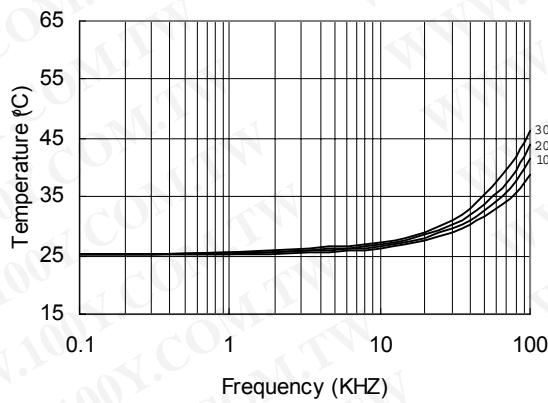

Figure 28. IR2213 vs. Frequency (IRFBC20)
 $R_{gate}=33\Omega, V_{CC}=15V$

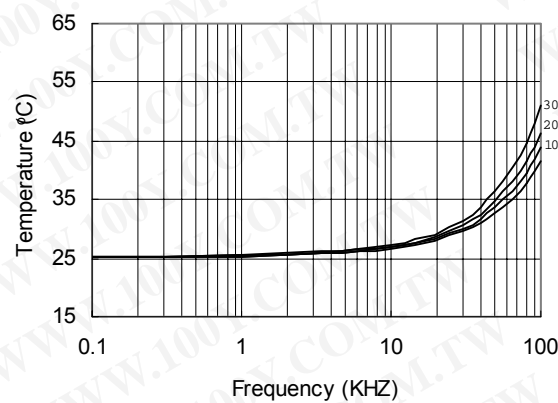

Figure 29. IR2213 vs. Frequency (IRFBC30)
 $R_{gate}=22\Omega, V_{CC}=15V$

IR2213(S) & (PbF)

International
IR Rectifier

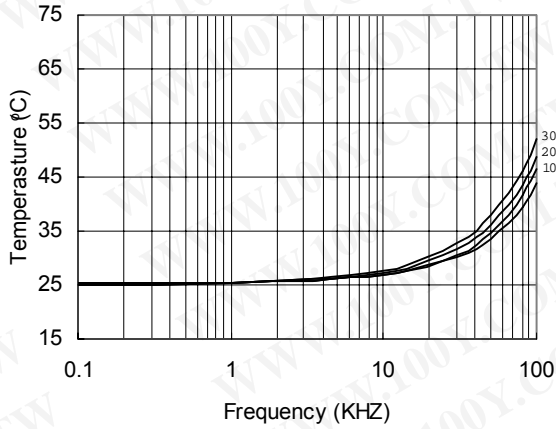

Figure 30. IR2213 vs. Frequency (IRFBC40)
 $R_{gate}=15\Omega$, $V_{CC}=15V$

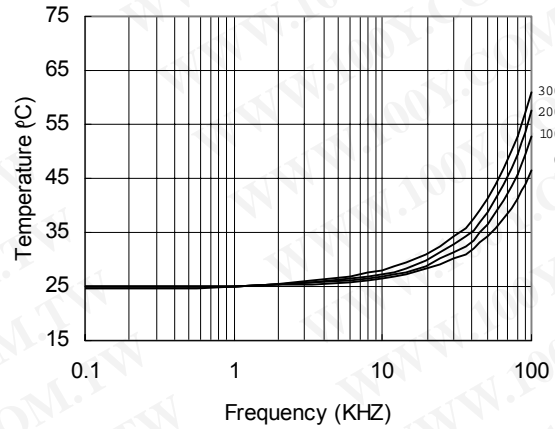
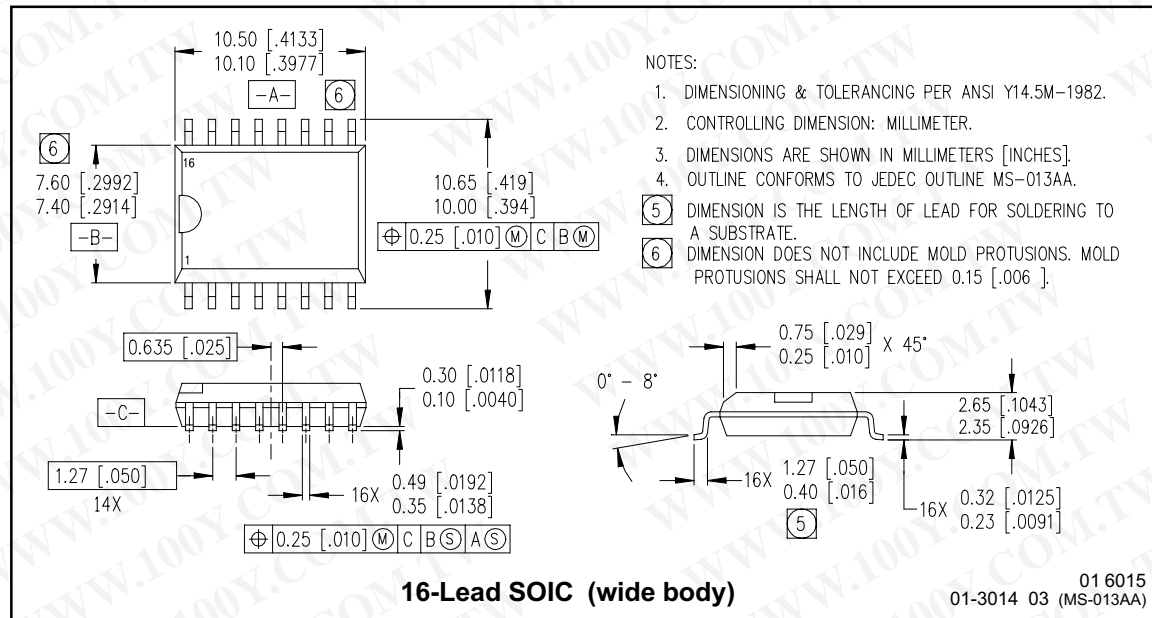
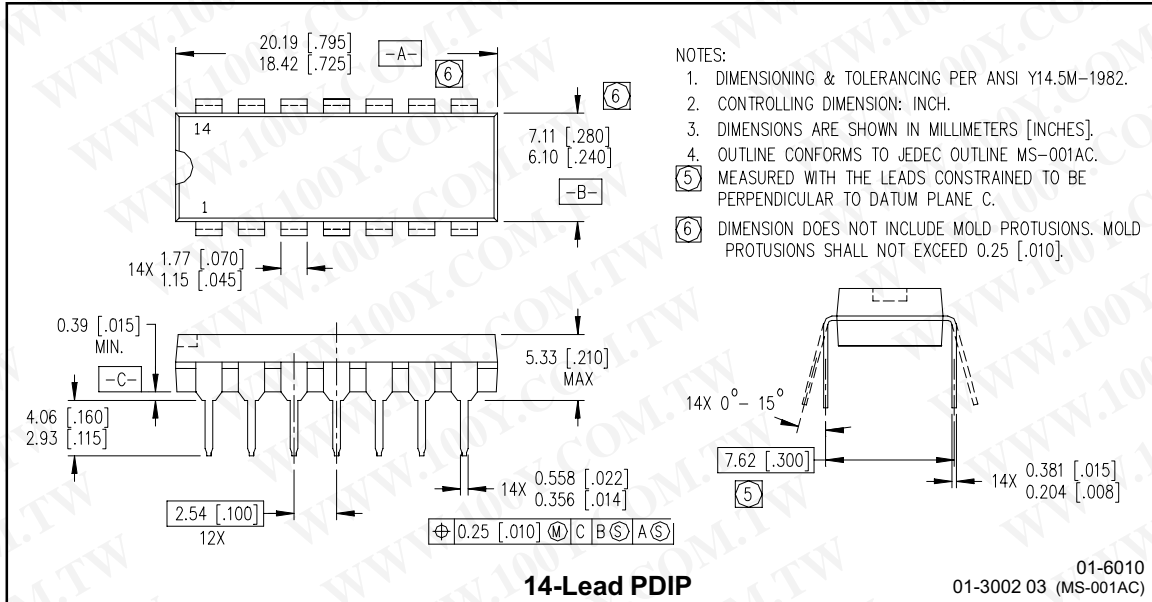

Figure 31. IR213 vs. Frequency (IRFBC50)
 $R_{gate}=10\Omega$, $V_{CC}=15V$

IR2213(s) & (PbF)

Case outlines



IR2213(S) & (PbF)

International
IR Rectifier

Tape & Reel 16-Lead SOIC

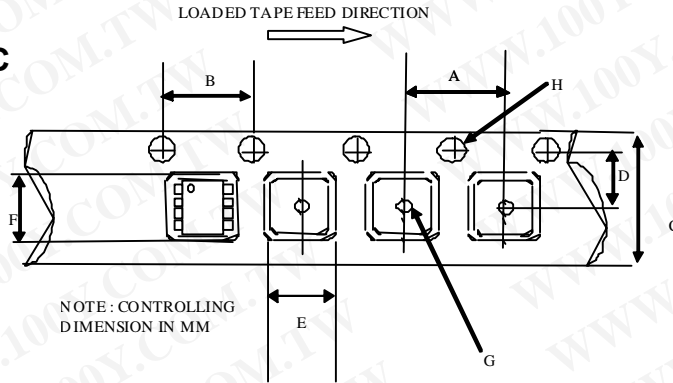

CARRIER TAPE DIMENSION FOR 16SOICW

Code	Metric		Imperial	
	Min	Max	Min	Max
A	11.90	12.10	0.468	0.476
B	3.90	4.10	0.153	0.161
C	15.70	16.30	0.618	0.641
D	7.40	7.60	0.291	0.299
E	10.80	11.00	0.425	0.433
F	10.60	10.80	0.417	0.425
G	1.50	n/a	0.059	n/a
H	1.50	1.60	0.059	0.062

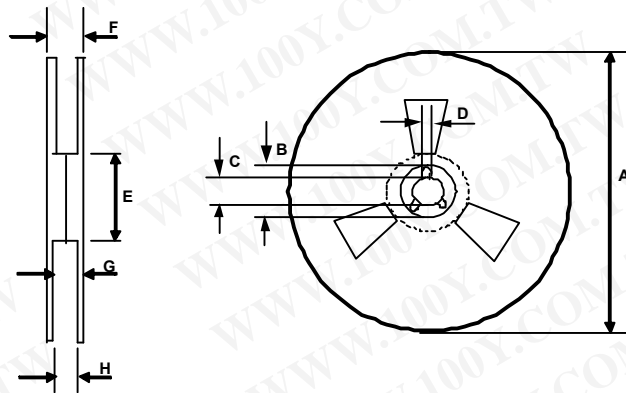

REEL DIMENSIONS FOR 16SOICW

Code	Metric		Imperial	
	Min	Max	Min	Max
A	329.60	330.25	12.976	13.001
B	20.95	21.45	0.824	0.844
C	12.80	13.20	0.503	0.519
D	1.95	2.45	0.767	0.096
E	98.00	102.00	3.858	4.015
F	n/a	22.40	n/a	0.881
G	18.50	21.10	0.728	0.830
H	16.40	18.40	0.645	0.724

IR2213(s) & (PbF)

LEADFREE PART MARKING INFORMATION

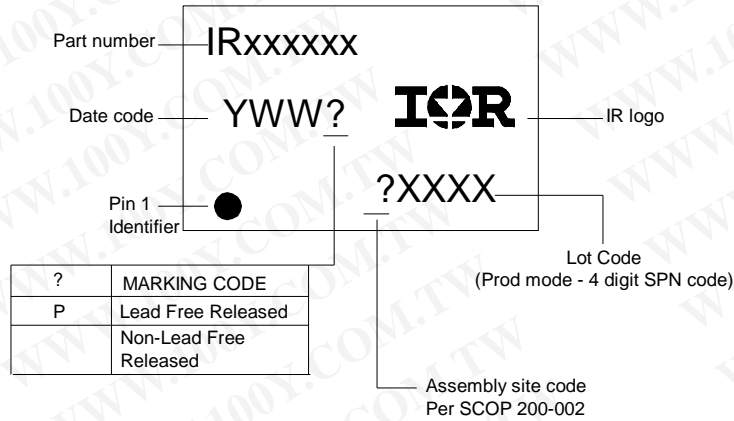

ORDER INFORMATION

Basic Part (Non-Lead Free)

14-Lead PDIP IR2213 order IR2213
 16-Lead SOIC IR2213S order IR2213S
 16-Lead SOIC Tape & Reel order IR2213STR

Leadfree Part

14-Lead PDIP IR2213 order IR2213PbF
 16-Lead SOIC IR2213S order IR2213SPbF
 16-Lead SOIC Tape & Reel order IR2213STRPbF