

Features

- Two independent comparators
- Supply voltage: +5 V to ±15 V
- Typically 80 ns response time at ±15 V
- Minimum fan-out of two each side
- Maximum input current of 1 μA over the operating temperature range
- Inputs and outputs can be isolated from system ground
- High common-mode slew rate

Description

These products are precision high-speed dual comparators designed to operate over a wide range of supply voltages down to a single 5 V logic supply and ground. They feature low input currents and high gains.

The open collector of the output stage makes them compatible with transistor-transistor logic (TTL) as well as capable of driving lamps and relays at currents up to 25 mA.

Although designed primarily for applications requiring operation from digital logic supplies, these comparators are fully specified for power supplies up to ±15 V.

They feature faster response times than the LM111 at the expense of higher current consumption. However, the high speed, wide operating voltage range and low package count make the LM119, LM219, and LM319 much more versatile.

勝特力材料 886-3-5753170
 勝特力电子(上海) 86-21-34970699
 勝特力电子(深圳) 86-755-83298787
[Http://www.100y.com.tw](http://www.100y.com.tw)

Contents

1	Schematic diagram	3
2	Absolute maximum ratings and operating conditions	4
3	Electrical characteristics	5
4	Typical application diagrams	9
5	Package information	10
	5.1 DIP14 package information	10
	5.2 SO-14 package information	11
6	Ordering information	12
7	Revision history	12

勝特力材料 886-3-5753170
 勝特力电子(上海) 86-21-34970699
 勝特力电子(深圳) 86-755-83298787
[Http://www.100y.com.tw](http://www.100y.com.tw)



1 Schematic diagram

Figure 1. Circuit schematics (1/2 LM119)

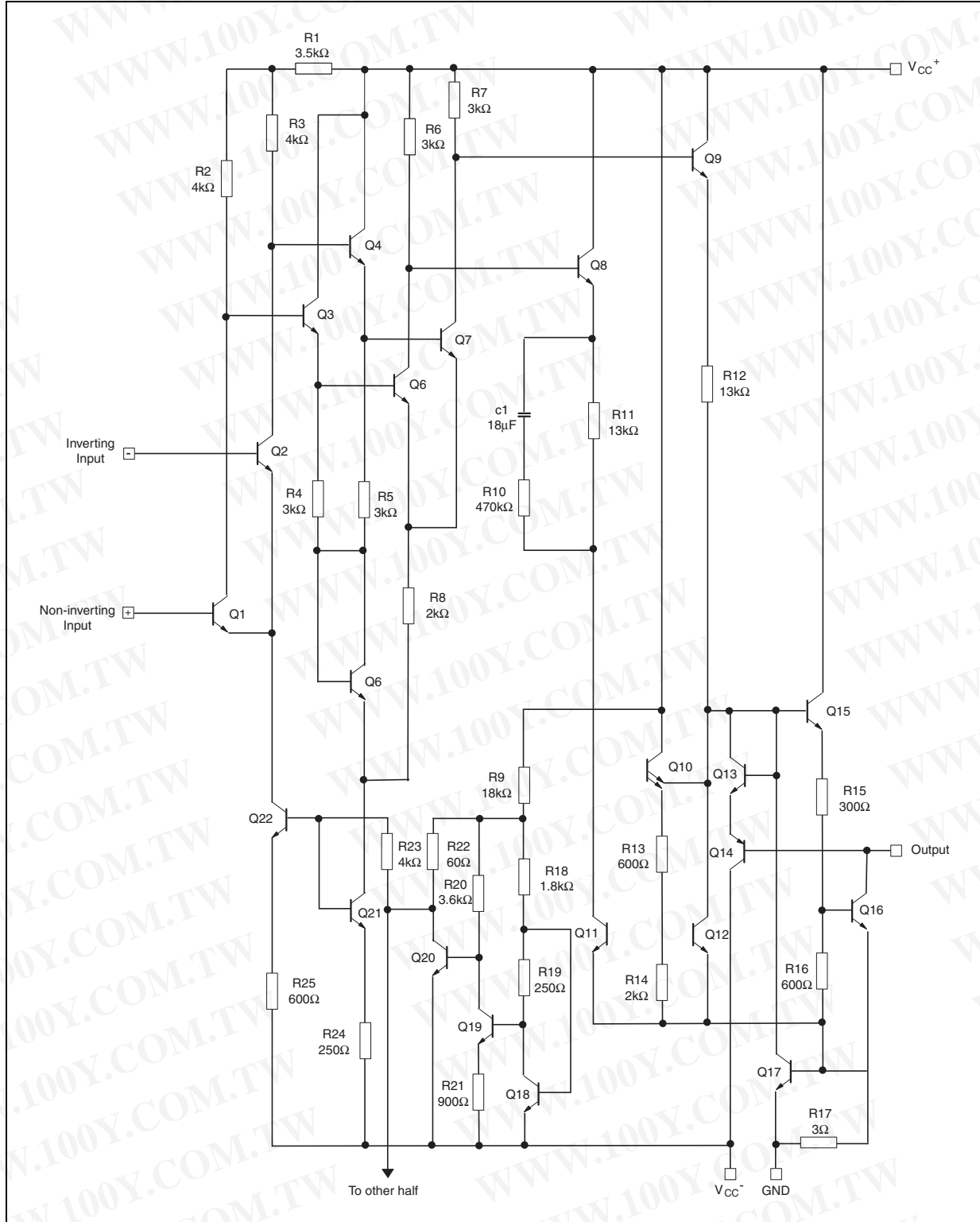

2 Absolute maximum ratings and operating conditions

Table 1. Absolute maximum ratings (AMR)

Symbol	Parameter	Value	Unit
$V_o - V_{CC}^-$	Output to negative supply voltage	36	V
V_{CC}^-	Negative supply voltage	-25	
V_{CC}^+	Positive supply voltage	18	
V_{id}	Differential input voltage	± 5	
V_i	Input voltage ⁽¹⁾	± 15	
	Output short-circuit to ground	Infinite	
T_j	Maximum junction temperature	150	°C
T_{stg}	storage temperature range	-65 to +150	
R_{thja}	Thermal resistance junction to ambient ⁽²⁾⁽³⁾		°C/W
	DIP14 SO-14	80 105	
R_{thjc}	Thermal resistance junction to case ⁽²⁾⁽³⁾		
	DIP14 SO-14	33 31	
ESD	HBM: human body model ⁽⁴⁾	400	V
	MM: machine model ⁽⁵⁾	100	
	CDM: charged device model ⁽⁶⁾	1500	

- For supply voltages lower than ± 15 V the absolute maximum input voltage is equal to the supply voltage.
- Short-circuits can cause excessive heating. Destructive dissipation can result from simultaneous short-circuits on all amplifiers.
- R_{th} are typical values.
- Human body model: 100 pF discharged through a 1.5 k Ω resistor between two pins of the device, done for all couples of pin combinations with other pins floating.
- Machine model: a 200 pF cap is charged to the specified voltage, then discharged directly between two pins of the device with no external series resistor (internal resistor < 5 Ω), done for all couples of pin combinations with other pins floating.
- Charged device model: all pins and the package are charged together to the specified voltage and then discharged directly to the ground through only one pin. This is done for all pins.

Table 2. Operating conditions

Symbol	Parameter	Value	Unit
V_{CC}	Supply voltage	5 to ± 15	V
T_{oper}	Operating free-air temperature range		°C
	LM119	-55 to + 125	
	LM219	-45 to + 105	
	LM319	0 to + 70	

勝特力材料 886-3-5753170
 勝特力电子(上海) 86-21-34970699
 勝特力电子(深圳) 86-755-83298787
[Http://www.100y.com.tw](http://www.100y.com.tw)

3 Electrical characteristics

Table 3. $V_{CC} = \pm 15\text{ V}$, $T_{amb} = +25\text{ }^\circ\text{C}$ (unless otherwise specified)

Symbol	Parameter	LM119, LM219			LM319			Unit
		Min.	Typ.	Max.	Min	Typ.	Max.	
V_{io}	Input offset voltage ($R_s \leq 5\text{ k}\Omega$) ⁽¹⁾⁽²⁾ $T_{min} \leq T_{amb} \leq T_{max}$		0.7	4 7		2	8 10	mV
I_{io}	Input offset current ⁽¹⁾ $T_{min} \leq T_{amb} \leq T_{max}$		30	75 100		80	200 300	nA
I_{ib}	Input bias current ⁽¹⁾ $T_{min} \leq T_{amb} \leq T_{max}$		150	500 1000		250	1000 1200	nA
A_{vd}	Large signal voltage gain	10	40		8	40		V/mV
I_{CC}^+	Positive supply current $V_{CC} = \pm 15\text{ V}$ $V_{CC}^+ = +5\text{ V}$, $V_{CC}^- = 0\text{ V}$		8 4.3	11.5		8 4.3	12.5	mA
I_{CC}^-	Negative supply current		3	4.5		3	5	mA
V_{icm}	Input common mode voltage range $V_{CC} = \pm 15\text{ V}$ $V_{CC}^+ = +5\text{ V}$, $V_{CC}^- = 0\text{ V}$	± 12 1	± 13	3	± 12 1	± 13	3	V
V_{OL}	Low level output voltage $I_o = 25\text{ mA}$ $V_i \leq -5\text{ mV}$ $V_i \leq -10\text{ mV}$ $T_{min} \leq T_{amb} \leq T_{max}$ $V_{CC}^+ \geq +4.5\text{ V}$, $V_{CC}^- = 0\text{ V}$, $I_{o(sink)} < 3.2\text{ mA}$ $V_i \leq -6\text{ mV}$ $V_i \leq -10\text{ mV}$		0.75 0.23	1.5 0.4		0.75 0.3	1.5 0.4	V
I_{OH}	High level output current ($V_o = +35\text{ V}$) $V_i \geq 5\text{ mV}$ $V_i \geq 10\text{ mV}$ $T_{min} \leq T_{amb} \leq T_{max}$, $V_i \geq 5\text{ mV}$		0.2 1	2 10		0.2	10	μA
t_{res}	Response time ⁽³⁾		80			80		ns

- These specifications apply for $V_{CC} = \pm 15\text{ V}$, unless otherwise stated. The offset voltage, offset current and bias current specifications apply for any supply voltage from a single +5 V up to $\pm 15\text{ V}$ supplies. The offset voltages and offset current given are the maximum values required to drive the output down to 1V or up to +14 V with a 1 mA load current. Thus, these parameters define an error band and take into account the worst case effects of voltage gain and input impedance.
- At output switch point, $V_o \approx 1.4\text{ V}$, no load, with V_{CC} from 5 V to $\pm 15\text{ V}$ and over the full input common-mode range.
- The response time specified is for a 100 mV input step with 5 mV overdrive.

勝特力材料 886-3-5753170
 勝特力电子(上海) 86-21-34970699
 勝特力电子(深圳) 86-755-83298787
[Http://www.100y.com.tw](http://www.100y.com.tw)

Figure 2. Input bias currents (LM119, LM219)

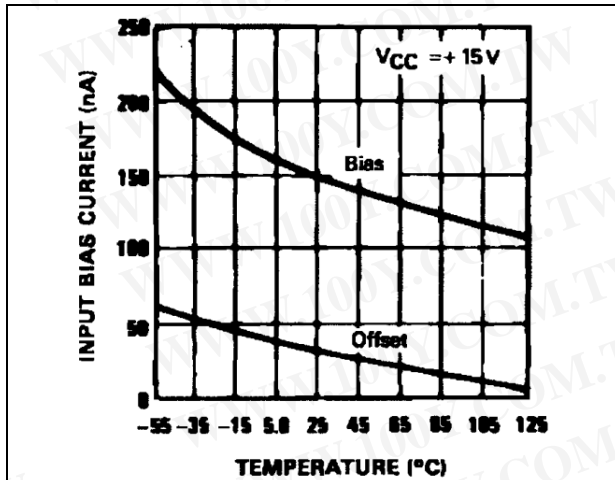

Figure 3. Common mode limits (LM119, LM219)

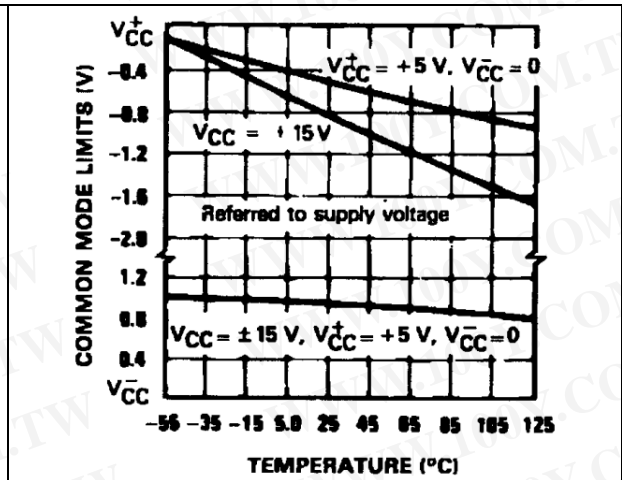

Figure 4. Output saturation voltage (LM119, LM219)

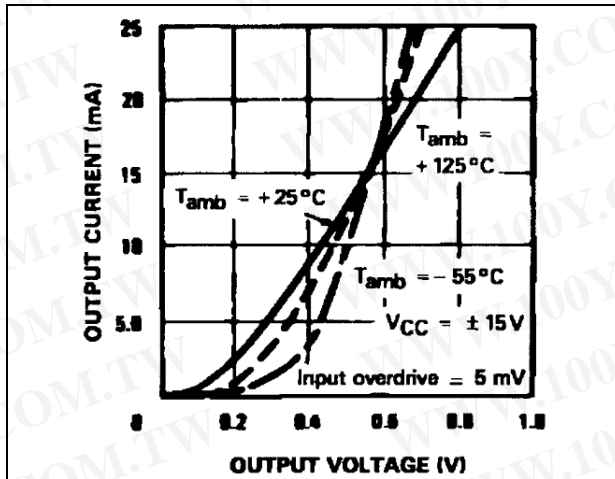

Figure 5. Supply current (LM119, LM219)

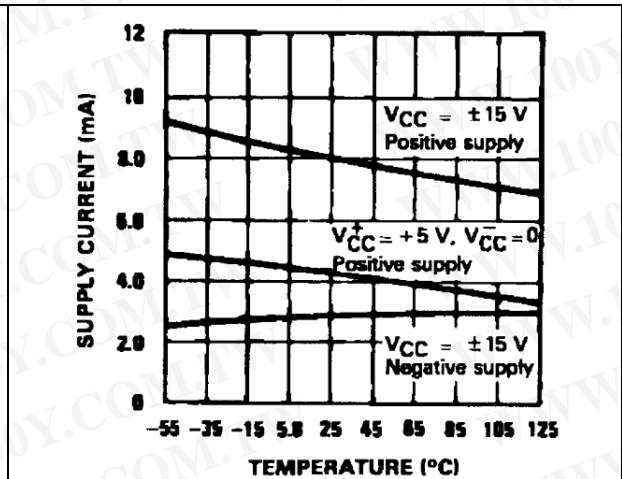

Figure 6. Supply current (LM119, LM219)

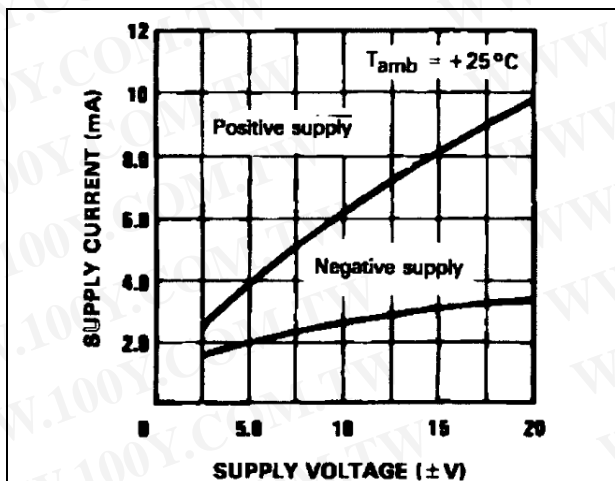
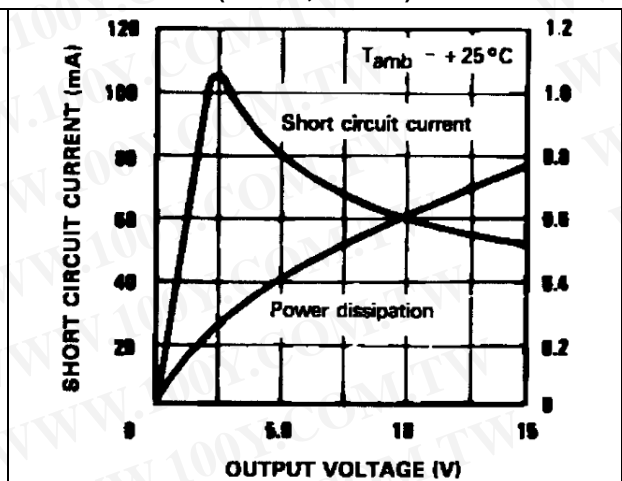

Figure 7. Output limiting characteristics (LM119, LM219)



勝特力材料 886-3-5753170
 勝特力电子(上海) 86-21-34970699
 勝特力电子(深圳) 86-755-83298787
[Http://www.100y.com.tw](http://www.100y.com.tw)

Figure 8. Input bias currents (LM319)

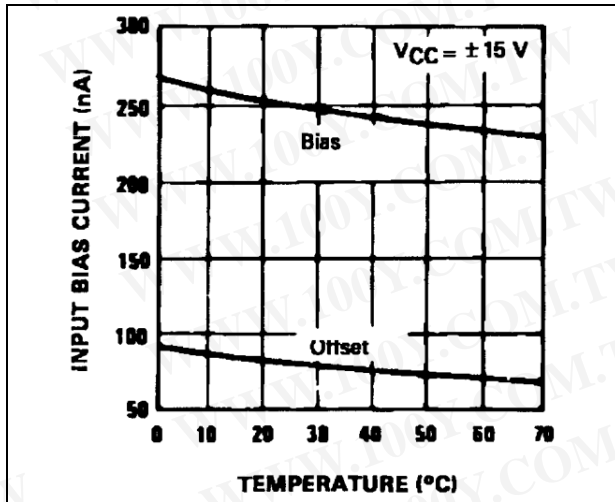

Figure 9. Common mode limits (LM319)

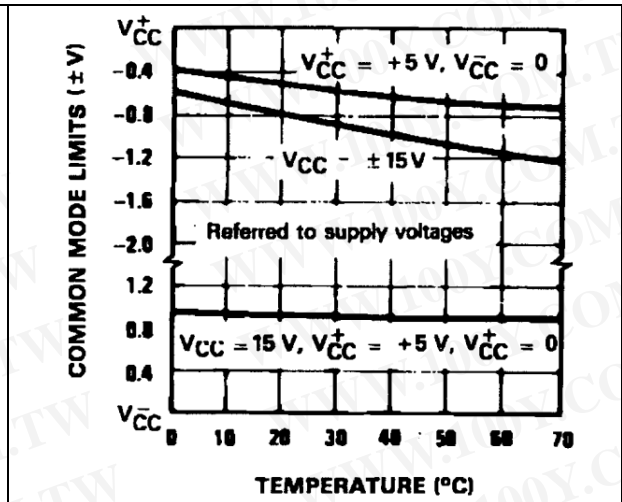

Figure 10. Output saturation voltage (LM319)

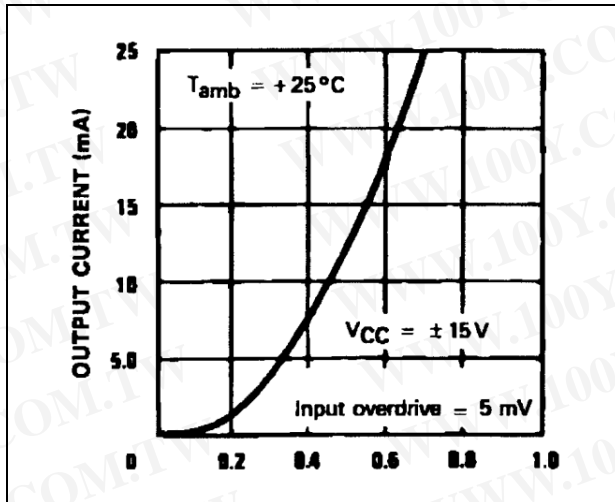

Figure 11. Supply current (LM319)

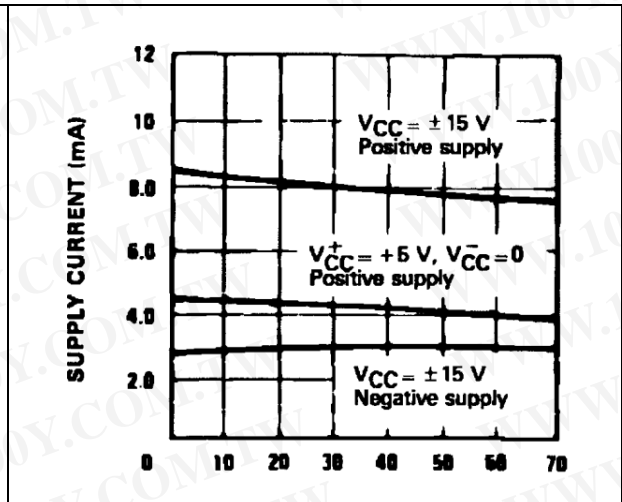

Figure 12. Transfer function

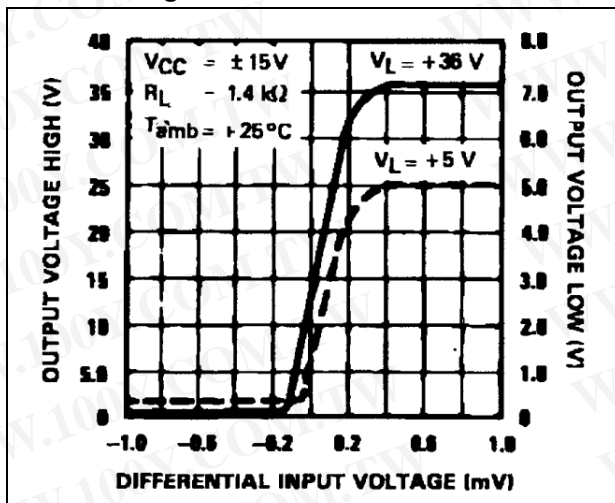

Figure 13. Input characteristics

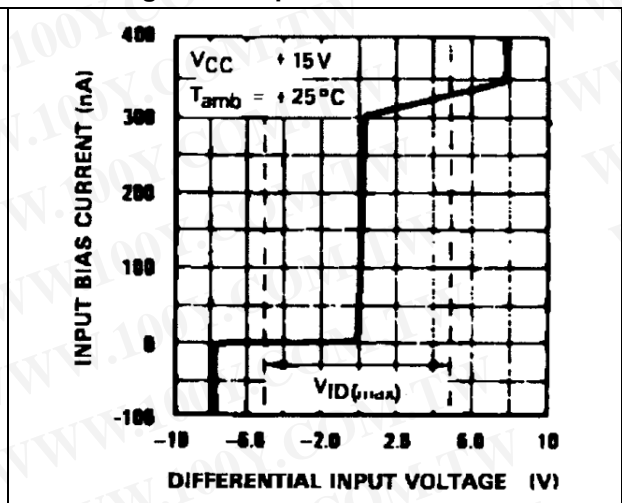

Figure 14. Response time on falling edge, $V_{CC} = \pm 15\text{ V}$

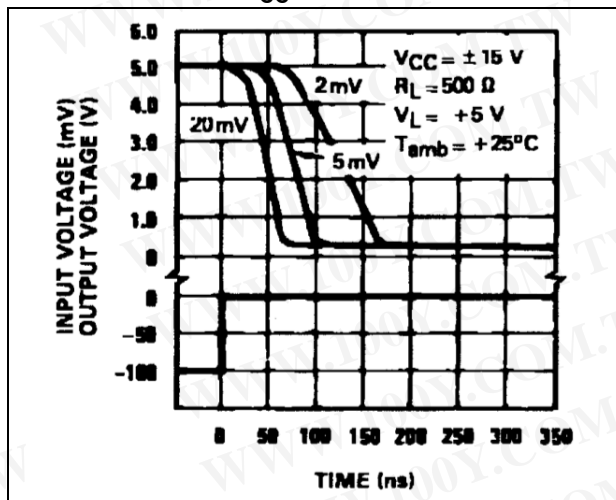

Figure 15. Response time on rising edge, $V_{CC} = \pm 5\text{ V}$

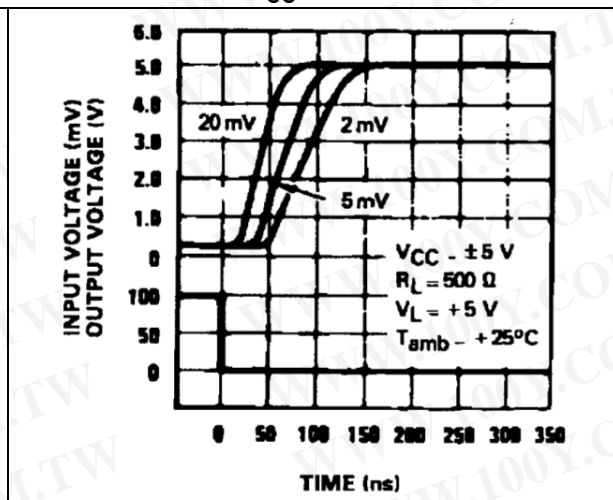

Figure 16. Response time on falling edge, $V_{CC} = \pm 5\text{ V}$

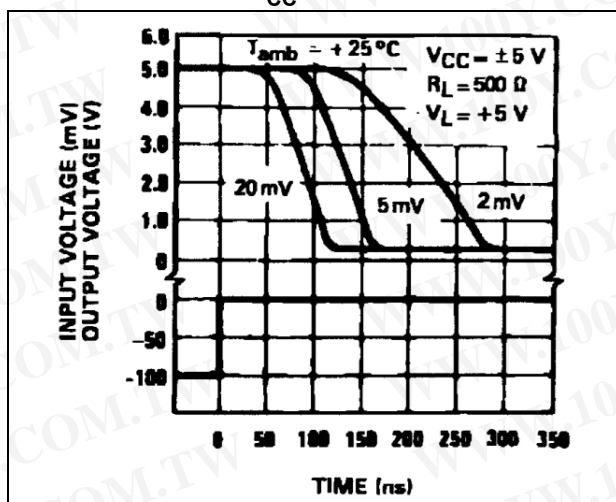
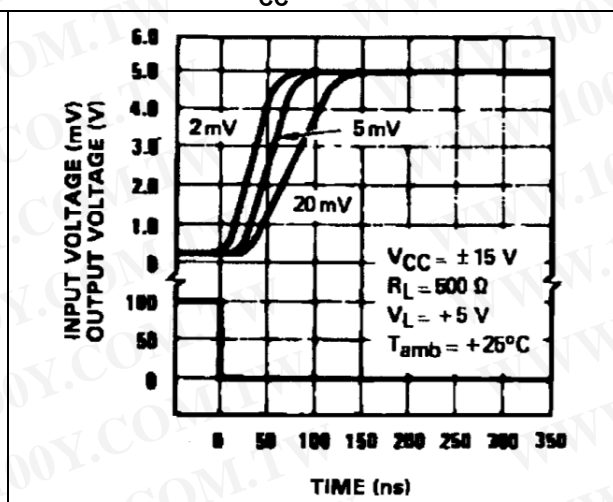

Figure 17. Response time on rising edge, $V_{CC} = \pm 15\text{ V}$



勝特力材料 886-3-5753170
 勝特力电子(上海) 86-21-34970699
 勝特力电子(深圳) 86-755-83298787
[Http://www.100y.com.tw](http://www.100y.com.tw)

4 Typical application diagrams

Figure 18. Relay driver

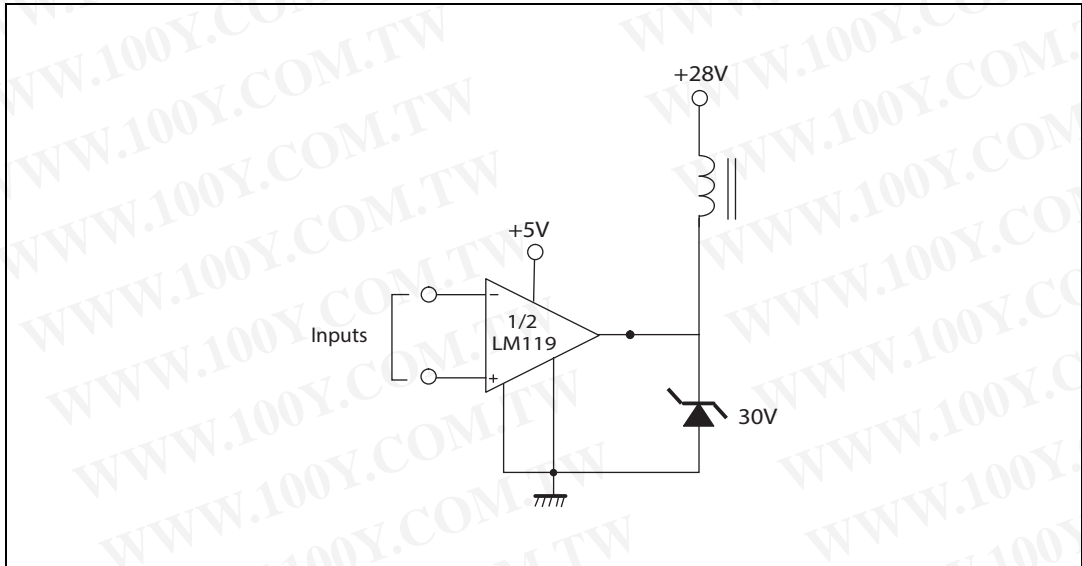
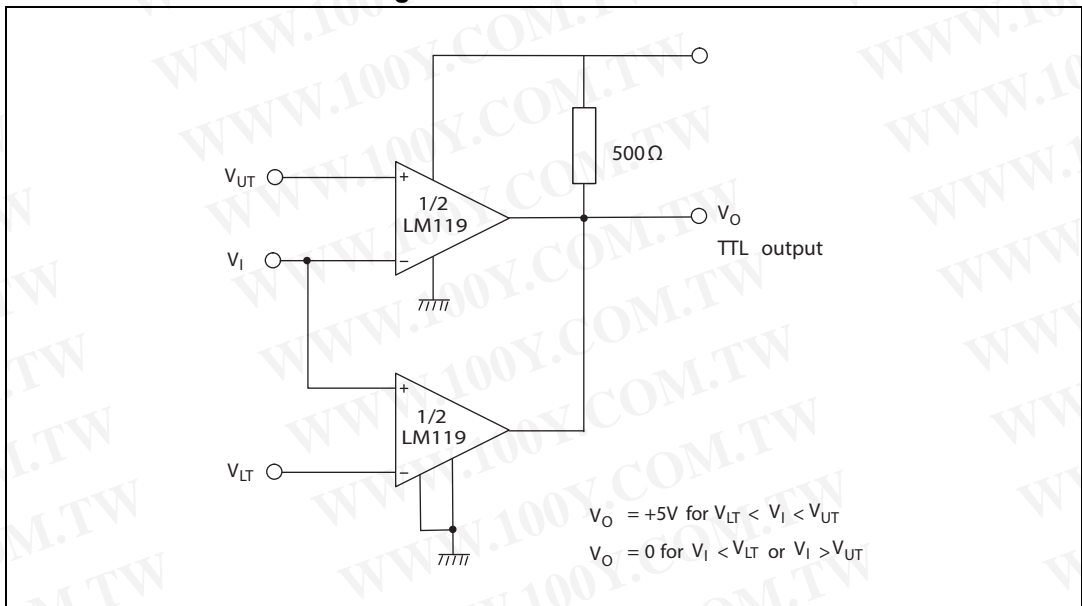

Figure 19. Window detector



勝特力材料 886-3-5753170
 勝特力电子(上海) 86-21-34970699
 勝特力电子(深圳) 86-755-83298787
[Http://www.100y.com.tw](http://www.100y.com.tw)

5 Package information

In order to meet environmental requirements, ST offers these devices in different grades of ECOPACK® packages, depending on their level of environmental compliance. ECOPACK® specifications, grade definitions and product status are available at: www.st.com. ECOPACK® is an ST trademark.

5.1 DIP14 package information

Figure 20. DIP14 package mechanical drawing

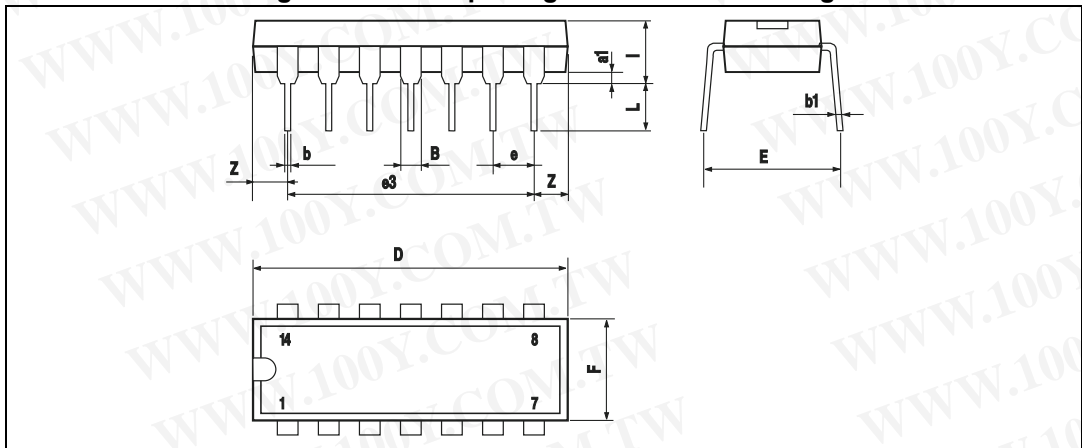

Table 4. DIP14 package mechanical data

Ref.	Dimensions					
	Millimeters			Inches		
	Min.	Typ.	Max.	Min.	Typ.	Max.
a1	0.51			0.020		
B	1.39		1.65	0.055		0.065
b		0.5			0.020	
b1		0.25			0.010	
D			20			0.787
E		8.5			0.335	
e		2.54			0.100	
e3		15.24			0.600	
F			7.1			0.280
I			5.1			0.201
L		3.3			0.130	
Z	1.27		2.54	0.050		0.100

5.2 SO-14 package information

Table 5. SO-14 package mechanical drawing

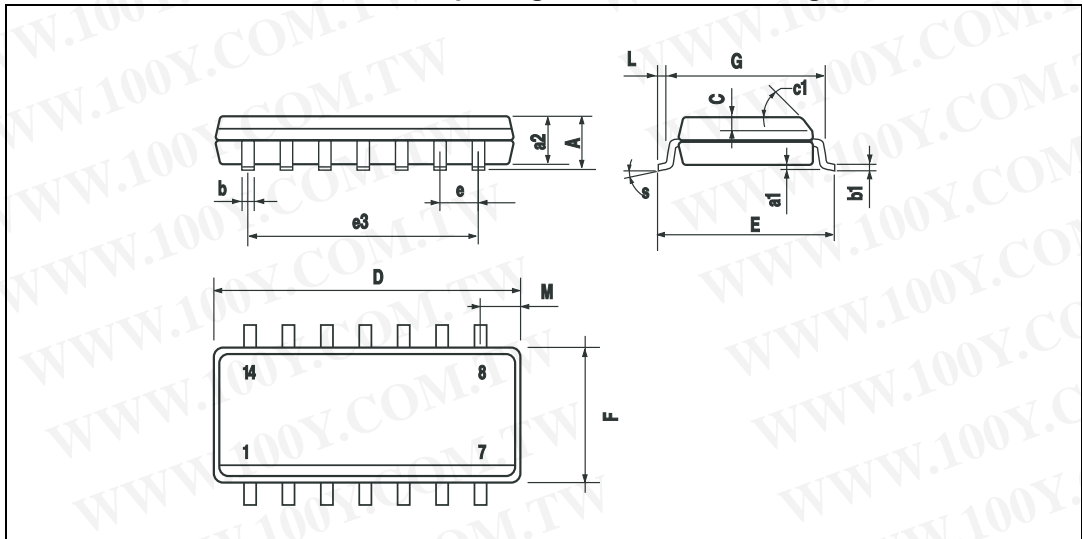

Table 6. SO-14 package mechanical data

Ref.	Dimensions					
	Millimeters			Inches		
	Min.	Typ.	Max.	Min.	Typ.	Max.
A			1.75			0.068
a1	0.1		0.2	0.003		0.007
a2			1.65			0.064
b	0.35		0.46	0.013		0.018
b1	0.19		0.25	0.007		0.010
C		0.5			0.019	
c1	45° (typ.)					
D	8.55		8.75	0.336		0.344
E	5.8		6.2	0.228		0.244
e		1.27			0.050	
e3		7.62			0.300	
F	3.8		4.0	0.149		0.157
G	4.6		5.3	0.181		0.208
L	0.5		1.27	0.019		0.050
M			0.68			0.026
S	8° (max.)					

6 Ordering information

Figure 21. Order codes

Order code	Temperature range	Package	Packaging	Marking
LM119N	-55 °C to +125 °C	DIP14	Tube	LM119N
LM119D LM119DT		SO-14	Tube or Tape and reel	119
LM219N	-45 °C to +105 °C	DIP14	Tube	LM219N
LM219D LM219DT		SO-14	Tube or Tape and reel	219
LM319N	0 °C to +70 °C	DIP14	Tube	LM319N
LM319D LM319DT		SO-14	Tube or Tape and reel	319

7 Revision history

Figure 22. Document revision history

Date	Revision	Changes
5-Jul-2002	1	Initial release.
28-Jan-2007	2	Added ESD, R_{thja} parameters in Table 1: Absolute maximum ratings (AMR) . Expanded orderable parts table, see Table 21: Order codes . Updated document format.
26-Mar-2013	3	Minimum operating temperature changed from -40 °C to -45 °C. Updated titles of Figure 14 , Figure 15 , Figure 16 , and Figure 17 .

勝特力材料 886-3-5753170
 勝特力电子(上海) 86-21-34970699
 勝特力电子(深圳) 86-755-83298787
[Http://www.100y.com.tw](http://www.100y.com.tw)

勝特力材料 886-3-5753170
勝特力电子(上海) 86-21-34970699
勝特力电子(深圳) 86-755-83298787
[Http://www.100y.com.tw](http://www.100y.com.tw)

Please Read Carefully:

Information in this document is provided solely in connection with ST products. STMicroelectronics NV and its subsidiaries ("ST") reserve the right to make changes, corrections, modifications or improvements, to this document, and the products and services described herein at any time, without notice.

All ST products are sold pursuant to ST's terms and conditions of sale.

Purchasers are solely responsible for the choice, selection and use of the ST products and services described herein, and ST assumes no liability whatsoever relating to the choice, selection or use of the ST products and services described herein.

No license, express or implied, by estoppel or otherwise, to any intellectual property rights is granted under this document. If any part of this document refers to any third party products or services it shall not be deemed a license grant by ST for the use of such third party products or services, or any intellectual property contained therein or considered as a warranty covering the use in any manner whatsoever of such third party products or services or any intellectual property contained therein.

UNLESS OTHERWISE SET FORTH IN ST'S TERMS AND CONDITIONS OF SALE ST DISCLAIMS ANY EXPRESS OR IMPLIED WARRANTY WITH RESPECT TO THE USE AND/OR SALE OF ST PRODUCTS INCLUDING WITHOUT LIMITATION IMPLIED WARRANTIES OF MERCHANTABILITY, FITNESS FOR A PARTICULAR PURPOSE (AND THEIR EQUIVALENTS UNDER THE LAWS OF ANY JURISDICTION), OR INFRINGEMENT OF ANY PATENT, COPYRIGHT OR OTHER INTELLECTUAL PROPERTY RIGHT.

ST PRODUCTS ARE NOT AUTHORIZED FOR USE IN WEAPONS. NOR ARE ST PRODUCTS DESIGNED OR AUTHORIZED FOR USE IN: (A) SAFETY CRITICAL APPLICATIONS SUCH AS LIFE SUPPORTING, ACTIVE IMPLANTED DEVICES OR SYSTEMS WITH PRODUCT FUNCTIONAL SAFETY REQUIREMENTS; (B) AERONAUTIC APPLICATIONS; (C) AUTOMOTIVE APPLICATIONS OR ENVIRONMENTS, AND/OR (D) AEROSPACE APPLICATIONS OR ENVIRONMENTS. WHERE ST PRODUCTS ARE NOT DESIGNED FOR SUCH USE, THE PURCHASER SHALL USE PRODUCTS AT PURCHASER'S SOLE RISK, EVEN IF ST HAS BEEN INFORMED IN WRITING OF SUCH USAGE, UNLESS A PRODUCT IS EXPRESSLY DESIGNATED BY ST AS BEING INTENDED FOR "AUTOMOTIVE, AUTOMOTIVE SAFETY OR MEDICAL" INDUSTRY DOMAINS ACCORDING TO ST PRODUCT DESIGN SPECIFICATIONS. PRODUCTS FORMALLY ESCC, QML OR JAN QUALIFIED ARE DEEMED SUITABLE FOR USE IN AEROSPACE BY THE CORRESPONDING GOVERNMENTAL AGENCY.

Resale of ST products with provisions different from the statements and/or technical features set forth in this document shall immediately void any warranty granted by ST for the ST product or service described herein and shall not create or extend in any manner whatsoever, any liability of ST.

ST and the ST logo are trademarks or registered trademarks of ST in various countries.

Information in this document supersedes and replaces all information previously supplied.

The ST logo is a registered trademark of STMicroelectronics. All other names are the property of their respective owners.

© 2013 STMicroelectronics - All rights reserved

STMicroelectronics group of companies

Australia - Belgium - Brazil - Canada - China - Czech Republic - Finland - France - Germany - Hong Kong - India - Israel - Italy - Japan - Malaysia - Malta - Morocco - Philippines - Singapore - Spain - Sweden - Switzerland - United Kingdom - United States of America

www.st.com

