



## CMOS Video Multiplexer/Amplifier

### General Description

The MAX452 is a unity-gain stable, 50MHz video amplifier capable of driving a 75 ohm load directly. The MAX453, MAX454, and MAX455 combine the 50MHz video amplifier, of the MAX452, with an on-board multiplexer offering 2, 4, or 8 channels respectively. All of the MAX452 family devices operate from  $\pm 5V$  supplies and typically consume only 250mW.

Optimized for video applications, these amplifiers will directly drive a 150 ohm load to  $\pm 2V$ , and will swing  $\pm 1V$  into a 75 ohm load. All amplifiers are unity-gain stable and do not require external frequency compensation components. The MAX453/454/455 operate as positive-gain amplifiers, gain being set by two external resistors. Since they are connected as non-inverting amplifiers, their minimum closed-loop gain is 0dB. In most applications the amplifier's closed-loop gain will be set at 0dB or +6dB (1 V/V or 2 V/V), which guarantees a minimum bandwidth of 25MHz.

### Applications

- Video signal multiplexing
- 75 ohm cable drivers
- Driving flash converters
- Video Crosspoint Switches

### Features

- ◆ Unity-gain bandwidth of 50MHz typ.
- ◆ Low input capacitance: 7pF typ.
- ◆ No frequency-compensation required
- ◆ Low power operation: 250mW typ.
- ◆ Low bias current: 10pA typ.
- ◆ Directly drives 75 ohm cable
- ◆ 70 dB typical OFF isolation at 4 MHz

### Ordering Information

PART	TEMP. RANGE	PACKAGE
MAX452CPA	0°C to +70°C	8 lead plastic DIP
MAX452CSA	0°C to +70°C	8 lead small-outline
MAX452C/D	0°C to +70°C	Dice
MAX452EPA	-40°C to +85°C	8 lead plastic DIP
MAX452EJA	-40°C to +85°C	8 lead Cerdip
MAX452MJA	-55°C to +125°C	8 lead Cerdip
MAX453CPA	0°C to +70°C	8 lead plastic DIP
MAX453CSA	0°C to +70°C	8 lead small-outline
MAX453EPA	-40°C to +85°C	8 lead plastic DIP
MAX453EJA	-40°C to +85°C	8 lead Cerdip
MAX453MJA	-55°C to +125°C	8 lead Cerdip
MAX454CPD	0°C to +70°C	14 lead plastic DIP
MAX454CSD	0°C to +70°C	14 lead small-outline
MAX454EPD	-40°C to +85°C	14 lead plastic DIP
MAX454EJD	-40°C to +85°C	14 lead Cerdip

(Ordering Information Continued on Last Page.)

### Pin Configurations

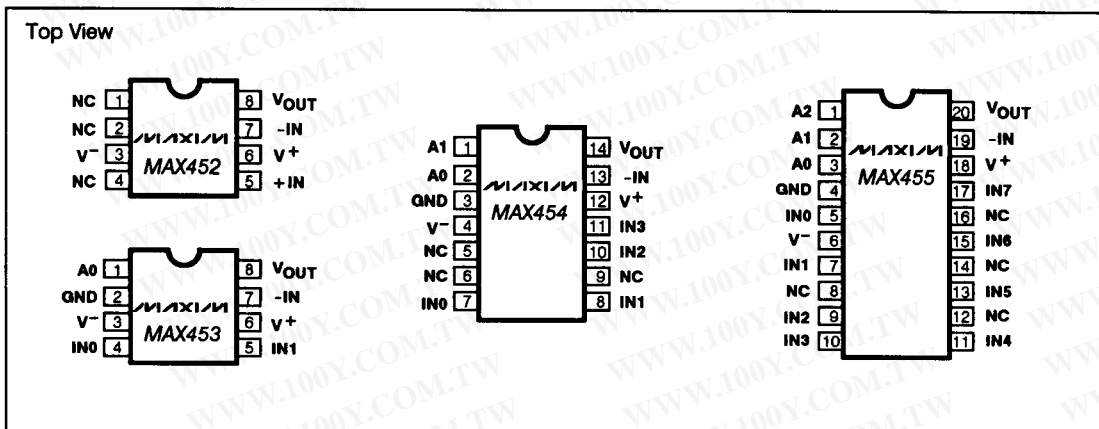

## CMOS Video Multiplexer/Amplifier

### ABSOLUTE MAXIMUM RATINGS

Total Supply Voltage ( $V^+$ to $V^-$ )	12 V	Lead temperature (Soldering, 10 sec)	300 °C
Positive Supply Voltage, $V^+$ (rel. GND)	+12V	Duration of Output Short-Circuit to ground	Indefinite
Negative Supply Voltage, $V^-$ (rel. GND)	-12V	Input Current, power on or off	
Analog Input Voltage	( $V^+$ ) + 0.3 V to ( $V^-$ ) - 0.3 V	Digital Inputs	+ 20 mA
Digital Input Voltage	-0.3 V to ( $V^+$ ) + 0.3 V	All other pins	± 50 mA
Storage Temperature Range	-65 °C to +160 °C	Continuous Total Power Dissipation ( $T_A = +70 °C$ )	
Operating Temperature Range		8 Pin CERDIP (derate 8.0mW/°C above 70 °C)	640mW
MAX452C, MAX453C	0 °C to +70 °C	14 Pin CERDIP (derate 9.5mW/°C above 70 °C)	760mW
MAX454C, MAX455C		20 Pin CERDIP (derate 11.1mW/°C above 70 °C)	890mW
MAX452E, MAX453E	-40 °C to +85 °C	8 Pin Plastic DIP (derate 8.3mW/°C above 70 °C)	660mW
MAX454E, MAX455E		14 Pin Plastic DIP (derate 10.0mW/°C above 70 °C)	800mW
MAX452M, MAX453M	-55 °C to +125 °C	20 Pin Plastic DIP (derate 11.1mW/°C above 70 °C)	890mW
MAX454M, MAX455M		8 Pin Small-Outline (derate 5.9mW/°C above 70 °C)	320mW
		14 Pin Small-Outline (derate 8.7mW/°C above 70 °C)	480mW
		20 Pin Small-Outline (derate 10.0mW/°C above 70 °C)	550mW

Stresses above those listed under "Absolute Maximum Ratings" may cause permanent damage to the device. These are stress ratings only and functional operation of the device at these or any other conditions above those indicated in the operational sections of the specifications is not implied. Exposure to absolute maximum rating conditions for extended periods may affect device reliability.

### ELECTRICAL CHARACTERISTICS MAX452/3/4/5

( $V^+ = +5V$ ,  $V^- = -5V$ ,  $-2V \leq V_{IN} \leq +2V$ , Output Load Resistor = 150Ω,  $T_A = +25 °C$  unless otherwise noted)

PARAMETER	SYMBOL	CONDITIONS	MIN.	TYP.	MAX.	UNITS
<b>VIDEO AMPLIFIER (MAX452/3/4/5)</b>						
Input Voltage Range	$V_{IN}$	Over Temperature Range (Note 2)	-2		2	V
Input Offset Voltage	$V_{OS}$			2	5	mV
Offset Voltage Drift	$\Delta V_{OS}/\Delta T$	(Note 5)		20	100	μV/°C
Input Bias Current	$I_B$	$T_A = +25 °C$ (Note 1) Over Temperature Range (Notes 1,2) C E M		0.01 1 3 50	10 10 30 500	nA
Input Resistance	$R_{IN}$			$10^{11}$		Ω
Open-Loop Voltage Gain	$A_{VOL}$	$R_L = 1000\Omega$ $R_L = 150\Omega$ $R_L = 75\Omega$	180 45 25	260 70 38		V/V
Open-Loop Gain Drift	$\Delta A_{VOL}/\Delta T$	$R_L = 150\Omega$		0.5		%/°C
Common-Mode Rejection Ratio	CMRR	$-2V \leq V_{IN} \leq +2V$	60	80		dB
Power Supply Rejection Ratio	PSRR	$\pm 4.5V$ to $\pm 5.5V$	54	66		dB
Slew Rate	SR	(Note 5)	150	300		V/μs

**Note 1:** Input bias current includes the multiplexer's ON-state leakage current for the MAX453, MAX454 and MAX455.

**Note 2:** Operating temperature range for "C" devices is 0 °C to 70 °C, for "E" devices is -40 °C to +85 °C, and for "M" devices is -55 °C to +125 °C.

**Note 3:** Input test signal: 3.58MHz sinewave of amplitude 40 IRE superimposed on a linear ramp (0 to 100 IRE). The amplifier is operated at a gain of 2V/V while driving a 150 ohm load.

**Note 4:** Guaranteed over the voltage range,  $V^- < V_{IN} < V^+$ .

**Note 5:** Guaranteed by design.

(Continued on next page)

## CMOS Video Multiplexer/Amplifier

MAX452/3/4/5

### ELECTRICAL CHARACTERISTICS MAX452/3/4/5 (Continued)

( $V^+ = +5V$ ,  $V^- = -5V$ ,  $-2V < V_{in} < +2V$ , Output Load Resistor =  $150\Omega$ ,  $T_A = +25^\circ C$  unless otherwise noted)

PARAMETER	SYMBOL	CONDITIONS	MIN.	TYP.	MAX.	UNITS
<b>VIDEO AMPLIFIER (MAX452/3/4/5)</b>						
-3dB Bandwidth	GBW1	$A_V = 0dB$ , $R_L = 75\Omega$ (Note 5)	30	50		MHz
-3dB Bandwidth	GBW2	$A_V = 6dB$ , $R_L = 150\Omega$ (Note 5)	25	40		MHz
Differential Phase Error	DP	MAX452 (Notes 3, 5) MAX453/4/5 (Notes 3, 5)		0.2 1.2		deg
Differential Gain Error	DG	(Notes 3, 5)		0.5		%
Settling-Time to 1%	$t_S$	$\Delta V = 1V$ , $R_L = 150\Omega$ , $A_V = 6dB$		50		ns
Output Impedance	$R_{OUT}$	$f = 100kHz$ , $A_V = 0dB$		2		$\Omega$
Full-Scale Output Current	$I_{OUT}$	$R_L = 150\Omega$	$\pm 14$	$\pm 20$		mA
Output Voltage Swing	$V_{OUT}$	$R_L = 150\Omega$	$\pm 2.1$	$\pm 3.0$		V
Input Noise, dc to 40MHz	$V_n$	(Note 5)		0.15	0.5	$mV_{rms}$
Operating Supply Voltage	$V^+, V^-$		$\pm 4.5$		$\pm 5.5$	V
Supply Current	$I_S$	$V_{IN} = 0V$	20	25	30	mA
<b>MULTIPLEXER (MAX453/4/5)</b>						
Input Voltage Range	$V_{IN}$	Over Temperature	-2		2	V
OFF Input Leakage Current	$I_{OFF}$	$T_A = +25^\circ C$ (Note 4) Over Temperature Range (Notes 2, 4) C E M		0.01 1 3 50	10 10 30 500	nA
Logic Low Threshold	$V_{IL}$				0.8	V
Logic High Threshold	$V_{IH}$		2.4			V
Input Pullup/down Current	$I_{IL/IH}$			5	20	$\mu A$
Turn-ON Time	$t_{ON}$	(Note 5)		75	120	ns
Turn-OFF Time	$t_{OFF}$	(Note 5)		25	60	ns
Break-Before-Make Delay	$t_D$	(Note 5)	10	50		ns
Channel "ON" Capacitance	$C_{ON}$	(Note 5)		7	15	pF
Channel "OFF" Capacitance	$C_{OFF}$	(Note 5)		3.5	12	pF
Channel "OFF" Isolation	OIRR	$f_{IN} = 4MHz$ , $R_S = 75\Omega$ (Note 5) Channel 2 to Channel 3 All other Channels	45 60	55 70		dB

**Note 1:** Input bias current includes the multiplexer's ON-state leakage current for the MAX453, MAX454 and MAX455.

**Note 2:** Operating temperature range for "C" devices is  $0^\circ C$  to  $70^\circ C$ , for "E" devices is  $-40^\circ C$  to  $+85^\circ C$ , and for "M" devices is  $-55^\circ C$  to  $+125^\circ C$ .

**Note 3:** Input test signal: 3.58MHz sinewave of amplitude 40 IRE superimposed on a linear ramp (0 to 100 IRE). The amplifier is operated at a gain of 2V/V while driving a 150 ohm load.

**Note 4:** Guaranteed over the voltage range,  $V^- < V_{IN} < V^+$ .

**Note 5:** Guaranteed by design.

# CMOS Video Multiplexer/Amplifier

**MAX452/3/4/5**

**MAX452 AND MAX455 DIFFERENTIAL GAIN**

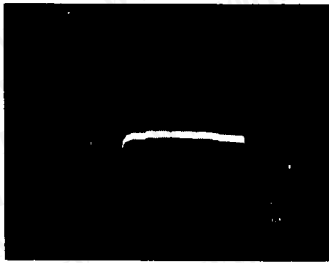

Input test signal: 3.58MHz sinewave of amplitude 40 IRE superimposed on a linear ramp (0 to 100 IRE). The amplifier is operated at a gain of 2V/V while driving a 150 ohm load.

**MAX452 DIFFERENTIAL PHASE**

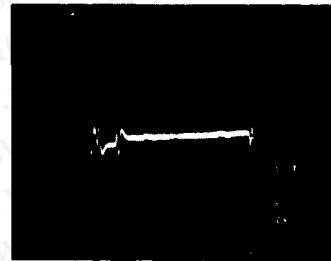

**MAX455 DIFFERENTIAL PHASE**

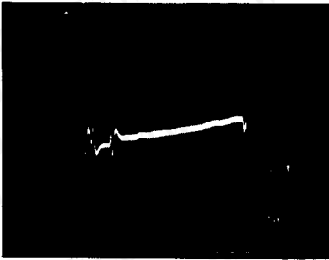

**MAX455 PULSE RESPONSE**

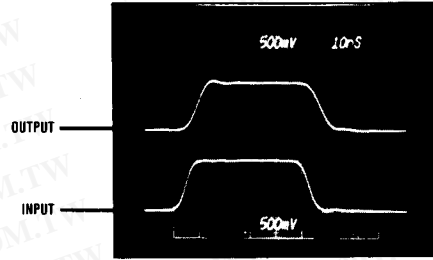

**OPEN-LOOP GAIN vs. FREQUENCY**

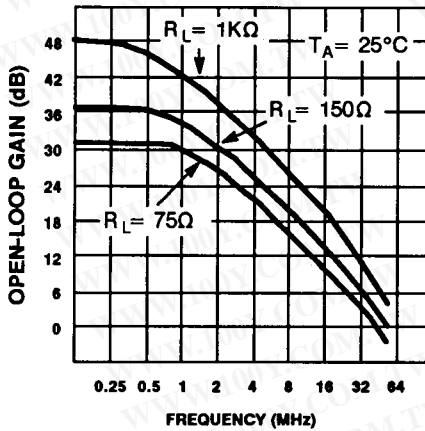

**OPEN-LOOP GAIN vs. TEMPERATURE**

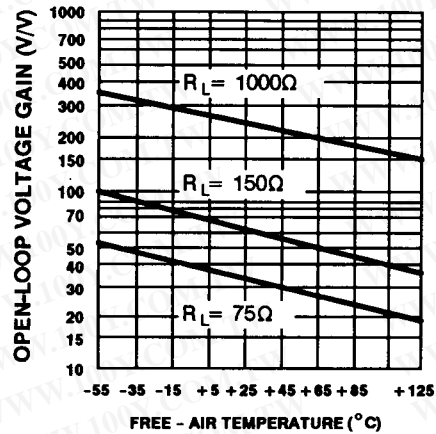

# CMOS Video Multiplexer/Amplifier

MAX452/3/4/5

## Pin Description

PIN NAME	PIN NUMBER				FUNCTION
	MAX452	MAX453	MAX454	MAX455	
V <sup>+</sup>	6	6	12	18	Positive Supply, +5V
V <sup>-</sup>	3	3	4	6	Negative Supply, -5V
V <sub>OUT</sub>	8	8	14	20	Amplifier output
-IN	7	7	13	19	Amplifier's inverting input
+IN	5	-	-	-	Amplifier's non-inv. input
IN0	-	4	7	5	Analog input, channel 0
IN1	-	5	8	7	Analog input, channel 1
IN2	-	-	10	9	Analog input, channel 2
IN3	-	-	11	10	Analog input, channel 3
IN4	-	-	-	11	Analog input, channel 4
IN5	-	-	-	13	Analog input, channel 5
IN6	-	-	-	15	Analog input, channel 6
IN7	-	-	-	17	Analog input, channel 7
A2	-	-	-	1	Channel select, MSB
A1	-	-	1	2	Channel select
A0	-	1	2	3	Channel select, LSB
GND	-	2	3	4	Logic Ground

## Detailed Description

The video amplifier is a low gain, wideband op-amp optimized for driving low impedance loads. Open-loop gain is about 40V/V with a 75 ohm load which introduces a small gain error. However, this can readily be trimmed by adjusting the gain-setting resistors.

The MAX452/3/4/5 series are unity-gain stable when driving resistive loads. They are optimized for driving 75 ohms at unity gain or 150 ohms at a gain of 2V/V with no frequency compensation components required. Generally, for the best transient response, the load resistance should be (in ohms) 75 x GAIN(V/V). Thus, at a gain of +6dB (2V/V), the amplifier's optimal load is 150 ohms. If a higher resistive load is used, the amplifier will show peaking near its -3dB frequency. If a capacitive load is being driven, such as the input to a flash converter, the load should be "isolated" by a series resistor to limit amplifier ringing, see Figure 4.

The bandwidth of the amplifier is affected by both the closed-loop gain and the load resistor. Table 1 lists the -3dB rolloff frequency for a MAX453/4/5 with different gains and optimal resistive loads. The MAX452, which doesn't have the input multiplexer, runs about 20% higher in bandwidth.

Table 1.  
Gain and Load Resistor Selection

GAIN (V/V)	f-3dB (MHz)	R1 (Ω)	R2 (Ω)	R <sub>load</sub> (Ω)
1	50	0	∞	75
2	40	1k	1k	150
5	30	4k	1k	390
10	18	9k	1k	750

The multiplexers feature break-before-make switches to insure that no two channels are ever connected together. Low DC offset voltage and high bandwidth allow the MAX455 to be cascaded to form a 64 channel system while retaining video signal fidelity.

Figure 1 shows a typical application of the MAX455. The circuit is being used to drive a back terminated 75 ohm cable. R3 and R4 terminate the cable at both ends. R3 also attenuates the signal by a factor of two, so to make up for the signal loss, the amplifier is run at a gain of 2V/V. This arrangement provides unity gain from signal input to

## CMOS Video Multiplexer/Amplifier

cable output. Amplifier closed-loop gain is set by R1 and R2 giving,

$$\frac{V_{OUT}}{V_{IN}} = \frac{G \times (R1 + R2)}{(G \times R2) + (R1 + R2)}$$

Where G is the open-loop gain of the amplifier, about 70V/V with a 150 ohm load. Capacitors C1 and C2 are power supply bypass capacitors.

Multiplexer channels are selected by the A0, A1, and A2 pins. These logic pins are compatible with either TTL or

CMOS logic. The GND pin (which is a logic ground, NOT an analog ground) should be connected to digital ground. Table 2 shows selected channels for the different states of the control lines. If A0, A1, and A2 are left floating, internal pullup/pulldown sources will hold A0 and A1 low, and A2 high. Thus, channel 0 is the default channel for the MAX453 and MAX454, while channel 4 is the default channel for the MAX455. Pullup/pulldown currents are typically around 5µA.

**Table 2.**  
**Channel Selection**

MAX453		MAX454			MAX455			
A0	Channel	A1	A0	Channel	A2	A1	A0	Channel
L	0*	L	L	0*	L	L	L	0
H	1	L	H	1	L	L	H	1
		H	L	2	L	H	L	2
		H	H	3	L	H	H	3
					H	L	L	4*
					H	L	H	5
					H	H	L	6
					H	H	H	7

\*Default channel if selection pins are left floating.

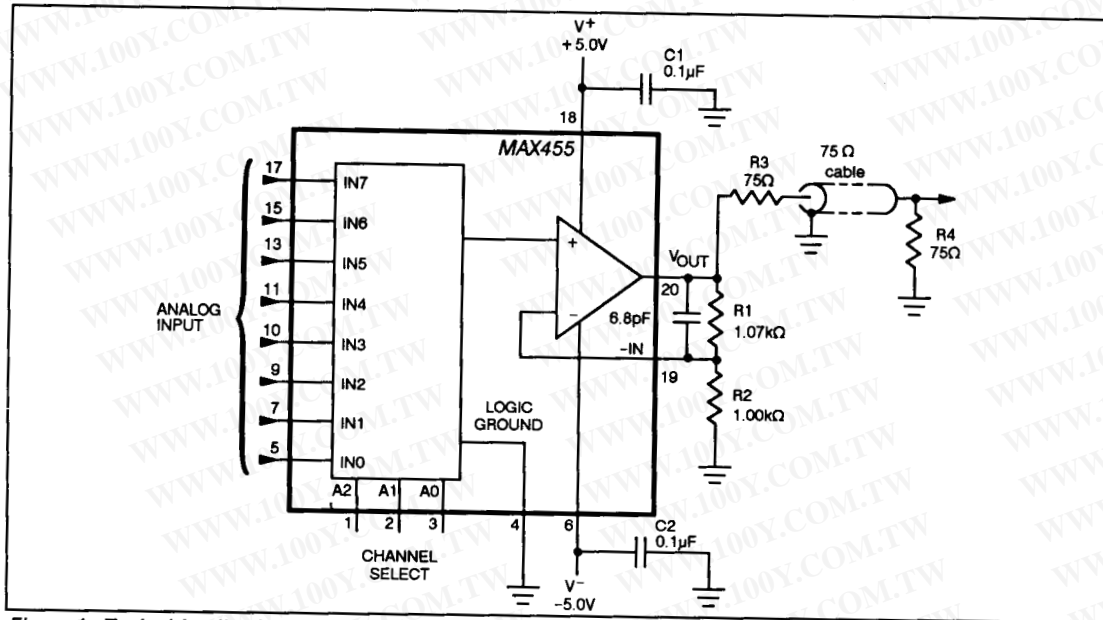

Figure 1. Typical Application

# CMOS Video Multiplexer/Amplifier

MAX452/3/4/5

## Typical Applications

Figure 2 shows the connections for a unity-gain amplifier. R1 and R2 adjust the gain to be nominally 1.00V/V. R3 is a 75 ohm load resistor. If precise unity-gain is not needed, R1 and R2 can be omitted and -IN can be connected directly to V<sub>OUT</sub>.

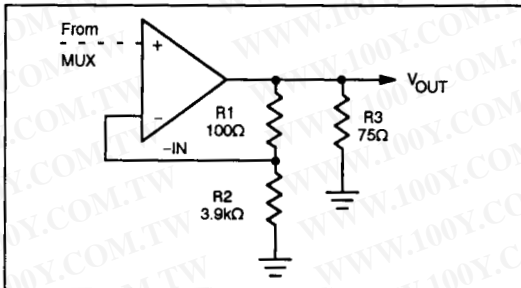

Figure 2. Unity-Gain Connections

Figure 3 shows how 64 channels can be multiplexed together. Eight MAX455s select 8 out of 64 channels, and a final MAX455 selects one of the 8 intermediate channels. The first eight MAX455s are connected as unity-gain amplifiers with 150 ohm load resistors. This results in a voltage gain of about 0.99V/V. The 150 ohm loads will also cause these unity-gain amplifiers to peak around 40MHz which tends to cancel the rolloff of the final amplifier running at a gain of 2V/V. The overall gain is adjusted by R1. The -3dB frequency is about 35MHz.

Figure 4 shows the amplifier driving a capacitive load. The 27 ohm resistor provides isolation between the capacitive

load and the amplifier output. This minimizes signal peaking at high frequencies. As a rule, the resistor should be chosen such that the RC product is 10ns or longer. This scheme shouldn't be used if R is greater than 150 ohms (or C is less than 100pF). The amplifier can drive 100pF directly without an isolation resistor.

The video amplifier is similar to a transconductance amplifier in that the output is a current proportional to the difference of the input voltage and the feedback voltage. G<sub>m</sub> is about 0.5 mA/mV. The output impedance of the amplifier is around 1k ohms. This gives an unloaded voltage gain of,

$$G_m \times R_o = 500 \text{ V/V}$$

or about 54 dB.

Video signals are often of one polarity, e.g., ranging from 0 to +1V full scale. When amplifying these signals, phase distortion can be reduced by biasing the output stage of the video amplifier as shown in Figure 5. Here a signal is driven 0 to +2V into a 150 ohm load. R2 provides 6.5 mA of drive to the load at mid scale (1V). The amplifier, instead of supplying 0 to 13mA, supplies a more symmetric ±8mA which reduces phase distortion to about 1 degree at 4 MHz. Because of the amplifier's finite gain of 0.5mA/mV, the current from R2 introduces an offset voltage. Adding R1 compensates for this offset. R3 and R4 set the closed-loop gain of the amplifier.

Care should be taken in laying out the printed circuit board connections to minimize cross-talk between channels. This can be augmented by using ground traces between the signal paths.

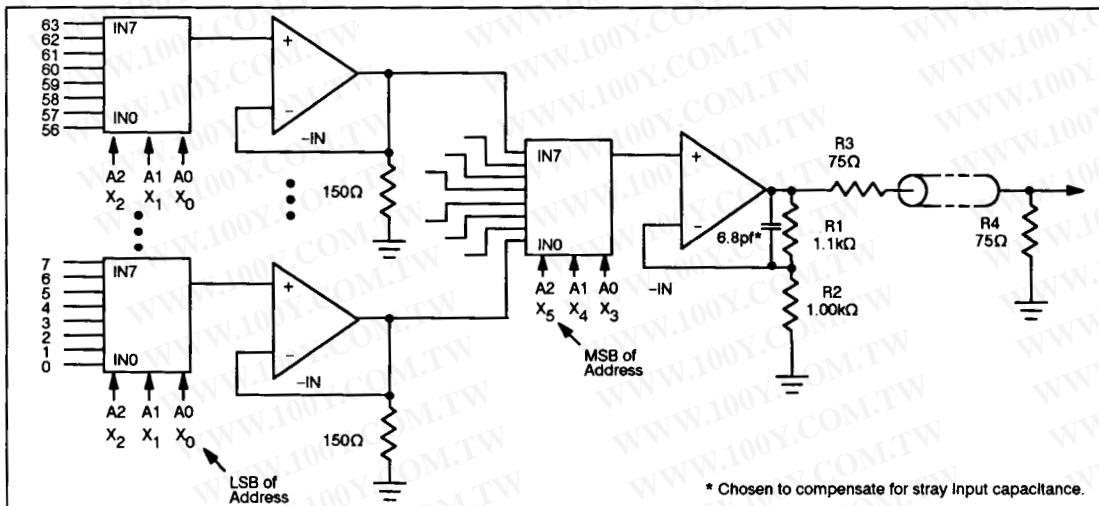

Figure 3. Nine MAX455s Used to Multiplex 64 Channels.

MAX452/3/4/5

## CMOS Video Multiplexer/Amplifier

Power supply voltages should be maintained to within  $\pm 5\%$  of the nominal  $\pm 5.00V$  values for optimum performance.

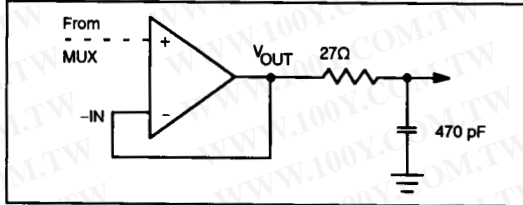
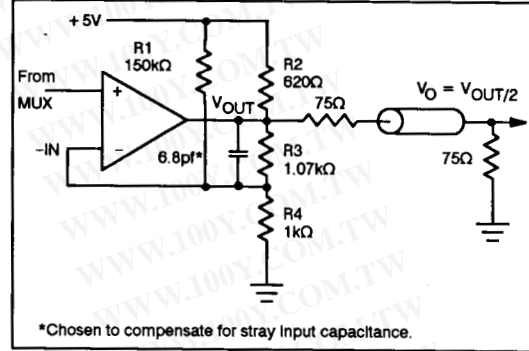

Figure 4. Isolating a Large Capacitive Load.



\*Chosen to compensate for stray input capacitance.  
 Figure 5. Minimizing Phase Distortion

### Ordering Information (continued)

PART	TEMP. RANGE	PACKAGE
MAX454MJD	-55°C to +125°C	14 lead Cerdip
MAX455CPP	0°C to +70°C	20 lead plastic DIP
MAX455CWP	0°C to +70°C	20 lead small-outline
MAX455C/D	0°C to +70°C	Die
MAX455EPP	-40°C to +85°C	20 lead plastic DIP
MAX455EJP	-40°C to +85°C	20 lead Cerdip
MAX455MJP	-55°C to +125°C	20 lead Cerdip

### Chip Topographies

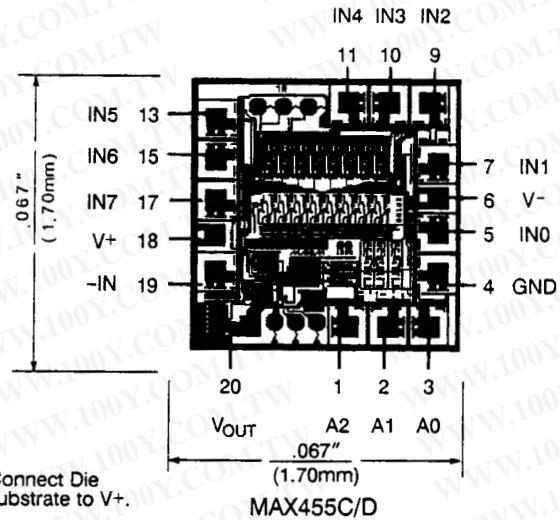
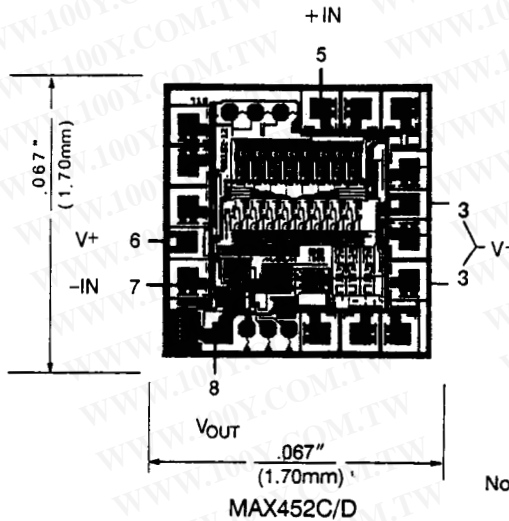

Note: Connect Die Substrate to V+.

Maxim cannot assume responsibility for use of any circuitry other than circuitry entirely embodied in a Maxim product. No circuit patent licenses are implied. Maxim reserves the right to change the circuitry and specifications without notice at any time.

8 Maxim Integrated Products, 120 San Gabriel Drive, Sunnyvale, CA 94086 (408) 737-7600

© 1996 Maxim Integrated Products

Printed USA

MAXIM is a registered trademark of Maxim Integrated Products.