

November 1996

## Quad, 3.5MHz, Operational Amplifier

### Features

- Slew Rate ..... 1.6V/ $\mu$ s
- Bandwidth..... 3.5MHz
- Input Voltage Noise ..... 9nV/ $\sqrt{\text{Hz}}$
- Input Offset Voltage..... 0.5mV
- Input Bias Current ..... 60nA
- Supply Range.....  $\pm 2\text{V}$  to  $\pm 20\text{V}$
- No Crossover Distortion
- Standard Quad Pinout

### Applications

- Universal Active Filters
- D3 Communications Filters
- Audio Amplifiers
- Battery-Powered Equipment

### Ordering Information

PART NUMBER	TEMP. RANGE (°C)	PACKAGE	PKG. NO.
HA1-4741-2	-55 to 125	14 Ld Cerdip	F14.3
HA1-4741-5	0 to 75	14 Ld Cerdip	F14.3
HA3-4741-5	0 to 75	14 Ld PDIP	E14.3
HA9P4741-9	-40 to 85	16 Ld SOIC	M16.3

### Description

HA-4741, which contains four amplifiers on a monolithic chip, provides a new measure of performance for general purpose operational amplifiers. Each amplifier in the HA-4741 has operating specifications that equal or exceed those of the 741-type amplifier in all categories of performance.

HA-4741 is well suited to applications requiring accurate signal processing by virtue of its low values of input offset voltage (0.5mV), input bias current (60nA) and input voltage noise (9nV/ $\sqrt{\text{Hz}}$  at 1kHz). 3.5MHz bandwidth, coupled with high open-loop gain, allow the HA-4741 to be used in designs requiring amplification of wide band signals, such as audio amplifiers. Audio application is further enhanced by the HA-4741's negligible output crossover distortion.

These excellent dynamic characteristics also make the HA-4741 ideal for a wide range of active filter designs. Performance integrity of multi-channel designs is assured by a high level of amplifier-to-amplifier isolation (69dB at 10kHz).

A wide range of supply voltages ( $\pm 2\text{V}$  to  $\pm 20\text{V}$ ) can be used to power the HA-4741, making it compatible with almost any system including battery-powered equipment.

HA-4741/883 product and data sheets available upon request.

**3**  
OPERATIONAL AMPLIFIERS

### Pinouts

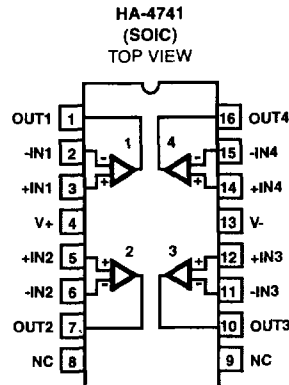
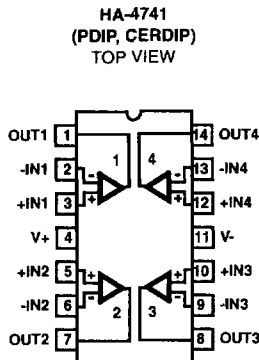

# HA-4741

## Absolute Maximum Ratings

$T_A = 25^\circ\text{C}$  Unless Otherwise Stated

Supply Voltage Between V+ and V- Terminals	40V
Differential Input Voltage	30V
Input Voltage	$V_{\text{SUPPLY}}$
Output Short Circuit Duration (Note 3)	Indefinite

## Operating Conditions

Temperature Range:

HA-4741-2	$-55^\circ\text{C}$ to $125^\circ\text{C}$
HA-4741-5	$0^\circ\text{C}$ to $75^\circ\text{C}$
HA-4741-9	$-40^\circ\text{C}$ to $85^\circ\text{C}$

**CAUTION:** Stresses above those listed in "Absolute Maximum Ratings" may cause permanent damage to the device. This is a stress only rating and operation of the device at these or any other conditions above those indicated in the operational sections of this specification is not implied.

### NOTES:

- Maximum power dissipation, including output load, must be designed to maintain junction temperature below  $175^\circ\text{C}$  for the ceramic package, and below  $150^\circ\text{C}$  for the plastic packages.
- $\theta_{JA}$  is measured with the component mounted on an evaluation PC board in free air.
- One amplifier may be shorted to ground indefinitely.

## Thermal Information

Thermal Resistance (Typical, Note 2)	$\theta_{JA}$ ( $^\circ\text{C}/\text{W}$ )	$\theta_{JC}$ ( $^\circ\text{C}/\text{W}$ )
CERDIP Package	90	35
PDIP Package	107	N/A
SOIC Package	96	N/A
Maximum Junction Temperature (Ceramic Package, Note 1)	$175^\circ\text{C}$	
Maximum Junction Temperature (Plastic Packages, Note 1)	$150^\circ\text{C}$	
Maximum Storage Temperature Range	$-65^\circ\text{C}$ to $150^\circ\text{C}$	
Maximum Lead Temperature (Soldering 10s)	$300^\circ\text{C}$	
	(SOIC - Lead Tips Only)	

## Electrical Specifications $V_{\text{SUPPLY}} = \pm 15\text{V}$ , Unless Otherwise Specified

PARAMETER	TEST CONDITIONS	TEMP. ( $^\circ\text{C}$ )	HA-4741-2			HA-4741-5			(NOTE 4) HA-4741-9	UNITS
			MIN	TYP	MAX	MIN	TYP	MAX	MAX	
<b>INPUT CHARACTERISTICS</b>										
Offset Voltage		25	-	0.5	3	-	1	5	5	mV
		Full	-	4	5	-	4	6.5	8.5	mV
Average Offset Voltage Drift		Full	-	5	-	-	5	-	-	$\mu\text{V}/^\circ\text{C}$
Bias Current		25	-	60	200	-	60	300	300	nA
		Full	-	-	325	-	-	400	400	nA
Offset Current		25	-	15	30	-	30	50	50	nA
		Full	-	-	75	-	-	100	100	nA
Common Mode Range		Full	$\pm 12$	-	-	$\pm 12$	-	-	-	V
Differential Input Resistance		25	-	0.5	-	-	0.5	-	-	M $\Omega$
Input Voltage Noise	$f = 1\text{kHz}$	25	-	9	-	-	9	-	-	$\text{nV}/\sqrt{\text{Hz}}$
<b>TRANSFER CHARACTERISTICS</b>										
Large Signal Voltage Gain	$V_{\text{OUT}} = \pm 10\text{V}$ , $R_L = 2\text{k}\Omega$	25	50	100	-	25	50	-	-	kV/V
		Full	25	-	-	15	-	-	-	kV/V
Common Mode Rejection Ratio		25	80	95	-	80	95	-	-	dB
		Full	74	-	-	74	-	-	-	dB
Channel Separation (Note 5)		25	66	69	-	66	69	-	-	dB
Small Signal Bandwidth		25	2.5	3.5	-	2.5	3.5	-	-	MHz
<b>OUTPUT CHARACTERISTICS</b>										
Output Voltage Swing	$R_L = 10\text{k}\Omega$	Full	$\pm 12$	$\pm 13.7$	-	$\pm 12$	$\pm 13.7$	-	-	V
Output Voltage Swing	$R_L = 2\text{k}\Omega$	Full	$\pm 10$	$\pm 12.5$	-	$\pm 10$	$\pm 12.5$	-	-	V
Full Power Bandwidth (Notes 6, 7)		25	-	25	-	-	25	-	-	kHz
Output Current	$V_{\text{OUT}} = \pm 10\text{V}$	Full	$\pm 5$	$\pm 15$	-	$\pm 5$	$\pm 15$	-	-	mA
Output Resistance		25	-	300	-	-	300	-	-	$\Omega$
<b>TRANSIENT RESPONSE <math>R_L = 2\text{k}\Omega</math>, <math>C_L = 50\text{pF}</math></b>										
Rise Time	$V_{\text{OUT}} = \pm 200\text{mV}$	25	-	75	140	-	75	140	140	ns
Overshoot		25	-	25	40	-	25	40	40	%

# HA-4741

## Electrical Specifications $V_{SUPPLY} = \pm 15V$ , Unless Otherwise Specified (Continued)

PARAMETER	TEST CONDITIONS	TEMP. (°C)	HA-4741-2			HA-4741-5			(NOTE 4) HA-4741-9	UNITS
			MIN	TYP	MAX	MIN	TYP	MAX	MAX	
Slew Rate	$V_{OUT} = \pm 5V$	25	-	$\pm 1.6$	-	-	$\pm 1.6$	-	-	V/ $\mu$ s
<b>POWER SUPPLY CHARACTERISTICS</b>										
Supply Current		25	-	4.5	5	-	5	7	7	mA
Power Supply Rejection Ratio	$\Delta V_S = \pm 5V$	Full	80	95	-	80	95	-	-	dB

### NOTES:

- Typical and Minimum specifications for the -9 version are the same as those for the -5 version.
- Referred to input;  $f = 10kHz$ ,  $R_S = 1k\Omega$ ,  $V_{IN} = 100mV_{PEAK}$ .
- $V_{OUT} = \pm 10V$ ,  $R_L = 2k\Omega$ .
- Full power bandwidth guaranteed based upon slew rate measurement:  $FPBW = S.R./2\pi V_{PEAK}$ .

## Test Circuit and Waveforms

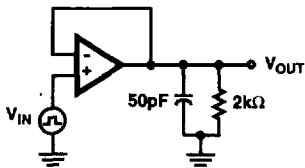
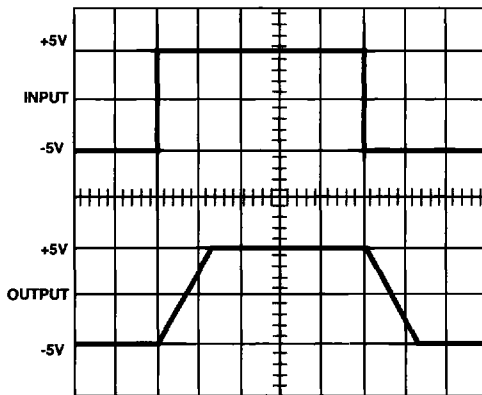
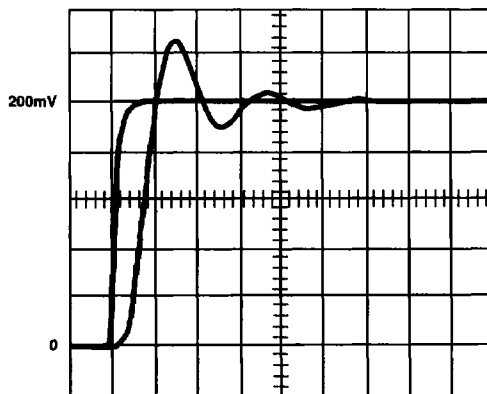

FIGURE 1. SMALL AND LARGE SIGNAL TEST CIRCUIT



Volts = 5V/Div., Time = 5 $\mu$ s/Div.

FIGURE 2. LARGE SIGNAL RESPONSE



Volts = 40mV/Div., Time = 100ns/Div.

FIGURE 3. SMALL SIGNAL RESPONSE

Schematic Diagram

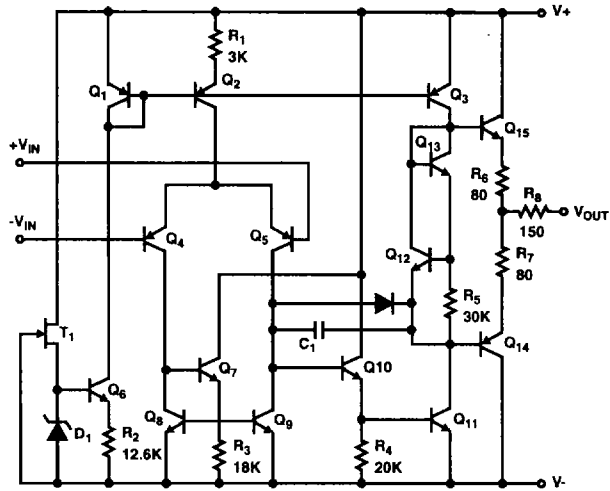

Typical Performance Curves  $V_{SUPPLY} = \pm 15V$ ,  $T_A = 25^\circ C$ , Unless Otherwise Specified

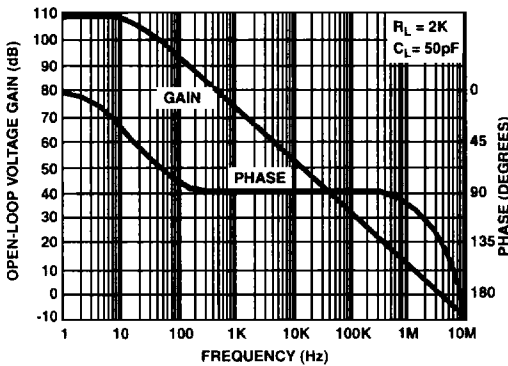

FIGURE 4. OPEN LOOP FREQUENCY RESPONSE

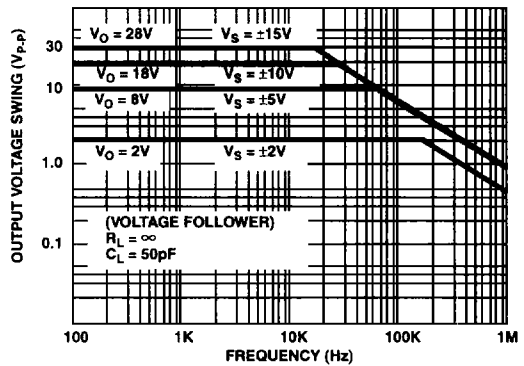

FIGURE 5. OUTPUT VOLTAGE SWING vs FREQUENCY

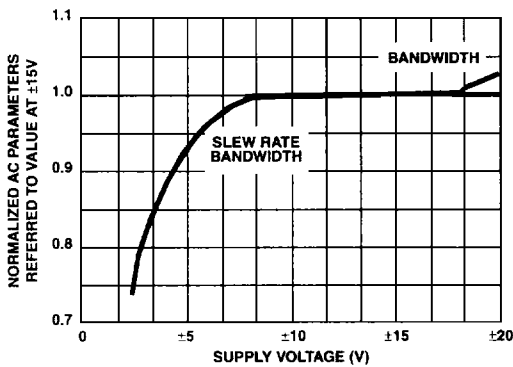

FIGURE 6. NORMALIZED AC PARAMETERS vs SUPPLY VOLTAGE

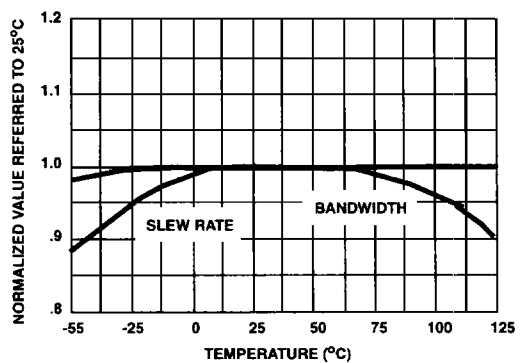

FIGURE 7. NORMALIZED AC PARAMETERS vs TEMPERATURE

**Typical Performance Curves**  $V_{S\text{UPPLY}} = \pm 15\text{V}$ ,  $T_A = 25^\circ\text{C}$ . Unless Otherwise Specified (Continued)

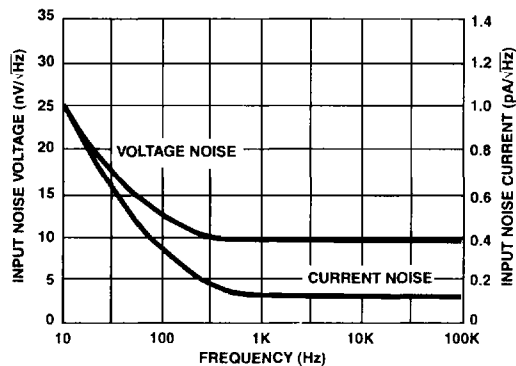

FIGURE 8. INPUT NOISE vs FREQUENCY

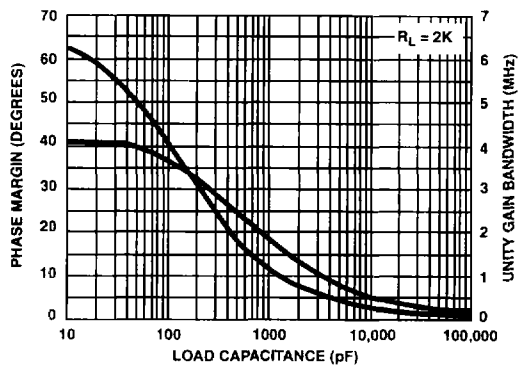

FIGURE 9. SMALL SIGNAL BANDWIDTH AND PHASE MARGIN vs LOAD CAPACITANCE

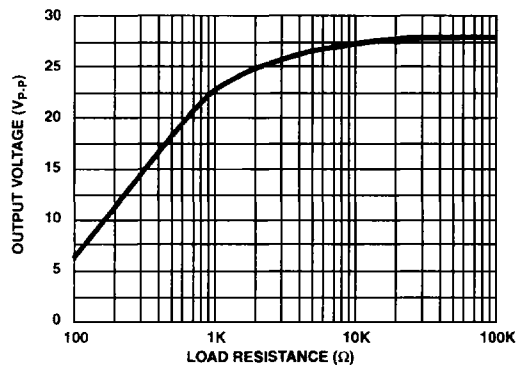

FIGURE 10. MAXIMUM OUTPUT VOLTAGE SWING vs LOAD RESISTANCE

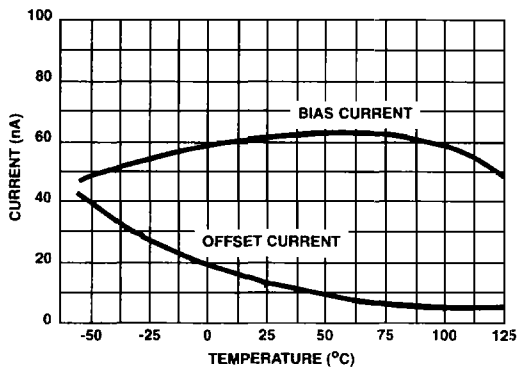

FIGURE 11. INPUT BIAS AND OFFSET CURRENT vs TEMPERATURE

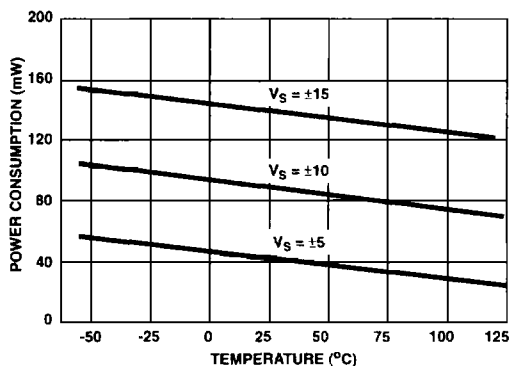

FIGURE 12. POWER CONSUMPTION vs TEMPERATURE

# HA-4741

## Die Characteristics

### DIE DIMENSIONS:

87 mils x 75 mils x 19 mils  
2210 $\mu$ m x 1910 $\mu$ m x 483 $\mu$ m

### METALLIZATION:

Type: Al, 1% Cu  
Thickness: 16k $\text{\AA}$   $\pm$ 2k $\text{\AA}$

### PASSIVATION:

Type: Nitride  
Thickness: 7k $\text{\AA}$   $\pm$ 0.7k $\text{\AA}$

### SUBSTRATE POTENTIAL (Powered Up):

V-

### TRANSISTOR COUNT:

72

### PROCESS:

Junction Isolated Bipolar/JFET

## Metallization Mask Layout

