

## TO-92 Plastic-Encapsulate Transistors

### S9014 TRANSISTOR (NPN)

#### FEATURES

- High Total Power Dissipation. ( $P_C=0.45W$ )
- High  $h_{FE}$  and Good Linearity
- Complementary to S9015

勝特力材料 886-3-5753170  
 勝特力电子(上海) 86-21-34970699  
 勝特力电子(深圳) 86-755-83298787  
[Http://www.100y.com.tw](http://www.100y.com.tw)

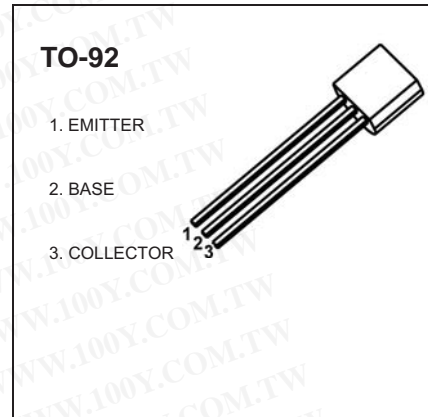

#### MARKING

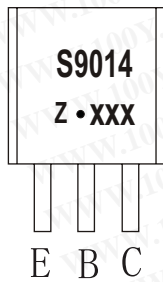

S9014=Device code  
 Solid dot=Green molding compound device,  
 if none,the normal device  
 Z=Rank of  $h_{FE}$ ,  
 XXX=Code

#### Equivalent Circuit

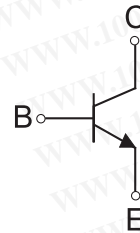

#### ORDERING INFORMATION

Part Number	Package	Packing Method	Pack Quantity
S9014	TO-92	Bulk	1000pcs/Bag
S9014-TA	TO-92	Tape	2000pcs/Box

#### MAXIMUM RATINGS ( $T_a=25^{\circ}C$ unless otherwise noted)

Symbol	Parameter	Value	Unit
$V_{CBO}$	Collector-Base Voltage	50	V
$V_{CEO}$	Collector-Emitter Voltage	45	V
$V_{EBO}$	Emitter-Base Voltage	5	V
$I_C$	Collector Current -Continuous	0.1	A
$P_D$	Collector Power Dissipation	450	mW
$R_{\theta JA}$	Thermal Resistance from Junction to Ambient	277.7	$^{\circ}C / W$
$T_j$	Junction Temperature	150	$^{\circ}C$
$T_{stg}$	Storage Temperature	-55~+150	$^{\circ}C$

## ELECTRICAL CHARACTERISTICS

$T_a=25^\circ\text{C}$  unless otherwise specified

Parameter	Symbol	Test conditions	Min	Typ	Max	Unit
Collector-base breakdown voltage	$V_{(BR)CBO}$	$I_C=100\mu\text{A}$ , $I_E=0$	50			V
Collector-emitter breakdown voltage	$V_{(BR)CEO}$	$I_C=1\text{mA}$ , $I_B=0$	45			V
Emitter-base breakdown voltage	$V_{(BR)EBO}$	$I_E=100\mu\text{A}$ , $I_C=0$	5			V
Collector cut-off current	$I_{CBO}$	$V_{CB}=50\text{V}$ , $I_E=0$			0.1	$\mu\text{A}$
Collector cut-off current	$I_{CEO}$	$V_{CE}=35\text{V}$ , $I_B=0$			1	$\mu\text{A}$
Emitter cut-off current	$I_{EBO}$	$V_{EB}=5\text{V}$ , $I_C=0$			0.1	$\mu\text{A}$
DC current gain	$h_{FE}$	$V_{CE}=5\text{V}$ , $I_C=1\text{mA}$	60		1000	
Collector-emitter saturation voltage	$V_{CE(sat)}$	$I_C=100\text{mA}$ , $I_B=5\text{mA}$			0.3	V
Base-emitter saturation voltage	$V_{BE(sat)}$	$I_C=100\text{mA}$ , $I_B=5\text{mA}$			1	V
Transition frequency	$f_T$	$V_{CE}=5\text{V}$ , $I_C=10\text{mA}$ $f=30\text{MHz}$	150			MHz

### CLASSIFICATION OF $h_{FE(1)}$

Rank	A	B	C	D
Range	60-150	100-300	200-600	400-1000

# Typical Characteristics

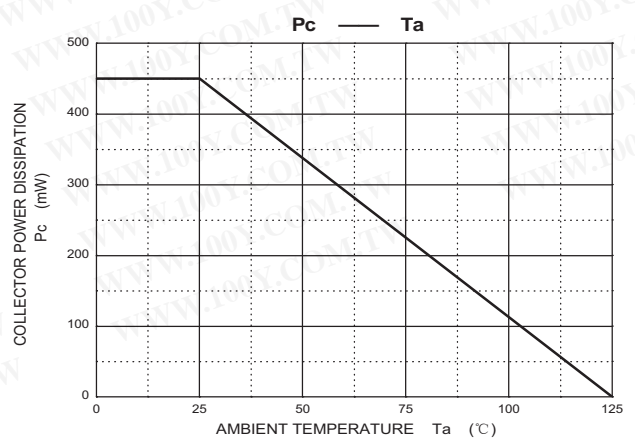
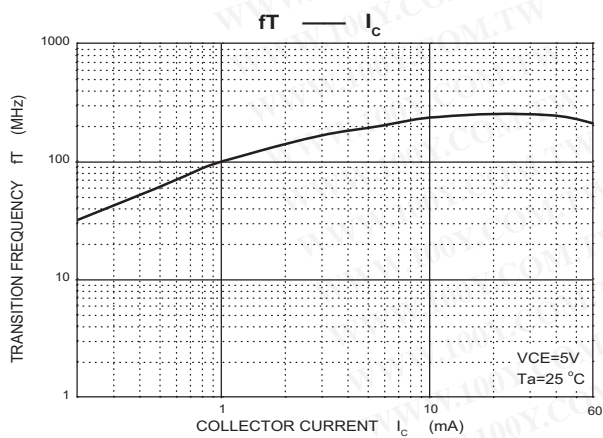
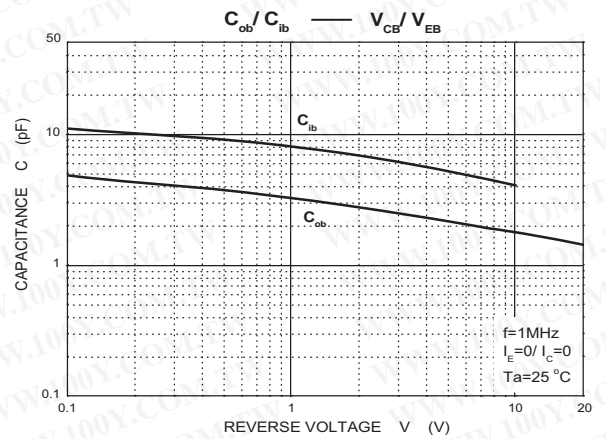
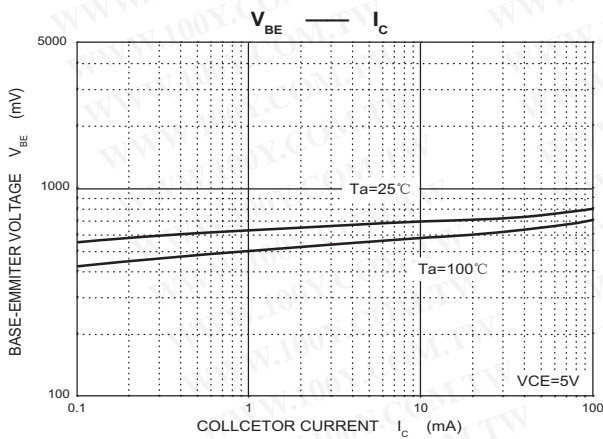
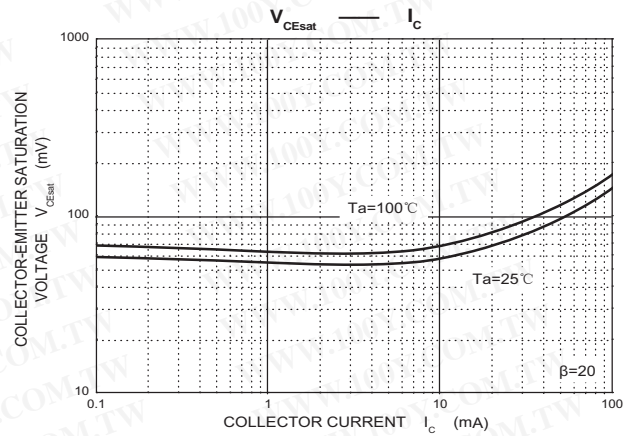
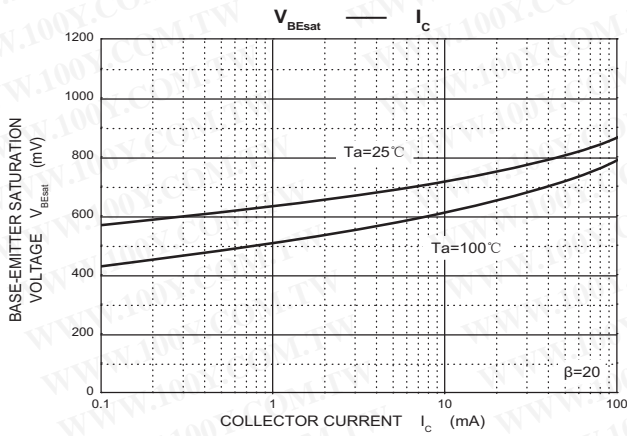
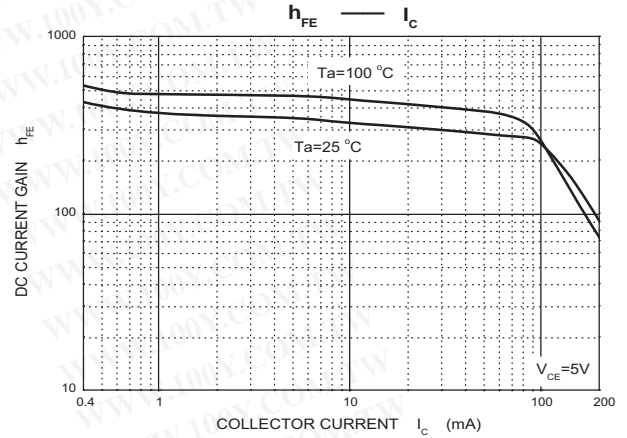
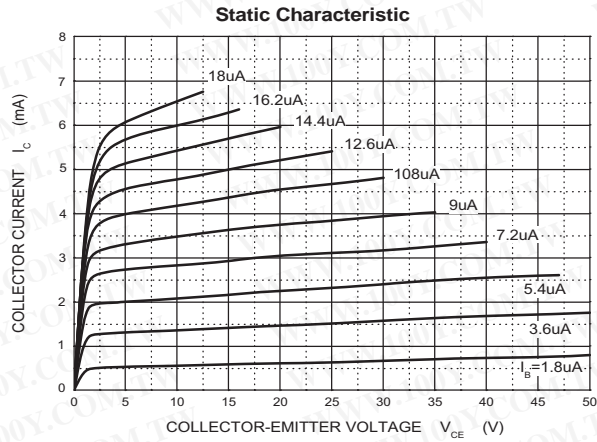

## TO-92 Package Outline Dimensions

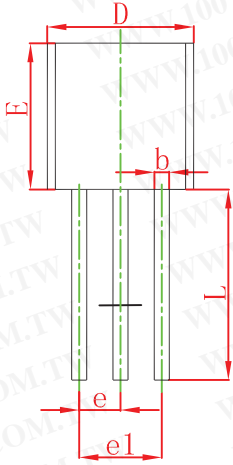
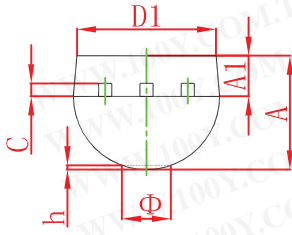

Symbol	Dimensions In Millimeters		Dimensions In Inches	
	Min	Max	Min	Max
A	3.300	3.700	0.130	0.146
A1	1.100	1.400	0.043	0.055
b	0.380	0.550	0.015	0.022
c	0.360	0.510	0.014	0.020
D	4.300	4.700	0.169	0.185
D1	3.430		0.135	
E	4.300	4.700	0.169	0.185
e	1.270 TYP		0.050 TYP	
e1	2.440	2.640	0.096	0.104
L	14.100	14.500	0.555	0.571
Φ		1.600		0.063
h	0.000	0.380	0.000	0.015

## TO-92 Suggested Pad Layout

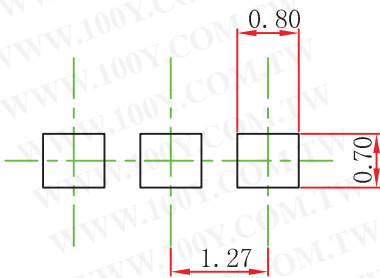

### Note:

1. Controlling dimension: in millimeters.
2. General tolerance:  $\pm 0.05\text{mm}$ .
3. The pad layout is for reference purposes only.

### NOTICE

JCET reserve the right to make modifications, enhancements, improvements, corrections or other changes without further notice to any product herein. JCET does not assume any liability arising out of the application or use of any product described herein.

TO-92 PACKAGE TAPEING DIMENSION

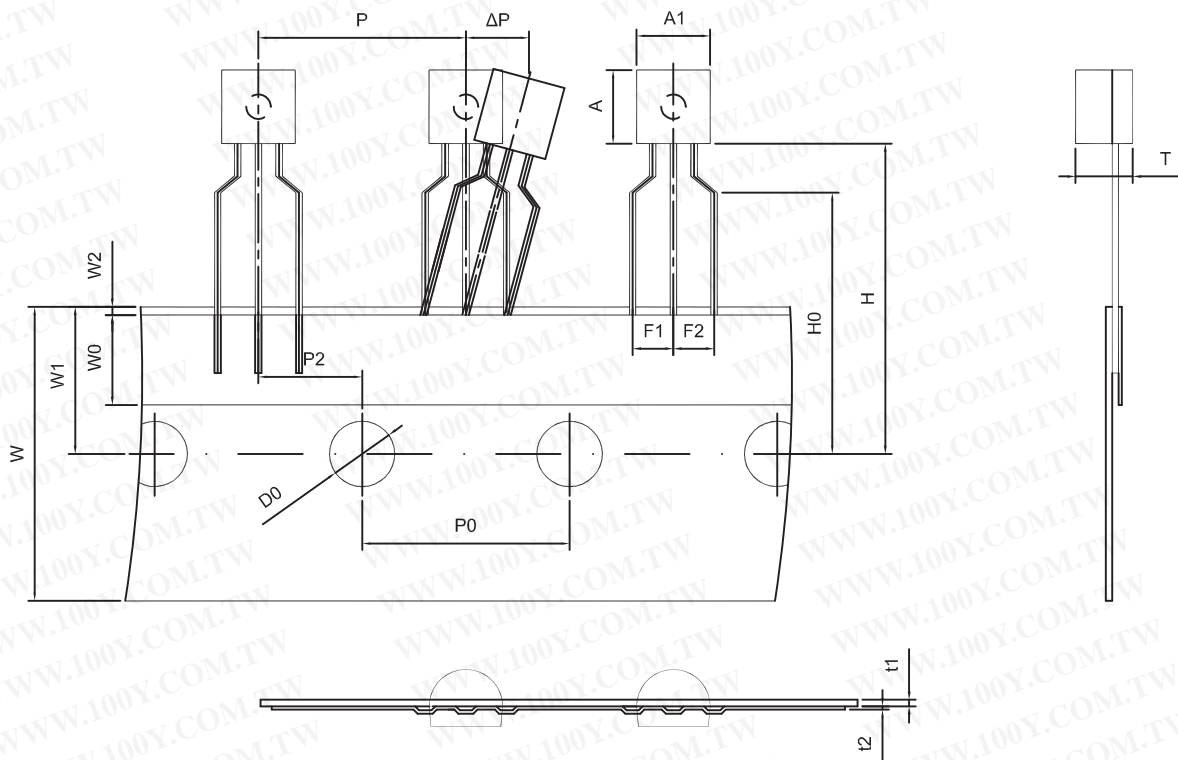

Dimiensions are in millimeter

A1	A	T	P	P0	P2	F1	F2	W
4.5	4.5	3.5	12.7	12.7	6.35	2.5	2.5	18.0
W0	W1	W2	H	H0	D0	t1	t2	ΔP
6.0	9.0	1.0 MAX.	19.0	16.0	4.0	0.4	0.2	0

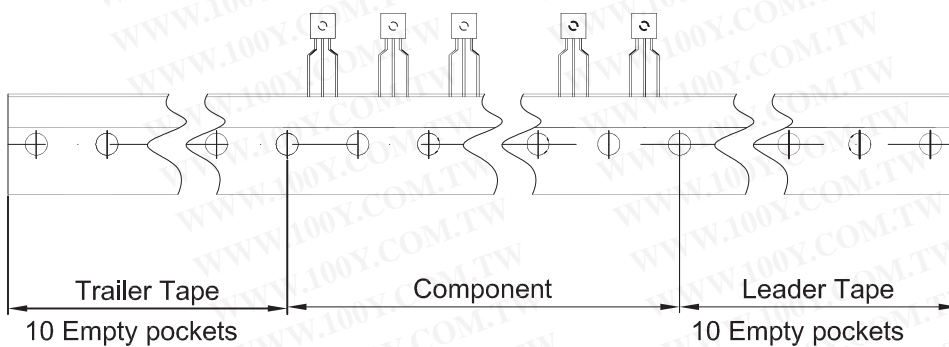

Package	Box	Box Size(mm)	Carton	Carton Size(mm)
TO-92	2000 pcs	333×162×43	20,000 pcs	350×340×250