

勝特力材料 886-3-5753170  
 勝特力电子(上海) 86-21-34970699  
 勝特力电子(深圳) 86-755-83298787  
 Http://www.100y.com.tw

## Power MOSFET

PRODUCT SUMMARY	
$V_{DS}$ (V)	600
$R_{DS(on)}$ ( $\Omega$ )	$V_{GS} = 10\text{ V}$ 0.24
$Q_g$ (Max.) (nC)	150
$Q_{gs}$ (nC)	45
$Q_{gd}$ (nC)	76
Configuration	Single

TO-247AC

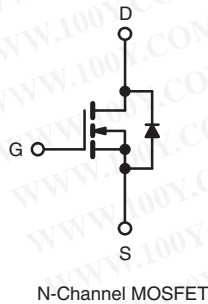
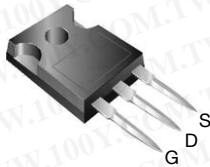

### FEATURES

- Low Gate Charge  $Q_g$  Results in Simple Drive Requirement
- Improved Gate, Avalanche and Dynamic  $dV/dt$  Ruggedness
- Fully Characterized Capacitance and Avalanche Voltage and Current
- Enhanced Body Diode  $dV/dt$  Capability
- Compliant to RoHS Directive 2002/95/EC



Available

**RoHS\***  
COMPLIANT

### BENEFITS

- Hard Switching Primary or PFS Switch
- Switch Mode Power Supply (SMPS)
- Uninterruptible Power Supply
- High Speed Power Switching
- Motor Drive

ORDERING INFORMATION	
Package	TO-247AC
Lead (Pb)-free	IRFP22N60KPbF
	SiHFP22N60K-E3
SnPb	IRFP22N60K
	SiHFP22N60K

ABSOLUTE MAXIMUM RATINGS ( $T_C = 25\text{ }^\circ\text{C}$ , unless otherwise noted)			
PARAMETER	SYMBOL	LIMIT	UNIT
Drain-Source Voltage	$V_{DS}$	600	V
Gate-Source Voltage	$V_{GS}$	$\pm 30$	
Continuous Drain Current	$V_{GS}$ at 10 V	$T_C = 25\text{ }^\circ\text{C}$	22
		$T_C = 100\text{ }^\circ\text{C}$	14
Pulsed Drain Current <sup>a</sup>	$I_{DM}$	88	A
Linear Derating Factor		2.9	W/ $^\circ\text{C}$
Single Pulse Avalanche Energy <sup>b</sup>	$E_{AS}$	380	mJ
Repetitive Avalanche Current <sup>a</sup>	$I_{AR}$	22	A
Repetitive Avalanche Energy <sup>a</sup>	$E_{AR}$	37	mJ
Maximum Power Dissipation	$T_C = 25\text{ }^\circ\text{C}$	$P_D$	370
Peak Diode Recovery $dV/dt^c$		$dV/dt$	15
Operating Junction and Storage Temperature Range	$T_J, T_{stg}$	- 55 to + 150	$^\circ\text{C}$
Soldering Recommendations (Peak Temperature)	for 10 s	300 <sup>d</sup>	

#### Notes

- Repetitive rating; pulse width limited by maximum junction temperature (see fig. 11).
- Starting  $T_J = 25\text{ }^\circ\text{C}$ ,  $L = 1.5\text{ mH}$ ,  $R_g = 25\text{ }\Omega$ ,  $I_{AS} = 22\text{ A}$  (see fig. 12).
- $I_{SD} \leq 22\text{ A}$ ,  $dI/dt \leq 360\text{ A}/\mu\text{s}$ ,  $V_{DD} \leq V_{DS}$ ,  $T_J \leq 150\text{ }^\circ\text{C}$ .
- 1.6 mm from case.

\* Pb containing terminations are not RoHS compliant, exemptions may apply

# IRFP22N60K, SiHFP22N60K



Vishay Siliconix

THERMAL RESISTANCE RATINGS				
PARAMETER	SYMBOL	TYP.	MAX.	UNIT
Maximum Junction-to-Ambient	$R_{thJA}$	-	40	°C/W
Case-to-Sink, Flat, Greased Surface	$R_{thCS}$	0.24	-	
Maximum Junction-to-Case (Drain)	$R_{thJC}$	-	0.34	

## SPECIFICATIONS ( $T_J = 25\text{ }^\circ\text{C}$ , unless otherwise noted)

PARAMETER	SYMBOL	TEST CONDITIONS	MIN.	TYP.	MAX.	UNIT
<b>Static</b>						
Drain-Source Breakdown Voltage	$V_{DS}$	$V_{GS} = 0\text{ V}$ , $I_D = 250\text{ }\mu\text{A}$	600	-	-	V
$V_{DS}$ Temperature Coefficient	$\Delta V_{DS}/T_J$	Reference to $25\text{ }^\circ\text{C}$ , $I_D = 1\text{ mA}^d$	-	0.30	-	V/°C
Gate-Source Threshold Voltage	$V_{GS(th)}$	$V_{DS} = V_{GS}$ , $I_D = 250\text{ }\mu\text{A}$	3.0	-	5.0	V
Gate-Source Leakage	$I_{GSS}$	$V_{GS} = \pm 30\text{ V}$	-	-	$\pm 100$	nA
Zero Gate Voltage Drain Current	$I_{DSS}$	$V_{DS} = 600\text{ V}$ , $V_{GS} = 0\text{ V}$	-	-	50	$\mu\text{A}$
		$V_{DS} = 480\text{ V}$ , $V_{GS} = 0\text{ V}$ , $T_J = 125\text{ }^\circ\text{C}$	-	-	250	
Drain-Source On-State Resistance	$R_{DS(on)}$	$V_{GS} = 10\text{ V}$ , $I_D = 13\text{ A}^b$	-	0.240	0.280	$\Omega$
Forward Transconductance	$g_{fs}$	$V_{DS} = 50\text{ V}$ , $I_D = 13\text{ A}^b$	11	-	-	S
<b>Dynamic</b>						
Input Capacitance	$C_{iss}$	$V_{GS} = 0\text{ V}$ , $V_{DS} = 25\text{ V}$ , $f = 1.0\text{ MHz}$ , see fig. 5	-	3570	-	pF
Output Capacitance	$C_{oss}$		-	350	-	
Reverse Transfer Capacitance	$C_{rss}$		-	36	-	
Output Capacitance	$C_{oss}$	$V_{GS} = 0\text{ V}$	$V_{DS} = 1.0\text{ V}$ , $f = 1.0\text{ MHz}$	-	4710	-
			$V_{DS} = 480\text{ V}$ , $f = 1.0\text{ MHz}$	-	92	-
Effective Output Capacitance	$C_{oss\text{ eff.}}$	$V_{DS} = 0\text{ V to }480\text{ V}$	-	180	-	
Total Gate Charge	$Q_g$	$V_{GS} = 10\text{ V}$ , $I_D = 22\text{ A}$ , $V_{DS} = 480\text{ V}$ see fig. 6 and 13 <sup>b</sup>	-	-	150	nC
Gate-Source Charge	$Q_{gs}$		-	-	45	
Gate-Drain Charge	$Q_{gd}$		-	-	76	
Turn-On Delay Time	$t_{d(on)}$	$V_{DD} = 300\text{ V}$ , $I_D = 22\text{ A}$ , $R_g = 6.2$ , $V_{GS} = 10\text{ V}$ , see fig. 10 <sup>b</sup>	-	26	-	ns
Rise Time	$t_r$		-	99	-	
Turn-Off Delay Time	$t_{d(off)}$		-	48	-	
Fall Time	$t_f$		-	37	-	
<b>Drain-Source Body Diode Characteristics</b>						
Continuous Source-Drain Diode Current	$I_S$	MOSFET symbol showing the integral reverse p - n junction diode 	-	-	22	A
Pulsed Diode Forward Current <sup>a</sup>	$I_{SM}$		-	-	88	
Body Diode Voltage	$V_{SD}$	$T_J = 25\text{ }^\circ\text{C}$ , $I_S = 22\text{ A}$ , $V_{GS} = 0\text{ V}^b$	-	-	1.5	V
Body Diode Reverse Recovery Time	$t_{rr}$	$T_J = 25\text{ }^\circ\text{C}$	-	590	890	ns
		$T_J = 125\text{ }^\circ\text{C}$	-	670	1010	
Body Diode Reverse Recovery Charge	$Q_{rr}$	$T_J = 25\text{ }^\circ\text{C}$	-	7.2	11	$\mu\text{C}$
		$T_J = 125\text{ }^\circ\text{C}$	-	8.5	13	
Reverse Recovery Current	$I_{RRM}$	$T_J = 25\text{ }^\circ\text{C}$	-	26	39	
Forward Turn-On Time	$t_{on}$	Intrinsic turn-on time is negligible (turn-on is dominated by $L_S$ and $L_D$ )				

### Notes

- Repetitive rating; pulse width limited by maximum junction temperature (see fig. 11).
- Pulse width  $\leq 300\text{ }\mu\text{s}$ ; duty cycle  $\leq 2\%$ .
- $C_{oss\text{ eff.}}$  is a fixed capacitance that gives the same charging time as  $C_{oss}$  while  $V_{DS}$  is rising from 0 % to 80 %  $V_{DS}$ .

## TYPICAL CHARACTERISTICS (25 °C, unless otherwise noted)

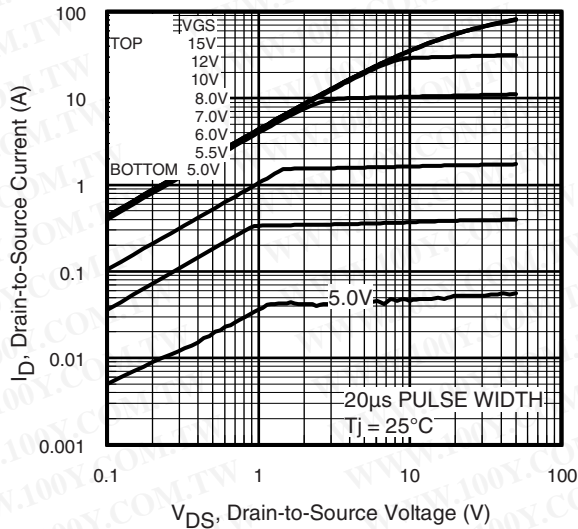

Fig. 1 - Typical Output Characteristics

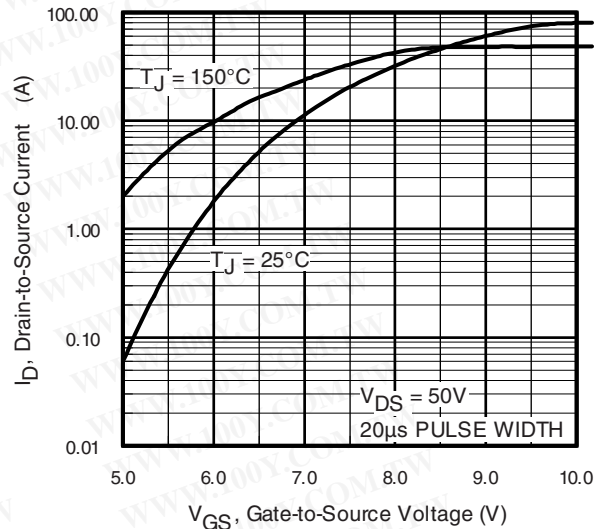

Fig. 3 - Typical Transfer Characteristics

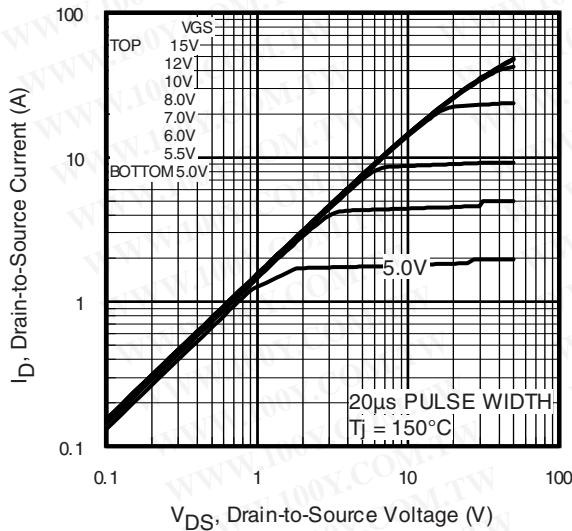

Fig. 2 - Typical Output Characteristics

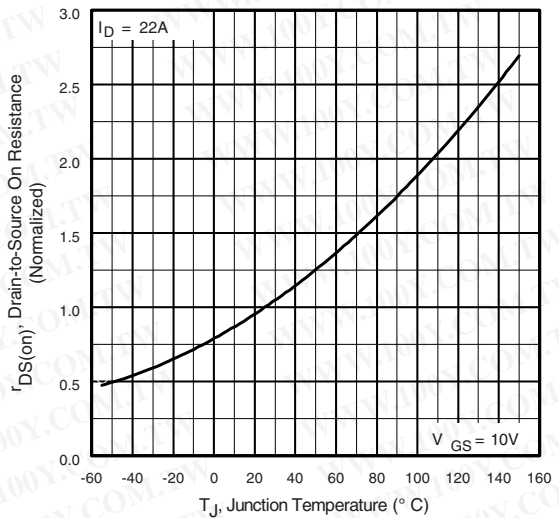

Fig. 4 - Normalized On-Resistance vs. Temperature

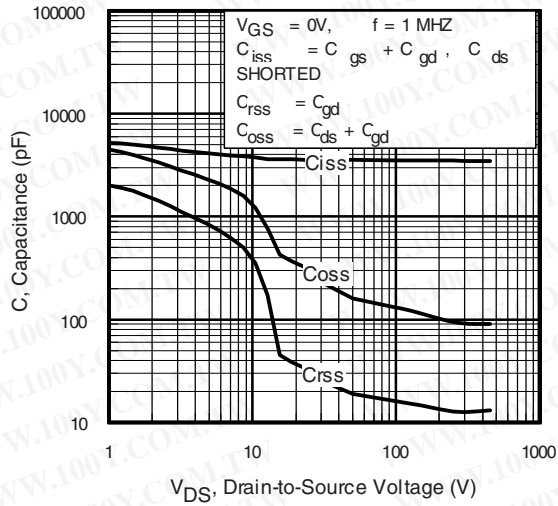

Fig. 5 - Typical Capacitance vs. Drain-to-Source Voltage

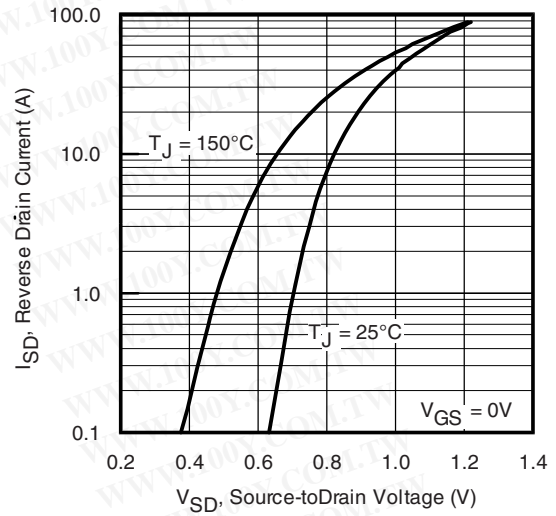

Fig. 7 - Typical Source-Drain Diode Forward Voltage

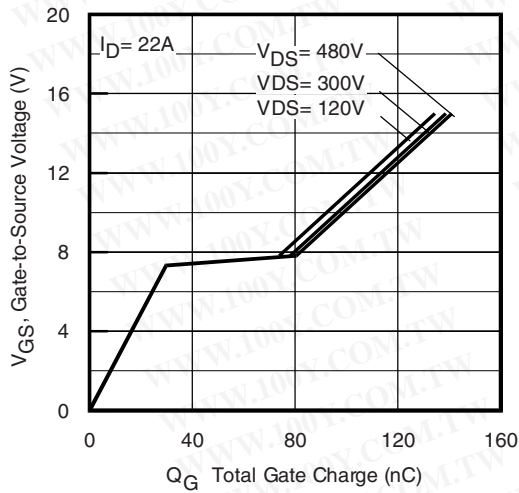

Fig. 6 - Typical Gate Charge vs. Gate-to-Source Voltage

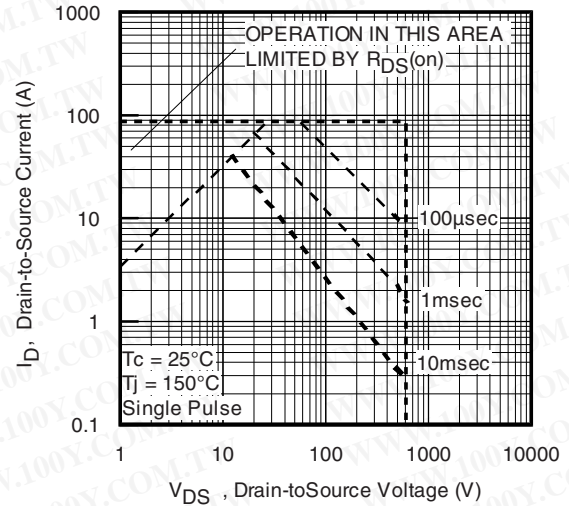
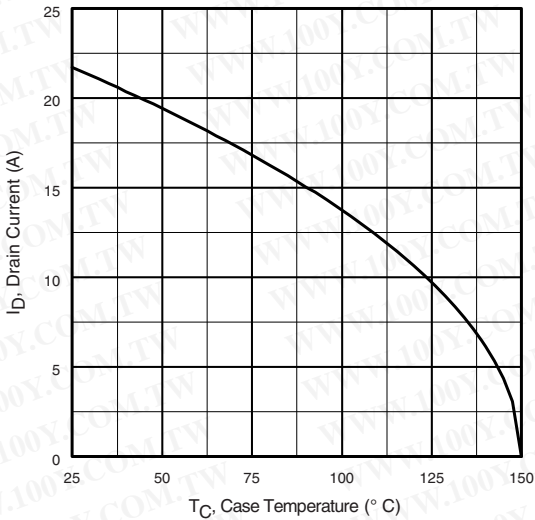
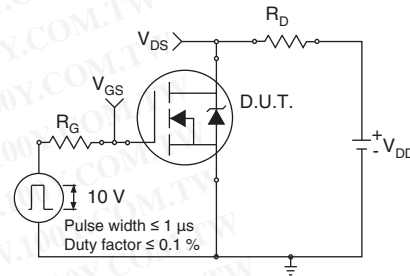

Fig. 8 - Maximum Safe Operating Area



**Fig. 9 - Maximum Drain Current vs. Case Temperature**



**Fig. 10a - Switching Time Test Circuit**

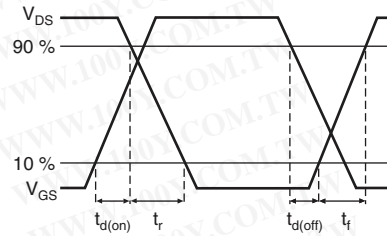

**Fig. 10b - Switching Time Waveforms**

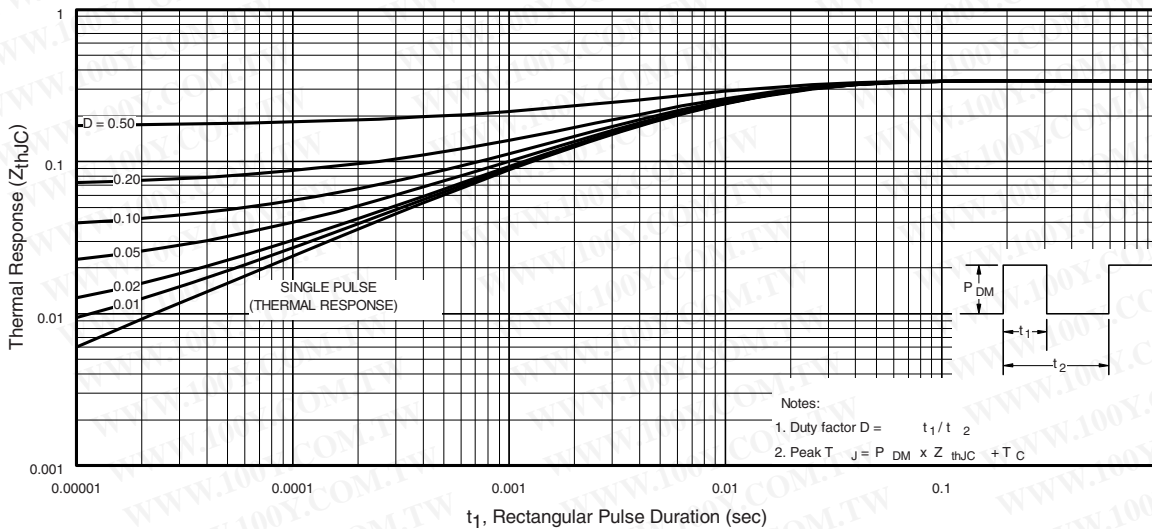

**Fig. 11 - Maximum Effective Transient Thermal Impedance, Junction-to-Case**

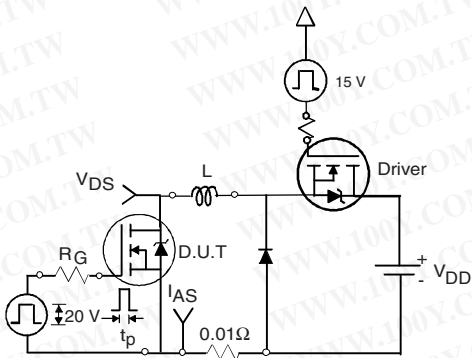

Fig. 12a - Unclamped Inductive Test Circuit

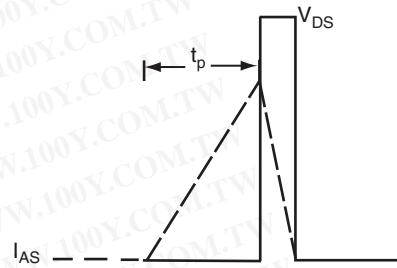

Fig. 12b - Unclamped Inductive Waveforms

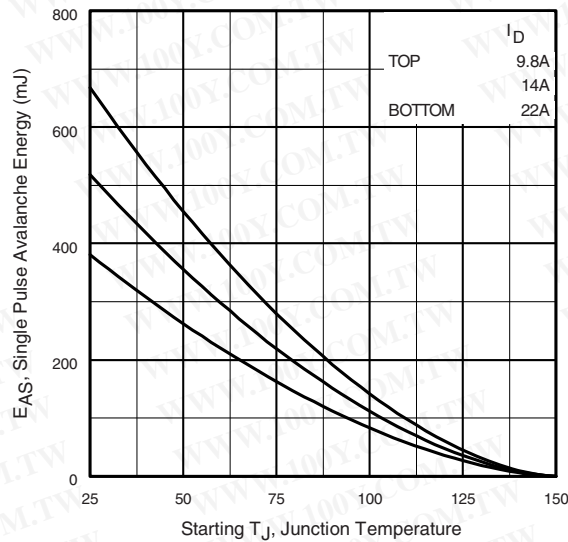

Fig. 12c - Maximum Avalanche Energy vs. Drain Current

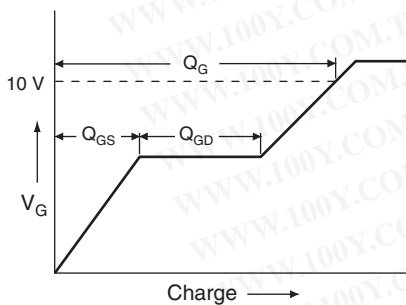

Fig. 13a - Basic Gate Charge Waveform

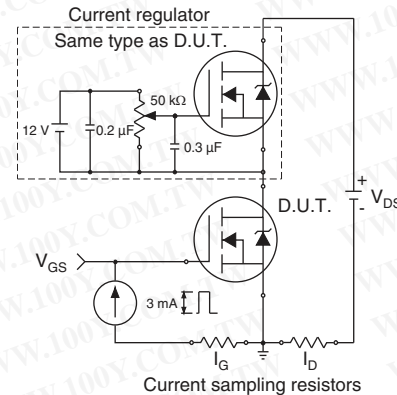
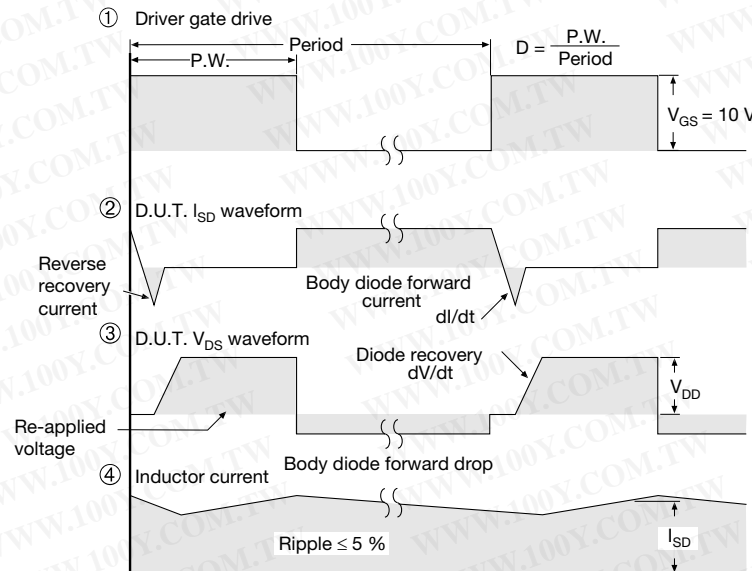
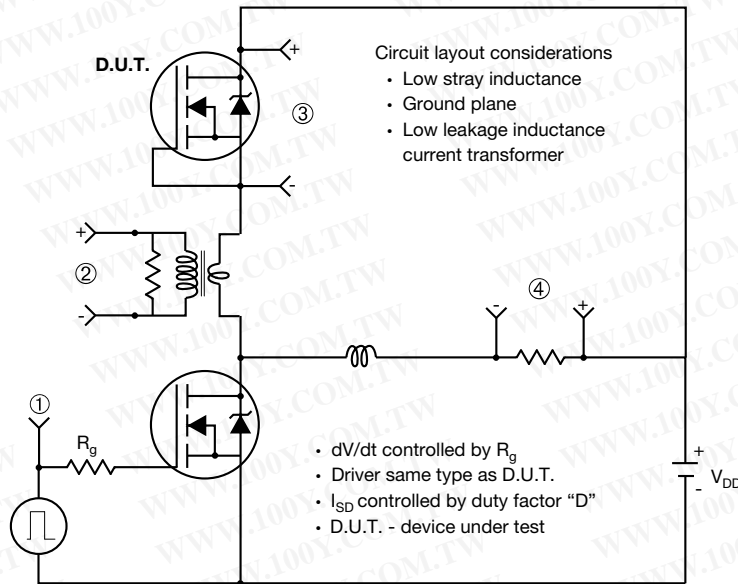

Fig. 13b - Gate Charge Test Circuit

### Peak Diode Recovery dV/dt Test Circuit



**Note**  
a.  $V_{GS} = 5\text{ V}$  for logic level devices

**Fig. 14 - For N-Channel**

Vishay Siliconix maintains worldwide manufacturing capability. Products may be manufactured at one of several qualified locations. Reliability data for Silicon Technology and Package Reliability represent a composite of all qualified locations. For related documents such as package/tape drawings, part marking, and reliability data, see [www.vishay.com/ppg?91208](http://www.vishay.com/ppg?91208).



**TO-247AC (HIGH VOLTAGE)**

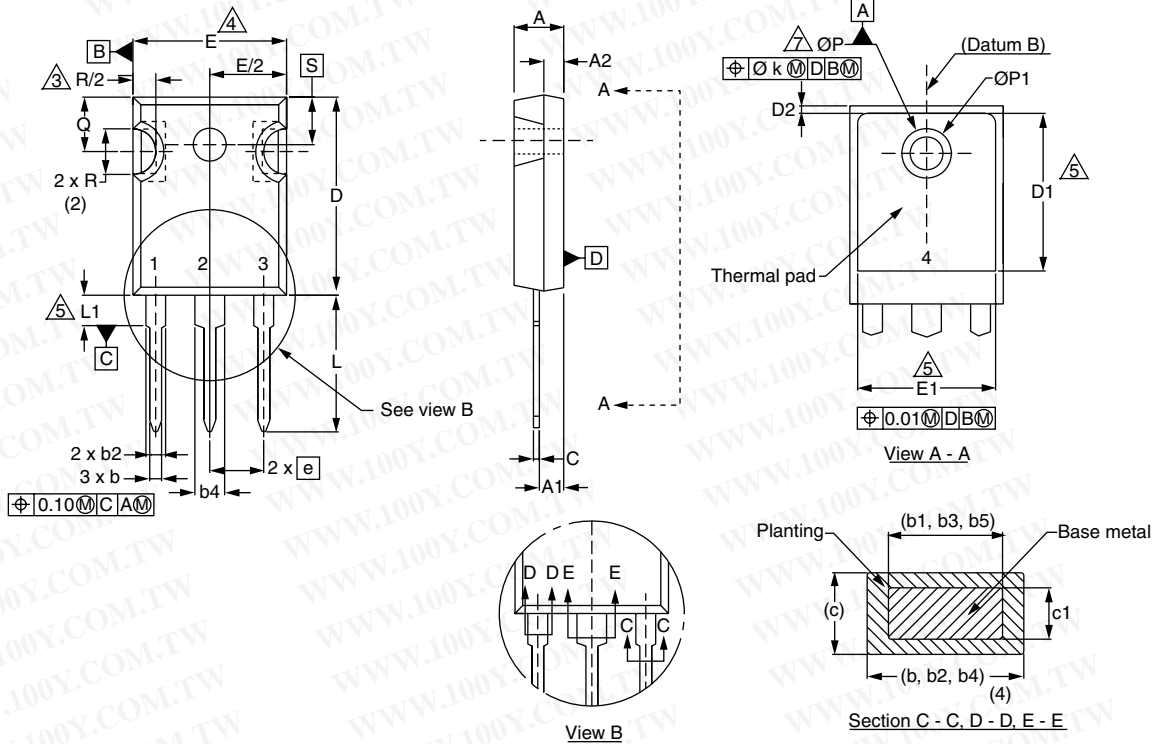

DIM.	MILLIMETERS		INCHES	
	MIN.	MAX.	MIN.	MAX.
A	4.65	5.31	0.183	0.209
A1	2.21	2.59	0.087	0.102
A2	1.50	2.49	0.059	0.098
b	0.99	1.40	0.039	0.055
b1	0.99	1.35	0.039	0.053
b2	1.65	2.39	0.065	0.094
b3	1.65	2.37	0.065	0.093
b4	2.59	3.43	0.102	0.135
b5	2.59	3.38	0.102	0.133
c	0.38	0.86	0.015	0.034
c1	0.38	0.76	0.015	0.030
D	19.71	20.70	0.776	0.815
D1	13.08	-	0.515	-

DIM.	MILLIMETERS		INCHES	
	MIN.	MAX.	MIN.	MAX.
D2	0.51	1.30	0.020	0.051
E	15.29	15.87	0.602	0.625
E1	13.72	-	0.540	-
e	5.46 BSC		0.215 BSC	
$\phi k$	0.254		0.010	
L	14.20	16.10	0.559	0.634
L1	3.71	4.29	0.146	0.169
N	7.62 BSC		0.300 BSC	
$\phi P$	3.56	3.66	0.140	0.144
$\phi P1$	-	7.39	-	0.291
Q	5.31	5.69	0.209	0.224
R	4.52	5.49	0.178	0.216
S	5.51 BSC		0.217 BSC	

ECN: S-81920-Rev. A, 15-Sep-08  
DWG: 5971

**Notes**

1. Dimensioning and tolerancing per ASME Y14.5M-1994.
2. Contour of slot optional.
3. Dimension D and E do not include mold flash. Mold flash shall not exceed 0.127 mm (0.005") per side. These dimensions are measured at the outermost extremes of the plastic body.
4. Thermal pad contour optional with dimensions D1 and E1.
5. Lead finish uncontrolled in L1.
6.  $\phi P$  to have a maximum draft angle of 1.5 to the top of the part with a maximum hole diameter of 3.91 mm (0.154").
7. Outline conforms to JEDEC outline TO-247 with exception of dimension c.



勝特力材料 886-3-5753170  
勝特力电子(上海) 86-21-34970699  
勝特力电子(深圳) 86-755-83298787  
[Http://www.100y.com.tw](http://www.100y.com.tw)

## Disclaimer

ALL PRODUCT, PRODUCT SPECIFICATIONS AND DATA ARE SUBJECT TO CHANGE WITHOUT NOTICE TO IMPROVE RELIABILITY, FUNCTION OR DESIGN OR OTHERWISE.

Vishay Intertechnology, Inc., its affiliates, agents, and employees, and all persons acting on its or their behalf (collectively, "Vishay"), disclaim any and all liability for any errors, inaccuracies or incompleteness contained in any datasheet or in any other disclosure relating to any product.

Vishay makes no warranty, representation or guarantee regarding the suitability of the products for any particular purpose or the continuing production of any product. To the maximum extent permitted by applicable law, Vishay disclaims (i) any and all liability arising out of the application or use of any product, (ii) any and all liability, including without limitation special, consequential or incidental damages, and (iii) any and all implied warranties, including warranties of fitness for particular purpose, non-infringement and merchantability.

Statements regarding the suitability of products for certain types of applications are based on Vishay's knowledge of typical requirements that are often placed on Vishay products in generic applications. Such statements are not binding statements about the suitability of products for a particular application. It is the customer's responsibility to validate that a particular product with the properties described in the product specification is suitable for use in a particular application. Parameters provided in datasheets and/or specifications may vary in different applications and performance may vary over time. All operating parameters, including typical parameters, must be validated for each customer application by the customer's technical experts. Product specifications do not expand or otherwise modify Vishay's terms and conditions of purchase, including but not limited to the warranty expressed therein.

Except as expressly indicated in writing, Vishay products are not designed for use in medical, life-saving, or life-sustaining applications or for any other application in which the failure of the Vishay product could result in personal injury or death. Customers using or selling Vishay products not expressly indicated for use in such applications do so at their own risk and agree to fully indemnify and hold Vishay and its distributors harmless from and against any and all claims, liabilities, expenses and damages arising or resulting in connection with such use or sale, including attorneys fees, even if such claim alleges that Vishay or its distributor was negligent regarding the design or manufacture of the part. Please contact authorized Vishay personnel to obtain written terms and conditions regarding products designed for such applications.

No license, express or implied, by estoppel or otherwise, to any intellectual property rights is granted by this document or by any conduct of Vishay. Product names and markings noted herein may be trademarks of their respective owners.