



# TN12, TS12 and TYNx12 Series

Sensitive and Standard

12 A SCRS

## Main features

Symbol	Value	Unit
$I_{T(RMS)}$	12	A
$V_{DRM}/V_{RRM}$	600 to 1000	V
$I_{GT}$	0.2 to 15	mA

## Description

Available either in sensitive (TS12) or standard (TN12 / TYN) gate triggering levels, the 12 A SCR series is suitable to fit all modes of control, found in applications such as overvoltage crowbar protection, motor control circuits in power tools and kitchen aids, inrush current limiting circuits, capacitive discharge ignition and voltage regulation circuits.

Available in through-hole or surface-mount packages, they provide an optimized performance in a limited space area.

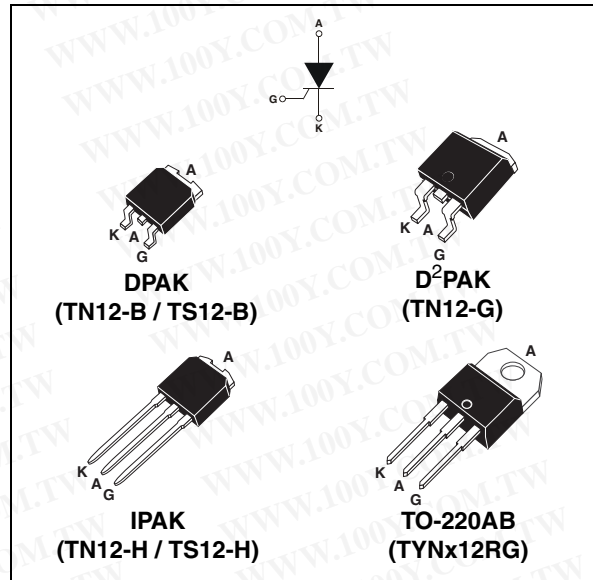

## Order codes

Part Numbers	Marking
TN1215-x00B	TN1215x00
TN1215-x00B-TR	TN1215x00
TN1215-x00G	TN1215x00G
TN1215-x00G-TR	TN1215x00G
TN1215-x00H	TN1215x00
TS1220-x00B	TS1220x00
TS1220-x00B-TR	TS1220x00
TS1220-x00H	TS1220x00
TYNx12RG	TYNx12
TYNx12TRG	TYNx12T

# 1 Characteristics

勝特力材料 886-3-5753170  
 勝特力电子(上海) 86-21-34970699  
 勝特力电子(深圳) 86-755-83298787  
[Http://www.100y.com.tw](http://www.100y.com.tw)

**Table 1. Absolute ratings (limiting values)**

Symbol	Parameter		Value		Unit	
			TN12-G TYN12	TN12-B/H TS12-B/H		
$I_{T(RMS)}$	RMS on-state current (180° conduction angle)		$T_c = 105^\circ C$	12	A	
$I_{T(AV)}$	Average on-state current (180° conduction angle)		$T_c = 105^\circ C$	8	A	
$I_{TSM}$	Non repetitive surge peak on-state current	$t_p = 8.3 \text{ ms}$	$T_j = 25^\circ C$	145	115	A
		$t_p = 10 \text{ ms}$		140	110	
$I^2t$	$I^2t$ Value for fusing	$t_p = 10 \text{ ms}$	$T_j = 25^\circ C$	98	60	$A^2s$
dl/dt	Critical rate of rise of on-state current $I_G = 2 \times I_{GT}$ , $t_r \leq 100 \text{ ns}$	F = 60 Hz	$T_j = 125^\circ C$	50		A/ $\mu s$
$I_{GM}$	Peak gate current	$t_p = 20 \mu s$	$T_j = 125^\circ C$	4		A
$P_{G(AV)}$	Average gate power dissipation		$T_j = 125^\circ C$	1		W
$T_{stg}$ $T_j$	Storage junction temperature range Operating junction temperature range			- 40 to + 150 - 40 to + 125		$^\circ C$
$V_{RGM}$	Maximum peak reverse gate voltage (for TN12 and TYN12 only)			5		V

**Table 2. Sensitive electrical characteristics ( $T_j = 25^\circ C$ , unless otherwise specified)**

Symbol	Test Conditions			TS1220	Unit	
$I_{GT}$	$V_D = 12 \text{ V}$ $R_L = 140 \Omega$			MAX.	200	$\mu A$
$V_{GT}$				MAX.	0.8	V
$V_{GD}$	$V_D = V_{DRM}$ $R_L = 3.3 \text{ k}\Omega$ $R_{GK} = 220 \Omega$	$T_j = 125^\circ C$		MIN.	0.1	V
$V_{RG}$	$I_{RG} = 10 \mu A$			MIN.	8	V
$I_H$	$I_T = 50 \text{ mA}$ $R_{GK} = 1 \text{ k}\Omega$			MAX.	5	mA
$I_L$	$I_G = 1 \text{ mA}$ $R_{GK} = 1 \text{ k}\Omega$			MAX.	6	mA
dV/dt	$V_D = 65 \% V_{DRM}$ $R_{GK} = 220 \Omega$	$T_j = 125^\circ C$		MIN.	5	V/ $\mu s$
$V_{TM}$	$I_{TM} = 24 \text{ A}$ $t_p = 380 \mu s$	$T_j = 25^\circ C$		MAX.	1.6	V
$V_{t0}$	Threshold voltage	$T_j = 125^\circ C$		MAX.	0.85	V
$R_d$	Dynamic resistance	$T_j = 125^\circ C$		MAX.	30	$m\Omega$
$I_{DRM}$ $I_{RRM}$	$V_{DRM} = V_{RRM}$ $R_{GK} = 220 \Omega$	$T_j = 25^\circ C$		MAX.	5	$\mu A$
		$T_j = 125^\circ C$			2	mA



**Table 3. Standard electrical characteristics ( $T_j = 25^\circ\text{C}$ , unless otherwise specified)**

Symbol	Test Conditions		TN1215		TYN		Unit		
			B / H	G	x12T	x12			
$I_{GT}$	$V_D = 12\text{ V}$	$R_L = 33\ \Omega$	MIN.	2	0.5	2	mA		
			MAX.	15	5	15			
$V_{GT}$			MAX.	1.3			V		
$V_{GD}$	$V_D = V_{DRM}$	$R_L = 3.3\ \text{k}\Omega$	$T_j = 125^\circ\text{C}$	MIN.	0.2		V		
$I_H$	$I_T = 500\ \text{mA}$	Gate open		MAX.	40	30	15	30	mA
$I_L$	$I_G = 1.2 I_{GT}$			MAX.	80	60	30	60	mA
dV/dt	$V_D = 67\% V_{DRM}$	Gate open	$T_j = 125^\circ\text{C}$	MIN.	200	40	200	V/ $\mu\text{s}$	
$V_{TM}$	$I_{TM} = 24\ \text{A}$	$t_p = 380\ \mu\text{s}$	$T_j = 25^\circ\text{C}$	MAX.	1.6			V	
$V_{t0}$	Threshold voltage		$T_j = 125^\circ\text{C}$	MAX.	0.85			V	
$R_d$	Dynamic resistance		$T_j = 125^\circ\text{C}$	MAX.	30			m $\Omega$	
$I_{DRM}$	$V_{DRM} = V_{RRM}$		$T_j = 25^\circ\text{C}$	MAX.	5			$\mu\text{A}$	
$I_{RRM}$			$T_j = 125^\circ\text{C}$		2			mA	

**Table 4. Thermal resistance**

Symbol	Parameter		Value	Unit	
$R_{th(j-c)}$	Junction to case (DC)		1.3	$^\circ\text{C/W}$	
$R_{th(j-a)}$	Junction to ambient (DC)	$S^{(1)} = 0.5\ \text{cm}^2$	DPAK	70	$^\circ\text{C/W}$
		$S^{(1)} = 1\ \text{cm}^2$	D <sup>2</sup> PAK	45	
			IPAK	100	
			TO-220AB	60	

1. S = Copper surface under tab

**Figure 1. Maximum average power dissipation versus average on-state current**

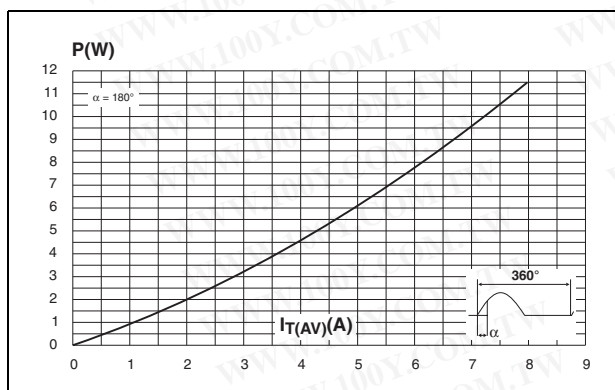

**Figure 2. Average and D.C. on-state current versus case temperature**

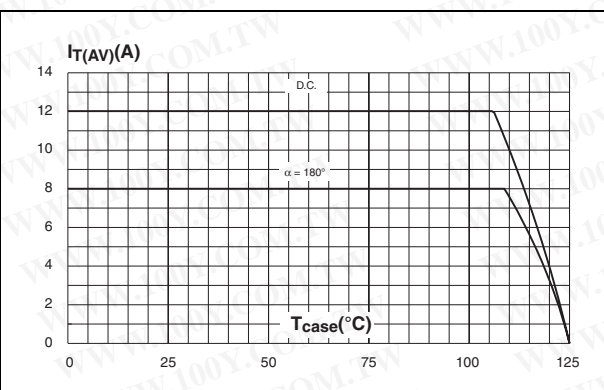

Figure 3. Average and D.C. on-state current versus ambient temperature (device mounted on FR4 with recommended pad layout) (DPAK)

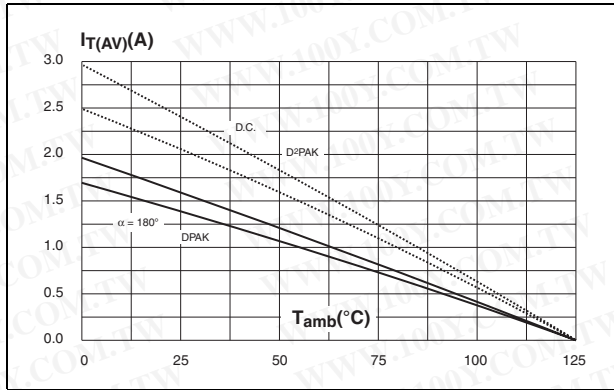

Figure 4. Relative variation of thermal impedance junction to case versus pulse duration

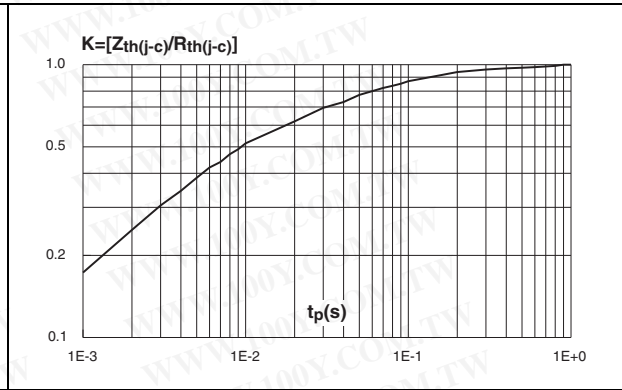

Figure 5. Relative variation of thermal impedance junction to ambient versus pulse duration (recommended pad layout, FR4 PC board for DPAK)

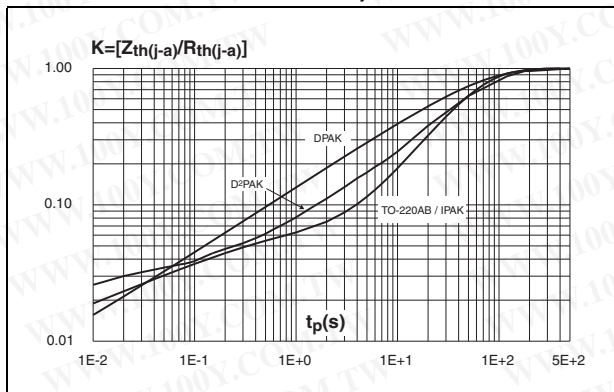

Figure 6. Relative variation of gate trigger current and holding current versus junction temperature for TS12 series

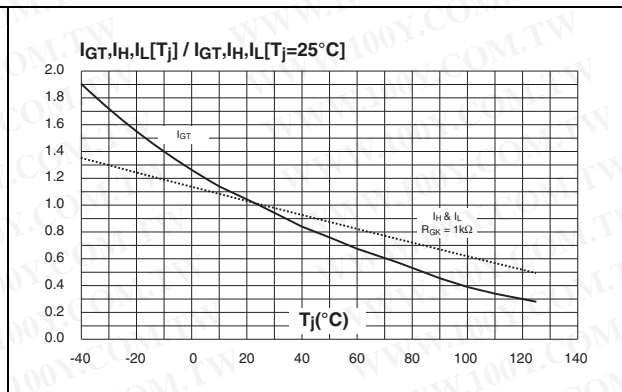

Figure 7. Relative variation of gate trigger current and holding current versus junction temperature for TN12 and TYNx12 series

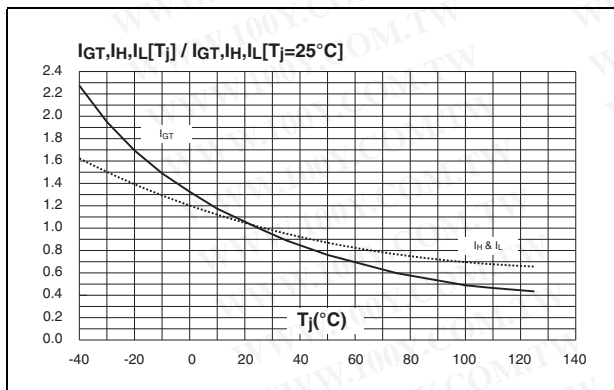

Figure 8. Relative variation of holding current versus gate-cathode resistance (typical values) for TS12 series

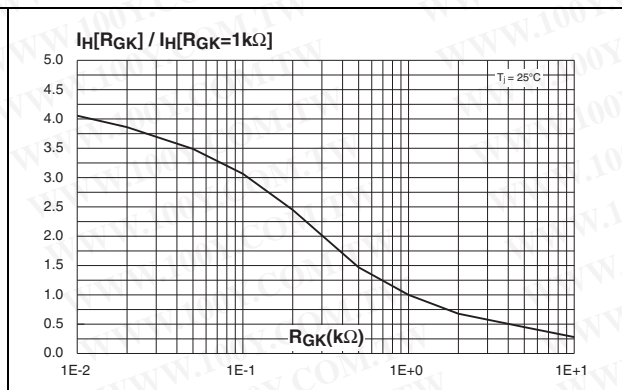

Figure 9. Relative variation of  $dV/dt$  immunity versus gate-cathode resistance (typical values) for TS12 series

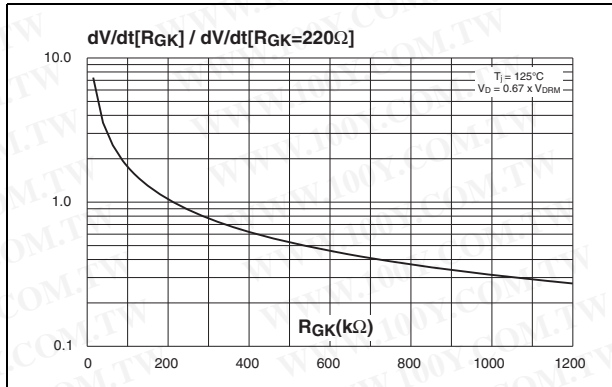

Figure 10. Relative variation of  $dV/dt$  immunity versus gate-cathode capacitance (typical values) for TS12 series

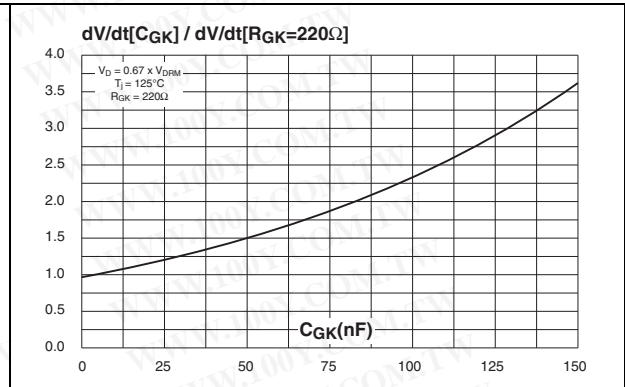

Figure 11. Surge peak on-state current versus number of cycles

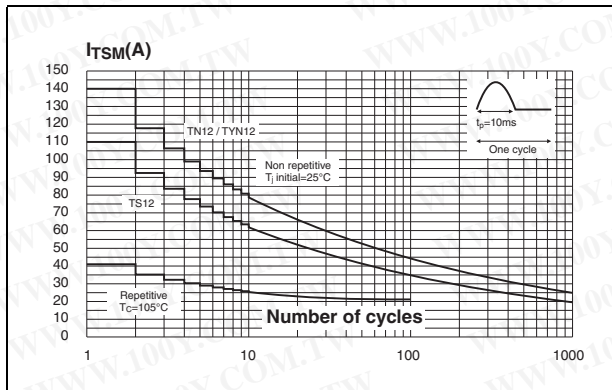

Figure 12. Non-repetitive surge peak on-state current for a sinusoidal pulse with width  $t_p < 10$  ms, and corresponding values of  $I^2t$

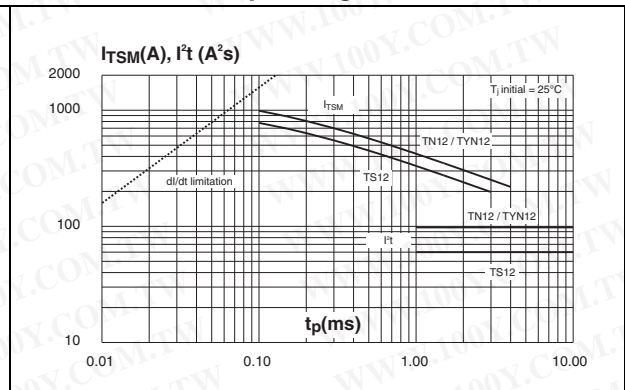

Figure 13. On-state characteristics (maximum values)

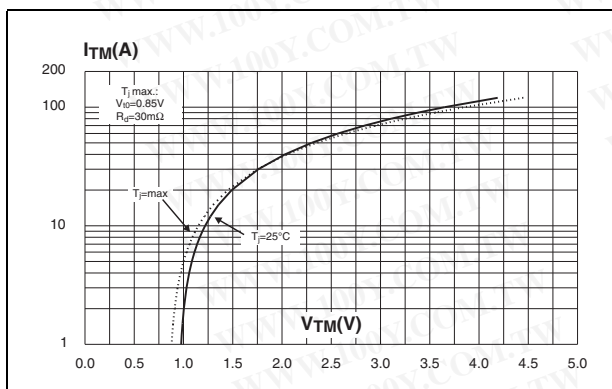
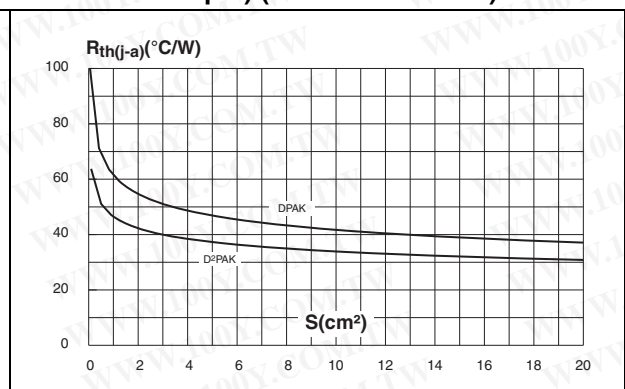

Figure 14. Thermal resistance junction to ambient versus copper surface under tab (epoxy printed circuit board FR4, copper thickness: 35  $\mu\text{m}$ ) (DPAK and D<sup>2</sup>PAK)



## 2 Ordering information scheme

Figure 15. TN12 series

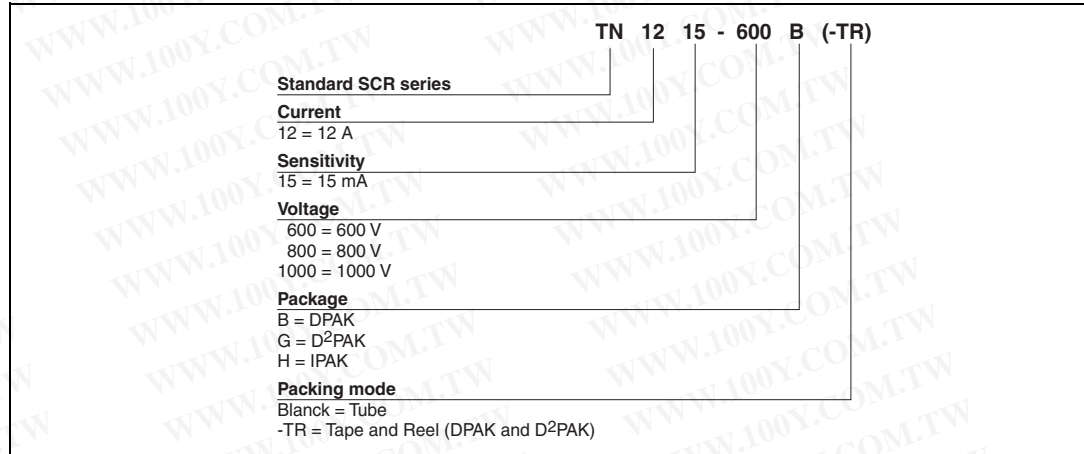

Figure 16. TS12 series

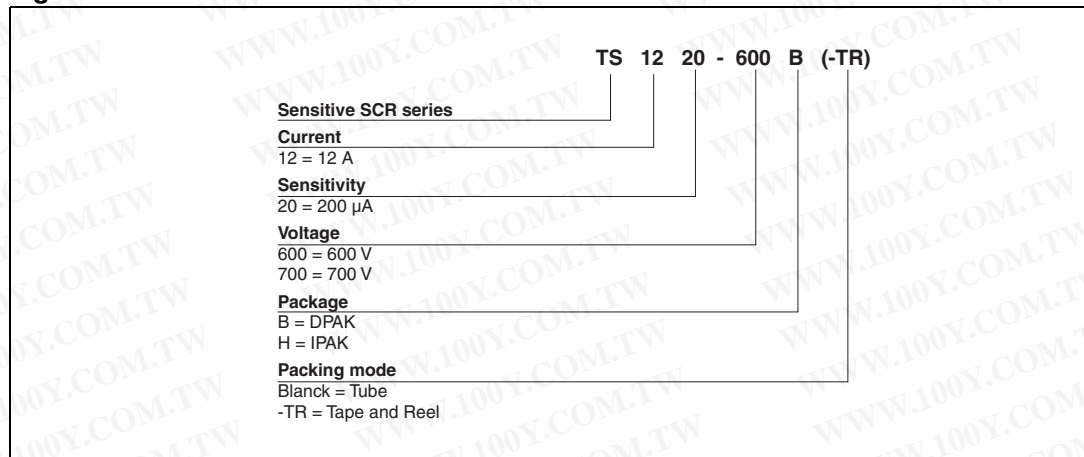

Figure 17. TYNx12 series

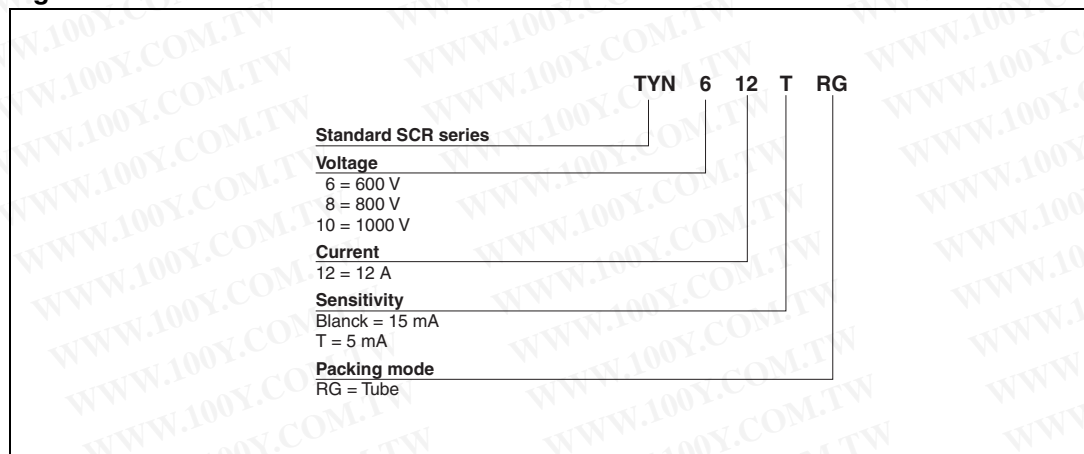

Table 5. Product selector

Part Numbers	Voltage (xxx)				Sensitivity	Package
	600 V	700 V	800 V	1000 V		
TN1215-xxxB	X		X		15 mA	DPAK
TN1215-xxxG	X		X		15 mA	D <sup>2</sup> PAK
TN1215-xxxH	X		X		15 mA	IPAK
TS1220-xxxB	X	X			0.2 mA	DPAK
TS1220-xxxH	X				0.2 mA	IPAK
TYNx12	X		X	X	15 mA	TO-220AB
TYNx12T	X		X	X	5 mA	TO-220AB

### 3 Package information

- Epoxy meets UL94, V0

勝特力材料 886-3-5753170  
 勝特力电子(上海) 86-21-34970699  
 勝特力电子(深圳) 86-755-83298787  
[Http://www.100y.com.tw](http://www.100y.com.tw)

Table 6. TO-220AB dimensions

Ref.	Dimensions					
	Millimeters			Inches		
	Min.	Typ.	Max.	Min.	Typ.	Max.
A	15.20		15.90	0.598		0.625
a1		3.75			0.147	
a2	13.00		14.00	0.511		0.551
B	10.00		10.40	0.393		0.409
b1	0.61		0.88	0.024		0.034
b2	1.23		1.32	0.048		0.051
C	4.40		4.60	0.173		0.181
c1	0.49		0.70	0.019		0.027
c2	2.40		2.72	0.094		0.107
e	2.40		2.70	0.094		0.106
F	6.20		6.60	0.244		0.259
ØI	3.75		3.85	0.147		0.151
I4	15.80	16.40	16.80	0.622	0.646	0.661
L	2.65		2.95	0.104		0.116
I2	1.14		1.70	0.044		0.066
I3	1.14		1.70	0.044		0.066
M		2.60			0.102	

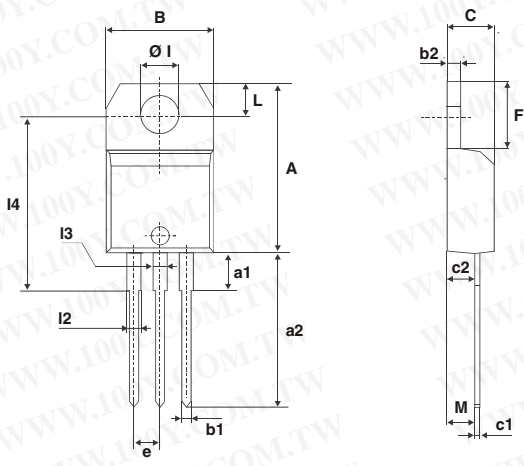
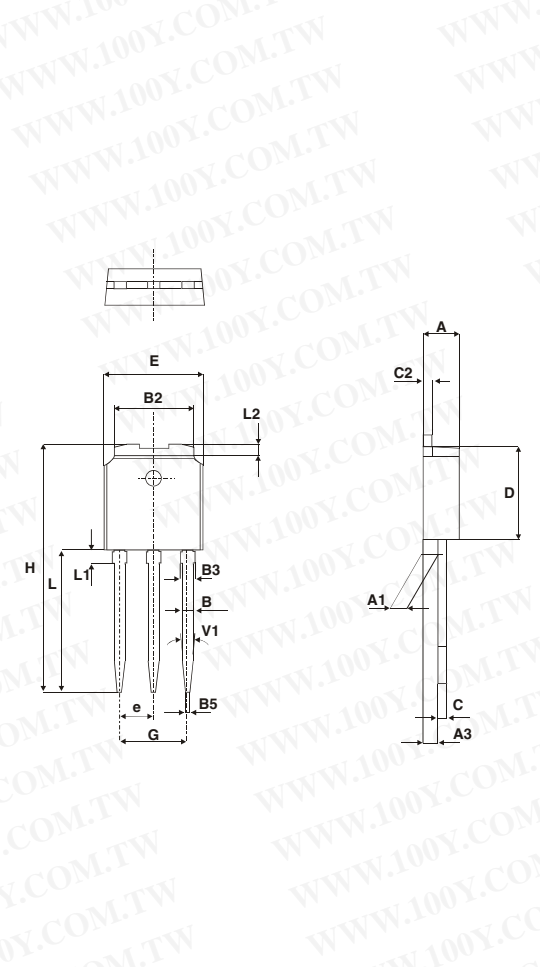

Table 7. IPAK dimensions



Ref.	Dimensions					
	Millimeters			Inches		
	Min.	Typ.	Max.	Min.	Typ.	Max.
A	2.20		2.40	0.086		0.094
A1	0.90		1.10	0.035		0.043
A3	0.70		1.30	0.027		0.051
B	0.64		0.90	0.025		0.035
B2	5.20		5.40	0.204		0.212
B3			0.95			0.037
B5		0.30			0.035	
C	0.45		0.60	0.017		0.023
C2	0.48		0.60	0.019		0.023
D	6		6.20	0.236		0.244
E	6.40		6.60	0.252		0.260
e		2.28			0.090	
G	4.40		4.60	0.173		0.181
H		16.10			0.634	
L	9		9.40	0.354		0.370
L1	0.8		1.20	0.031		0.047
L2		0.80	1		0.031	0.039
V1		10°			10°	

勝特力材料 886-3-5753170  
 勝特力电子(上海) 86-21-34970699  
 勝特力电子(深圳) 86-755-83298787  
[Http://www.100y.com.tw](http://www.100y.com.tw)

Table 8. DPAK dimensions

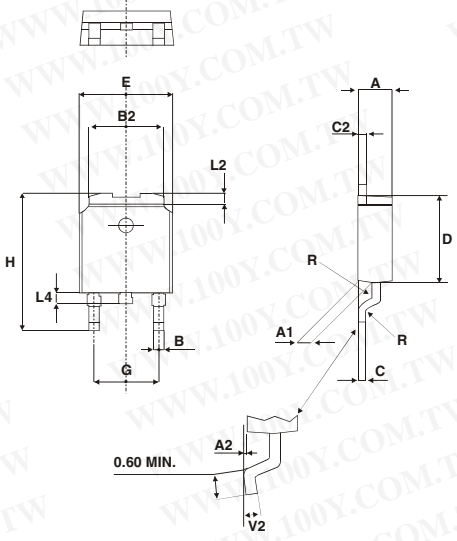

Ref.	Dimensions			
	Millimeters		Inches	
	Min.	Max.	Min.	Max.
A	2.20	2.40	0.086	0.094
A1	0.90	1.10	0.035	0.043
A2	0.03	0.23	0.001	0.009
B	0.64	0.90	0.025	0.035
B2	5.20	5.40	0.204	0.212
C	0.45	0.60	0.017	0.023
C2	0.48	0.60	0.018	0.023
D	6.00	6.20	0.236	0.244
E	6.40	6.60	0.251	0.259
G	4.40	4.60	0.173	0.181
H	9.35	10.10	0.368	0.397
L2	0.80 typ.		0.031 typ.	
L4	0.60	1.00	0.023	0.039
V2	0°	8°	0°	8°

Figure 18. DPAK footprint dimensions (in millimeters)

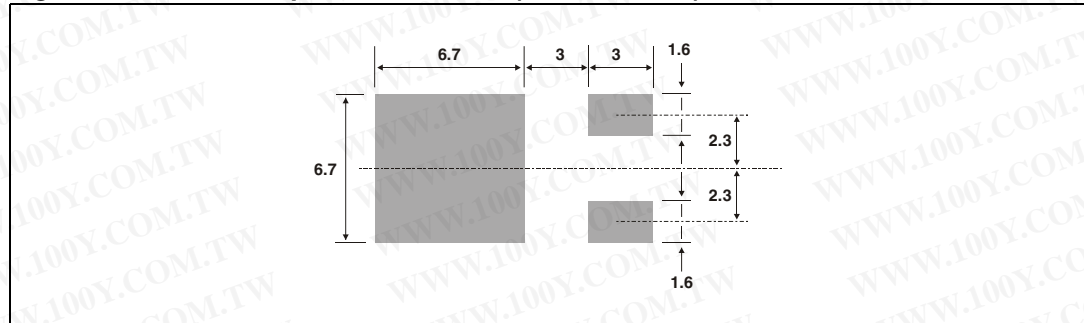

勝特力材料 886-3-5753170  
 勝特力电子(上海) 86-21-34970699  
 勝特力电子(深圳) 86-755-83298787  
[Http://www.100y.com.tw](http://www.100y.com.tw)

Table 9. D<sup>2</sup>PAK dimensions

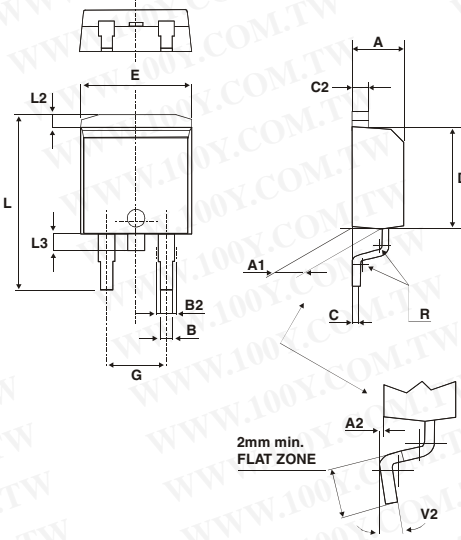

Ref.	Dimensions					
	Millimeters			Inches		
	Min.	Typ.	Max.	Min.	Typ.	Max.
A	4.30		4.60	0.169		0.181
A1	2.49		2.69	0.098		0.106
A2	0.03		0.23	0.001		0.009
B	0.70		0.93	0.027		0.037
B2	1.25	1.40		0.048	0.055	
C	0.45		0.60	0.017		0.024
C2	1.21		1.36	0.047		0.054
D	8.95		9.35	0.352		0.368
E	10.00		10.28	0.393		0.405
G	4.88		5.28	0.192		0.208
L	15.00		15.85	0.590		0.624
L2	1.27		1.40	0.050		0.055
L3	1.40		1.75	0.055		0.069
R	0.40			0.016		
V2	0°		8°	0°		8°

Figure 19. D<sup>2</sup>PAK footprint dimensions (in millimeters)

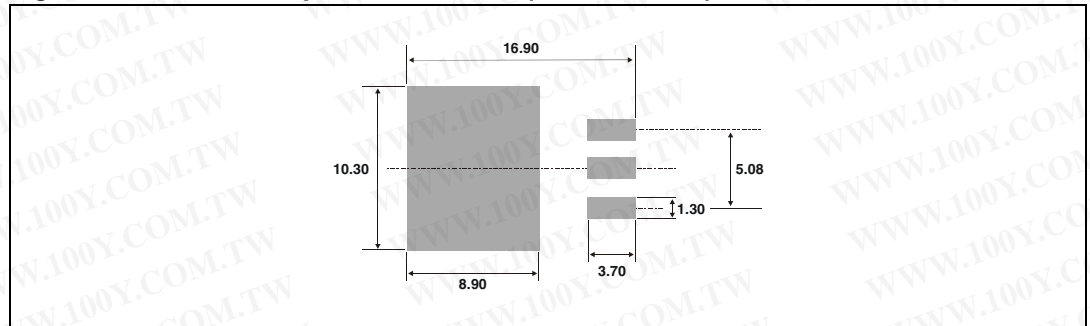

In order to meet environmental requirements, ST offers these devices in ECOPACK® packages. These packages have a lead-free second level interconnect. The category of second level interconnect is marked on the inner box label, in compliance with JEDEC Standard JESD97. The maximum ratings related to soldering conditions are also marked on the inner box label. ECOPACK is an ST trademark. ECOPACK specifications are available at: [www.st.com](http://www.st.com).

勝特力材料 886-3-5753170  
 勝特力电子(上海) 86-21-34970699  
 勝特力电子(深圳) 86-755-83298787  
[Http://www.100y.com.tw](http://www.100y.com.tw)

## 4 Ordering information

Ordering type <sup>(1)</sup>	Marking <sup>(1)</sup>	Package	Weight	Base qty	Delivery mode
TN1215-x00B	TN1215x00	DPAK	0.3 g	75	Tube
TN1215-x00B-TR	TN1215x00	DPAK	0.3 g	2500	Tape and reel
TN1215-x00G	TN1215x00G	D <sup>2</sup> PAK	1.5 g	50	Tube
TN1215-x00G-TR	TN1215x00G	D <sup>2</sup> PAK	1.5 g	1000	Tape and reel
TN1215-x00H	TN1215x00	IPAK	0.3 g	75	Tube
TS1220-x00B	TS1220x00	DPAK	0.3 g	75	Tube
TS1220-x00B-TR	TS1220x00	DPAK	0.3 g	2500	Tape and reel
TS1220-x00H	TS1220x00	IPAK	0.3 g	75	Tube
TYNx12RG	TYNx12	TO-220AB	2.3 g	50	Tube
TYNx12TRG	TYNx12T	TO-220AB	2.3 g	50	Tube

1. x (6, 7, 8, 10) depends upon voltage

## 5 Revision history

勝特力材料 886-3-5753170  
 勝特力电子(上海) 86-21-34970699  
 勝特力电子(深圳) 86-755-83298787  
[Http://www.100y.com.tw](http://www.100y.com.tw)

Date	Revision	Description of Changes
Sep-2000	3	Last update.
25-Mar-2005	4	TO-220AB delivery mode changed from bulk to tube.
14-Oct-2005	5	Changed sensitivity values in <a href="#">Table 5</a> for TYNx12 (30 to 15 mA) and TYNx12T ( 15 to 5 mA). Added ECOPACK statement.
08-Mar-2007	6	Reformatted to current standard. <a href="#">Figure 15: TN12 series</a> product name corrected. <a href="#">Figure 16: TS12 series</a> product name corrected.

勝特力材料 886-3-5753170  
勝特力电子(上海) 86-21-34970699  
勝特力电子(深圳) 86-755-83298787  
[Http://www.100y.com.tw](http://www.100y.com.tw)

**Please Read Carefully:**

Information in this document is provided solely in connection with ST products. STMicroelectronics NV and its subsidiaries ("ST") reserve the right to make changes, corrections, modifications or improvements, to this document, and the products and services described herein at any time, without notice.

All ST products are sold pursuant to ST's terms and conditions of sale.

Purchasers are solely responsible for the choice, selection and use of the ST products and services described herein, and ST assumes no liability whatsoever relating to the choice, selection or use of the ST products and services described herein.

No license, express or implied, by estoppel or otherwise, to any intellectual property rights is granted under this document. If any part of this document refers to any third party products or services it shall not be deemed a license grant by ST for the use of such third party products or services, or any intellectual property contained therein or considered as a warranty covering the use in any manner whatsoever of such third party products or services or any intellectual property contained therein.

**UNLESS OTHERWISE SET FORTH IN ST'S TERMS AND CONDITIONS OF SALE ST DISCLAIMS ANY EXPRESS OR IMPLIED WARRANTY WITH RESPECT TO THE USE AND/OR SALE OF ST PRODUCTS INCLUDING WITHOUT LIMITATION IMPLIED WARRANTIES OF MERCHANTABILITY, FITNESS FOR A PARTICULAR PURPOSE (AND THEIR EQUIVALENTS UNDER THE LAWS OF ANY JURISDICTION), OR INFRINGEMENT OF ANY PATENT, COPYRIGHT OR OTHER INTELLECTUAL PROPERTY RIGHT.**

**UNLESS EXPRESSLY APPROVED IN WRITING BY AN AUTHORIZED ST REPRESENTATIVE, ST PRODUCTS ARE NOT RECOMMENDED, AUTHORIZED OR WARRANTED FOR USE IN MILITARY, AIR CRAFT, SPACE, LIFE SAVING, OR LIFE SUSTAINING APPLICATIONS, NOR IN PRODUCTS OR SYSTEMS WHERE FAILURE OR MALFUNCTION MAY RESULT IN PERSONAL INJURY, DEATH, OR SEVERE PROPERTY OR ENVIRONMENTAL DAMAGE. ST PRODUCTS WHICH ARE NOT SPECIFIED AS "AUTOMOTIVE GRADE" MAY ONLY BE USED IN AUTOMOTIVE APPLICATIONS AT USER'S OWN RISK.**

Resale of ST products with provisions different from the statements and/or technical features set forth in this document shall immediately void any warranty granted by ST for the ST product or service described herein and shall not create or extend in any manner whatsoever, any liability of ST.

ST and the ST logo are trademarks or registered trademarks of ST in various countries.

Information in this document supersedes and replaces all information previously supplied.

The ST logo is a registered trademark of STMicroelectronics. All other names are the property of their respective owners.

© 2007 STMicroelectronics - All rights reserved

STMicroelectronics group of companies

Australia - Belgium - Brazil - Canada - China - Czech Republic - Finland - France - Germany - Hong Kong - India - Israel - Italy - Japan - Malaysia - Malta - Morocco - Singapore - Spain - Sweden - Switzerland - United Kingdom - United States of America

[www.st.com](http://www.st.com)