



## STN2NF10

N-channel 100V - 0.23Ω - 2.4A - SOT-223  
STripFET™ II Power MOSFET

### Features

Type	V <sub>DSS</sub>	R <sub>DS(on)</sub>	I <sub>D</sub>
STN2NF10	100V	< 0.26Ω	2.4A

### Description

This Power MOSFET is the latest development of STMicroelectronics unique “single feature size” strip-based process. The resulting transistor shows extremely high packing density for low on-resistance, rugged avalanche characteristics and less critical alignment steps therefore a remarkable manufacturing reproducibility.

### Application

- Switching application
  - DC-DC converters

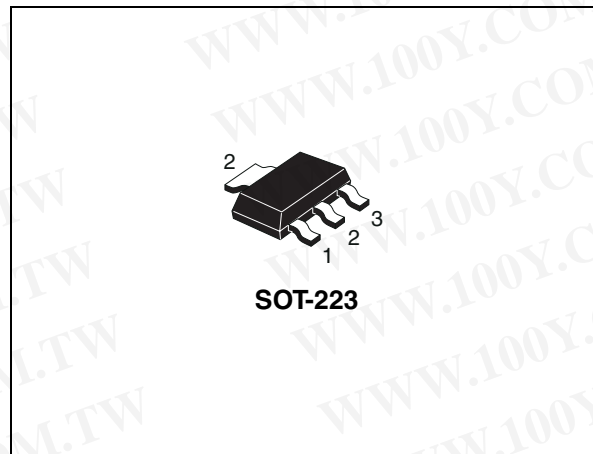

### Internal schematic diagram

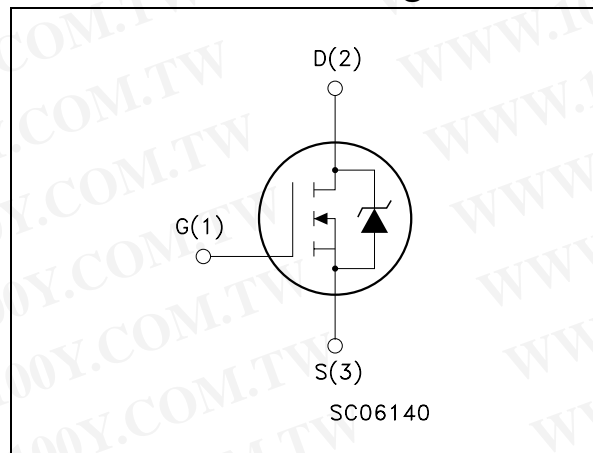

### Order code

Part number	Marking	Package	Packaging
STN2NF10	N2NF10	SOT-223	Tape & reel

勝特力材料 886-3-5753170  
勝特力电子(上海) 86-21-34970699  
勝特力电子(深圳) 86-755-83298787  
[Http://www.100y.com.tw](http://www.100y.com.tw)

# Contents

<b>1</b>	<b>Electrical ratings</b> .....	<b>3</b>
<b>2</b>	<b>Electrical characteristics</b> .....	<b>4</b>
	2.1 Electrical characteristics (curves) .....	6
<b>3</b>	<b>Test circuit</b> .....	<b>9</b>
<b>4</b>	<b>Package mechanical data</b> .....	<b>10</b>
<b>5</b>	<b>Revision history</b> .....	<b>12</b>

勝特力材料 886-3-5753170  
 勝特力电子(上海) 86-21-34970699  
 勝特力电子(深圳) 86-755-83298787  
[Http://www.100y.com.tw](http://www.100y.com.tw)

# 1 Electrical ratings

**Table 1. Absolute maximum ratings**

Symbol	Parameter	Value	Unit
$V_{DS}$	Drain-source voltage ( $V_{GS}=0$ )	100	V
$V_{GS}$	Gate-source voltage	$\pm 20$	V
$I_D$	Drain current (continuous) at $T_C = 25^\circ\text{C}$	2.4	A
$I_D$	Drain current (continuous) at $T_C = 100^\circ\text{C}$	1.5	A
$I_{DM}^{(1)}$	Drain current (pulsed)	17	A
	Derating factor	0.026	W/ $^\circ\text{C}$
$P_{TOT}^{(2)}$	Total dissipation at $T_C = 25^\circ\text{C}$	3.3	W
$E_{AS}^{(3)}$	Single pulse avalanche energy	200	mJ
$dv/dt^{(4)}$	Peak diode recovery voltage slope	30	V/ns
$T_j$ $T_{stg}$	Operating junction temperature Storage temperature	-55 to 150	$^\circ\text{C}$

1. Pulse width limited by safe operating area
2. This value is rated according to  $R_{thj-amb}$ ,  $t \leq 10\text{sec}$
3.  $I_{AS} = 2.4\text{A}$ ,  $V_{DD} = 30\text{V}$ ,  $R_g = 4.7\Omega$ , starting  $T_j = 25^\circ\text{C}$
4.  $I_{SD} \leq 6\text{A}$ ,  $di/dt \leq 500\text{A}/\mu\text{s}$ ,  $V_{DD} = 80\% V_{(BR)DSS}$

**Table 2. Thermal data**

Symbol	Parameter	Value	Unit
$R_{thj-amb}^{(1)}$	Thermal resistance junction-amb	38	$^\circ\text{C}/\text{W}$
$R_{thj-amb}^{(2)}$	Thermal resistance junction-amb	62.5	$^\circ\text{C}/\text{W}$

1. When mounted on 1inch<sup>2</sup> FR-4 board, 2 oz. Cu, ( $t < 10\text{sec}$ )
2. When mounted on 1inch<sup>2</sup> FR-4 board, 2 oz. Cu, ( $t > 10\text{sec}$ )

勝特力材料 886-3-5753170  
 勝特力电子(上海) 86-21-34970699  
 勝特力电子(深圳) 86-755-83298787  
[Http://www.100y.com.tw](http://www.100y.com.tw)

## 2 Electrical characteristics

( $T_{CASE}=25^{\circ}C$  unless otherwise specified)

**Table 3. On/off states**

Symbol	Parameter	Test conditions	Min.	Typ.	Max.	Unit
$V_{(BR)DSS}$	Drain-source breakdown voltage	$I_D = 250\mu A, V_{GS} = 0$	100			V
$I_{DSS}$	Zero gate voltage drain current ( $V_{GS} = 0$ )	$V_{DS} = \text{Max rating},$ $V_{DS} = \text{Max rating}, T_c = 125^{\circ}C$ $V_{DS} = 30V, T_c = 125^{\circ}C$			1 10 1	$\mu A$ $\mu A$ $\mu A$
$I_{GSS}$	Gate body leakage current ( $V_{DS} = 0$ )	$V_{GS} = \pm 20V$			$\pm 100$	nA
$V_{GS(th)}$	Gate threshold voltage	$V_{DS} = V_{GS}, I_D = 250\mu A$	2		4	V
$R_{DS(on)}$	Static drain-source on resistance	$V_{GS} = 10V, I_D = 1.2A$		0.23	0.26	$\Omega$

**Table 4. Dynamic**

Symbol	Parameter	Test conditions	Min.	Typ.	Max.	Unit
$g_{fs}$	Forward transconductance	$V_{DS} = 15V, I_D = 1.2A$		2.5		S
$C_{iss}$	Input capacitance	$V_{DS} = 25V, f = 1MHz, V_{GS} = 0$		280		pF
$C_{oss}$	Output capacitance			45		pF
$C_{rss}$	Reverse transfer capacitance			20		pF
$Q_g$	Total gate charge	$V_{DD} = 80V, I_D = 6A$		10	14	nC
$Q_{gs}$	Gate-source charge	$V_{GS} = 10V$		2.5		nC
$Q_{gd}$	Gate-drain charge	(see Figure 15)		4		nC

勝特力材料 886-3-5753170  
 勝特力电子(上海) 86-21-34970699  
 勝特力电子(深圳) 86-755-83298787  
[Http://www.100y.com.tw](http://www.100y.com.tw)

Table 5. Switching times

Symbol	Parameter	Test conditions	Min.	Typ.	Max.	Unit
$t_{d(on)}$ $t_r$	Turn-on delay time Rise time	$V_{DD}=50V$ , $I_D = 2.4A$ $V_{GS}=10V$ , $R_G=4.7\Omega$ (see Figure 14)		6 10		ns ns
$t_{d(off)}$ $t_f$	Turn-off delay time Fall time	$V_{DD}=50V$ , $I_D = 2.4A$ $V_{GS}=10V$ , $R_G=4.7\Omega$ (see Figure 14)		20 3		ns ns

Table 6. Source drain diode

Symbol	Parameter	Test conditions	Min.	Typ.	Max	Unit
$I_{SD}$ $I_{SDM}^{(1)}$	Source-drain current Source-drain current (pulsed)				2.4 17	A A
$V_{SD}^{(2)}$	Forward on voltage	$I_{SD}= 2.4A$ , $V_{GS}=0$			1.2	V
$t_{rr}$ $Q_{rr}$ $I_{RRM}$	Reverse recovery time Reverse recovery charge Reverse recovery current	$I_{SD}= 6A$ , $V_{DD}=10V$ $di/dt=100A/\mu s$ , $T_j=150^\circ C$ (see Figure 19)		70 175 5		ns nC A

1. Pulse width limited by safe operating area
2. Pulsed: pulse duration = 300 $\mu s$ , duty cycle 1.5%

勝特力材料 886-3-5753170  
 勝特力电子(上海) 86-21-34970699  
 勝特力电子(深圳) 86-755-83298787  
[Http://www.100y.com.tw](http://www.100y.com.tw)

## 2.1 Electrical characteristics (curves)

Figure 1. Safe operating area

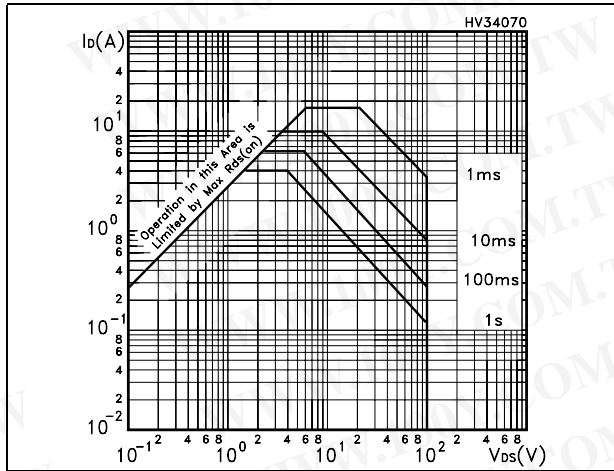

Figure 2. Thermal impedance

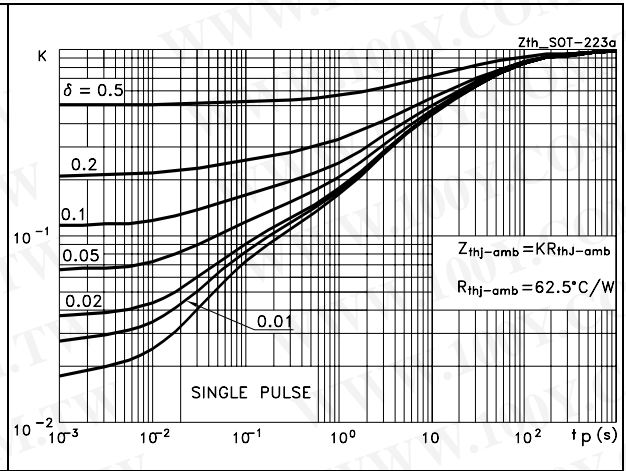

Figure 3. Output characteristics

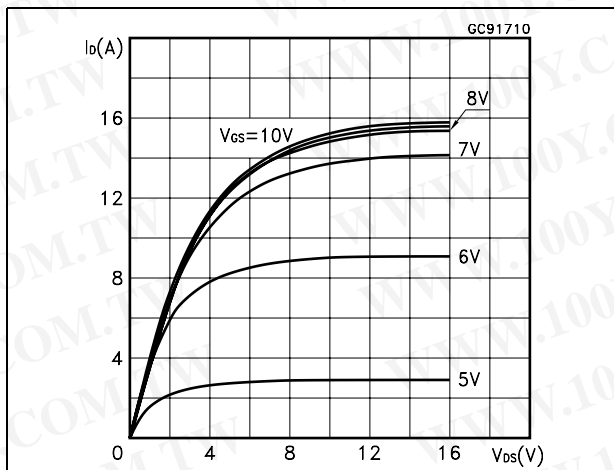

Figure 4. Transfer characteristics

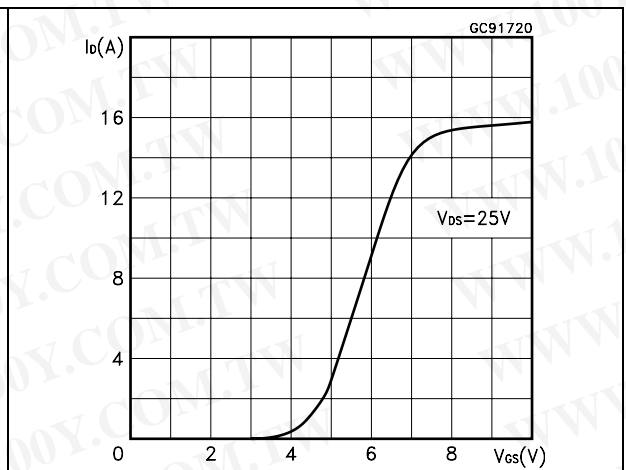

Figure 5. Transconductance

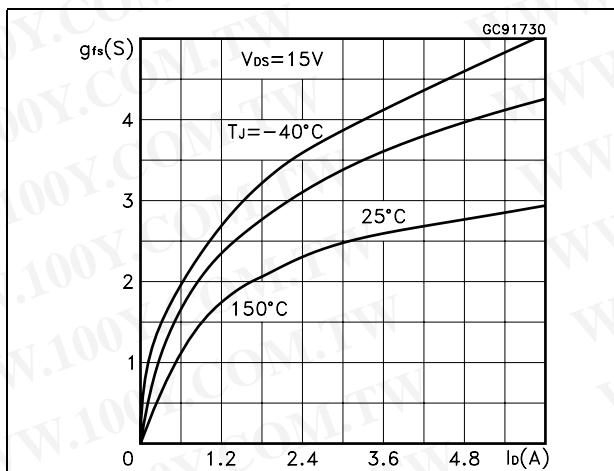
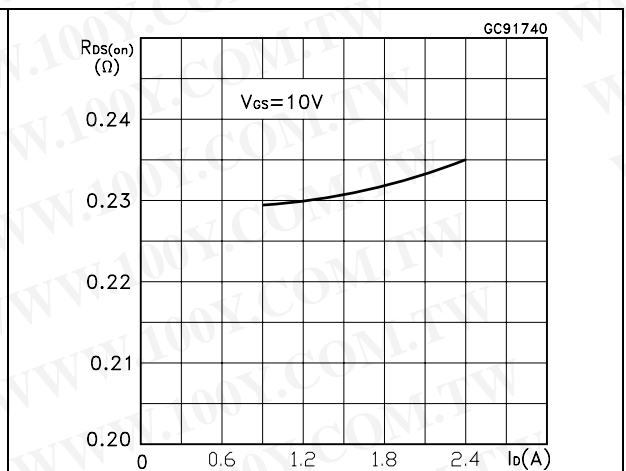
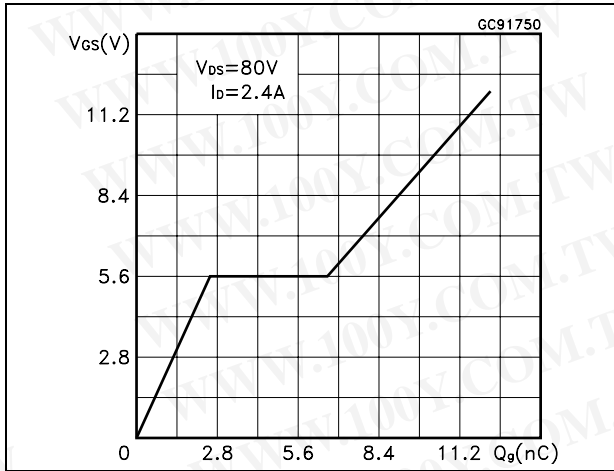

Figure 6. Static drain-source on resistance



**Figure 7. Gate charge vs. gate-source voltage**



**Figure 8. Capacitance variations**

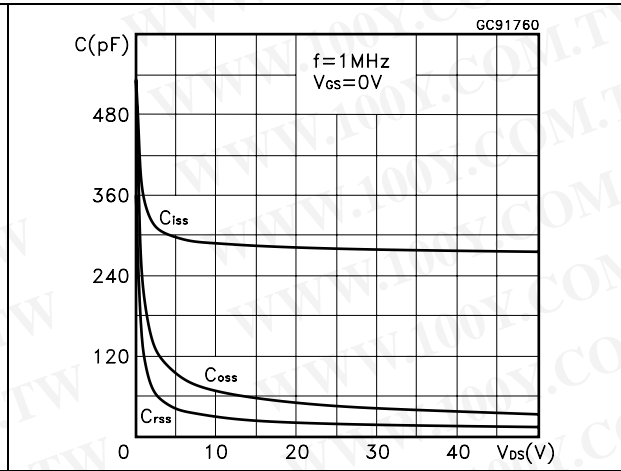

**Figure 9. Normalized gate threshold voltage vs. temperature**

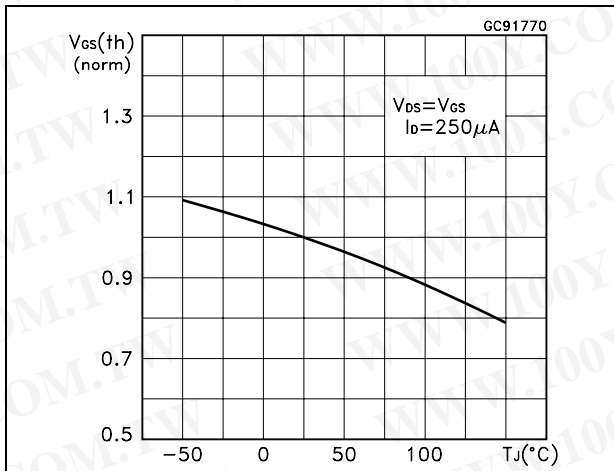

**Figure 10. Normalized on resistance vs. temperature**

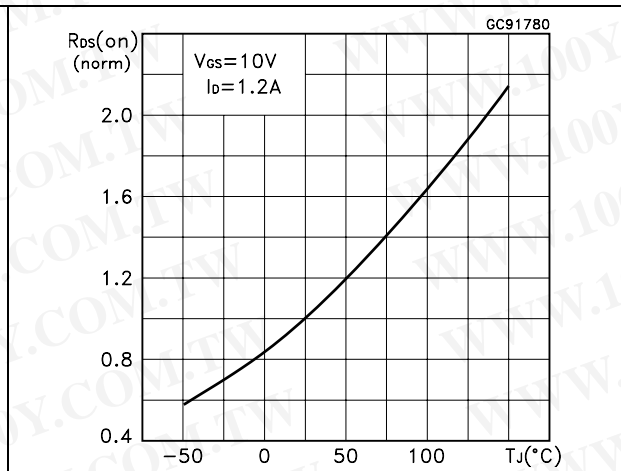

**Figure 11. Source-drain diode forward characteristics**

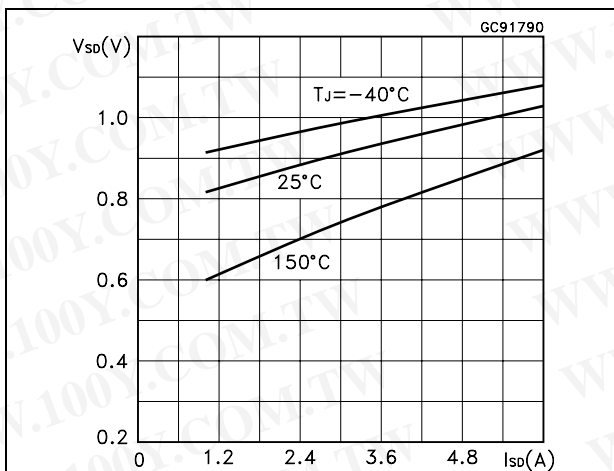

**Figure 12. Normalized BV<sub>DSS</sub> vs. temperature**

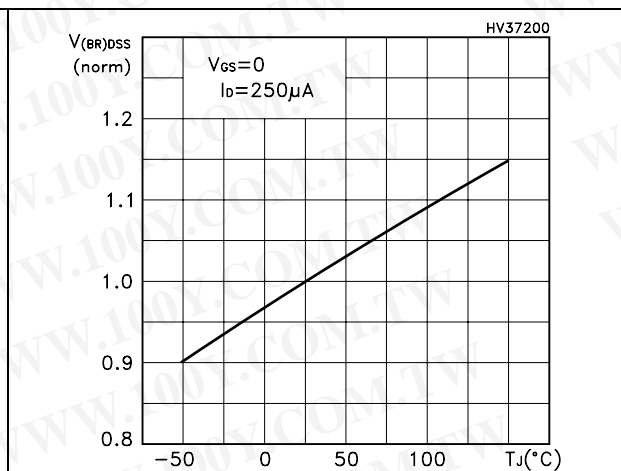
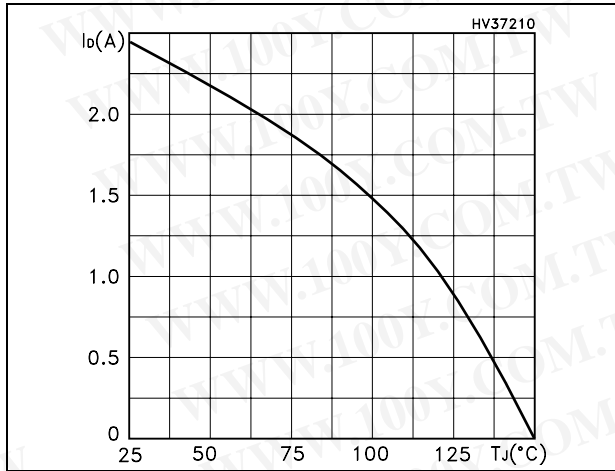

Figure 13. Max drain current vs. temperature



勝特力材料 886-3-5753170  
勝特力电子(上海) 86-21-34970699  
勝特力电子(深圳) 86-755-83298787  
[Http://www.100y.com.tw](http://www.100y.com.tw)

### 3 Test circuit

Figure 14. Switching times test circuit for resistive load

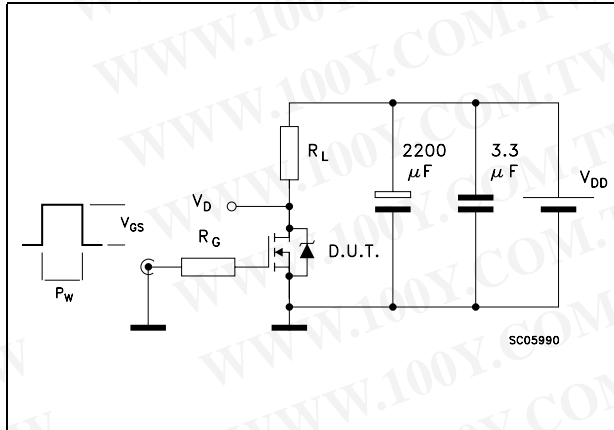

Figure 15. Gate charge test circuit

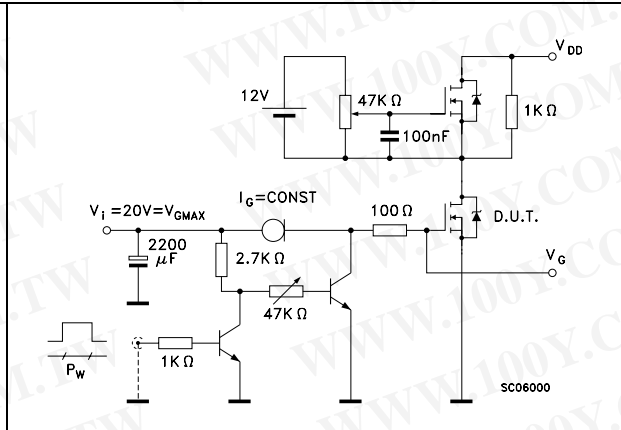

Figure 16. Test circuit for inductive load switching and diode recovery times

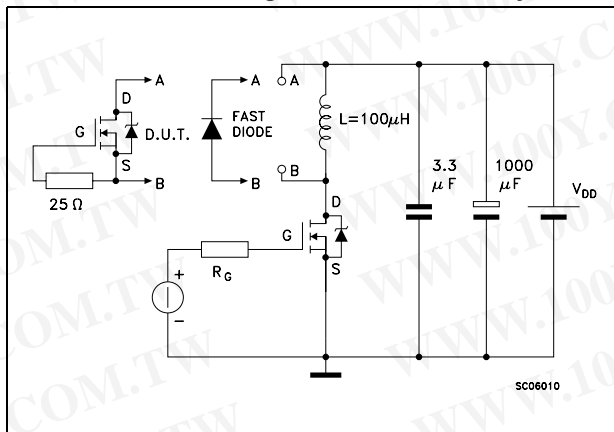

Figure 17. Unclamped inductive load test circuit

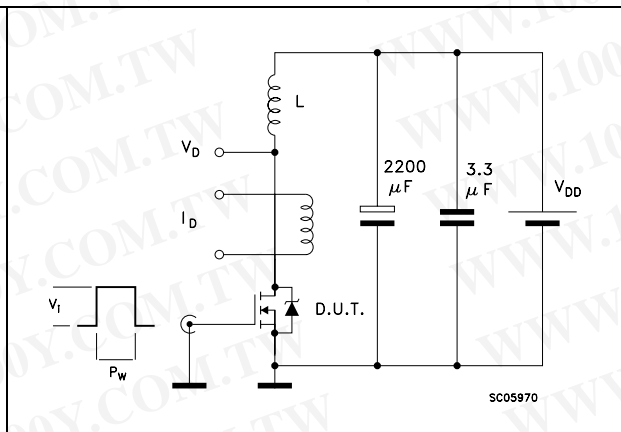

Figure 18. Unclamped inductive waveform

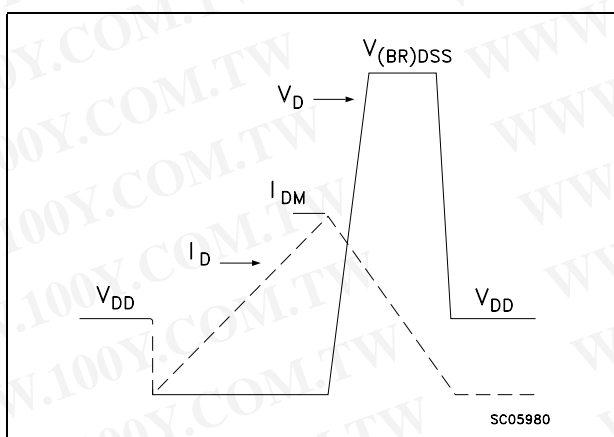
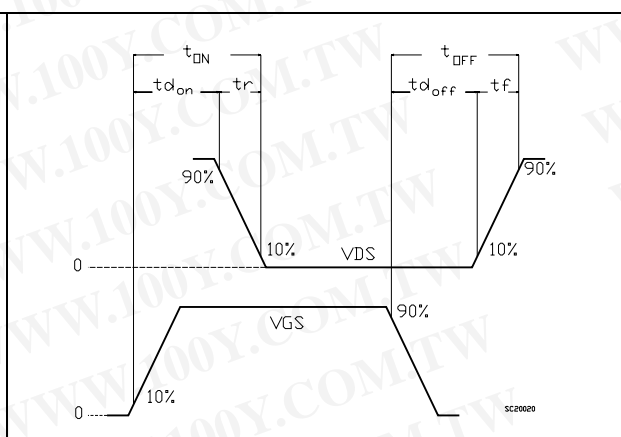

Figure 19. Switching time waveform



## 4 Package mechanical data

In order to meet environmental requirements, ST offers these devices in ECOPACK® packages. These packages have a Lead-free second level interconnect. The category of second level interconnect is marked on the package and on the inner box label, in compliance with JEDEC Standard JESD97. The maximum ratings related to soldering conditions are also marked on the inner box label. ECOPACK is an ST trademark. ECOPACK specifications are available at: [www.st.com](http://www.st.com)

SOT-223 MECHANICAL DATA

DIM.	mm			inch		
	MIN.	TYP.	MAX.	MIN.	TYP.	MAX.
A			1.80			0.071
B	0.60	0.70	0.80	0.024	0.027	0.031
B1	2.90	3.00	3.10	0.114	0.118	0.122
c	0.24	0.26	0.32	0.009	0.010	0.013
D	6.30	6.50	6.70	0.248	0.256	0.264
e		2.30			0.090	
e1		4.60			0.181	
E	3.30	3.50	3.70	0.130	0.138	0.146
H	6.70	7.00	7.30	0.264	0.276	0.287
V			10°			10°
A1		0.02				

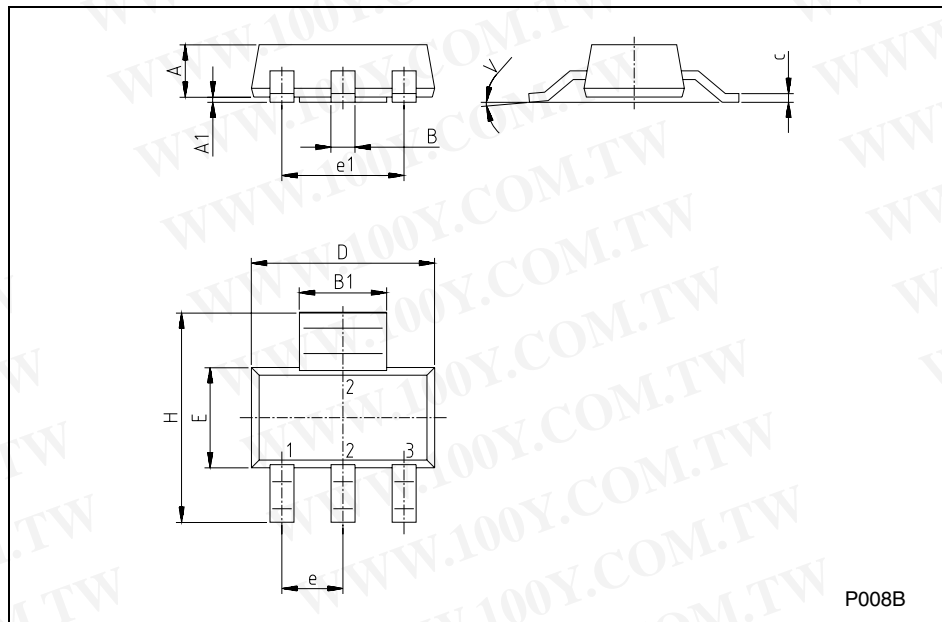

勝特力材料 886-3-5753170  
 勝特力电子(上海) 86-21-34970699  
 勝特力电子(深圳) 86-755-83298787  
[Http://www.100y.com.tw](http://www.100y.com.tw)

## 5 Revision history

Table 7. Revision history

Date	Revision	Changes
14-Sep-2006	4	The document has been reformatted
29-Mar-2007	5	<a href="#">Figure 1</a> has been updated
04-Apr-2007	6	New test condition for $I_{DSS}$ on <a href="#">Table 3</a>

勝特力材料 886-3-5753170  
勝特力电子(上海) 86-21-34970699  
勝特力电子(深圳) 86-755-83298787  
[Http://www.100y.com.tw](http://www.100y.com.tw)

勝特力材料 886-3-5753170  
勝特力电子(上海) 86-21-34970699  
勝特力电子(深圳) 86-755-83298787  
[Http://www.100y.com.tw](http://www.100y.com.tw)

**Please Read Carefully:**

Information in this document is provided solely in connection with ST products. STMicroelectronics NV and its subsidiaries ("ST") reserve the right to make changes, corrections, modifications or improvements, to this document, and the products and services described herein at any time, without notice.

All ST products are sold pursuant to ST's terms and conditions of sale.

Purchasers are solely responsible for the choice, selection and use of the ST products and services described herein, and ST assumes no liability whatsoever relating to the choice, selection or use of the ST products and services described herein.

No license, express or implied, by estoppel or otherwise, to any intellectual property rights is granted under this document. If any part of this document refers to any third party products or services it shall not be deemed a license grant by ST for the use of such third party products or services, or any intellectual property contained therein or considered as a warranty covering the use in any manner whatsoever of such third party products or services or any intellectual property contained therein.

**UNLESS OTHERWISE SET FORTH IN ST'S TERMS AND CONDITIONS OF SALE ST DISCLAIMS ANY EXPRESS OR IMPLIED WARRANTY WITH RESPECT TO THE USE AND/OR SALE OF ST PRODUCTS INCLUDING WITHOUT LIMITATION IMPLIED WARRANTIES OF MERCHANTABILITY, FITNESS FOR A PARTICULAR PURPOSE (AND THEIR EQUIVALENTS UNDER THE LAWS OF ANY JURISDICTION), OR INFRINGEMENT OF ANY PATENT, COPYRIGHT OR OTHER INTELLECTUAL PROPERTY RIGHT.**

**UNLESS EXPRESSLY APPROVED IN WRITING BY AN AUTHORIZED ST REPRESENTATIVE, ST PRODUCTS ARE NOT RECOMMENDED, AUTHORIZED OR WARRANTED FOR USE IN MILITARY, AIR CRAFT, SPACE, LIFE SAVING, OR LIFE SUSTAINING APPLICATIONS, NOR IN PRODUCTS OR SYSTEMS WHERE FAILURE OR MALFUNCTION MAY RESULT IN PERSONAL INJURY, DEATH, OR SEVERE PROPERTY OR ENVIRONMENTAL DAMAGE. ST PRODUCTS WHICH ARE NOT SPECIFIED AS "AUTOMOTIVE GRADE" MAY ONLY BE USED IN AUTOMOTIVE APPLICATIONS AT USER'S OWN RISK.**

Resale of ST products with provisions different from the statements and/or technical features set forth in this document shall immediately void any warranty granted by ST for the ST product or service described herein and shall not create or extend in any manner whatsoever, any liability of ST.

ST and the ST logo are trademarks or registered trademarks of ST in various countries.

Information in this document supersedes and replaces all information previously supplied.

The ST logo is a registered trademark of STMicroelectronics. All other names are the property of their respective owners.

© 2007 STMicroelectronics - All rights reserved

STMicroelectronics group of companies

Australia - Belgium - Brazil - Canada - China - Czech Republic - Finland - France - Germany - Hong Kong - India - Israel - Italy - Japan - Malaysia - Malta - Morocco - Singapore - Spain - Sweden - Switzerland - United Kingdom - United States of America

[www.st.com](http://www.st.com)

