

# SKKT 570, SKKH 570



SEMIPACK<sup>®</sup> 5

## Thyristor / Diode Modules

SKKT 570

SKKH 570

### Features

- Heat transfer through aluminium nitride ceramic insulated metal baseplate
- Precious metal pressure contacts for high reliability
- Thyristor with amplifying gate
- UL recognized, file no. E63532

### Typical Applications\*

- AC motor softstarters
- Input converters for AC inverter drives
- DC motor control (e.g. for machine tools)
- Temperature control (e.g. for ovens, chemical, processes)
- Professionals light dimming (studios, theaters)

1) see assembly instructions

2) screws must be lubricated

$V_{RSM}$ V	$V_{RRM}, V_{DRM}$ V	$I_{TRMS} = 1000$ A (maximum value for continuous operation) $I_{TAV} = 570$ A (sin. 180; $T_c = 85$ °C)	
1300	1200	SKKT 570/12 E	SKKH 570/12 E
1700	1600	SKKT 570/16 E	SKKH 570/16 E
1900	1800	SKKT 570/18 E	SKKH 570/18 E

Symbol	Conditions	Values	Units
$I_{TAV}$	sin. 180; $T_c = 85$ (100) °C;	570 (435)	A
$I_{TSM}$	$T_{vj} = 25$ °C; 10 ms $T_{vj} = 135$ °C; 10 ms	19000 15500	A
$i^2t$	$T_{vj} = 25$ °C; 8,3 .. 10 ms $T_{vj} = 135$ °C; 8,3 ... 10 ms	1805000 1201250	A <sup>2</sup> s A <sup>2</sup> s
$V_T$	$T_{vj} = 25$ °C; $I_T = 1700$ A	max. 1,44	V
$V_{T(TO)}$	$T_{vj} = 135$ °C	max. 0,78	V
$r_T$	$T_{vj} = 135$ °C	max. 0,32	mΩ
$I_{DD}, I_{RD}$	$T_{vj} = 135$ °C; $V_{RD} = V_{RRM}; V_{DD} = V_{DRM}$	max. 225	mA
$t_{gd}$	$T_{vj} = 25$ °C; $I_G = 1$ A; $di_G/dt = 1$ A/μs	1	μs
$t_{gr}$	$V_D = 0,67 * V_{DRM}$	2	μs
$(di/dt)_{cr}$	$T_{vj} = 135$ °C	max. 250	A/μs
$(dv/dt)_{cr}$	$T_{vj} = 135$ °C	max. 1000	V/μs
$t_q$	$T_{vj} = 135$ °C,	100...200	μs
$I_H$	$T_{vj} = 25$ °C; typ. / max.	150 / 500	mA
$I_L$	$T_{vj} = 25$ °C; $R_G = 33$ Ω; typ. / max.	300 / 2000	mA
$V_{GT}$	$T_{vj} = 25$ °C; d.c.	min. 3	V
$I_{GT}$	$T_{vj} = 25$ °C; d.c.	min. 200	mA
$V_{GD}$	$T_{vj} = 135$ °C; d.c.	max. 0,25	V
$I_{GD}$	$T_{vj} = 135$ °C; d.c.	max. 10	mA
$R_{th(j-c)}$	cont.; per thyristor / per module	0,069 / 0,034	K/W
$R_{th(j-c)}$	sin. 180°; per thyristor / per module	0,072 / 0,036	K/W
$R_{th(j-c)}$	rec. 120°; per thyristor / per module	0,077 / 0,038	K/W
$R_{th(c-s)}$	per thyristor / per module	0,02 / 0,01	K/W
$T_{vj}$		- 40 ... + 135	°C
$T_{stg}$		- 40 ... + 125	°C
$V_{isol}$	a.c. 50 Hz; r.m.s.; 1 s / 1 min.	3600 / 3000	V~
$M_s$	to heatsink	5 ± 15% <sup>1)</sup>	Nm
$M_t$	to terminals	12 ± 15% <sup>2)</sup>	Nm
$a$		5 * 9,81	m/s <sup>2</sup>
$m$	approx.	1400	g
Case	SKKT SKKH	A 60b A 66b	

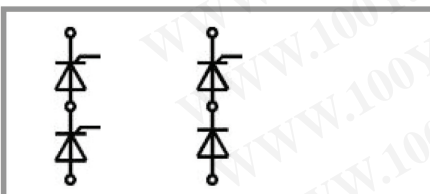

SKKT

SKKH

勝特力材料 886-3-5753170  
 勝特力电子(上海) 86-21-34970699  
 勝特力电子(深圳) 86-755-83298787  
[Http://www.100y.com.tw](http://www.100y.com.tw)

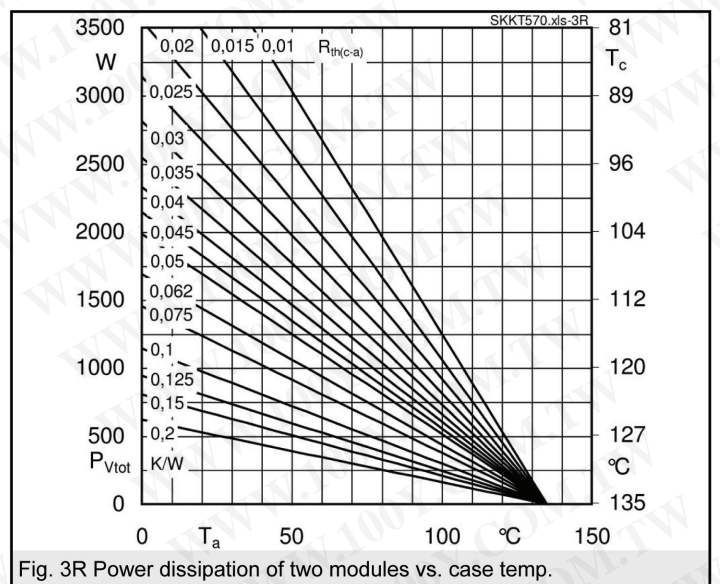
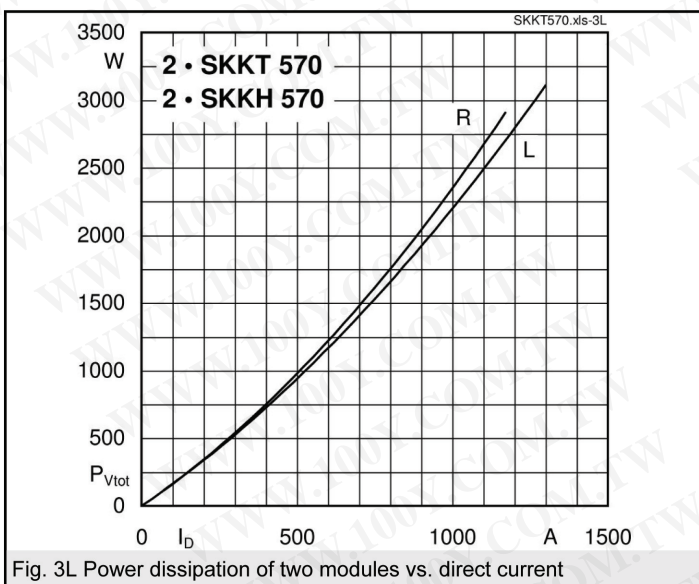
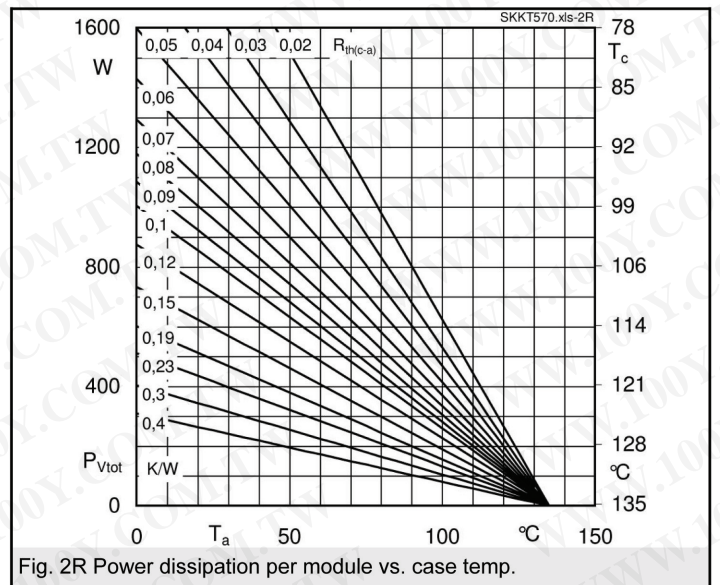
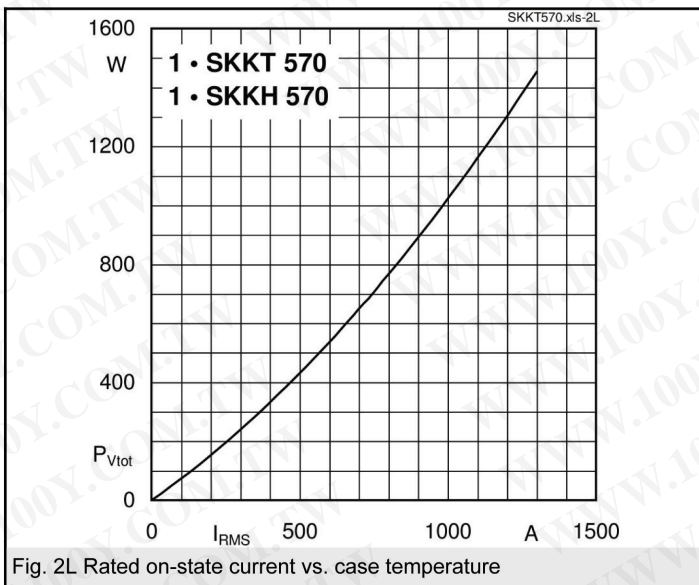
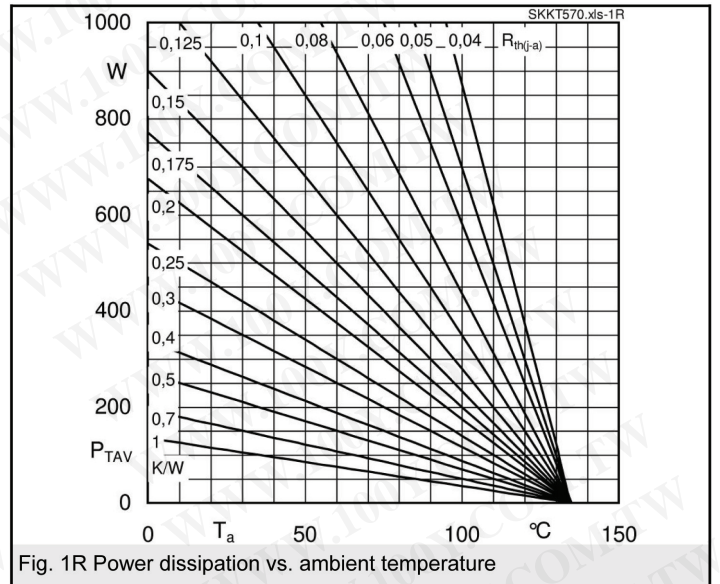
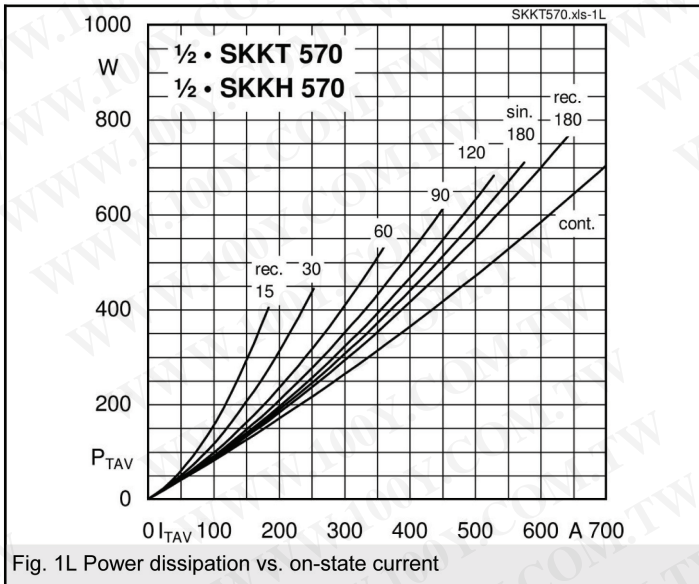

勝特力材料 886-3-5753170  
 勝特力电子(上海) 86-21-34970699  
 勝特力电子(深圳) 86-755-83298787  
[Http://www.100y.com.tw](http://www.100y.com.tw)

# SKKT 570, SKKH 570

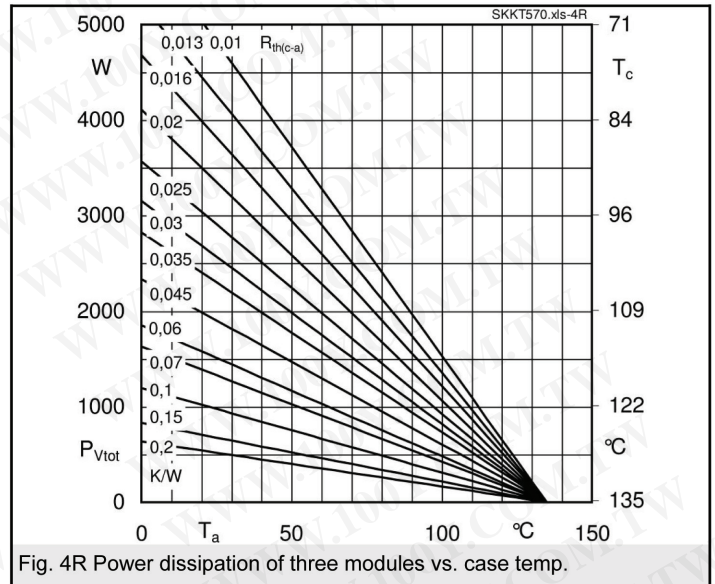
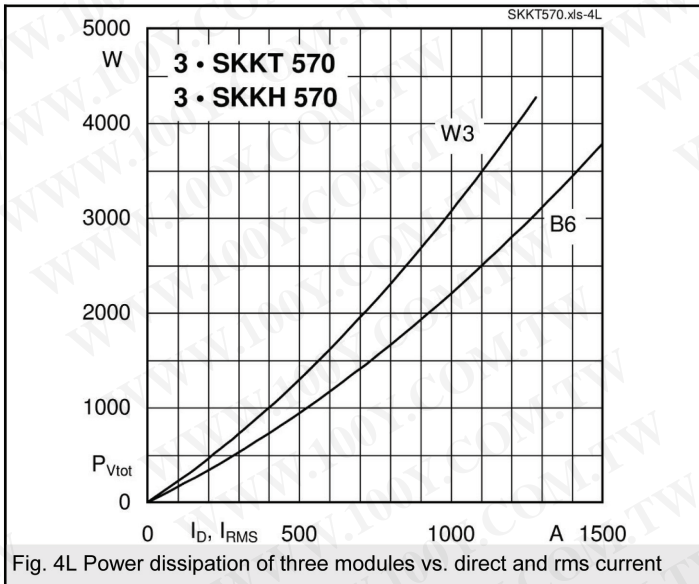

**勝特力材料 886-3-5753170**  
**勝特力电子(上海) 86-21-34970699**  
**勝特力电子(深圳) 86-755-83298787**  
[Http://www.100y.com.tw](http://www.100y.com.tw)

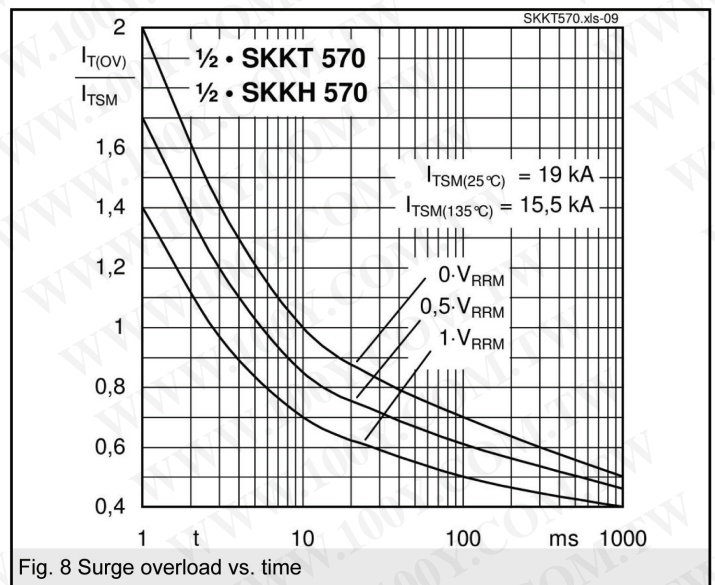
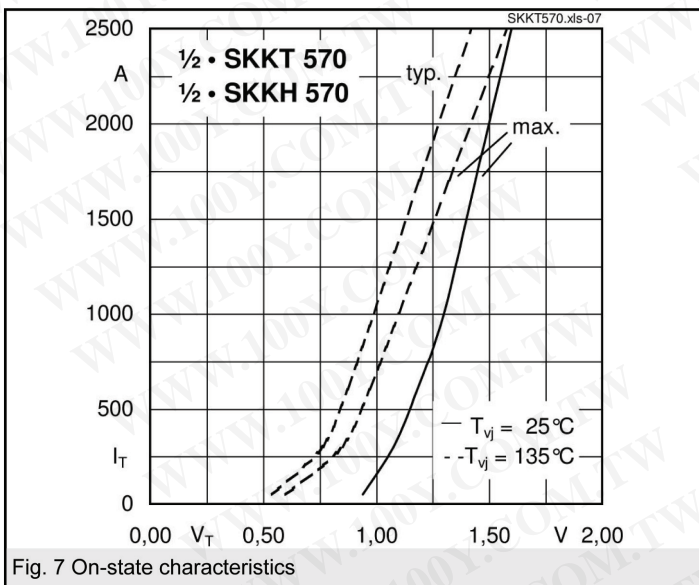
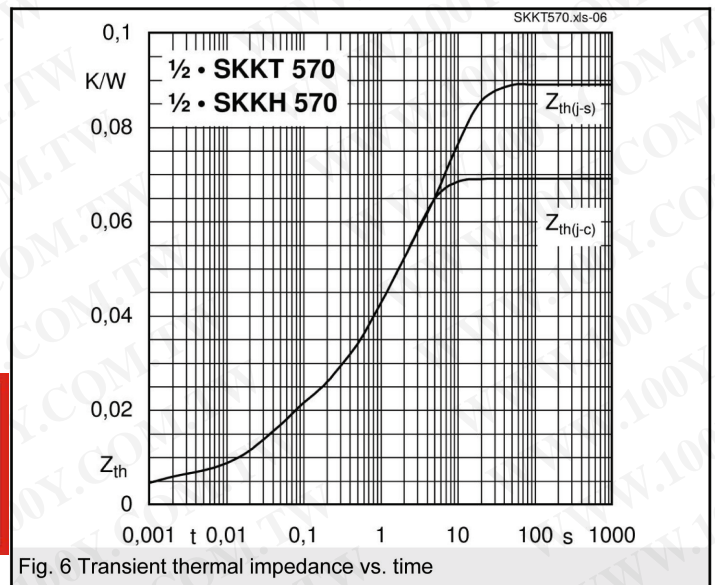

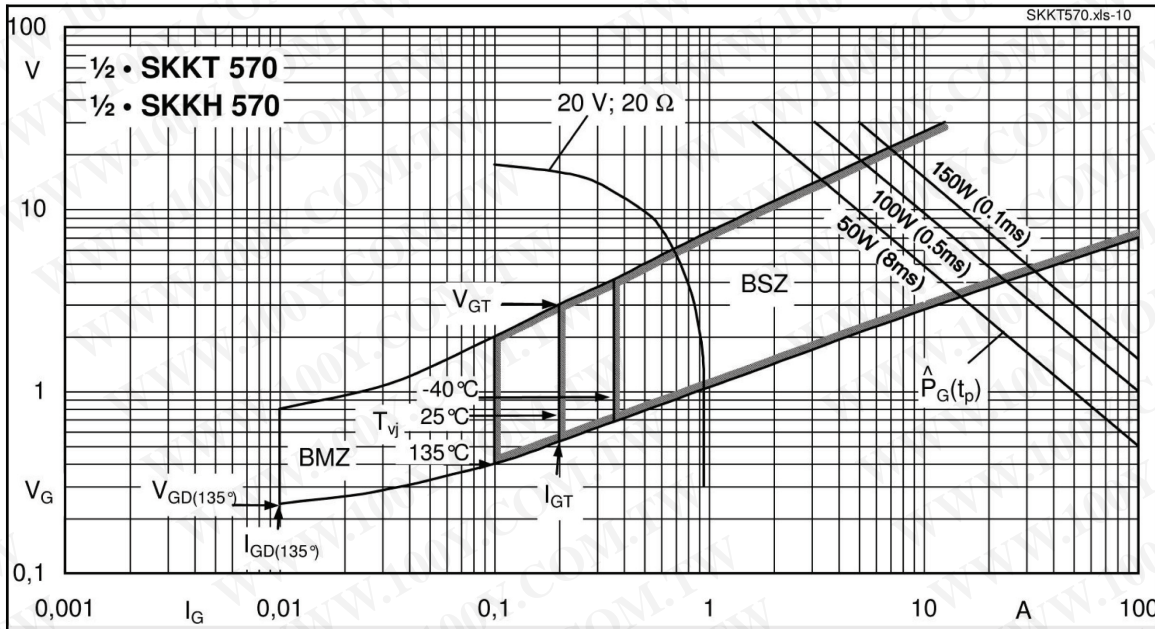
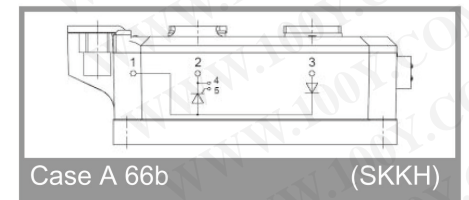
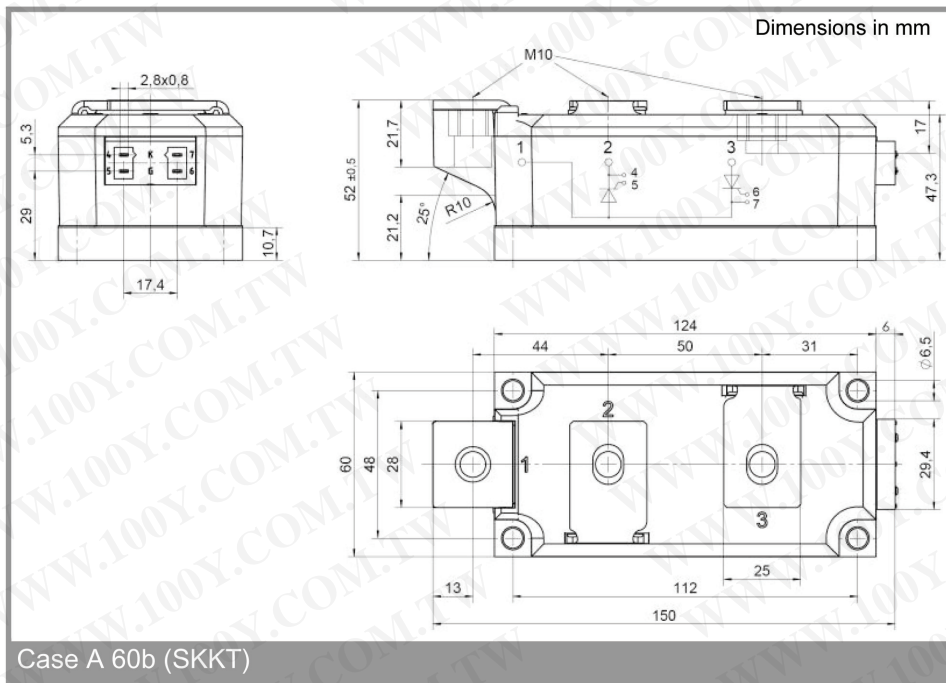

Fig. 9 Gate trigger characteristics



勝特力材料 886-3-5753170  
 勝特力电子(上海) 86-21-34970699  
 勝特力电子(深圳) 86-755-83298787  
[Http://www.100y.com.tw](http://www.100y.com.tw)

\* The specifications of our components may not be considered as an assurance of component characteristics. Components have to be tested for the respective application. Adjustments may be necessary. The use of SEMIKRON products in life support appliances and systems is subject to prior specification and written approval by SEMIKRON. We therefore strongly recommend prior consultation of our personal.