

Transistors

# 2.5V Drive Nch+SBD MOS FET

## QS5U12

●Structure

Silicon N-channel MOSFET  
 Schottky Barrier DIODE

●Features

- 1) The QS5U12 combines Nch MOSFET with a Schottky barrier diode in a single TSMT5 package.
- 2) Low on-state resistance with fast switching.
- 3) Low voltage drive (2.5V).
- 4) The Independently connected Schottky barrier diode has low forward voltage.

●Applications

Load switch, DC / DC conversion

●Packaging specifications

Type	Package	Taping
	Code	TR
	Basic ordering unit (pieces)	3000
QS5U12		○

●External dimensions (Unit : mm)

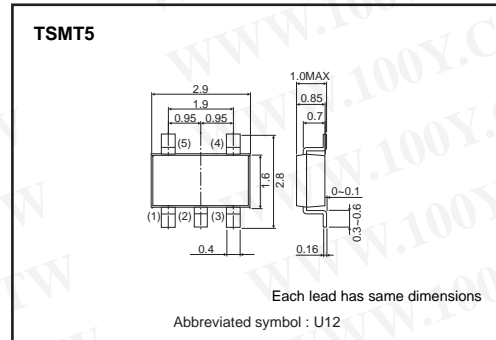

●Equivalent circuit

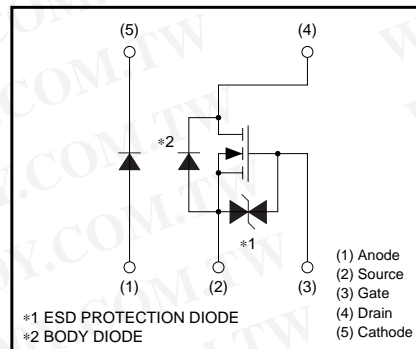

## Transistors

### ●Absolute maximum ratings (Ta=25°C)

#### <MOSFET>

Parameter	Symbol	Limits	Unit	
Drain-source voltage	V <sub>DSS</sub>	30	V	
Gate-source voltage	V <sub>GSS</sub>	12	V	
Drain current	Continuous	I <sub>D</sub>	±2.0	A
	Pulsed	I <sub>DP</sub> *1	±8.0	A
Source current (Body diode)	Continuous	I <sub>S</sub>	0.8	A
	Pulsed	I <sub>SP</sub> *1	3.2	A
Channel temperature	T <sub>ch</sub>	150	°C	
Power dissipation	P <sub>D</sub> *3	0.9	W/ELEMENT	

#### <Di>

Repetitive peak reverse voltage	V <sub>RM</sub>	25	V
Reverse voltage	V <sub>R</sub>	20	V
Forward current	I <sub>F</sub>	1.0	A
Forward current surge peak	I <sub>FSM</sub> *2	3.0	A
Junction temperature	T <sub>J</sub>	150	°C
Power dissipation	P <sub>D</sub> *3	0.7	W/ELEMENT

#### <MOSFET AND Di>

Total power dissipation	P <sub>D</sub> *3	1.25	W / TOTAL
Range of Storage temperature	T <sub>stg</sub>	-55 to +150	°C

\*1 Pw≤10μs, Duty cycles≤1% \*2 60Hz-1cyc. \*3 Mounted on a ceramic board

### ●Electrical characteristics (Ta=25°C)

#### <MOSFET>

Parameter	Symbol	Min.	Typ.	Max.	Unit	Conditions
Gate-source leakage	I <sub>GSS</sub>	-	-	10	μA	V <sub>GS</sub> =12V / V <sub>DS</sub> =0V
Drain-source breakdown voltage	V <sub>(BR) DSS</sub>	30	-	-	V	I <sub>D</sub> =1mA, / V <sub>GS</sub> =0V
Zero gate voltage drain current	I <sub>DSS</sub>	-	-	1	μA	V <sub>DS</sub> =30V / V <sub>GS</sub> =0V
Gate threshold voltage	V <sub>GS(th)</sub>	0.5	-	1.5	V	V <sub>DS</sub> =10V / I <sub>D</sub> =1mA
Static drain-source on-state resistance	R <sub>DS(on)</sub> *	-	71	100	mΩ	I <sub>D</sub> =2.0A, V <sub>GS</sub> =4.5V
		-	76	107	mΩ	I <sub>D</sub> =2.0A, V <sub>GS</sub> =4V
		-	110	154	mΩ	I <sub>D</sub> =2.0A, V <sub>GS</sub> =2.5V
Forward transfer admittance	Y <sub>fs</sub>   *	1.5	-	-	S	V <sub>DS</sub> =10V, I <sub>D</sub> =2.0A
Input capacitance	C <sub>iss</sub>	-	175	-	pF	V <sub>DS</sub> =10V
Output capacitance	C <sub>oss</sub>	-	50	-	pF	V <sub>GS</sub> =0V
Reverse transfer capacitance	C <sub>rss</sub>	-	25	-	pF	f=1MHz
Turn-on delay time	t <sub>d(on)</sub> *	-	8	-	ns	I <sub>D</sub> =1.0A V <sub>DD</sub> ≐15V
Rise time	t <sub>r</sub> *	-	10	-	ns	V <sub>GS</sub> =4.5V
Turn-off delay time	t <sub>d(off)</sub> *	-	21	-	ns	R <sub>L</sub> =15Ω
Fall time	t <sub>f</sub> *	-	8	-	ns	R <sub>G</sub> =10Ω
Total gate charge	Q <sub>g</sub> *	-	2.8	3.9	nC	V <sub>DD</sub> ≐15V
Gate-source charge	Q <sub>gs</sub> *	-	0.6	-	nC	V <sub>GS</sub> =4.5V
Gate-drain charge	Q <sub>gd</sub> *	-	0.8	-	nC	I <sub>D</sub> =2.0A

\*Pulsed

#### <Body diode (source-drain)>

Forward voltage	V <sub>SD</sub> *	-	-	1.2	V	I <sub>S</sub> =3.2A / V <sub>GS</sub> =0V
-----------------	-------------------	---	---	-----	---	--

\* Pulsed

#### <Di>

Forward voltage	V <sub>F</sub>	-	-	0.45	V	I <sub>F</sub> =1.0A
Reverse current	I <sub>R</sub>	-	-	200	μA	V <sub>R</sub> =20V

**Transistors**

**●Electrical characteristic curves**

<MOSFET>

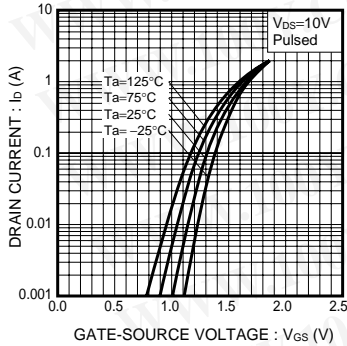

Fig.1 Typical Transfer Characteristics

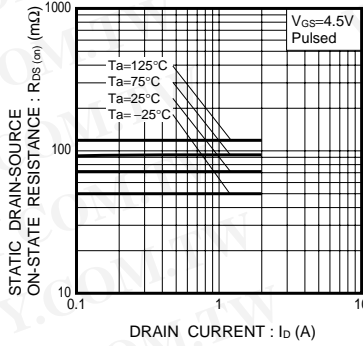

Fig.2 Static Drain-Source On-State Resistance vs. Drain Current

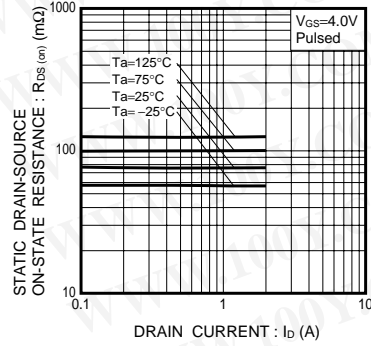

Fig.3 Static Drain-Source On-State Resistance vs. Drain Current

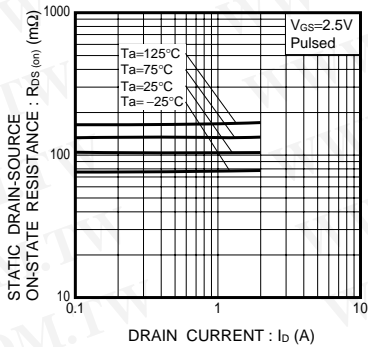

Fig.4 Static Drain-Source On-State Resistance vs. Drain Current

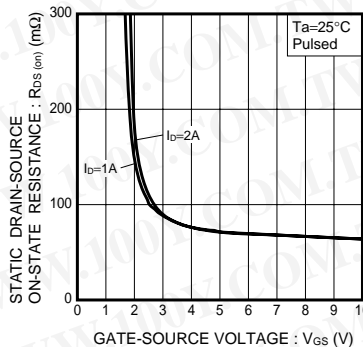

Fig.5 Static Drain-Source On-State Resistance vs. Gate-Source Voltage

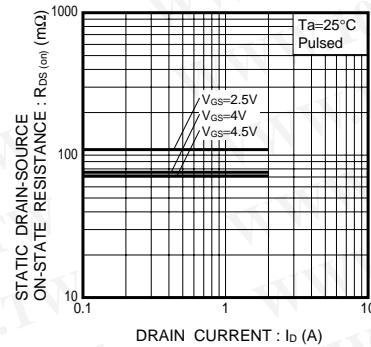

Fig.6 Static Drain-Source On-State Resistance vs. Drain Current

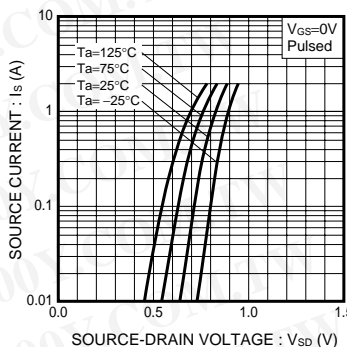

Fig.7 Reverse Drain Current vs. Source-Drain Current

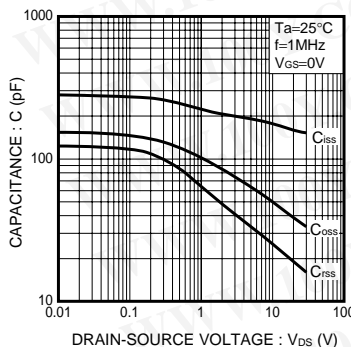

Fig.8 Typical Capacitance vs. Drain-Source Voltage

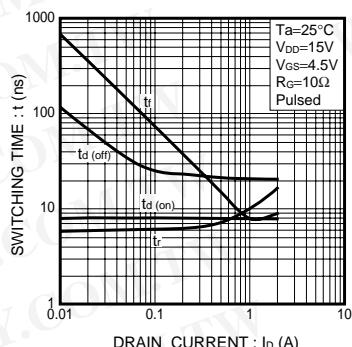

Fig.9 Switching Characteristics

Transistors

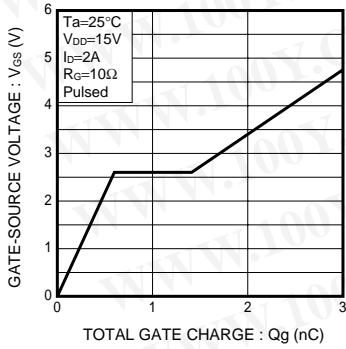

Fig.10 Dynamic Input Characteristics

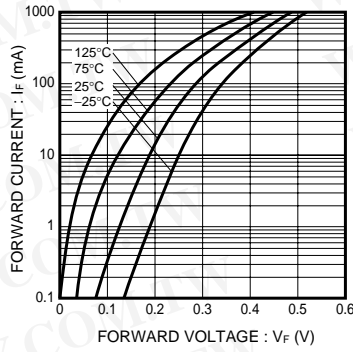

Fig.11 Forward Current vs. Forward Voltage

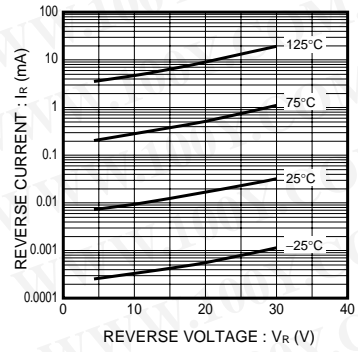

Fig.12 Reverse Current vs. Reverse Voltage

●Measurement circuits

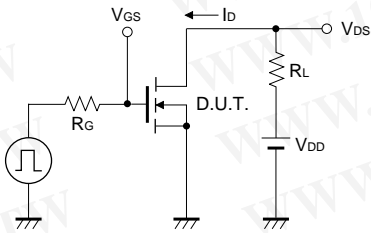

Fig.13 Switching Time Measurement Circuit

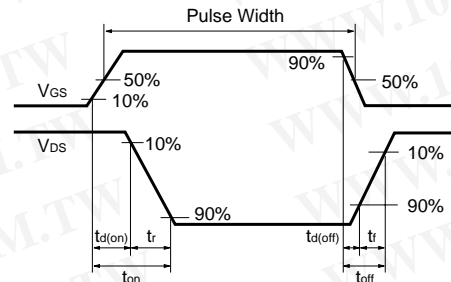

Fig.14 Switching Waveforms

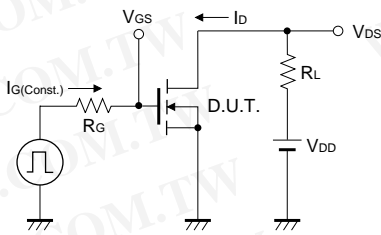

Fig.15 Gate Charge Measurement Circuit

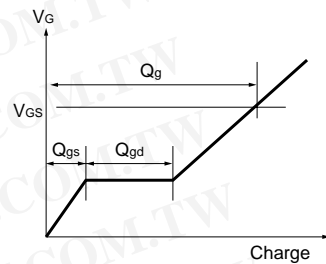

Fig.16 Gate Charge Waveform

## Appendix

### Notes

- No technical content pages of this document may be reproduced in any form or transmitted by any means without prior permission of ROHM CO.,LTD.
- The contents described herein are subject to change without notice. The specifications for the product described in this document are for reference only. Upon actual use, therefore, please request that specifications to be separately delivered.
- Application circuit diagrams and circuit constants contained herein are shown as examples of standard use and operation. Please pay careful attention to the peripheral conditions when designing circuits and deciding upon circuit constants in the set.
- Any data, including, but not limited to application circuit diagrams information, described herein are intended only as illustrations of such devices and not as the specifications for such devices. ROHM CO.,LTD. disclaims any warranty that any use of such devices shall be free from infringement of any third party's intellectual property rights or other proprietary rights, and further, assumes no liability of whatsoever nature in the event of any such infringement, or arising from or connected with or related to the use of such devices.
- Upon the sale of any such devices, other than for buyer's right to use such devices itself, resell or otherwise dispose of the same, no express or implied right or license to practice or commercially exploit any intellectual property rights or other proprietary rights owned or controlled by
- ROHM CO., LTD. is granted to any such buyer.
- Products listed in this document are no antiradiation design.

The products listed in this document are designed to be used with ordinary electronic equipment or devices (such as audio visual equipment, office-automation equipment, communications devices, electrical appliances and electronic toys).

Should you intend to use these products with equipment or devices which require an extremely high level of reliability and the malfunction of which would directly endanger human life (such as medical instruments, transportation equipment, aerospace machinery, nuclear-reactor controllers, fuel controllers and other safety devices), please be sure to consult with our sales representative in advance.

#### About Export Control Order in Japan

Products described herein are the objects of controlled goods in Annex 1 (Item 16) of Export Trade Control Order in Japan.

In case of export from Japan, please confirm if it applies to "objective" criteria or an "informed" (by MITI clause) on the basis of "catch all controls for Non-Proliferation of Weapons of Mass Destruction.