



Micro Commercial Components

# 2N7002

## Features

- Case Material: Molded Plastic. UL Flammability Classification Rating 94V-0 and MSL Rating 1
- Advanced Trench Process Technology
- High Input Impedance
- High Speed Switching
- CMOS Logic Compatible Input
- Marking : 7002/S72

## Maximum Ratings @ 25°C Unless Otherwise Specified

Symbol	Rating	Rating	Unit
$V_{DS}$	Drain-source Voltage	60	V
$I_D$	Drain Current	115	mA
$P_D$	Total Power Dissipation	200	mW
$R_{\theta JA}$	Thermal Resistance Junction to Ambient	625	°C/W
$T_J$	Operating Junction Temperature	-55 to +150	°C
$T_{STG}$	Storage Temperature	-55 to +150	°C

## Electrical Characteristics @ 25°C Unless Otherwise Specified

Symbol	Parameter	Min	Typ	Max	Units
$V_{(BR)DSS}$	Drain-Source Breakdown Voltage ( $V_{GS}=0V_{dc}$ , $I_D=10\mu A_{dc}$ )	60	---	---	Vdc
$V_{th(GS)}$	Gate-Threshold Voltage ( $V_{DS}=V_{GS}$ , $I_D=250\mu A_{dc}$ )	1.0	---	2.5	Vdc
$I_{GSS}$	Gate-body Leakage ( $V_{DS}=0V_{dc}$ , $V_{GS}=\pm 20V_{dc}$ )	---	---	$\pm 100$	nAdc
$I_{DSS}$	Zero Gate Voltage Drain Current ( $V_{DS}=60V_{dc}$ , $V_{GS}=0V_{dc}$ ) ( $V_{DS}=60V_{dc}$ , $V_{GS}=0V_{dc}$ , $T_J=125^\circ C$ )	---	---	1 500	$\mu A_{dc}$
$I_{D(ON)}$	On-state Drain Current ( $V_{DS}=7.5V_{dc}$ , $V_{GS}=10V_{dc}$ )	500	2700	---	mAdc
$r_{DS(on)}$	Drain-Source On-Resistance ( $V_{GS}=10V_{dc}$ , $I_D=500mAdc$ ) ( $V_{GS}=5V_{dc}$ , $I_D=50mAdc$ )	---	1.2 1.7	7.5 7.5	$\Omega$
$V_{DS(on)}$	Drain-Source On-Voltage ( $V_{GS}=10V_{dc}$ , $I_D=500mAdc$ ) ( $V_{GS}=5V_{dc}$ , $I_D=50mAdc$ )	---	---	3.75 1.5	Vdc
$G_{FS}$	Forward Transconductance ( $V_{DS}=10V_{dc}$ , $I_D=200mAdc$ )	80	---	---	ms
$V_{SD}$	Diode Forward Voltage ( $V_{GS}=0V_{dc}$ , $I_S=115mAdc$ )	---	---	1.5	Vdc
$I_S$	Maximum Continuous Drain-Source Diode Forward Current	-	---	115	mA
$C_{iss}$	Input Capacitance	---	---	50	pF
$C_{oss}$	Output Capacitance	---	---	25	
$C_{rSS}$	Reverse Transfer Capacitance	---	---	5	

## Switching

$t_{d(on)}$	Turn-on Time	$V_{DD}=30V_{dc}$ , $V_{GEN}=10V_{dc}$	---	---	20	ns
$t_{d(off)}$	Turn-off Time	$R_L=150\Omega$ , $I_D=200mA$ , $R_{GEN}=25\Omega$	---	---	20	

## N-Channel MOSFET

### SOT-23

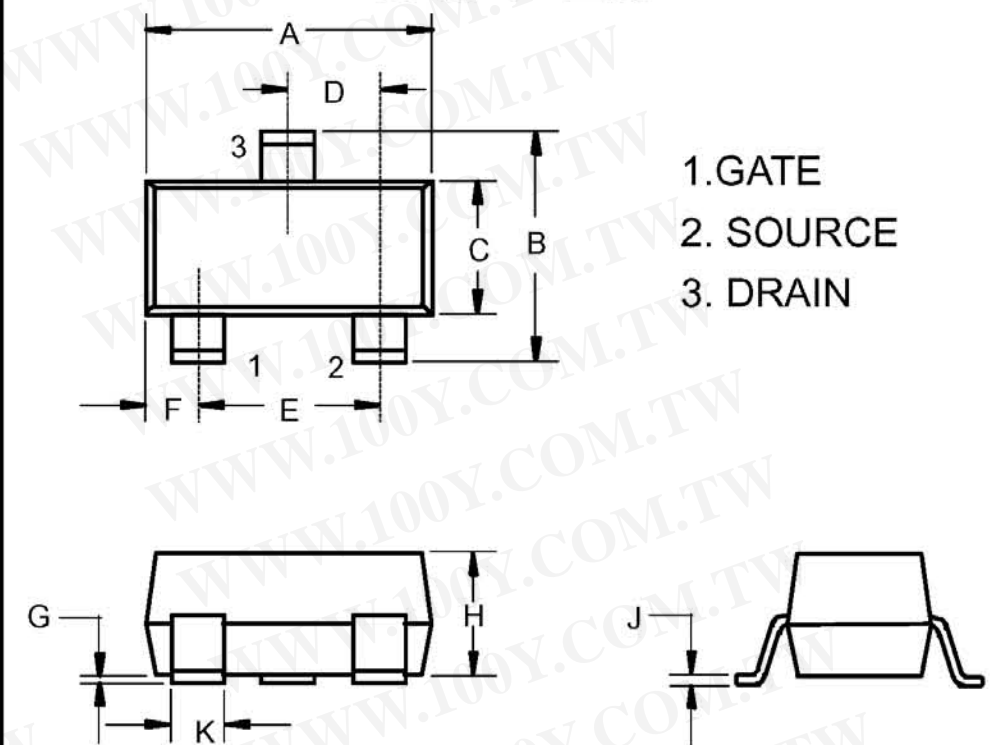

DIM	INCHES		MM		NOTE
	MIN	MAX	MIN	MAX	
A	.110	.120	2.80	3.04	
B	.083	.098	2.10	2.64	
C	.047	.055	1.20	1.40	
D	.035	.041	.89	1.03	
E	.070	.081	1.78	2.05	
F	.018	.024	.45	.60	
G	.0005	.0039	.013	.100	
H	.035	.044	.89	1.12	
J	.003	.007	.085	.180	
K	.015	.020	.37	.51	

### Suggested Solder Pad Layout

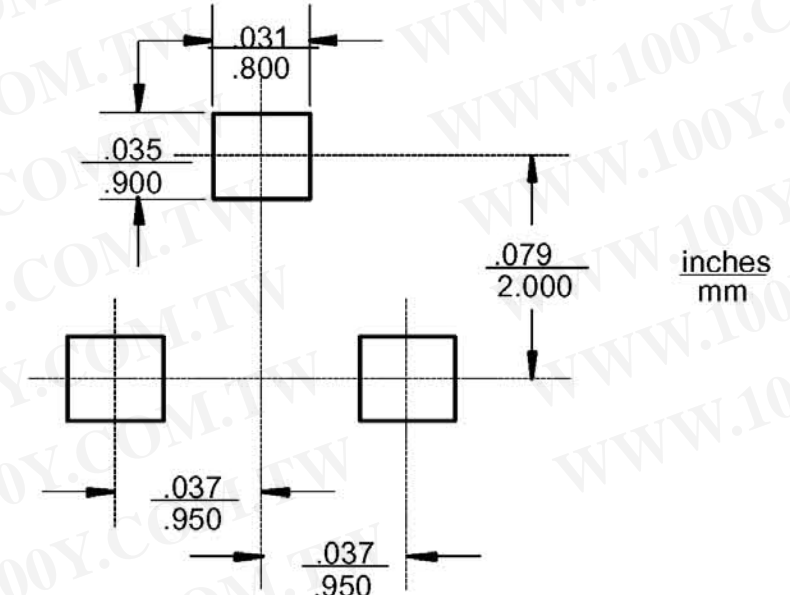

勝特力材料 886-3-5753170  
 勝特力电子(上海) 86-21-34970699  
 勝特力电子(深圳) 86-755-83298787  
[Http://www.100y.com.tw](http://www.100y.com.tw)

Fig. 1 – On-Resistance vs. Gate-to-Source Voltage

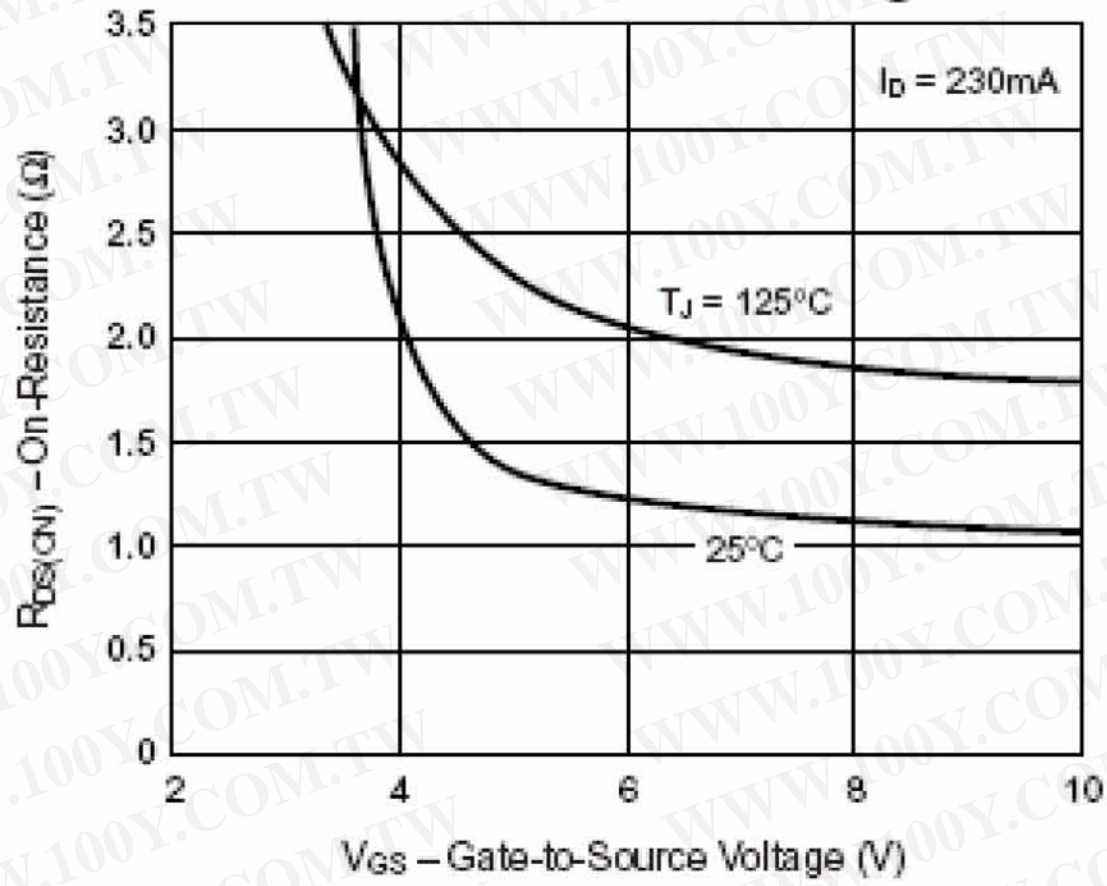

Fig. 2 – Source-Drain Diode Forward Voltage

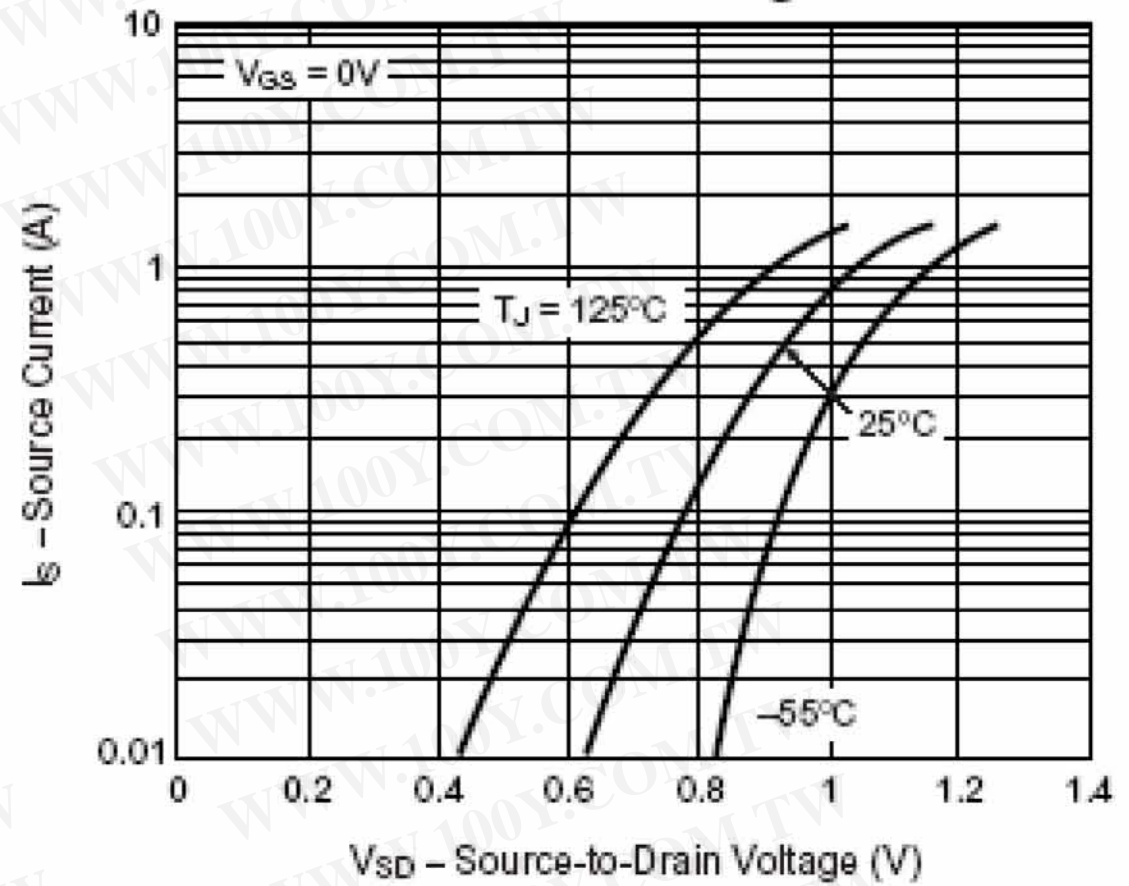

Fig. 3 – Output Characteristics

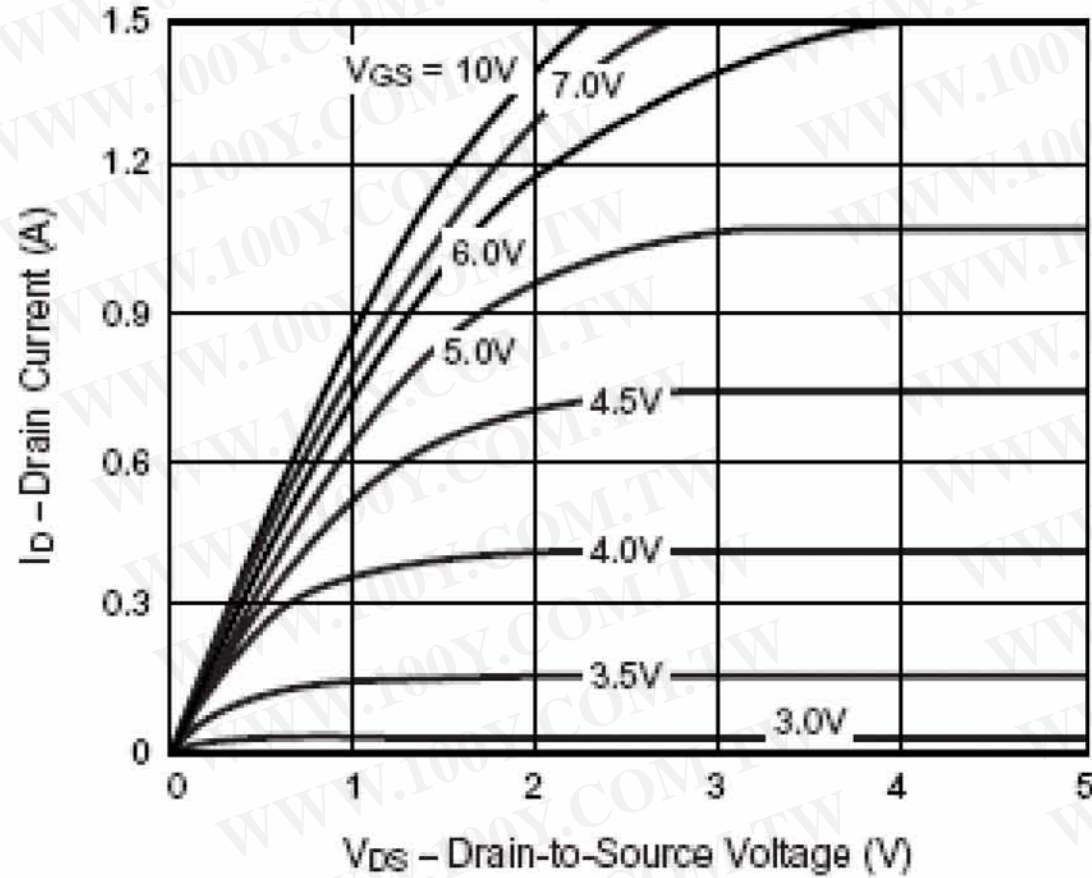

Fig. 4 – Transfer Characteristics

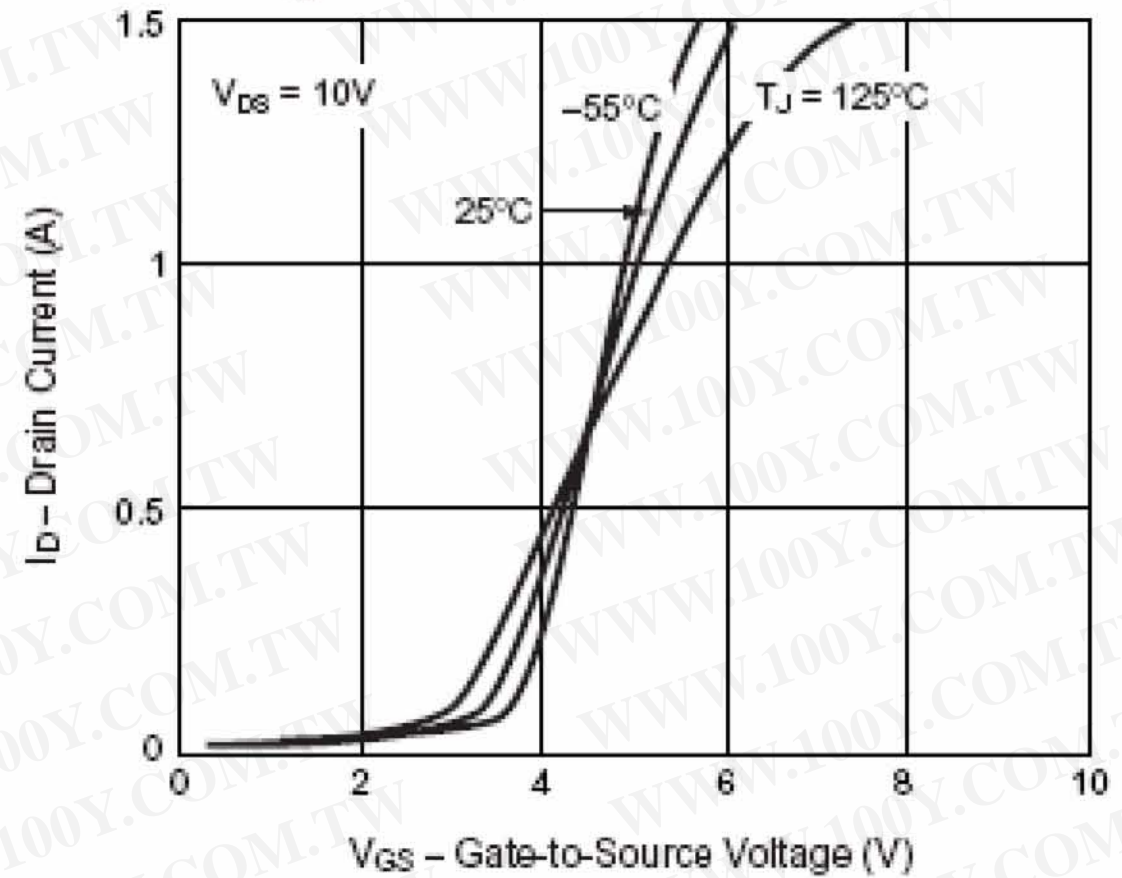

Fig. 5 – Capacitance

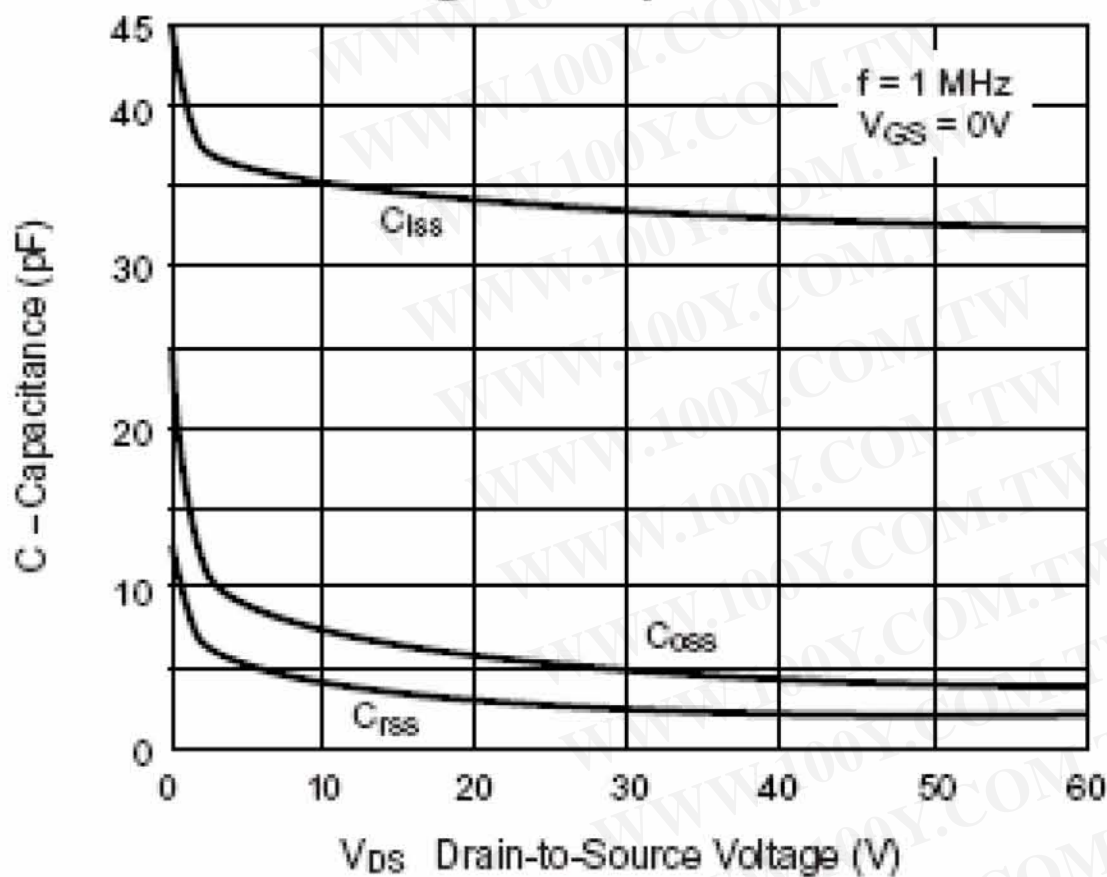
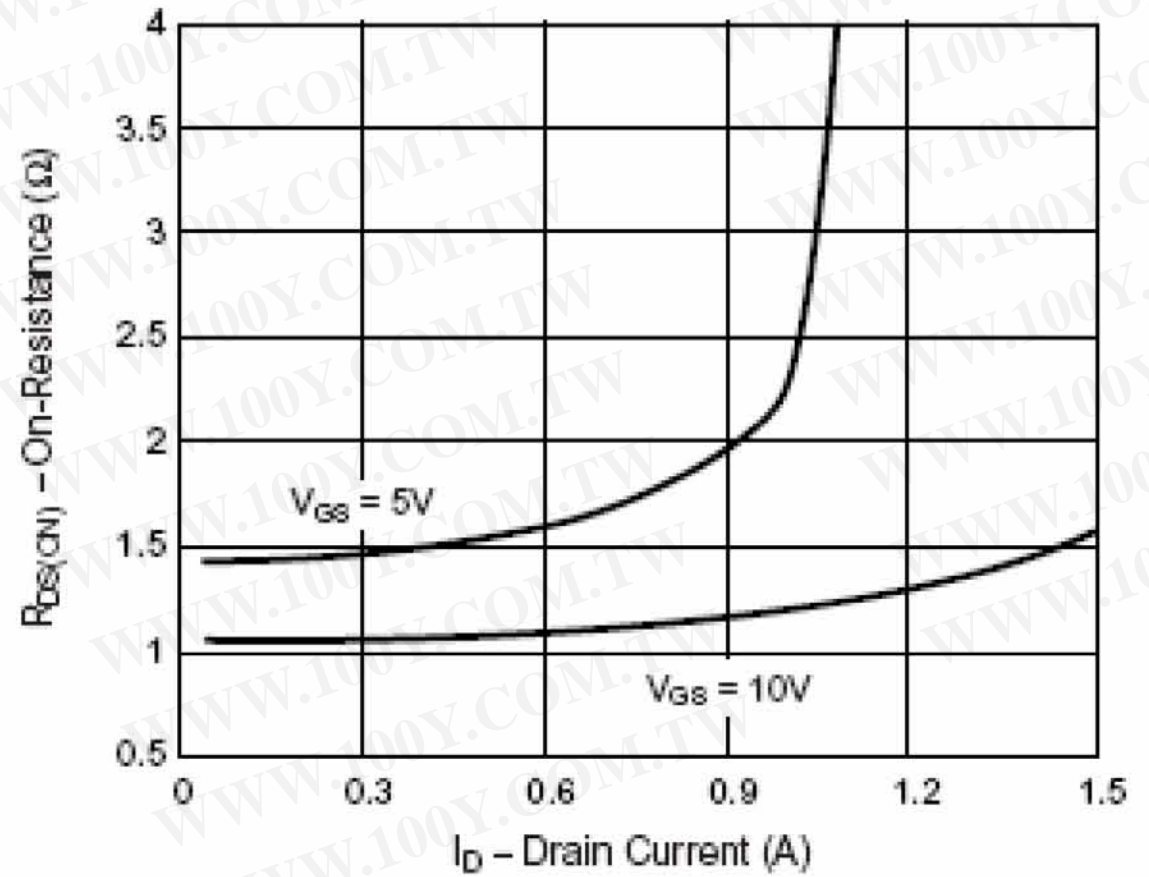

Fig. 6 – On-Resistance vs. Drain Current



# 2N7002

勝特力材料 886-3-5753170  
 勝特力电子(上海) 86-21-34970699  
 勝特力电子(深圳) 86-755-83298787  
[Http://www.100y.com.tw](http://www.100y.com.tw)



Micro Commercial Components

Fig. 7 – Gate Charge

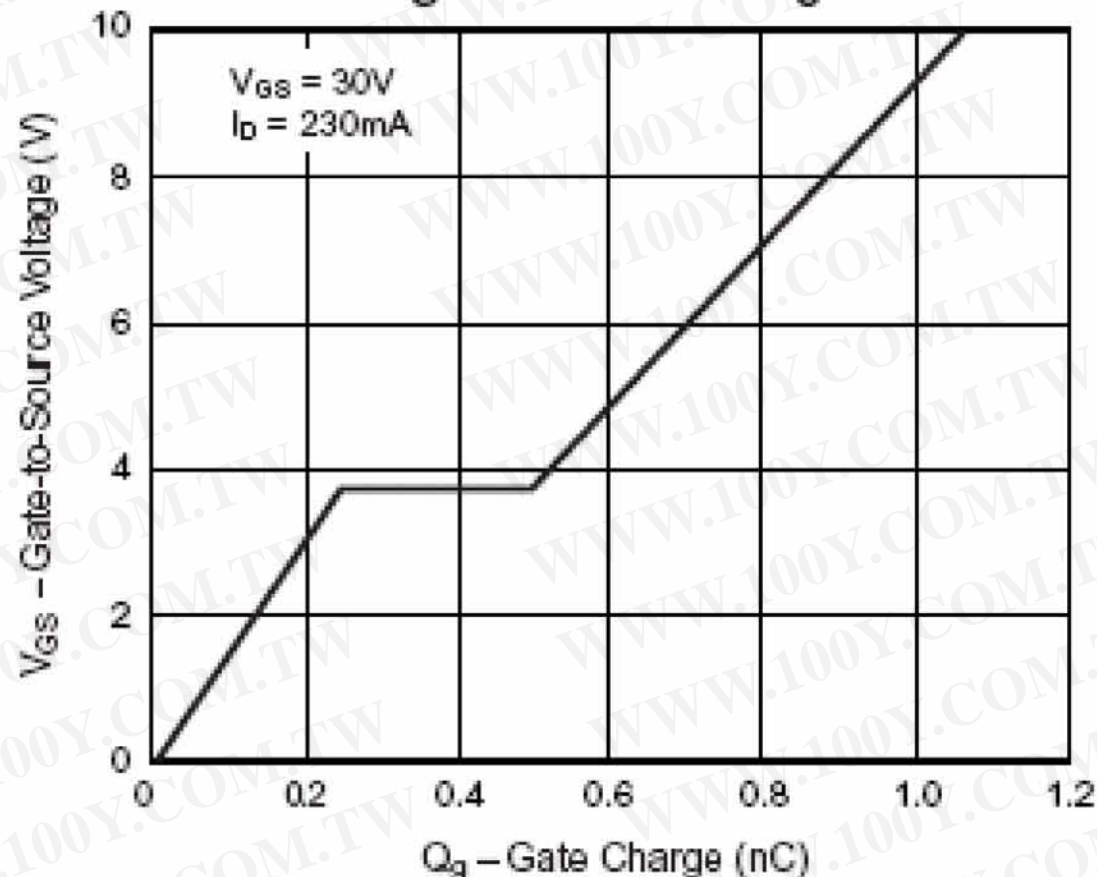

Fig. 8 – Breakdown Voltage vs. Junction Temperature

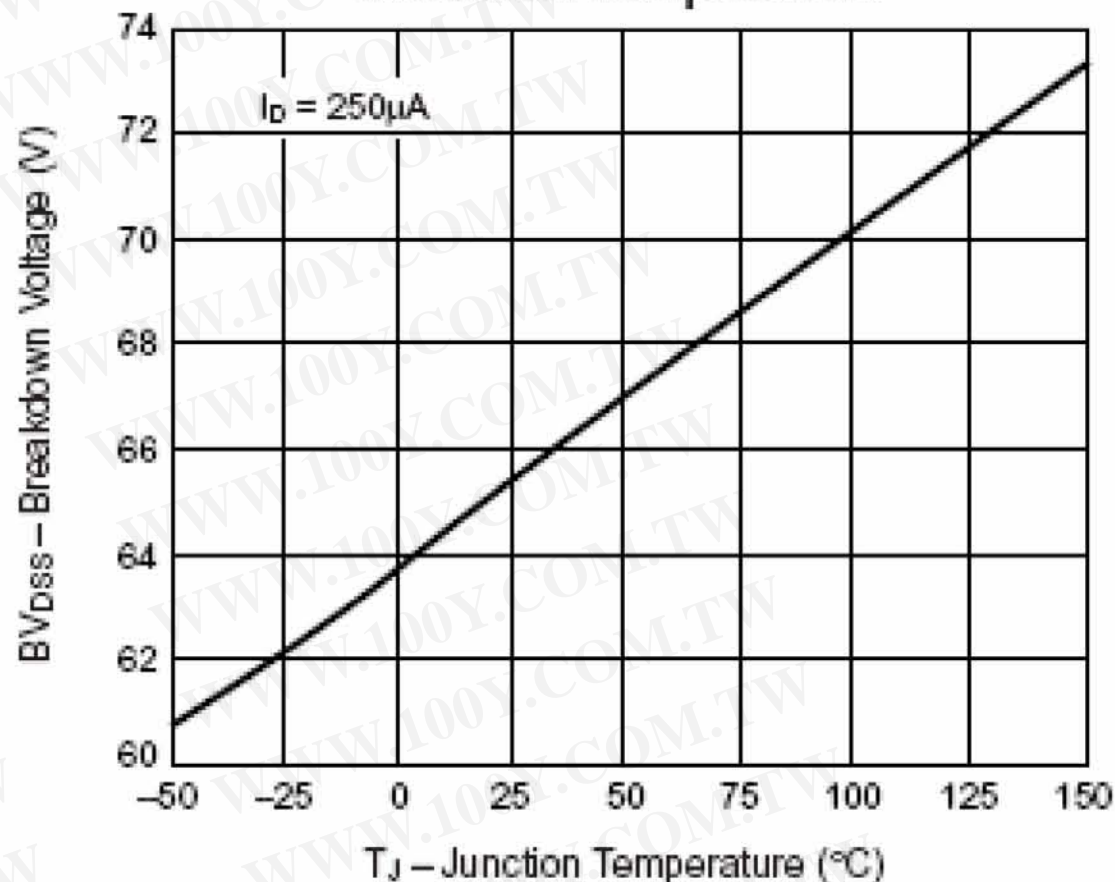

Fig. 9 – Threshold Voltage

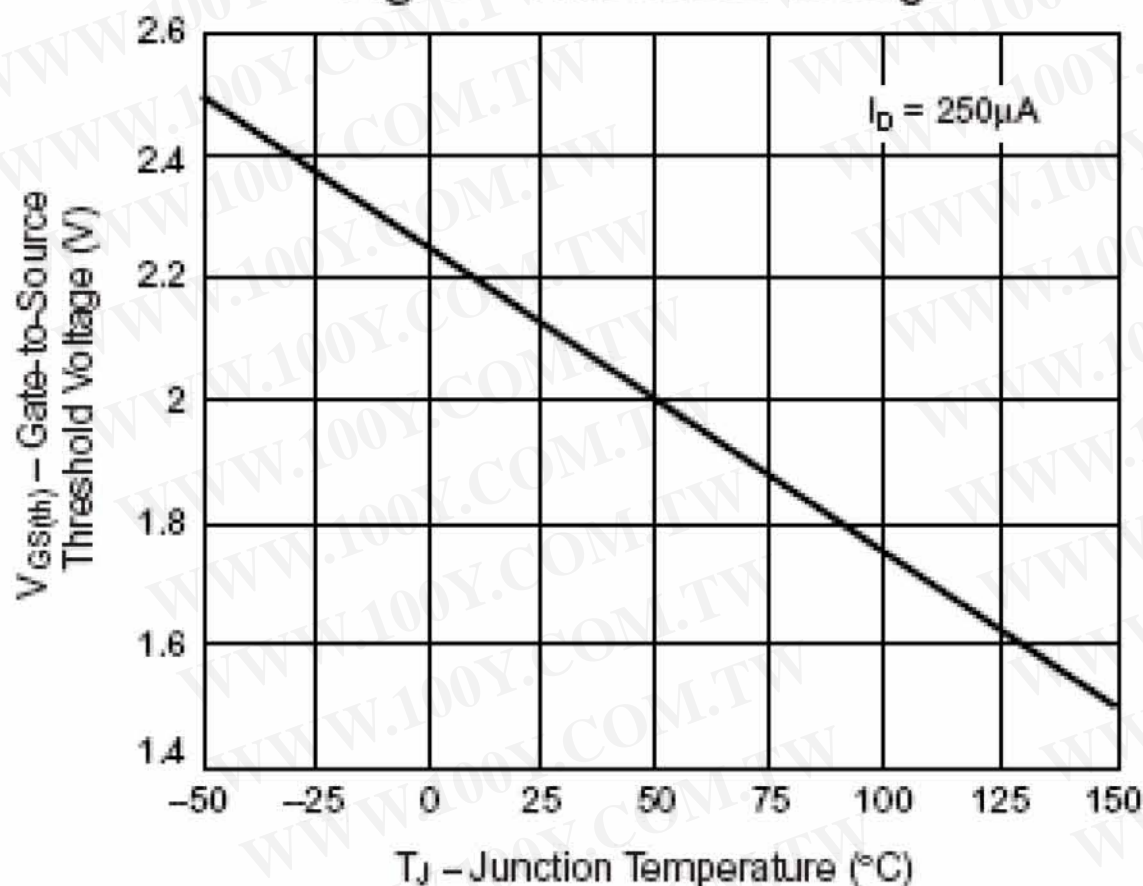

Fig. 10 – On-Resistance vs. Junction Temperature

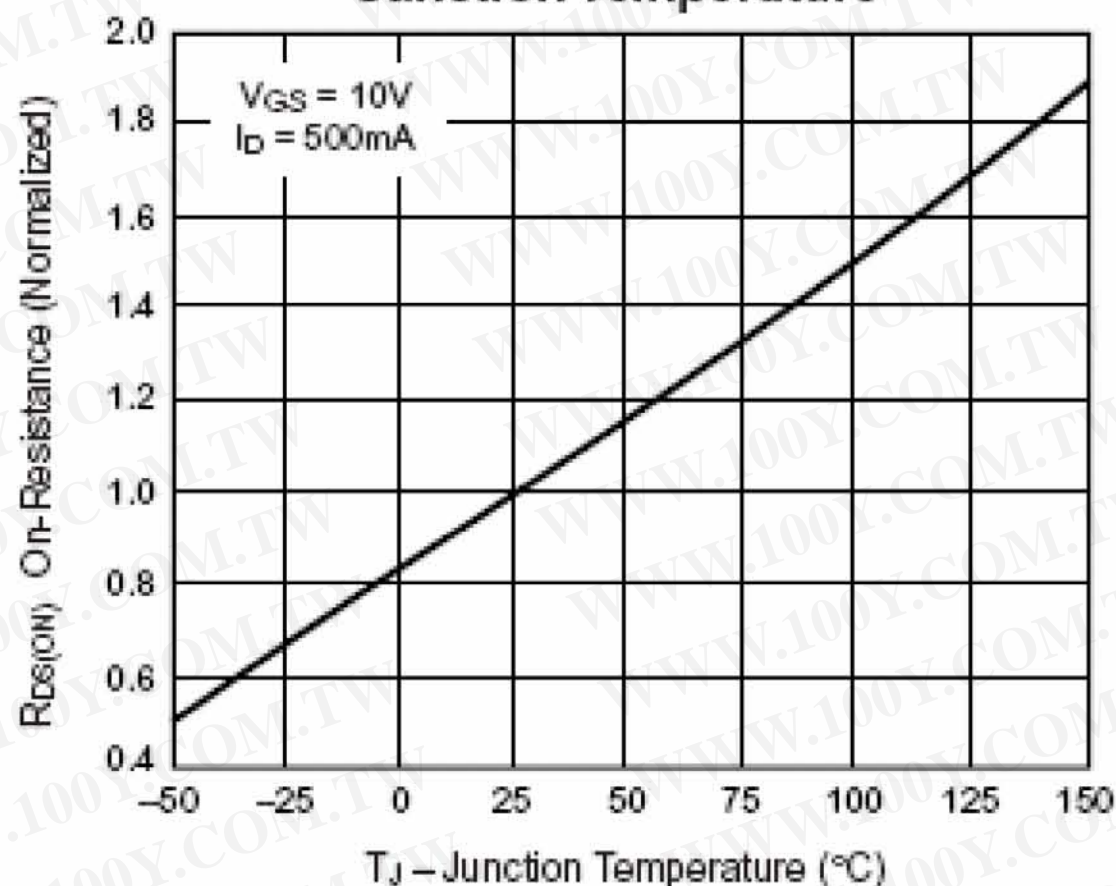

Fig. 11 – Thermal Impedance

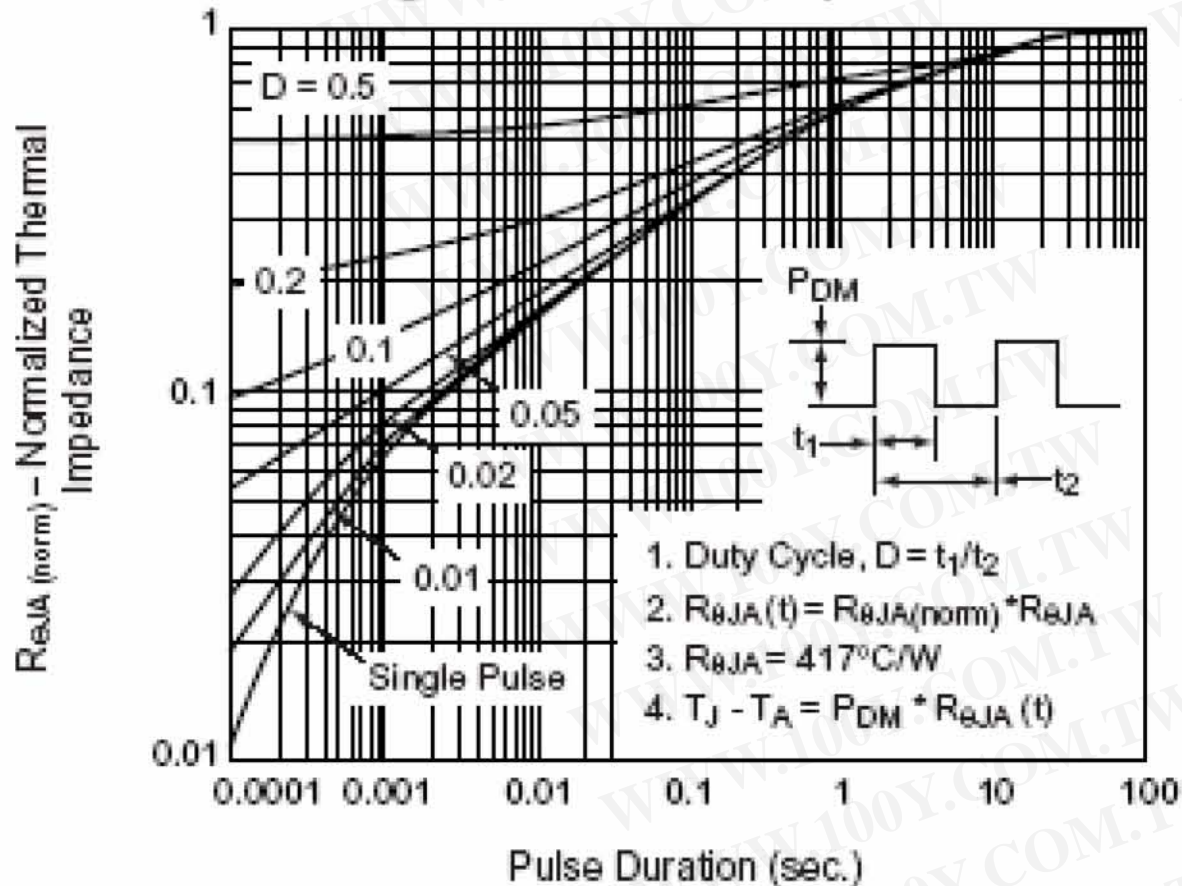
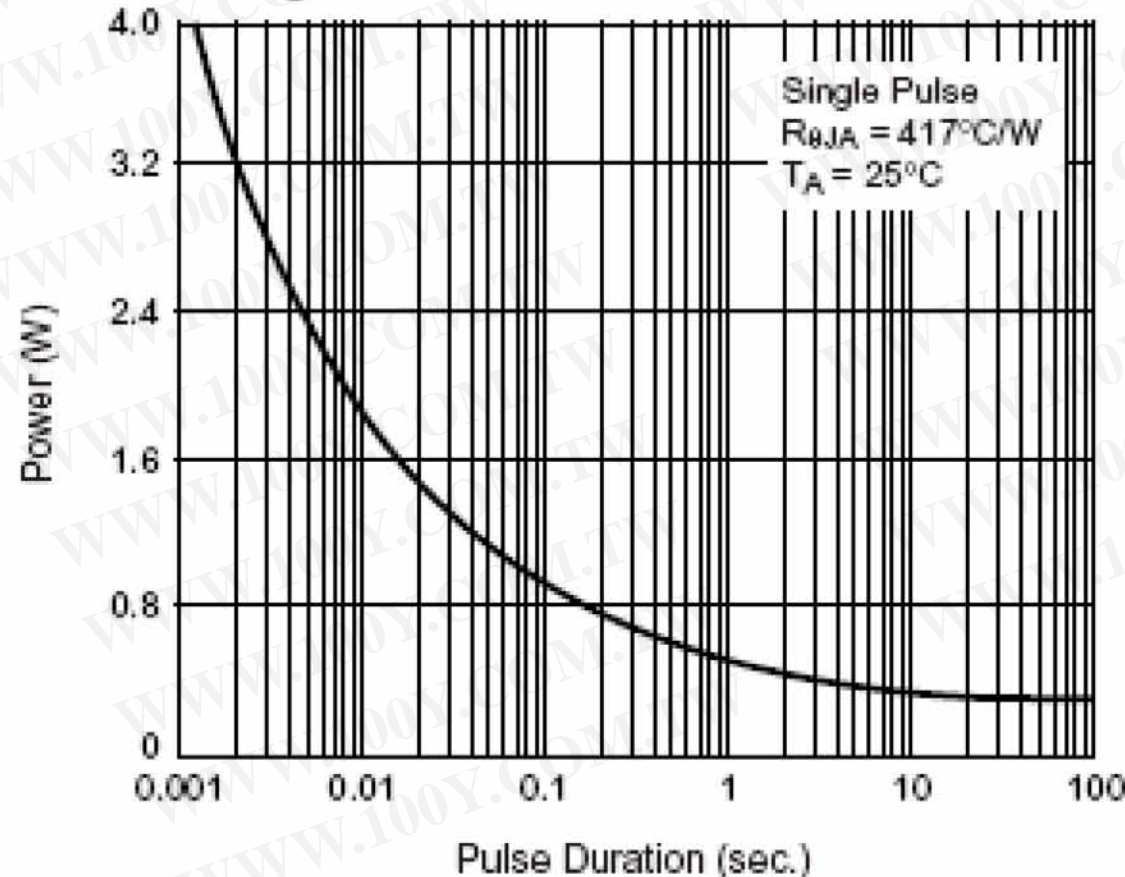
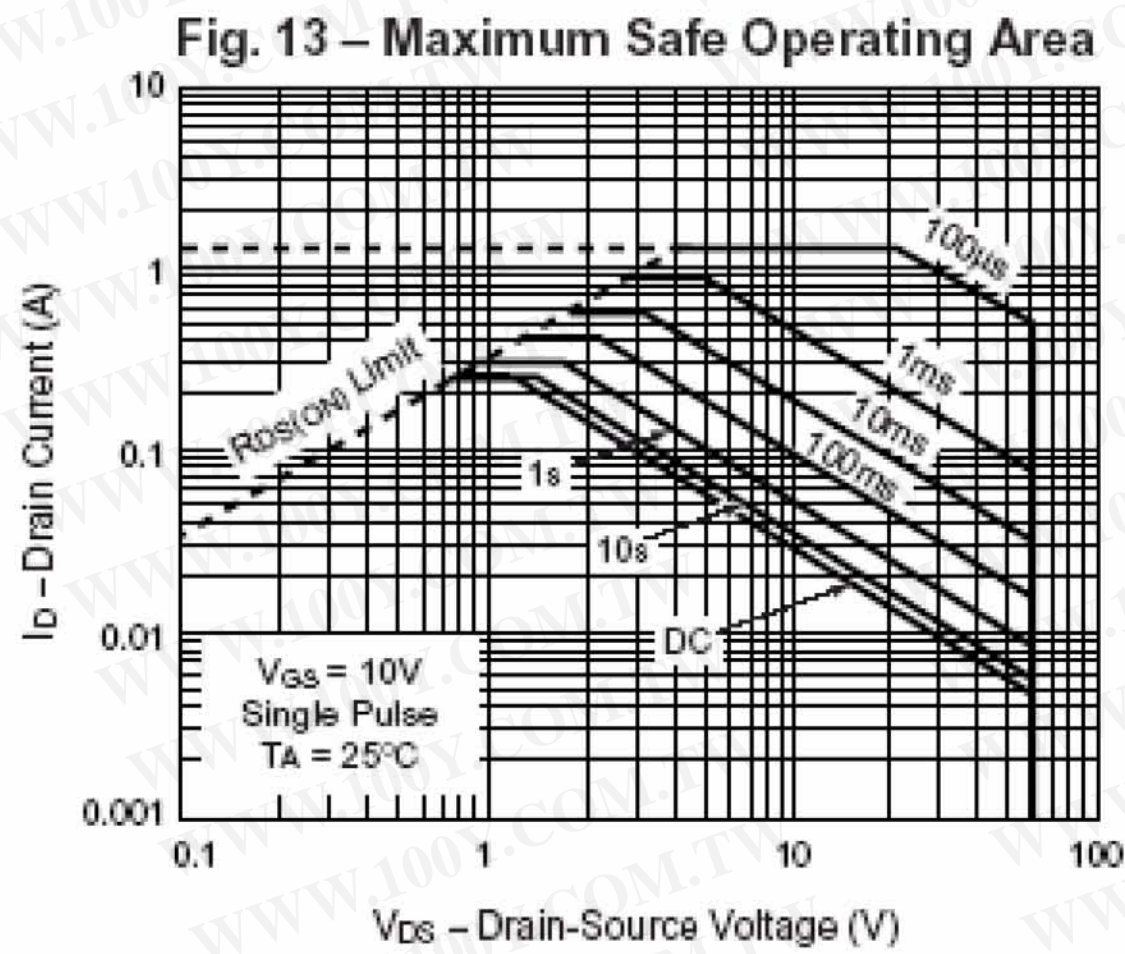

Fig. 12 – Power vs. Pulse Duration





勝特力材料 886-3-5753170  
勝特力电子(上海) 86-21-34970699  
勝特力电子(深圳) 86-755-83298787  
[Http://www.100y.com.tw](http://www.100y.com.tw)



Micro Commercial Components

勝特力材料 886-3-5753170  
勝特力电子(上海) 86-21-34970699  
勝特力电子(深圳) 86-755-83298787  
[Http://www.100y.com.tw](http://www.100y.com.tw)

## Ordering Information

Device	Packing
(Part Number)-TP	Tape&Reel;3Kpcs/Reel

### \*\*\*IMPORTANT NOTICE\*\*\*

*Micro Commercial Components Corp.* reserves the right to make changes without further notice to any product herein to make corrections, modifications, enhancements, improvements, or other changes. *Micro Commercial Components Corp.* does not assume any liability arising out of the application or use of any product described herein; neither does it convey any license under its patent rights, nor the rights of others. The user of products in such applications shall assume all risks of such use and will agree to hold *Micro Commercial Components Corp.* and all the companies whose products are represented on our website, harmless against all damages.

### \*\*\*APPLICATIONS DISCLAIMER\*\*\*

Products offer by *Micro Commercial Components Corp.* are not intended for use in Medical, Aerospace or Military Applications.