

## FCP11N60/FCPF11N60

### General Description

SuperFET™ is a new generation of high voltage MOSFETs from Fairchild with outstanding low on-resistance and low gate charge performance, a result of proprietary technology utilizing advanced charge balance mechanisms.

This advanced technology has been tailored to minimize conduction loss, provide superior switching performance, and withstand extreme dv/dt rate and higher avalanche energy. Consequently, SuperFET is very suitable for various AC/DC power conversion in switching mode operation for system miniaturization and higher efficiency.

### Features

- 650V @ $T_j = 150^\circ\text{C}$
- Typ.  $R_{ds(on)} = 0.32\Omega$
- Ultra low gate charge (typ.  $Q_g = 40\text{nC}$ )
- Low effective output capacitance (typ.  $C_{oss,eff} = 95\text{pF}$ )
- 100% avalanche tested
- RoHS Compliant

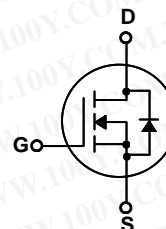
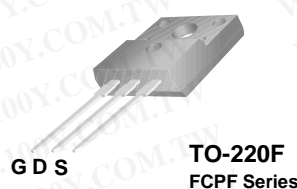
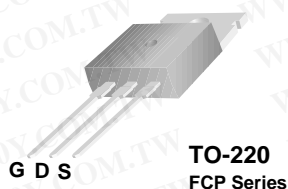

### Absolute Maximum Ratings $T_C = 25^\circ\text{C}$ unless otherwise noted

| Symbol         | Parameter   | FCP11N60    | FCPF11N60 | Units               |
|----------------|---|-------------|-----------|---------------------|
| $I_D$          | Drain Current - Continuous ( $T_C = 25^\circ\text{C}$ )                       | 11          | 11*       | A                   |
|                | - Continuous ( $T_C = 100^\circ\text{C}$ )                                    | 7           | 7*        | A                   |
| $I_{DM}$       | Drain Current - Pulsed (Note 1)   | 33          | 33*       | A                   |
| $V_{GSS}$      | Gate-Source Voltage   | $\pm 30$    |           | V                   |
| $E_{AS}$       | Single Pulsed Avalanche Energy (Note 2)                                       | 340         |           | mJ                  |
| $I_{AR}$       | Avalanche Current (Note 1)  | 11          |           | A                   |
| $E_{AR}$       | Repetitive Avalanche Energy (Note 1)  | 12.5        |           | mJ                  |
| dv/dt          | Peak Diode Recovery dv/dt (Note 3)  | 4.5         |           | V/ns                |
| $P_D$          | Power Dissipation ( $T_C = 25^\circ\text{C}$ )                                | 125         | 36        | W                   |
|                | - Derate above $25^\circ\text{C}$   | 1.0         | 0.29      | W/ $^\circ\text{C}$ |
| $T_J, T_{STG}$ | Operating and Storage Temperature Range                                       | -55 to +150 |           | $^\circ\text{C}$    |
| $T_L$          | Maximum lead temperature for soldering purposes, 1/8" from case for 5 seconds | 300         |           | $^\circ\text{C}$    |

\* Drain current limited by maximum junction temperature

### Thermal Characteristics

| Symbol          | Parameter                               | FCP11N60 | FCPF11N60 | Units                     |
|-----------------|---|----------|-----------|---------------------------|
| $R_{\theta JC}$ | Thermal Resistance, Junction-to-Case    | 1.0      | 3.5       | $^\circ\text{C}/\text{W}$ |
| $R_{\theta CS}$ | Thermal Resistance, Case-to-Sink        | 0.5      | --        | $^\circ\text{C}/\text{W}$ |
| $R_{\theta JA}$ | Thermal Resistance, Junction-to-Ambient | 62.5     | 62.5      | $^\circ\text{C}/\text{W}$ |

## Electrical Characteristics

$T_C = 25^\circ\text{C}$  unless otherwise noted

| Symbol                         | Parameter                                 | Test Conditions  | Min | Typ | Max  | Units                     |
|--------------------------------|---|--|-----|-----|------|---------------------------|
| <b>Off Characteristics</b>     |   |  |     |     |      |                           |
| $BV_{DSS}$                     | Drain-Source Breakdown Voltage            | $V_{GS} = 0\text{ V}, I_D = 250\ \mu\text{A}, T_J = 25^\circ\text{C}$  | 600 | --  | --   | V                         |
|                                |   | $V_{GS} = 0\text{ V}, I_D = 250\ \mu\text{A}, T_J = 150^\circ\text{C}$ | --  | 650 | --   | V                         |
| $\Delta BV_{DSS} / \Delta T_J$ | Breakdown Voltage Temperature Coefficient | $I_D = 250\ \mu\text{A}$ , Referenced to $25^\circ\text{C}$            | --  | 0.6 | --   | $\text{V}/^\circ\text{C}$ |
| $BV_{DS}$                      | Drain-Source Avalanche Breakdown Voltage  | $V_{GS} = 0\text{ V}, I_D = 11\text{ A}$                               | --  | 700 | --   | V                         |
| $I_{DSS}$                      | Zero Gate Voltage Drain Current           | $V_{DS} = 600\text{ V}, V_{GS} = 0\text{ V}$                           | --  | --  | 1    | $\mu\text{A}$             |
|                                |   | $V_{DS} = 480\text{ V}, T_C = 125^\circ\text{C}$                       | --  | --  | 10   | $\mu\text{A}$             |
| $I_{GSSF}$                     | Gate-Body Leakage Current, Forward        | $V_{GS} = 30\text{ V}, V_{DS} = 0\text{ V}$                            | --  | --  | 100  | nA                        |
| $I_{GSSR}$                     | Gate-Body Leakage Current, Reverse        | $V_{GS} = -30\text{ V}, V_{DS} = 0\text{ V}$                           | --  | --  | -100 | nA                        |

### On Characteristics

|              |                                   |   |     |      |      |          |
|--------------|-----------------------------------|---|-----|------|------|----------|
| $V_{GS(th)}$ | Gate Threshold Voltage            | $V_{DS} = V_{GS}, I_D = 250\ \mu\text{A}$           | 3.0 | --   | 5.0  | V        |
| $R_{DS(on)}$ | Static Drain-Source On-Resistance | $V_{GS} = 10\text{ V}, I_D = 5.5\text{ A}$          | --  | 0.32 | 0.38 | $\Omega$ |
| $g_{FS}$     | Forward Transconductance          | $V_{DS} = 40\text{ V}, I_D = 5.5\text{ A}$ (Note 4) | --  | 9.7  | --   | S        |

### Dynamic Characteristics

|                       |                              |   |    |      |      |    |
|-----------------------|------------------------------|---|----|------|------|----|
| $C_{iss}$             | Input Capacitance            | $V_{DS} = 25\text{ V}, V_{GS} = 0\text{ V},$<br>$f = 1.0\text{ MHz}$  | -- | 1148 | 1490 | pF |
| $C_{oss}$             | Output Capacitance           |   | -- | 671  | 870  | pF |
| $C_{riss}$            | Reverse Transfer Capacitance |   | -- | 63   | 82   | pF |
| $C_{oss}$             | Output Capacitance           | $V_{DS} = 480\text{ V}, V_{GS} = 0\text{ V},$<br>$f = 1.0\text{ MHz}$ | -- | 35   | --   | pF |
| $C_{oss\text{ eff.}}$ | Effective Output Capacitance | $V_{DS} = 0\text{ V to } 480\text{ V}, V_{GS} = 0\text{ V}$           | -- | 95   | --   | pF |

### Switching Characteristics

|              |                     |   |             |     |     |     |
|--------------|---------------------|---|-------------|-----|-----|-----|
| $t_{d(on)}$  | Turn-On Delay Time  | $V_{DD} = 300\text{ V}, I_D = 11\text{ A},$<br>$R_G = 25\ \Omega$     | --          | 34  | 80  | ns  |
| $t_r$        | Turn-On Rise Time   |   | --          | 98  | 205 | ns  |
| $t_{d(off)}$ | Turn-Off Delay Time |   | --          | 119 | 250 | ns  |
| $t_f$        | Turn-Off Fall Time  |   | (Note 4, 5) | --  | 56  | 120 |
| $Q_g$        | Total Gate Charge   | $V_{DS} = 480\text{ V}, I_D = 11\text{ A},$<br>$V_{GS} = 10\text{ V}$ | --          | 40  | 52  | nC  |
| $Q_{gs}$     | Gate-Source Charge  |   | --          | 7.2 | --  | nC  |
| $Q_{gd}$     | Gate-Drain Charge   |   | (Note 4, 5) | --  | 21  | --  |

### Drain-Source Diode Characteristics and Maximum Ratings

|          |   |   |    |     |     |               |
|----------|---|---|----|-----|-----|---------------|
| $I_S$    | Maximum Continuous Drain-Source Diode Forward Current | --  | -- | 11  | A   |               |
| $I_{SM}$ | Maximum Pulsed Drain-Source Diode Forward Current     | --  | -- | 33  | A   |               |
| $V_{SD}$ | Drain-Source Diode Forward Voltage                    | $V_{GS} = 0\text{ V}, I_S = 11\text{ A}$        | -- | --  | 1.4 | V             |
| $t_{rr}$ | Reverse Recovery Time                                 | $V_{GS} = 0\text{ V}, I_S = 11\text{ A},$       | -- | 390 | --  | ns            |
| $Q_{rr}$ | Reverse Recovery Charge                               | $di_F / dt = 100\text{ A}/\mu\text{s}$ (Note 4) | -- | 5.7 | --  | $\mu\text{C}$ |

#### Notes:

1. Repetitive Rating : Pulse width limited by maximum junction temperature
2.  $I_{AS} = 5.5\text{ A}, V_{DD} = 50\text{ V}, R_G = 25\ \Omega$ , Starting  $T_J = 25^\circ\text{C}$
3.  $I_{SD} \leq 11\text{ A}, di/dt \leq 200\text{ A}/\mu\text{s}, V_{DD} \leq BV_{DSS}$  Starting  $T_J = 25^\circ\text{C}$
4. Pulse Test : Pulse width  $\leq 300\ \mu\text{s}$ , Duty cycle  $\leq 2\%$
5. Essentially independent of operating temperature

Typical Characteristics

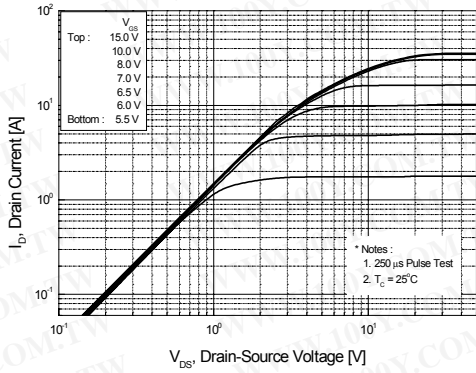

Figure 1. On-Region Characteristics

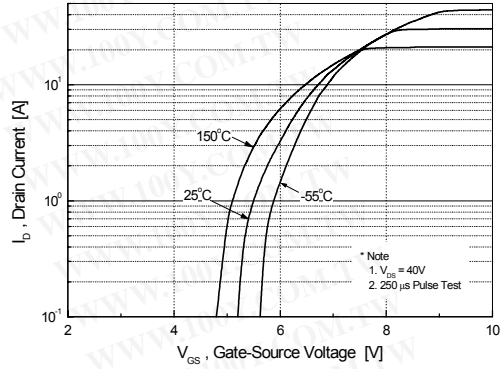

Figure 2. Transfer Characteristics

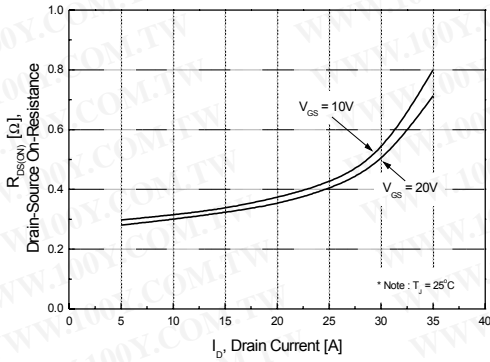

Figure 3. On-Resistance Variation vs. Drain Current and Gate Voltage

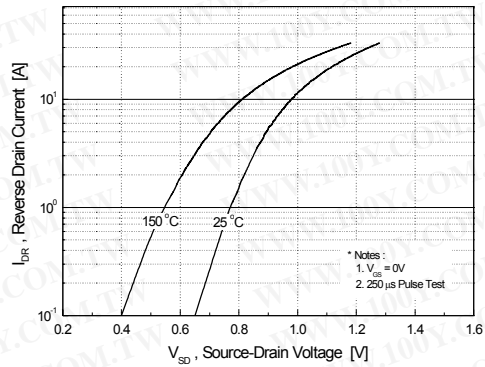

Figure 4. Body Diode Forward Voltage Variation vs. Source Current and Temperature

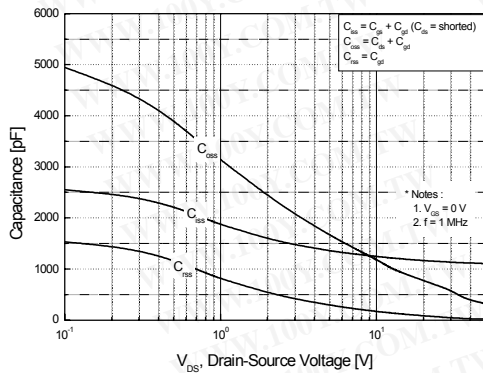

Figure 5. Capacitance Characteristics

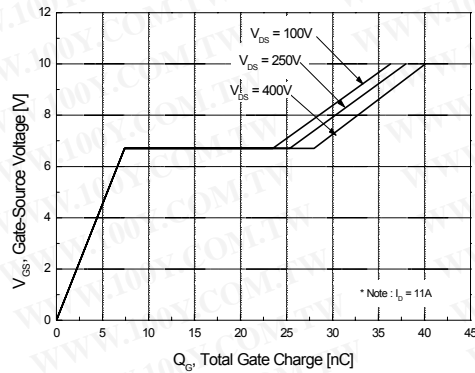

Figure 6. Gate Charge Characteristics

Typical Characteristics (Continued)

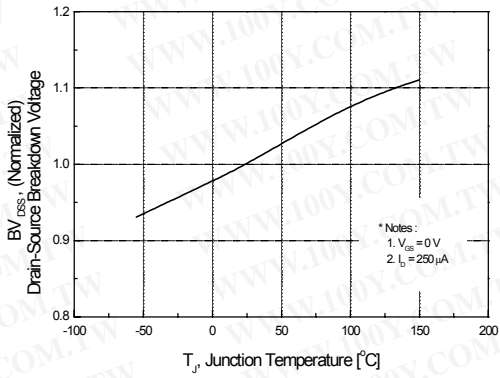

Figure 7. Breakdown Voltage Variation vs. Temperature

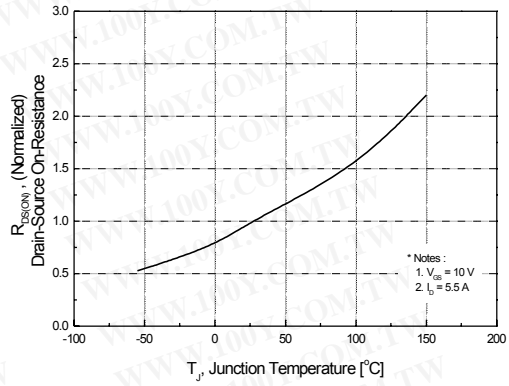

Figure 8. On-Resistance Variation vs. Temperature

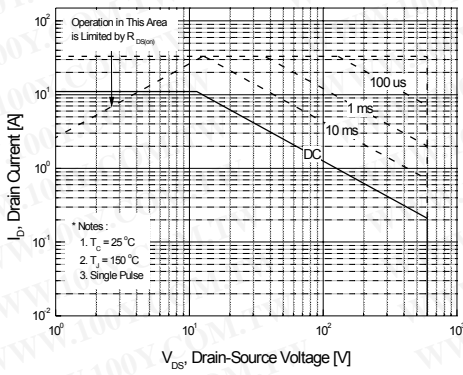

Figure 9-1. Maximum Safe Operating Area for FCP11N60

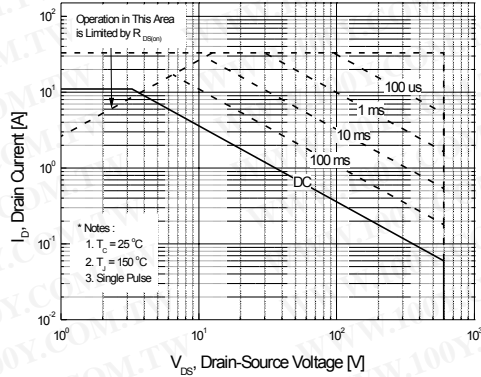

Figure 9-2. Maximum Safe Operating Area for FCPF11N60

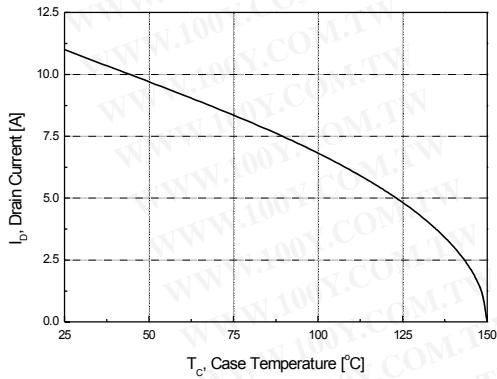

Figure 10. Maximum Drain Current vs. Case Temperature

Typical Characteristics (Continued)

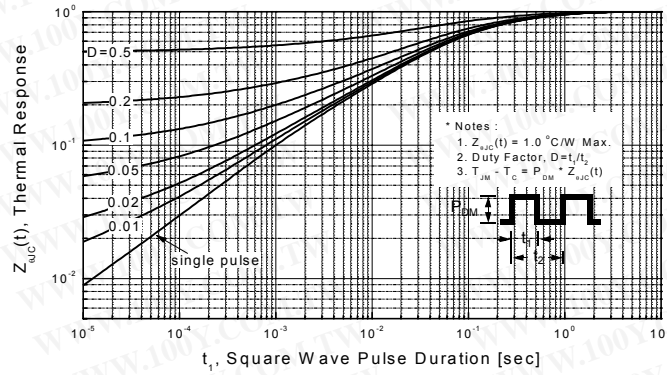

Figure 11-1. Transient Thermal Response Curve for FCP11N60

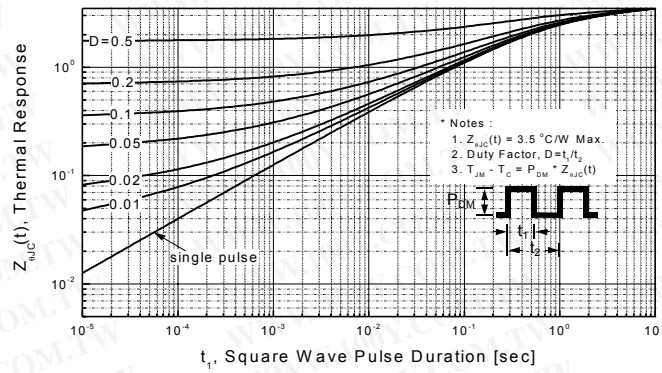
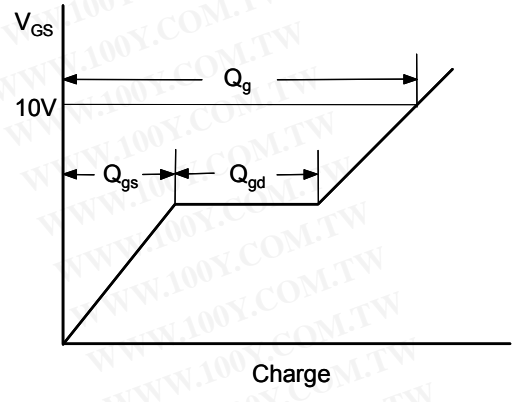
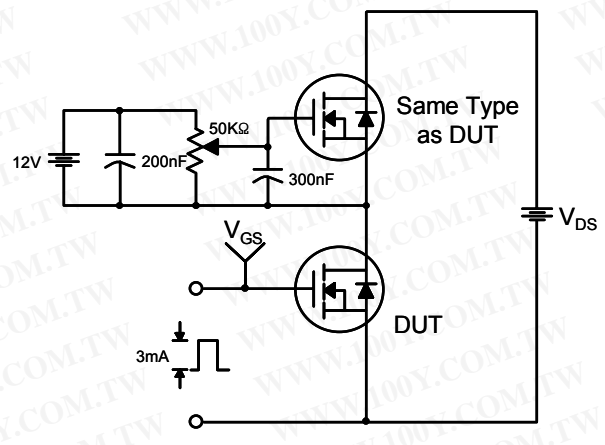
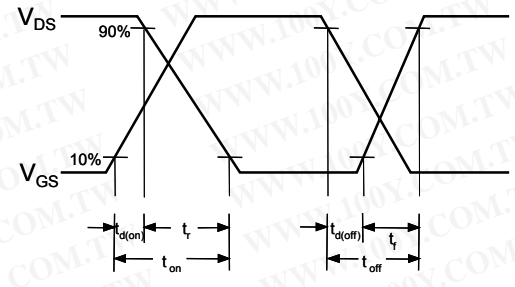
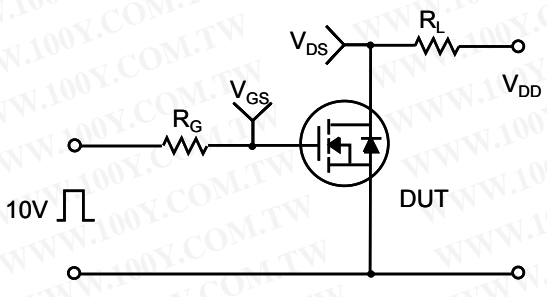

Figure 11-2. Transient Thermal Response Curve for FCPF11N60

Gate Charge Test Circuit & Waveform



Resistive Switching Test Circuit & Waveforms



Unclamped Inductive Switching Test Circuit & Waveforms

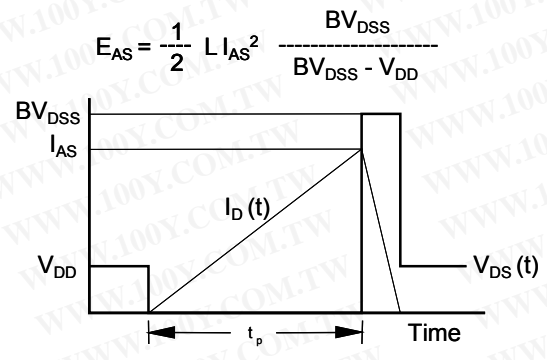
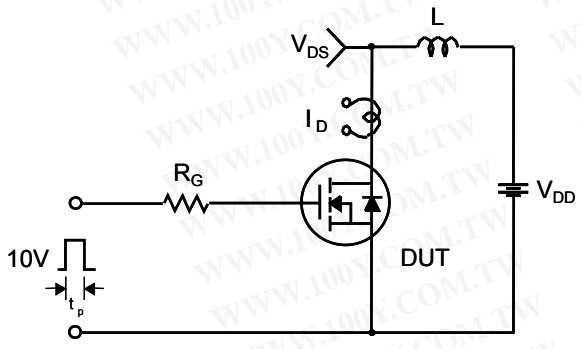

Peak Diode Recovery dv/dt Test Circuit & Waveforms

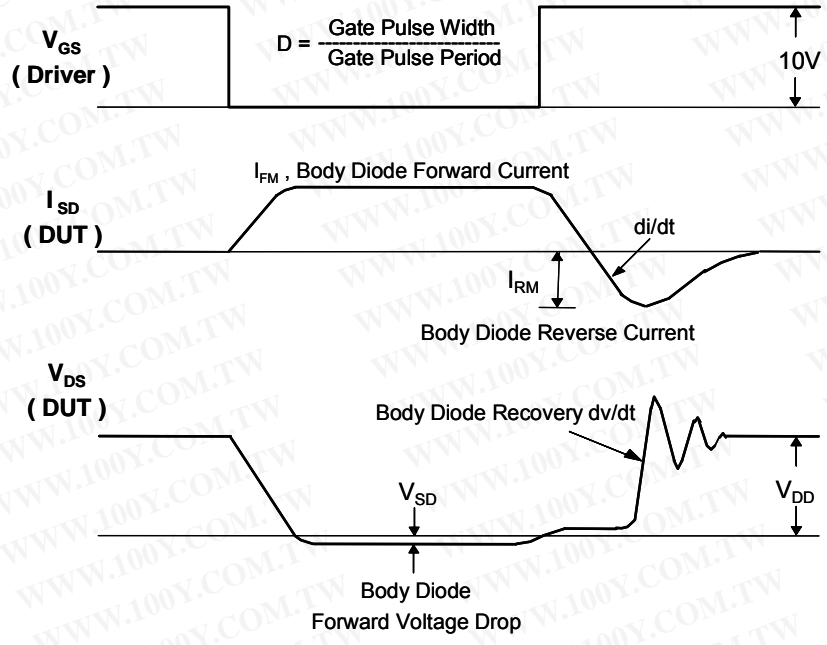
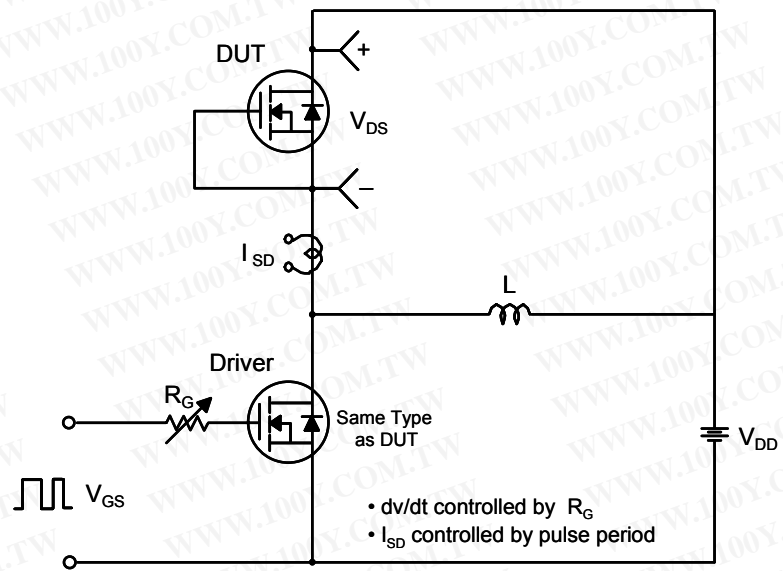



# Package Dimensions

## TO-220F

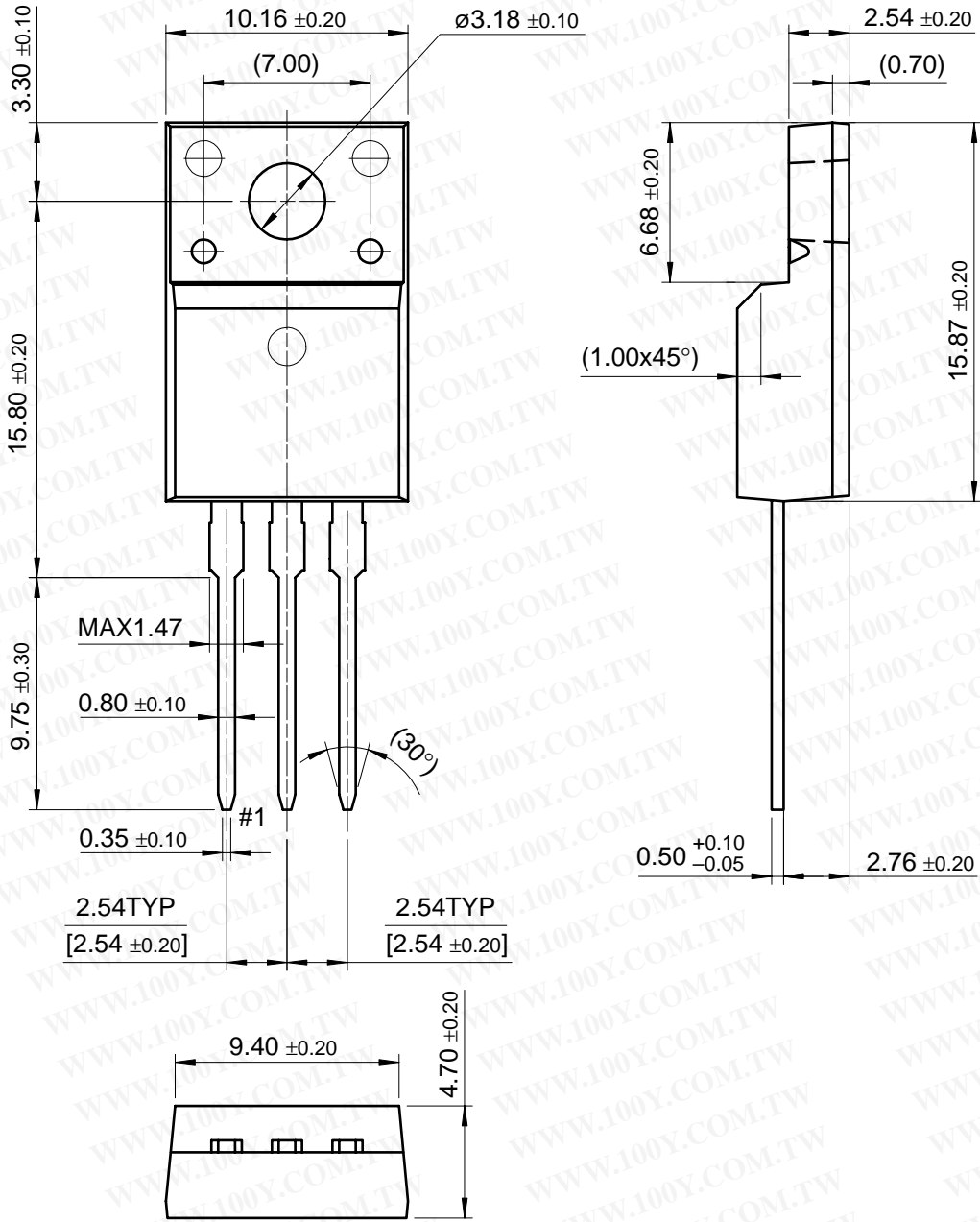

FCP11N60/FCPF11N60

Dimensions in Millimeters

**TRADEMARKS**

The following includes registered and unregistered trademarks and service marks, owned by Fairchild Semiconductor and/or its global subsidiaries, and is not intended to be an exhaustive list of all such trademarks.

- |   |   |   |   |
|---|---|---|---|
| Build it Now™   | FRFET®  | Programmable Active Droop™  | the power franchise   |
| CorePLUS™   | Global Power Resource <sup>SM</sup>   | QFET®   | TinyBoost™  |
| CorePOWER™  | Green FPS™  | QS™   | TinyBuck™   |
| CROSSVOLT™  | Green FPS™ e-Series™  | Quiet Series™   | TinyLogic®  |
| CTL™  | GTO™  | RapidConfigure™   | TINYOPTO™   |
| Current Transfer Logic™   | IntelliMAX™   |  ™ | TinyPower™  |
| EcoSPARK®   | ISOPLANAR™  | Saving our world, 1mW /W /kW at a time™   | TinyPWM™  |
| EfficientMax™   | MegaBuck™   | SmartMax™   | TinyWire™   |
| EZSWITCH™ *   | MICROCOUPLER™   | SMART START™  | μSerDes™  |
|  ™ | MicroFET™   | SPM®  |  |
|  ™ | MicroPak™   | STEALTH™  | UHC®  |
| Fairchild®  | MillerDrive™  | SuperFET™   | Ultra FRFET™  |
| Fairchild Semiconductor®  | MotionMax™  | SuperSOT™-3   | UniFET™   |
| FACT Quiet Series™  | Motion-SPM™   | SuperSOT™-6   | VCX™  |
| FACT®   | OPTOLOGIC®  | SuperSOT™-8   | VisualMax™  |
| FACT®   | OPTOPLANAR®   | SupreMOS™   | XS™   |
| FAST®   |  | SyncFET™  |   |
| FastvCore™  | PDP SPM™  |  ™ |   |
| FlashWriter® *  | Power-SPM™  | The Power Franchise®  |   |
| FPS™  | PowerTrench®  |   |   |
| F-PFS™  | PowerXS™  |   |   |

\* EZSWITCH™ and FlashWriter® are trademarks of System General Corporation, used under license by Fairchild Semiconductor.

**DISCLAIMER**

FAIRCHILD SEMICONDUCTOR RESERVES THE RIGHT TO MAKE CHANGES WITHOUT FURTHER NOTICE TO ANY PRODUCTS HEREIN TO IMPROVE RELIABILITY, FUNCTION, OR DESIGN. FAIRCHILD DOES NOT ASSUME ANY LIABILITY ARISING OUT OF THE APPLICATION OR USE OF ANY PRODUCT OR CIRCUIT DESCRIBED HEREIN; NEITHER DOES IT CONVEY ANY LICENSE UNDER ITS PATENT RIGHTS, NOR THE RIGHTS OF OTHERS. THESE SPECIFICATIONS DO NOT EXPAND THE TERMS OF FAIRCHILD'S WORLDWIDE TERMS AND CONDITIONS, SPECIFICALLY THE WARRANTY THEREIN, WHICH COVERS THESE PRODUCTS.

**LIFE SUPPORT POLICY**

FAIRCHILD'S PRODUCTS ARE NOT AUTHORIZED FOR USE AS CRITICAL COMPONENTS IN LIFE SUPPORT DEVICES OR SYSTEMS WITHOUT THE EXPRESS WRITTEN APPROVAL OF FAIRCHILD SEMICONDUCTOR CORPORATION.

As used herein:

- Life support devices or systems are devices or systems which, (a) are intended for surgical implant into the body or (b) support or sustain life, and (c) whose failure to perform when properly used in accordance with instructions for use provided in the labeling, can be reasonably expected to result in a significant injury of the user.
- A critical component in any component of a life support, device, or system whose failure to perform can be reasonably expected to cause the failure of the life support device or system, or to affect its safety or effectiveness.

**ANTI-COUNTERFEITING POLICY**

Fairchild Semiconductor Corporation's Anti-Counterfeiting Policy. Fairchild's Anti-Counterfeiting Policy is also stated on our external website, www.fairchildsemi.com, under Sales Support.

Counterfeiting of semiconductor parts is a growing problem in the industry. All manufactures of semiconductor products are experiencing counterfeiting of their parts. Customers who inadvertently purchase counterfeit parts experience many problems such as loss of brand reputation, substandard performance, failed application, and increased cost of production and manufacturing delays. Fairchild is taking strong measures to protect ourselves and our customers from the proliferation of counterfeit parts. Fairchild strongly encourages customers to purchase Fairchild parts either directly from Fairchild or from Authorized Fairchild Distributors who are listed by country on our web page cited above. Products customers buy either from fairchild directly or from Authorized Fairchild Distributors are genuine parts, have full traceability, meet Fairchild's quality standards for handling and storage and provide access to Fairchild's full range of up-to-date technical and product information. Fairchild and our Authorized Distributors will stand behind all warranties and will appropriately address and warranty issues that may arise. Fairchild will not provide any warranty coverage or other assistance for parts bought from Unauthorized Sources. Fairchild is committed to combat this global problem and encourage our customers to do their part in stopping this practice by buying direct or from authorized distributors.

**PRODUCT STATUS DEFINITIONS**

**Definition of Terms**

| Datasheet Identification | Product Status        | Definition  |
|--------------------------|-----------------------|---|
| Advance Information      | Formative / In Design | Datasheet contains the design specifications for product development. Specifications may change in any manner without notice.   |
| Preliminary              | First Production      | Datasheet contains preliminary data; supplementary data will be published at a later date. Fairchild Semiconductor reserves the right to make changes at any time without notice to improve design. |
| No Identification Needed | Full Production       | Datasheet contains final specifications. Fairchild Semiconductor reserves the right to make changes at any time without notice to improve the design.   |
| Obsolete                 | Not In Production     | Datasheet contains specifications on a product that is discontinued by Fairchild Semiconductor. The datasheet is for reference information only.  |

Rev. I37