

Features

- Ultra Low Forward Voltage Drop
- Superior Reverse Avalanche Capability
- Patented Interlocking Clip Design for High Surge Current Capacity
- Patented Super Barrier Rectifier Technology
- Soft, Fast Switching Capability
- 150°C Operating Junction Temperature
- ±16KV ESD Protection (HBM, 3B)
- ±25KV ESD Protection (IEC61000-4-2 Level 4, Air Discharge)
- **Lead Free Finish, RoHS Compliant (Note 1)**
- **“Green” Molding Compound (No Br, Sb)**
- **Qualified to AEC-Q 101 Standards for High Reliability**

Mechanical Data

- Case: POWERDI[®]123
- Case Material: Molded Plastic, “Green” Molding Compound. UL Flammability Classification Rating 94V-0
- Moisture Sensitivity: Level 1 per J-STD-020
- Polarity Indicator: Cathode Band
- Terminals: Matte Tin Finish annealed over Copper leadframe. Solderable per MIL-STD-202, Method 208 ☞
- Weight: 0.018 grams (approximate)

 POWERDI[®]123

Top View

勝特力材料 886-3-5753170
 勝特力电子(上海) 86-21-34970699
 勝特力电子(深圳) 86-755-83298787
[Http://www.100y.com.tw](http://www.100y.com.tw)

Ordering Information (Note 2)

Part Number	Case	Packaging
SBR2U30P1-7	POWERDI [®] 123	3000/Tape & Reel

- Notes:
1. EU Directive 2002/95/EC (RoHS) & 2011/65/EU (RoHS 2). All applicable RoHS exemptions applied
 2. For packaging details, go to our website at <http://www.diodes.com>.

Marking Information



2U3 = Product Type Marking Code
 YM = Date Code Marking
 Y = Year (ex: T = 2006)
 M = Month (ex: 9 = September)

Date Code Key

Year	2006	2007	2008	2009	2010	2011	2012	2013	2014	2015	2016	2017
Code	T	U	V	W	X	Y	Z	A	B	C	D	E
Month	Jan	Feb	Mar	Apr	May	Jun	Jul	Aug	Sep	Oct	Nov	Dec
Code	1	2	3	4	5	6	7	8	9	O	N	D

SBR and POWERDI are registered trademarks of Diodes Incorporated.

Maximum Ratings @T_A = 25°C unless otherwise specified

Single phase, half wave, 60Hz, resistive or inductive load.
For capacitance load, derate current by 20%.

Characteristic	Symbol	Value	Unit
Peak Repetitive Reverse Voltage	V _{RRM}	30	V
Working Peak Reverse Voltage	V _{RWM}		
DC Blocking Voltage	V _{RM}		
RMS Reverse Voltage	V _{R(RMS)}	21	V
Average Rectified Output Current (See Figure 1)	I _O	2.0	A
Non-Repetitive Peak Forward Surge Current 8.3ms Single Half Sine-Wave Superimposed on Rated Load	I _{FSM}	75	A
Non-Repetitive Avalanche Energy (T _J = 25°C, I _{AS} = 5A, L = 8.5 mH)	E _{AS}	105	mJ
Repetitive Peak Avalanche Energy (T _P = 1μs, T _J = 25°C)	P _{ARM}	1100	W

Thermal Characteristics

Characteristic	Symbol	Value	Unit
Maximum Thermal Resistance			
Thermal Resistance Junction to Soldering (Note 3)	R _{θJS}	5	°C/W
Thermal Resistance Junction to Ambient (Note 4)	R _{θJA}	178	
Thermal Resistance Junction to Ambient (Note 5)	R _{θJA}	123	
Operating and Storage Temperature Range	T _J , T _{STG}	-65 to +150	°C

Electrical Characteristics @T_A = 25°C unless otherwise specified

Characteristic	Symbol	Min	Typ	Max	Unit	Test Condition
Reverse Breakdown Voltage (Note 6)	V _{(BR)R}	30	-	-	V	I _R = 400μA
Forward Voltage Drop	V _F	-	0.22	0.26	V	I _F = 0.1A, T _J = 25°C
		-	0.31	0.35		I _F = 1.0A, T _J = 25°C
		-	0.36	0.40		I _F = 2.0A, T _J = 25°C
		-	0.12	0.15		I _F = 0.1A, T _J = 125°C
		-	0.27	0.30		I _F = 1.0A, T _J = 125°C
		-	0.30	0.33		I _F = 2.0A, T _J = 125°C
Leakage Current (Note 6)	I _R	-	75	150	μA	V _R = 5V, T _J = 25°C
		-	150	400	μA	V _R = 30V, T _J = 25°C
		-	6	15	mA	V _R = 5V, T _J = 125°C
		-	12	20	mA	V _R = 30V, T _J = 125°C

- Notes:
3. Theoretical R_{θJS} calculated from the top center of the die straight down to the PCB cathode tab solder junction.
 4. FR-4 PCB, 2 oz. Copper, minimum recommended pad layout per <http://www.diodes.com/datasheets/ap02001.pdf>.
 5. Polyimide PCB, 2 oz. Copper, minimum recommended pad layout per <http://www.diodes.com/datasheets/ap02001.pdf>.
 6. Short duration pulse test used to minimize self-heating effect.

勝特力材料 886-3-5753170
 勝特力电子(上海) 86-21-34970699
 勝特力电子(深圳) 86-755-83298787
[Http://www.100y.com.tw](http://www.100y.com.tw)

SBR and POWERDI are registered trademarks of Diodes Incorporated.

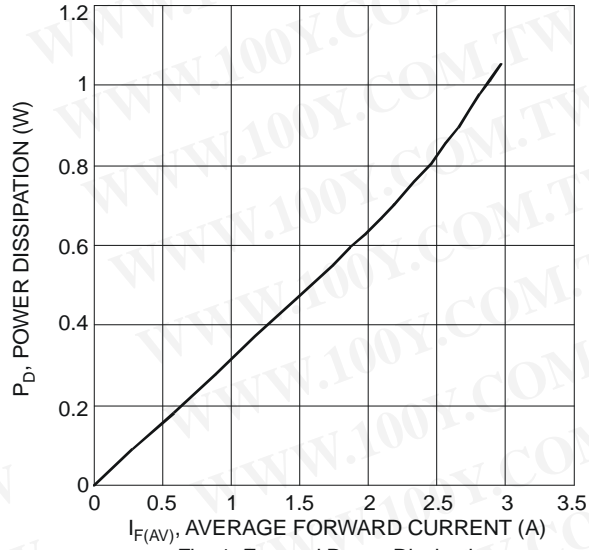

Fig. 1 Forward Power Dissipation

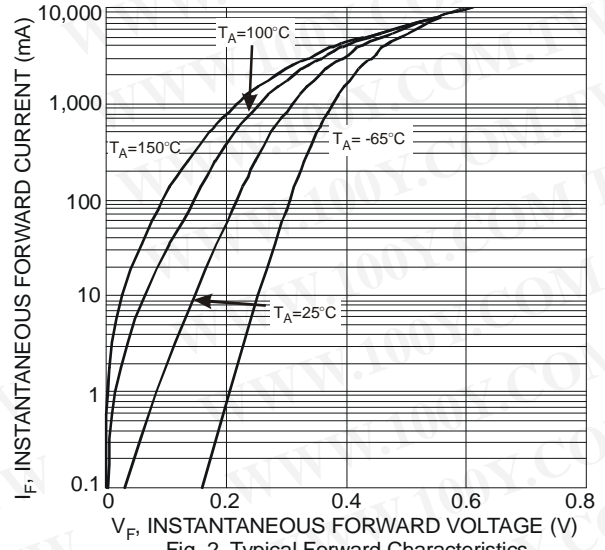

Fig. 2 Typical Forward Characteristics

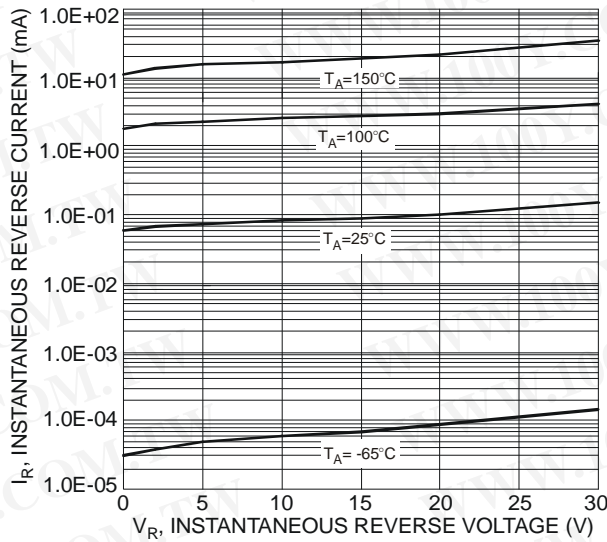

Fig. 3 Typical Reverse Characteristics

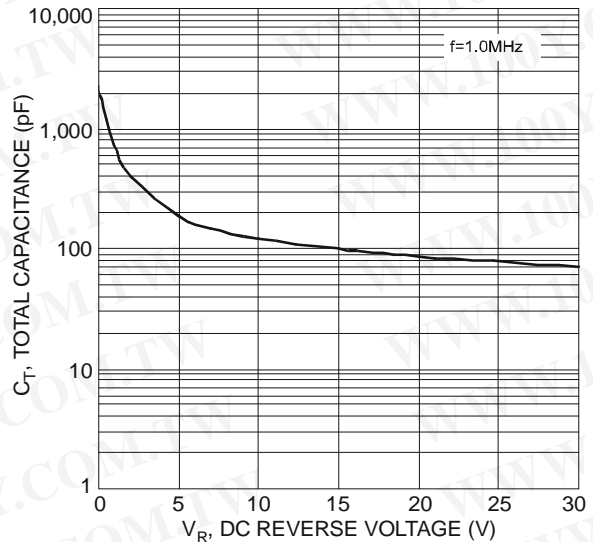

Fig. 4 Total Capacitance vs. Reverse Voltage

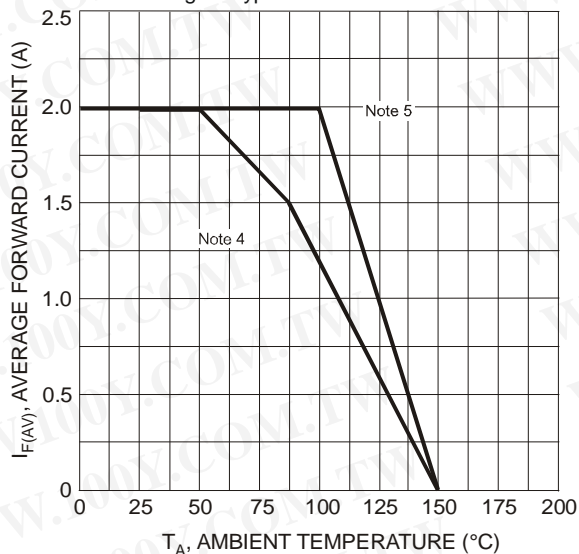

Fig. 5 Forward Current Derating Curve

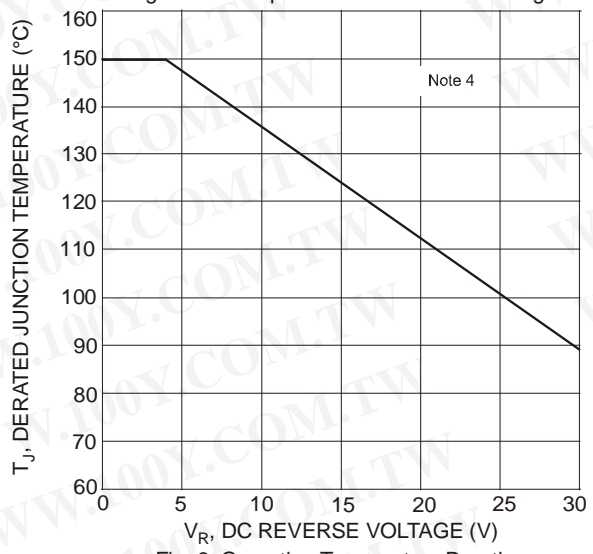

Fig. 6 Operating Temperature Derating

SBR and POWERDI are registered trademarks of Diodes Incorporated.

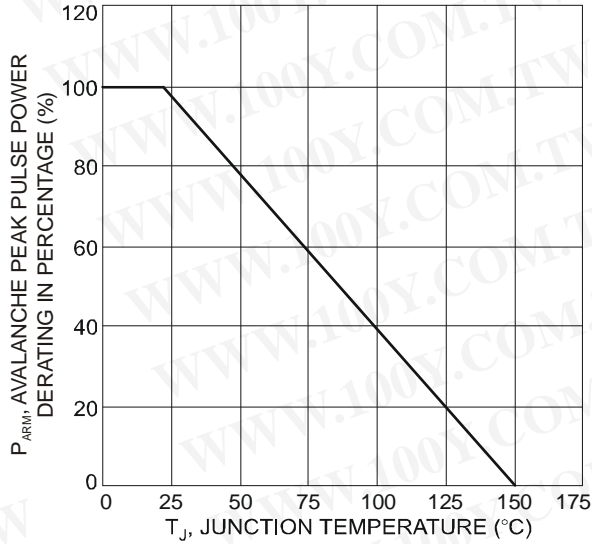

Fig. 7 Pulse Derating Curve

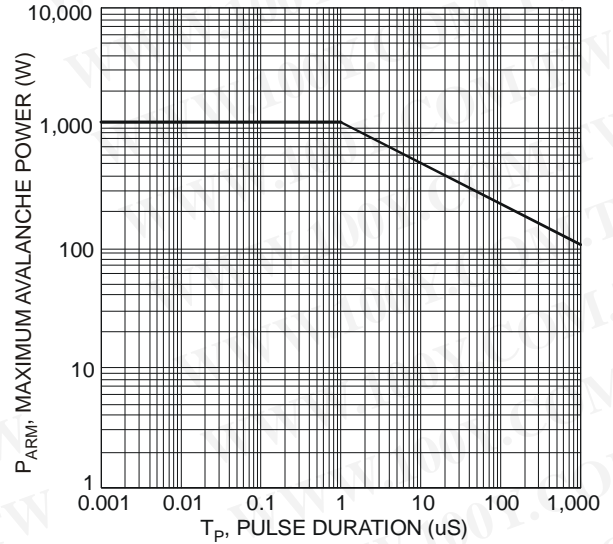

Fig. 8 Maximum Avalanche Power Curve

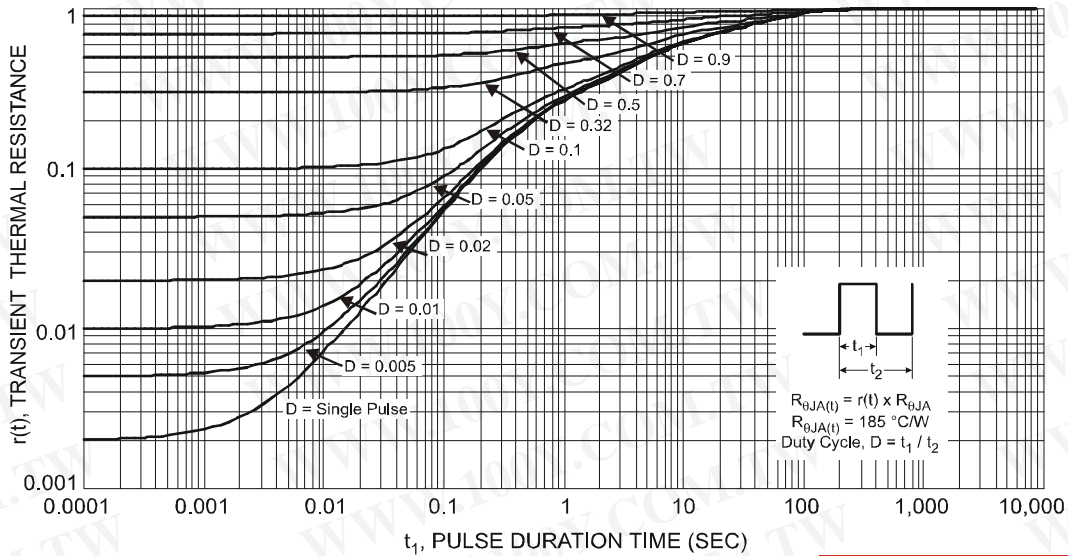
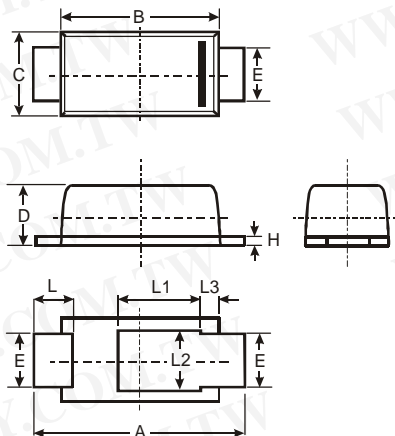

Fig. 9 Transient Thermal Resistance

勝特力材料 886-3-5753170
 勝特力电子(上海) 86-21-34970699
 勝特力电子(深圳) 86-755-83298787
[Http://www.100y.com.tw](http://www.100y.com.tw)

Package Outline Dimensions



POWERDI®123			
Dim	Min	Max	Typ
A	3.50	3.90	3.70
B	2.60	3.00	2.80
C	1.63	1.93	1.78
D	0.93	1.00	0.98
E	0.85	1.25	1.00
H	0.15	0.25	0.20
L	0.40	0.50	0.45
L1	-	-	1.35
L2	-	-	1.10
L3	-	-	0.20
All Dimensions in mm			

SBR and POWERDI are registered trademarks of Diodes Incorporated.

Suggested Pad Layout

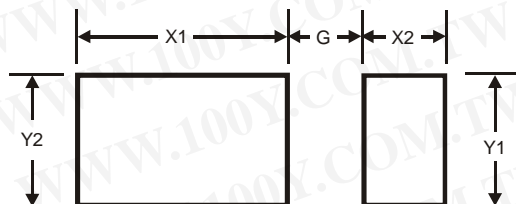

Dimensions	Value (in mm)
G	1.0
X1	2.2
X2	0.9
Y1	1.4
Y2	1.4

IMPORTANT NOTICE

DIODES INCORPORATED MAKES NO WARRANTY OF ANY KIND, EXPRESS OR IMPLIED, WITH REGARDS TO THIS DOCUMENT, INCLUDING, BUT NOT LIMITED TO, THE IMPLIED WARRANTIES OF MERCHANTABILITY AND FITNESS FOR A PARTICULAR PURPOSE (AND THEIR EQUIVALENTS UNDER THE LAWS OF ANY JURISDICTION).

Diodes Incorporated and its subsidiaries reserve the right to make modifications, enhancements, improvements, corrections or other changes without further notice to this document and any product described herein. Diodes Incorporated does not assume any liability arising out of the application or use of this document or any product described herein; neither does Diodes Incorporated convey any license under its patent or trademark rights, nor the rights of others. Any Customer or user of this document or products described herein in such applications shall assume all risks of such use and will agree to hold Diodes Incorporated and all the companies whose products are represented on Diodes Incorporated website, harmless against all damages.

Diodes Incorporated does not warrant or accept any liability whatsoever in respect of any products purchased through unauthorized sales channel. Should Customers purchase or use Diodes Incorporated products for any unintended or unauthorized application, Customers shall indemnify and hold Diodes Incorporated and its representatives harmless against all claims, damages, expenses, and attorney fees arising out of, directly or indirectly, any claim of personal injury or death associated with such unintended or unauthorized application.

Products described herein may be covered by one or more United States, international or foreign patents pending. Product names and markings noted herein may also be covered by one or more United States, international or foreign trademarks.

LIFE SUPPORT

Diodes Incorporated products are specifically not authorized for use as critical components in life support devices or systems without the express written approval of the Chief Executive Officer of Diodes Incorporated. As used herein:

A. Life support devices or systems are devices or systems which:

1. are intended to implant into the body, or
2. support or sustain life and whose failure to perform when properly used in accordance with instructions for use provided in the labeling can be reasonably expected to result in significant injury to the user.

B. A critical component is any component in a life support device or system whose failure to perform can be reasonably expected to cause the failure of the life support device or to affect its safety or effectiveness.

Customers represent that they have all necessary expertise in the safety and regulatory ramifications of their life support devices or systems, and acknowledge and agree that they are solely responsible for all legal, regulatory and safety-related requirements concerning their products and any use of Diodes Incorporated products in such safety-critical, life support devices or systems, notwithstanding any devices- or systems-related information or support that may be provided by Diodes Incorporated. Further, Customers must fully indemnify Diodes Incorporated and its representatives against any damages arising out of the use of Diodes Incorporated products in such safety-critical, life support devices or systems.

Copyright © 2012, Diodes Incorporated

www.diodes.com