

Absolute Maximum Ratings

Symbol	Parameter	Rating	Unit	
Common Ratings ($T_A=25^{\circ}\text{C}$ Unless Otherwise Noted)				
V_{DSS}	Drain-Source Voltage	20	V	
V_{GSS}	Gate-Source Voltage	± 16		
T_{J}	Maximum Junction Temperature	150	$^{\circ}\text{C}$	
T_{STG}	Storage Temperature Range	-55 to 150	$^{\circ}\text{C}$	
I_{S}	Diode Continuous Forward Current	$T_{\text{C}}=25^{\circ}\text{C}$ 3.5	A	
Mounted on Large Heat Sink				
I_{DP}	300 μs Pulse Drain Current Tested	$T_{\text{C}}=25^{\circ}\text{C}$	30	A
		$T_{\text{C}}=100^{\circ}\text{C}$	15	
I_{D}	Continuous Drain Current	$T_{\text{C}}=25^{\circ}\text{C}$	10*	A
		$T_{\text{C}}=100^{\circ}\text{C}$	6	
P_{D}	Maximum Power Dissipation	$T_{\text{C}}=25^{\circ}\text{C}$	50	W
		$T_{\text{C}}=100^{\circ}\text{C}$	20	
$R_{\theta\text{JC}}$	Thermal Resistance-Junction to Case	2.5	$^{\circ}\text{C}/\text{W}$	
Mounted on PCB of 1in² Pad Area				
I_{DP}	300 μs Pulse Drain Current Tested	$T_{\text{A}}=25^{\circ}\text{C}$	30	A
		$T_{\text{A}}=100^{\circ}\text{C}$	15	
I_{D}	Continuous Drain Current	$T_{\text{A}}=25^{\circ}\text{C}$	2	A
		$T_{\text{A}}=100^{\circ}\text{C}$	1	
P_{D}	Maximum Power Dissipation	$T_{\text{A}}=25^{\circ}\text{C}$	2.5	W
		$T_{\text{A}}=100^{\circ}\text{C}$	1	
$R_{\theta\text{JA}}$	Thermal Resistance-Junction to Ambient	50	$^{\circ}\text{C}/\text{W}$	
Mounted on PCB of Minimum Footprint				
I_{DP}	300 μs Pulse Drain Current Tested	$T_{\text{A}}=25^{\circ}\text{C}$	30	A
		$T_{\text{A}}=100^{\circ}\text{C}$	15	
I_{D}	Continuous Drain Current	$T_{\text{A}}=25^{\circ}\text{C}$	2	A
		$T_{\text{A}}=100^{\circ}\text{C}$	1	
P_{D}	Maximum Power Dissipation	$T_{\text{A}}=25^{\circ}\text{C}$	1.6	W
		$T_{\text{A}}=100^{\circ}\text{C}$	0.6	
$R_{\theta\text{JA}}$	Thermal Resistance-Junction to Ambient	75	$^{\circ}\text{C}/\text{W}$	

Note:

* Current limited by bond wire.

Electrical Characteristics (T_A = 25°C unless otherwise noted)

Symbol	Parameter	Test Condition	APM2055NU			Unit
			Min.	Typ.	Max.	
Static Characteristics						
BV _{DSS}	Drain-Source Breakdown Voltage	V _{GS} =0V, I _{DS} =250μA	20			V
I _{DSS}	Zero Gate Voltage Drain Current	V _{DS} =16V, V _{GS} =0V T _J =85°C			1 30	μA
V _{GS(th)}	Gate Threshold Voltage	V _{DS} =V _{GS} , I _{DS} =250μA	0.6	0.9	1.5	V
I _{GSS}	Gate Leakage Current	V _{GS} =±16V, V _{DS} =0V			±100	nA
R _{DS(ON)} ^a	Drain-Source On-state Resistance	V _{GS} =10V, I _{DS} =12A		55	70	mΩ
		V _{GS} =4.5V, I _{DS} =6A		75	90	
		V _{GS} =2.5V, I _{DS} =2A		140	160	
Diode Characteristics						
V _{SD} ^a	Diode Forward Voltage	I _{SD} =2A, V _{GS} =0V		0.7	1.3	V
Dynamic Characteristics^b						
R _G	Gate Resistance	V _{GS} =0V, V _{DS} =0V, F=1MHz		2.5		Ω
C _{iss}	Input Capacitance	V _{GS} =0V, V _{DS} =15V, Frequency=1.0MHz		380		pF
C _{oss}	Output Capacitance			120		
C _{rss}	Reverse Transfer Capacitance			75		
t _{d(ON)}	Turn-on Delay Time	V _{DD} =10V, R _L =10Ω, I _{DS} =1A, V _{GEN} =4.5V, R _G =6Ω		5	8	ns
T _r	Turn-on Rise Time			13	23	
t _{d(OFF)}	Turn-off Delay Time			16	24	
T _f	Turn-off Fall Time			3	5	
Gate Charge Characteristics^b						
Q _g	Total Gate Charge	V _{DS} =10V, V _{GS} =4.5V, I _{DS} =12A		5.4	7	nC
Q _{gs}	Gate-Source Charge			1.4		
Q _{gd}	Gate-Drain Charge			1.7		

Notes:

a : Pulse test ; pulse width≤300μs, duty cycle≤2%.

b : Guaranteed by design, not subject to production testing.

Typical Characteristics

Power Dissipation

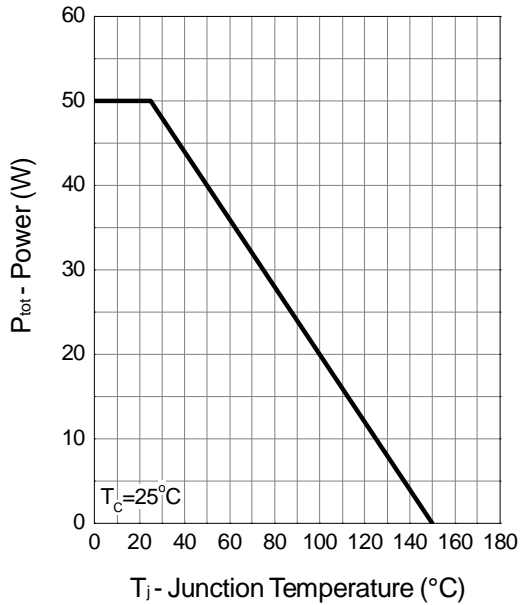

Drain Current

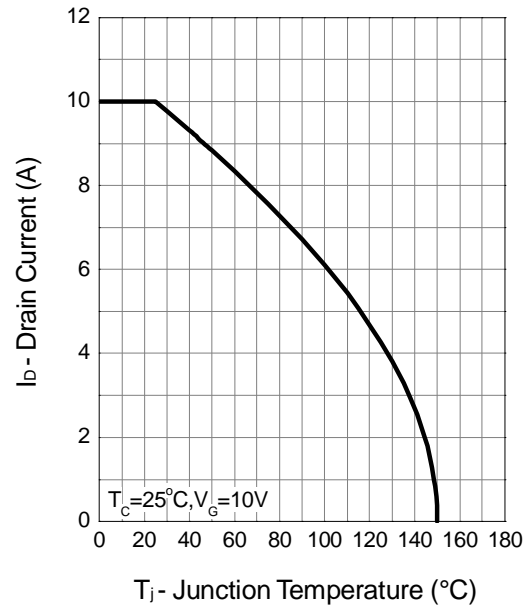

Safe Operation Area

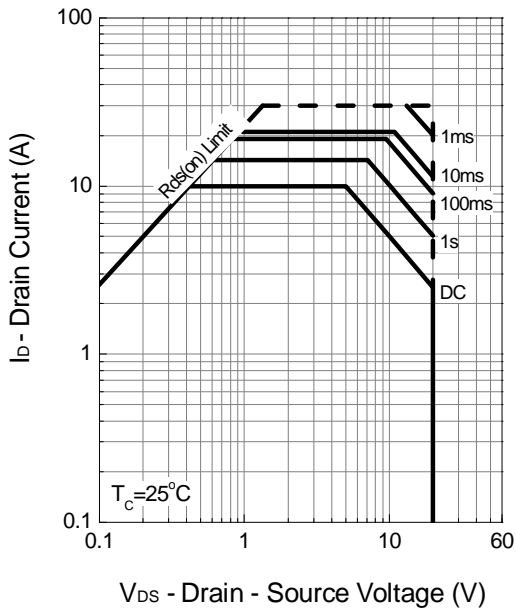

Thermal Transient Impedance

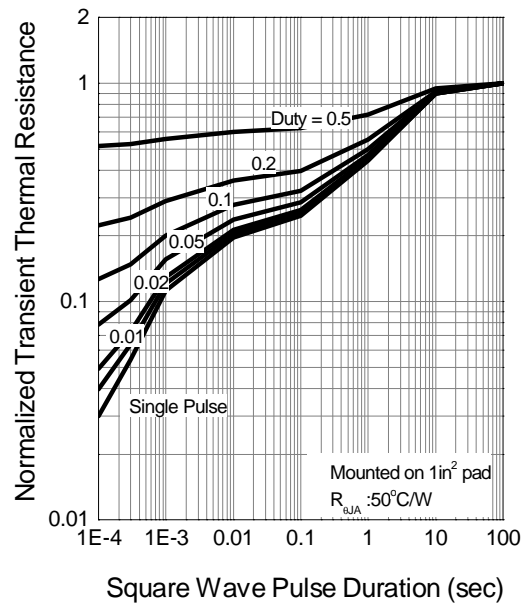

Typical Characteristics (Cont.)

Output Characteristics

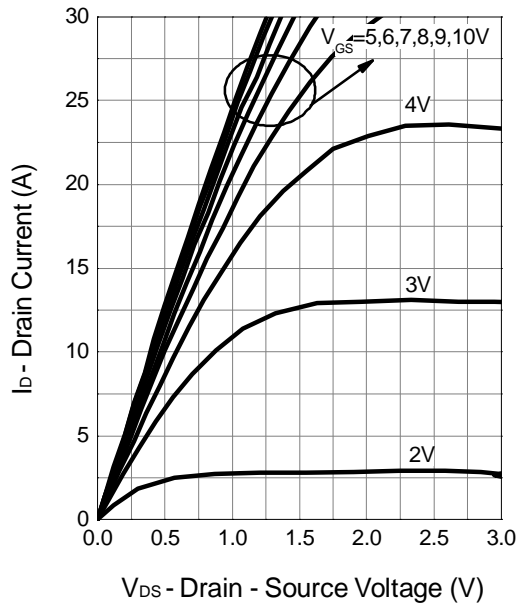

Drain-Source On Resistance

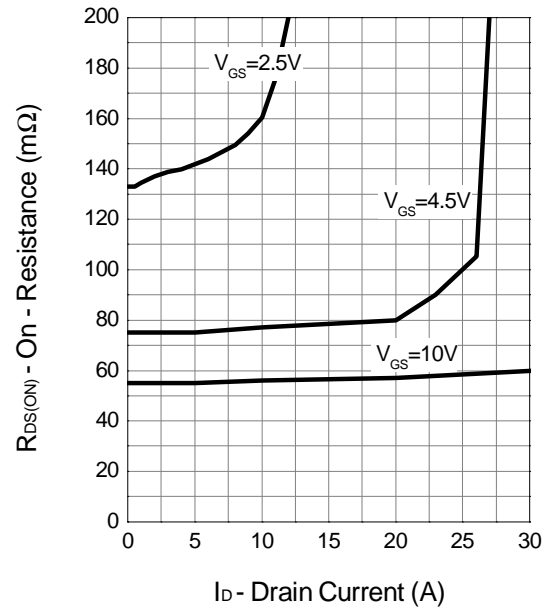

Transfer Characteristics

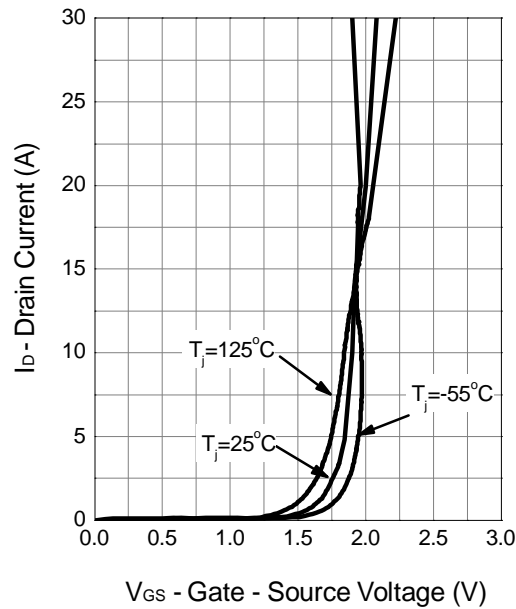

Gate Threshold Voltage

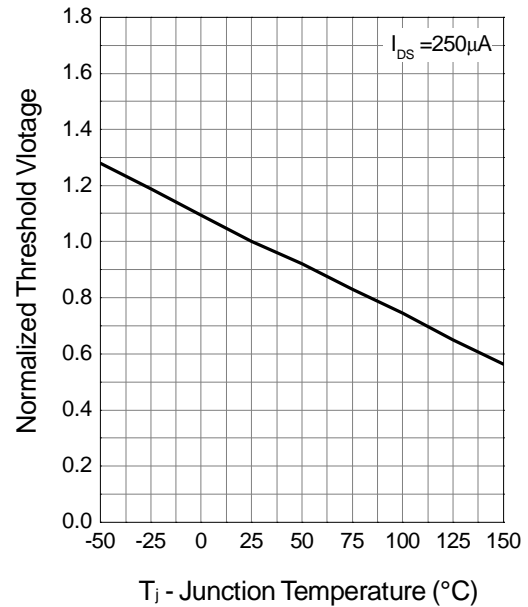

Typical Characteristics (Cont.)

Drain-Source On Resistance

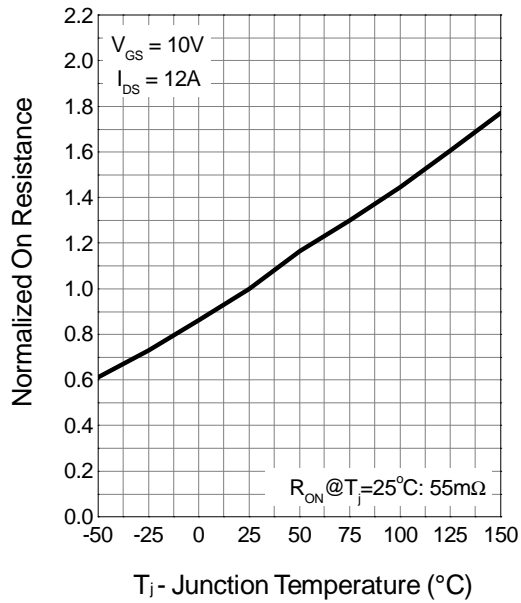

Source-Drain Diode Forward

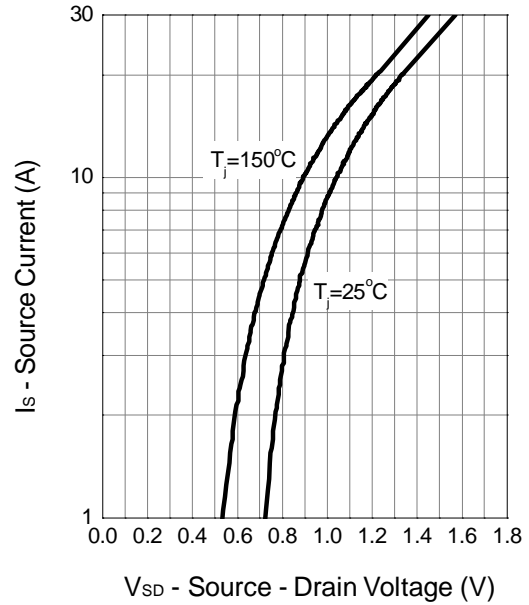

Capacitance

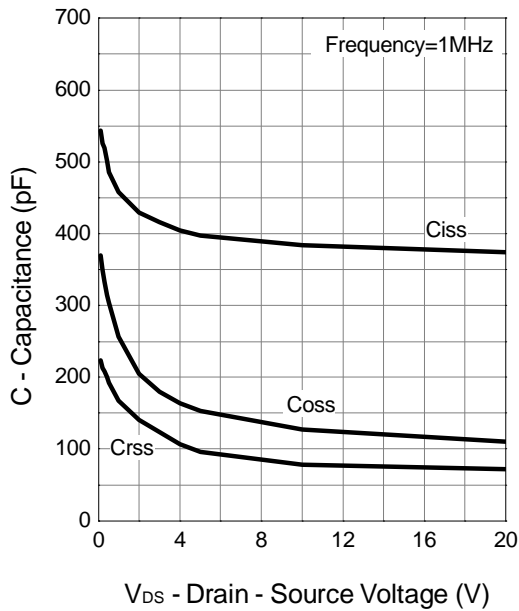

Gate Charge

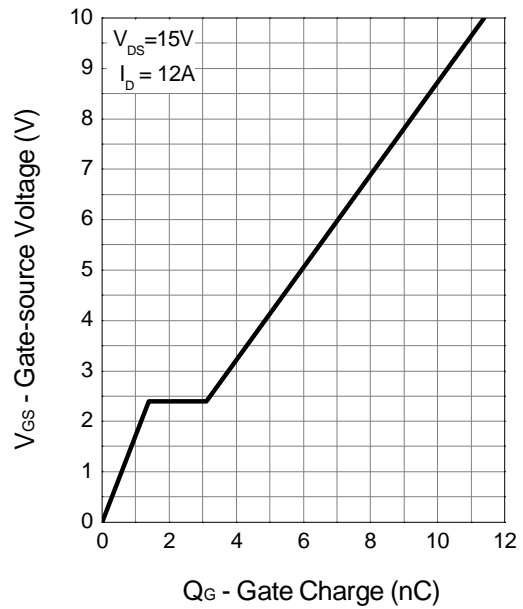

Package Information

TO-252 (Reference JEDEC Registration TO-252)

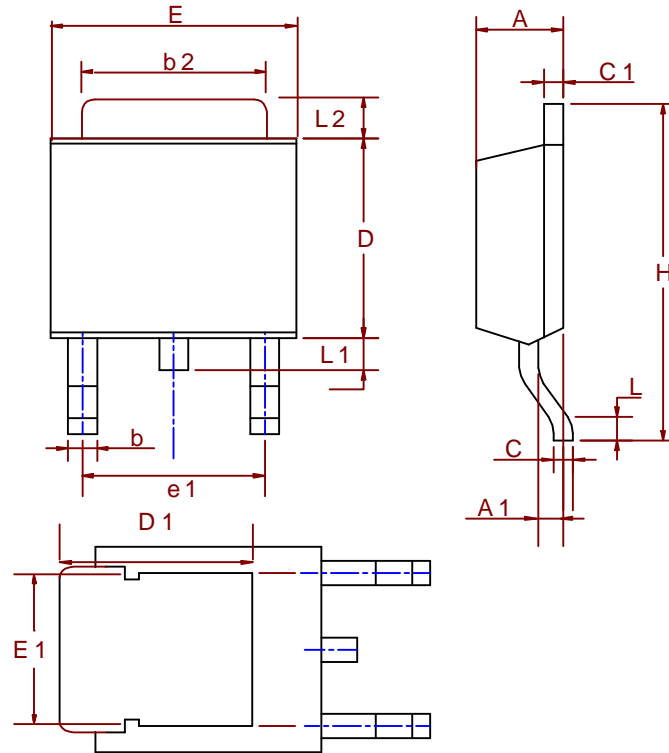

Dim	Millimeters		Inches	
	Min.	Max.	Min.	Max.
A	2.18	2.39	0.086	0.094
A1	0.89	1.27	0.035	0.050
b	0.508	0.89	0.020	0.035
b2	5.207	5.461	0.205	0.215
C	0.46	0.58	0.018	0.023
C1	0.46	0.58	0.018	0.023
D	5.334	6.22	0.210	0.245
D1	5.2 REF		0.205 REF	
E	6.35	6.73	0.250	0.265
E1	5.3 REF		0.209 REF	
e1	3.96	5.18	0.156	0.204
H	9.398	10.41	0.370	0.410
L	0.51		0.020	
L1	0.64	1.02	0.025	0.040
L2	0.89	2.032	0.035	0.080

Physical Specifications

Terminal Material	Solder-Plated Copper (Solder Material : 90/10 or 63/37 SnPb), 100%Sn
Lead Solderability	Meets EIA Specification RSI86-91, ANSI/J-STD-002 Category 3.

Reflow Condition (IR/Convection or VPR Reflow)

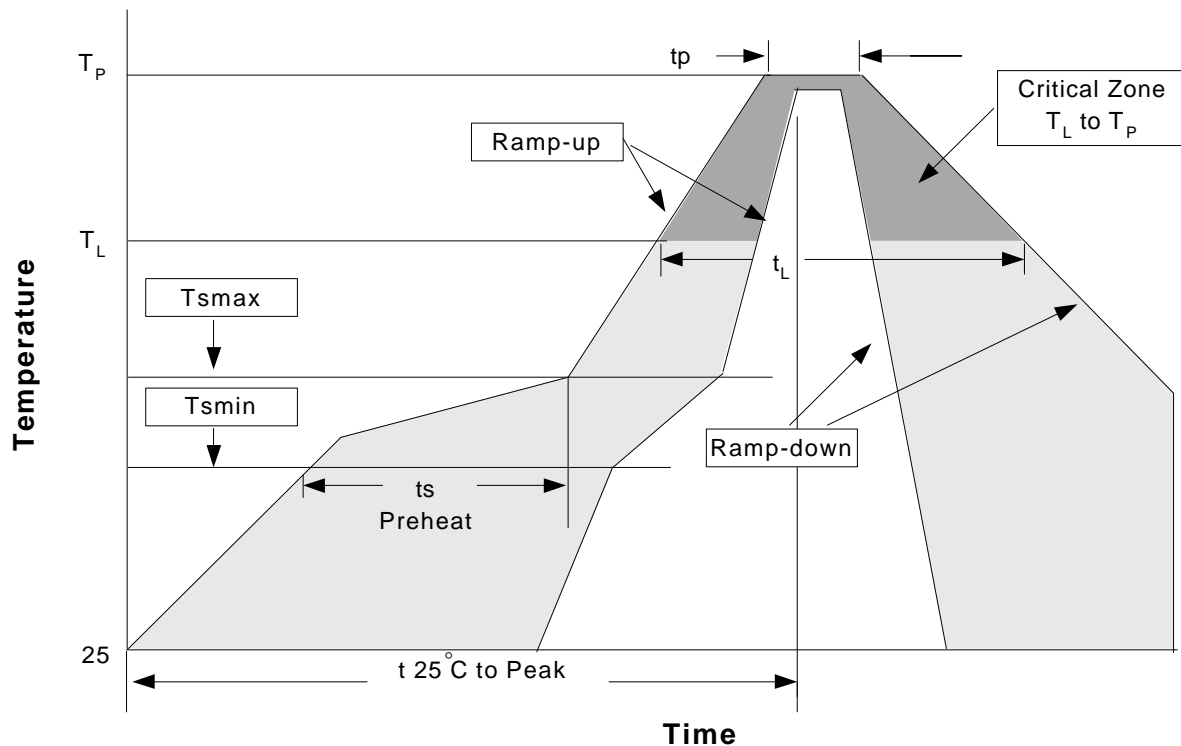

Classification Reflow Profiles

Profile Feature	Sn-Pb Eutectic Assembly	Pb-Free Assembly
Average ramp-up rate (T_L to T_P)	3°C/second max.	3°C/second max.
Preheat <ul style="list-style-type: none"> - Temperature Min (T_{smin}) - Temperature Max (T_{smax}) - Time (min to max) (t_s) 	100°C 150°C 60-120 seconds	150°C 200°C 60-180 seconds
Time maintained above: <ul style="list-style-type: none"> - Temperature (T_L) - Time (t_L) 	183°C 60-150 seconds	217°C 60-150 seconds
Peak/Classification Temperature (T_p)	See table 1	See table 2
Time within 5°C of actual Peak Temperature (t_p)	10-30 seconds	20-40 seconds
Ramp-down Rate	6°C/second max.	6°C/second max.
Time 25°C to Peak Temperature	6 minutes max.	8 minutes max.

Notes: All temperatures refer to topside of the package .Measured on the body surface.

Classification Reflow Profiles(Cont.)

Table 1. SnPb Eutectic Process – Package Peak Reflow Temperatures

Package Thickness	Volume mm ³ <350	Volume mm ³ ≥350
<2.5 mm	240 +0/-5°C	225 +0/-5°C
≥2.5 mm	225 +0/-5°C	225 +0/-5°C

Table 2. Pb-free Process – Package Classification Reflow Temperatures

Package Thickness	Volume mm ³ <350	Volume mm ³ 350-2000	Volume mm ³ >2000
<1.6 mm	260 +0°C*	260 +0°C*	260 +0°C*
1.6 mm – 2.5 mm	260 +0°C*	250 +0°C*	245 +0°C*
≥2.5 mm	250 +0°C*	245 +0°C*	245 +0°C*

*Tolerance: The device manufacturer/supplier **shall** assure process compatibility up to and including the stated classification temperature (this means Peak reflow temperature +0°C. For example 260°C+0°C) at the rated MSL level.

Reliability Test Program

Test item	Method	Description
SOLDERABILITY	MIL-STD-883D-2003	245°C, 5 SEC
HOLT	MIL-STD 883D-1005.7	1000 Hrs Bias @ 125°C
PCT	JESD-22-B, A102	168 Hrs, 100% RH, 121°C
TST	MIL-STD 883D-1011.9	-65°C ~ 150°C, 200 Cycles

Carrier Tape & Reel Dimensions

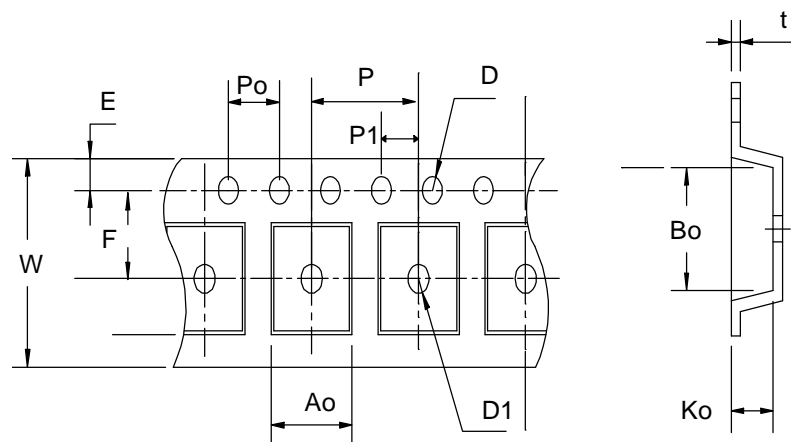

Carrier Tape & Reel Dimensions (Cont.)

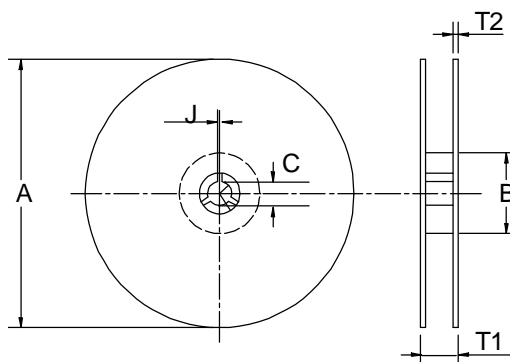

Application	A	B	C	J	T1	T2	W	P	E
TO-252	330 ±3	100 ±2	13 ±0.5	2 ±0.5	16.4 +0.3 -0.2	2.5 ±0.5	16+ 0.3 -0.1	8 ±0.1	1.75 ±0.1
	F	D	D1	Po	P1	Ao	Bo	Ko	t
	7.5 ±0.1	1.5 +0.1	1.5 ±0.25	4.0 ±0.1	2.0 ±0.1	6.8 ±0.1	10.4 ±0.1	2.5 ±0.1	0.3 ±0.05

(mm)

Cover Tape Dimensions

Application	Carrier Width	Cover Tape Width	Devices Per Reel
TO-252	16	13.3	2500

Customer Service

Anpec Electronics Corp.

Head Office :

No.6, Dusing 1st Road, SBIP,

Hsin-Chu, Taiwan, R.O.C.

Tel : 886-3-5642000

Fax : 886-3-5642050

Taipei Branch :

7F, No. 137, Lane 235, Pac Chiao Rd.,

Hsin Tien City, Taipei Hsien, Taiwan, R. O. C.

Tel : 886-2-89191368

Fax : 886-2-89191369