

勝特力材料 886-3-5753170
 勝特力电子(上海) 86-21-54151736
 勝特力电子(深圳) 86-755-83298787
[Http://www.100y.com.tw](http://www.100y.com.tw)

Bulletin PD-20059 rev. C 05/01

International IR Rectifier

30EPH03

Ultrafast Rectifier

Features

- Ultrafast Recovery Time
- Low Forward Voltage Drop
- Low Leakage Current
- 175°C Operating Junction Temperature

$$t_{rr} = 55ns$$

$$I_{F(AV)} = 30Amp$$

$$V_R = 300V$$

Description/ Applications

International Rectifier's 300V series are the state of the art Ultrafast recovery rectifiers designed with optimized performance of forward voltage drop and Ultrafast recovery time.

The planar structure and the platinum doped life time control guarantee the best overall performance, ruggedness and reliability characteristics.

These devices are intended for use in the output rectification stage of SMPS, UPS, DC-DC converters as well as freewheeling diodes in low voltage inverters and chopper motor drives.

Their extremely optimized stored charge and low recovery current minimize the switching losses and reduce over dissipation in the switching element and snubbers.

Absolute Maximum Ratings

Parameters		Max	Units
V_{RRM}	Repetitive Peak Reverse Voltage	300	V
$I_{F(AV)}$	Average Rectified Forward Current @ $T_c = 143^\circ C$	30	A
I_{FSM}	Non Repetitive Peak Surge Current @ $T_j = 25^\circ C$	300	
T_j, T_{STG}	Operating Junction and Storage Temperatures	- 65 to 175	$^\circ C$

Case Styles

30EPH03



TO247

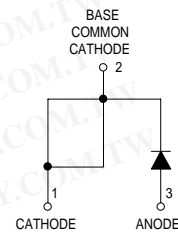

勝特力材料 886-3-5753170
 胜特力电子(上海) 86-21-54151736
 胜特力电子(深圳) 86-755-83298787
 Http://www.100y.com.tw

30EPH03

Bulletin PD-20059 rev. C 05/01

International
IR Rectifier

Electrical Characteristics @ T_J = 25°C (unless otherwise specified)

Parameters	Min	Typ	Max	Units	Test Conditions
V _{BR} , V _r Breakdown Voltage, Blocking Voltage	300	-	-	V	I _R = 100μA
V _F Forward Voltage	-	1.08	1.25	V	I _F = 30A, T _J = 25°C
	-	0.9	1.00	V	I _F = 30A, T _J = 125°C
I _R Reverse Leakage Current	-	0.05	60	μA	V _R = V _R Rated
	-	280	600	μA	T _J = 125°C, V _R = V _R Rated
C _T Junction Capacitance	-	90	-	pF	V _R = 300V
L _S Series Inductance	-	3.5	-	nH	Measured lead to lead 5mm from package body

Dynamic Recovery Characteristics @ T_J = 25°C (unless otherwise specified)

Parameters	Min	Typ	Max	Units	Test Conditions
t _{rr} Reverse Recovery Time	-	-	55	ns	I _F = 1.0A, di _F /dt = 50A/μs, V _R = 30V
	-	38	-		T _J = 25°C
	-	52	-		T _J = 125°C
I _{RRM} Peak Recovery Current	-	2.8	-	A	T _J = 25°C
	-	7.3	-		T _J = 125°C
Q _{rr} Reverse Recovery Charge	-	53	-	nC	T _J = 25°C
	-	190	-		T _J = 125°C

Thermal - Mechanical Characteristics

Parameters	Min	Typ	Max	Units
T _J Max. Junction Temperature Range	- 65	-	175	°C
T _{Stg} Max. Storage Temperature Range	- 65	-	175	
R _{thJC} Thermal Resistance, Junction to Case		0.5	0.9	°C/W
R _{thJA} ^① Thermal Resistance, Junction to Ambient		-	40	
R _{thCS} ^② Thermal Resistance, Case to Heatsink		0.4	-	
Wt Weight	-	6.0	-	g
	-	0.22	-	(oz)
Mounting Torque	6.0	-	12	Kg-cm
	5.0	-	10	lbf.in

① Typical Socket Mount

② Mounting Surface, Flat, Smooth and Greased

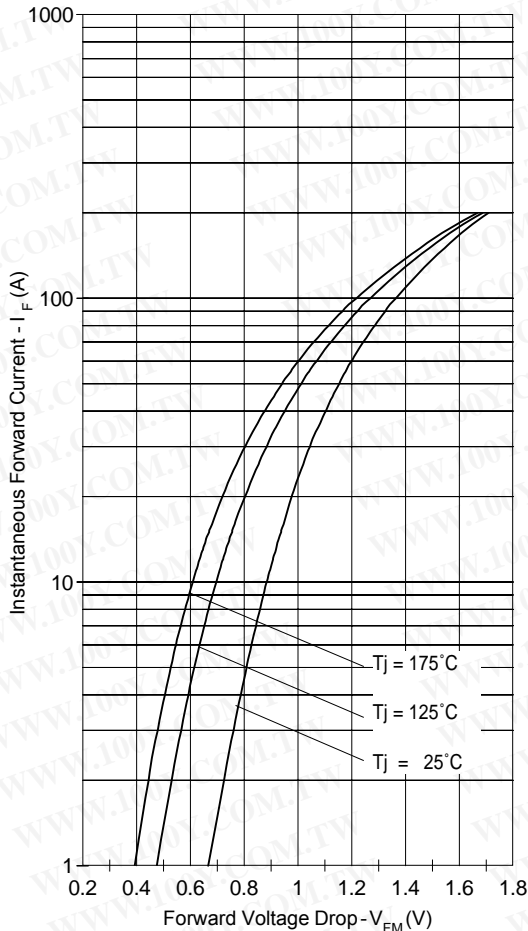

Fig. 1 - Typical Forward Voltage Drop Characteristics

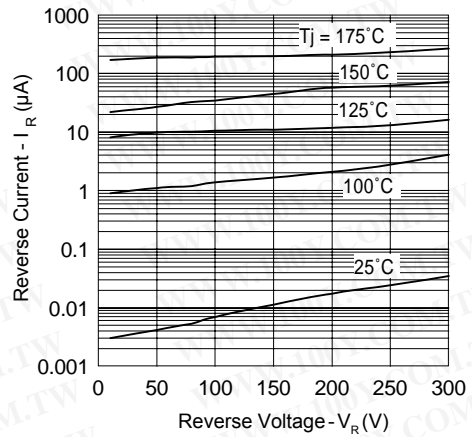

Fig. 2 - Typical Values Of Reverse Current Vs. Reverse Voltage

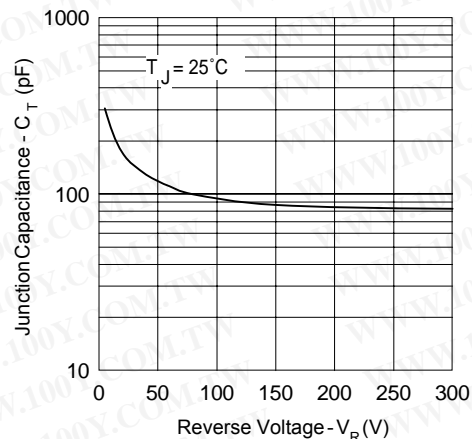

Fig. 3 - Typical Junction Capacitance Vs. Reverse Voltage

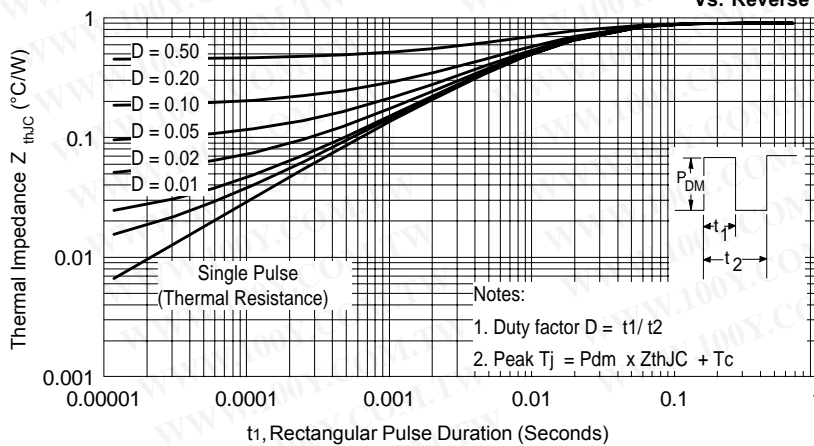

Fig. 4 - Max. Thermal Impedance Z_{thJC} Characteristics

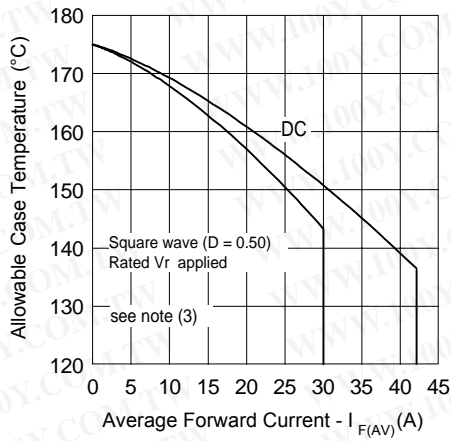

Fig. 5 - Max. Allowable Case Temperature Vs. Average Forward Current

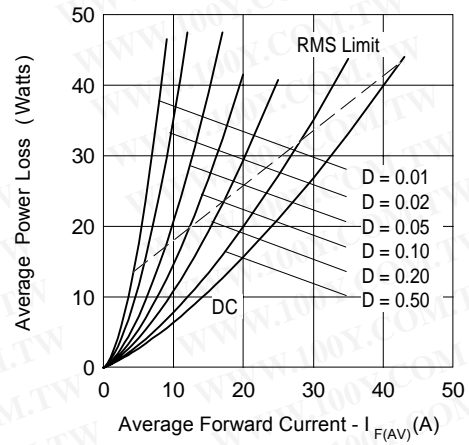

Fig. 6 - Forward Power Loss Characteristics

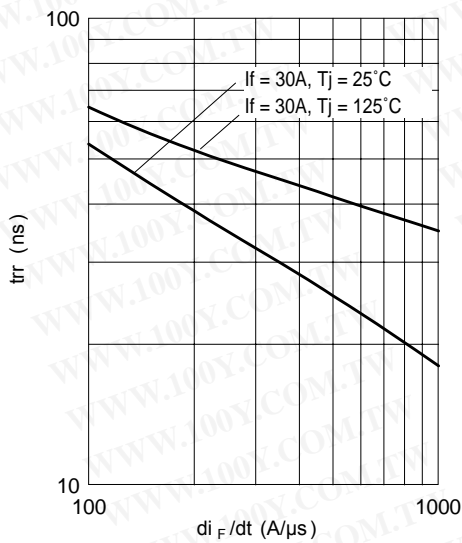

Fig. 7 - Typical Reverse Recovery vs. di_F/dt

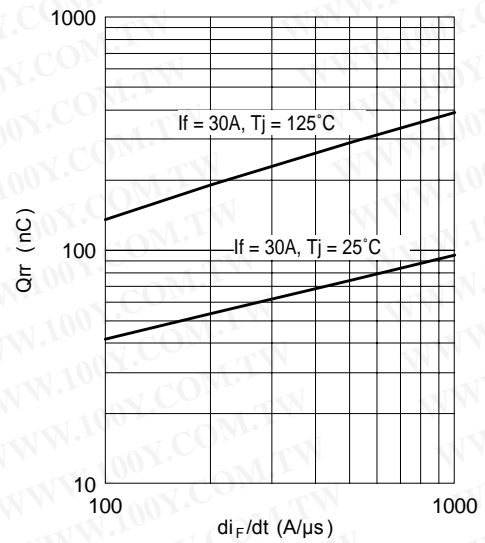

Fig. 8 - Typical Stored Charge vs. di_F/dt

(3) Formula used: $T_C = T_J - (P_d + P_{d_{REV}}) \times R_{thJC}$;
 $P_d = \text{Forward Power Loss} = I_{F(AV)} \times V_{FM} @ (I_{F(AV)}/D)$ (see Fig. 6);
 $P_{d_{REV}} = \text{Inverse Power Loss} = V_{R1} \times I_R (1-D)$; $I_R @ V_{R1} = \text{rated } V_R$

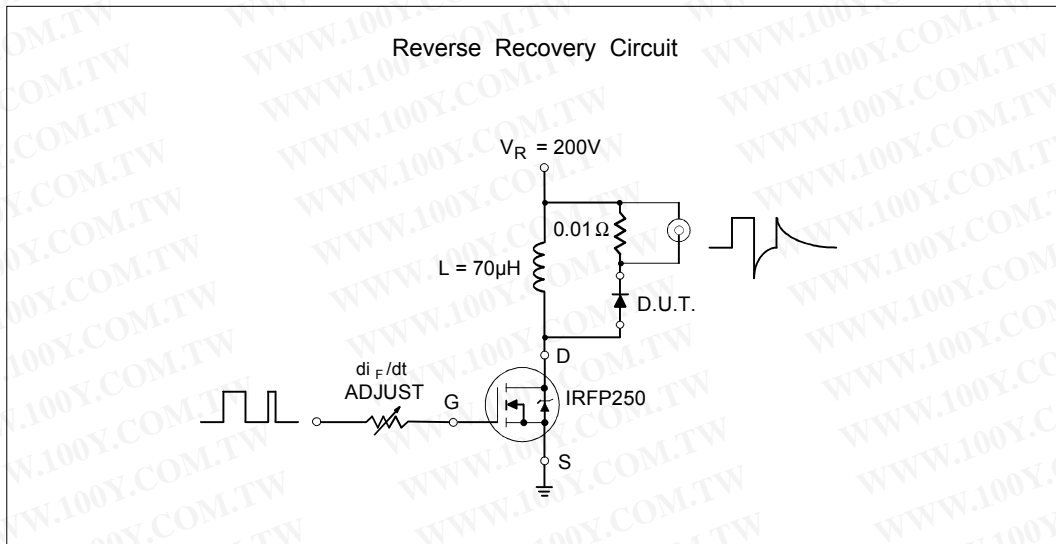

Fig. 9 - Reverse Recovery Parameter Test Circuit

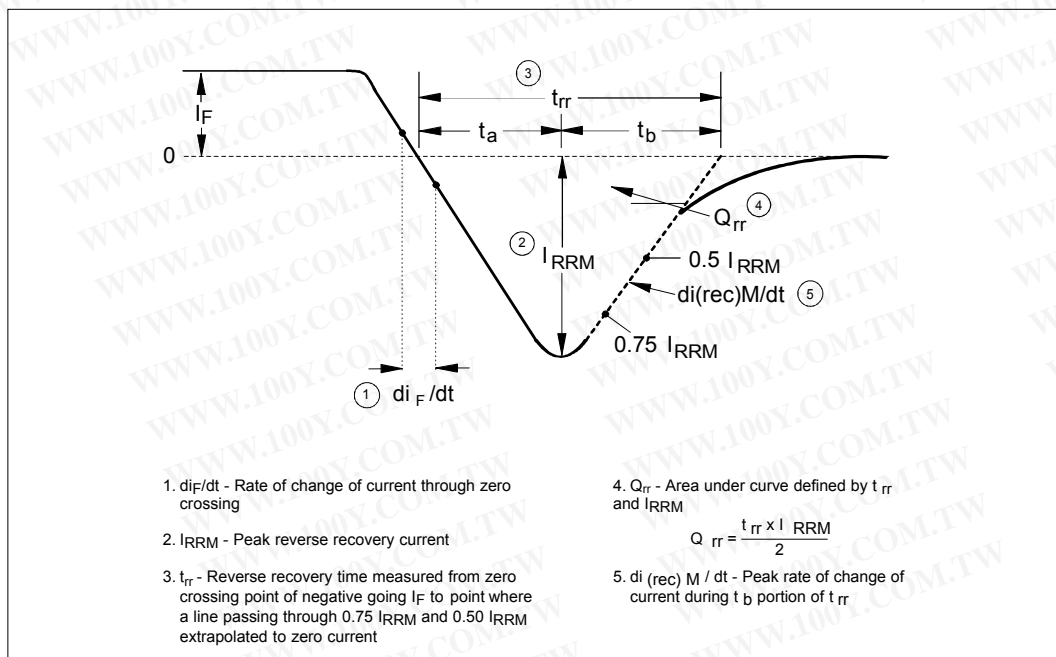

Fig. 10 - Reverse Recovery Waveform and Definitions

勝特力材料 886-3-5753170
 勝特力电子(上海) 86-21-54151736
 勝特力电子(深圳) 86-755-83298787
 Http://www.100y.com.tw

30EPH03

Bulletin PD-20059 rev. C 05/01

International
IR Rectifier

Outline Table

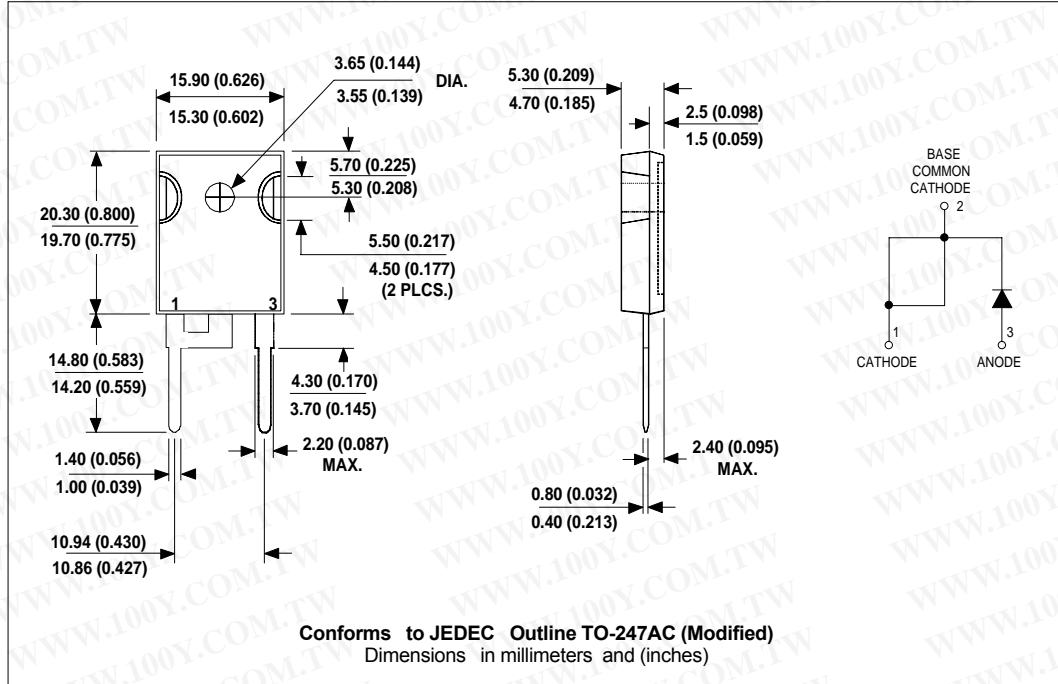

Marking Information

