



**24mm Metal Shaft Rotary Potentiometer**  
**24mm 金屬軸旋轉電位器**

勝特力材料 886-3-5753170  
 勝特力电子(上海) 86-21-34970699  
 勝特力电子(深圳) 86-755-83298787  
[Http://www.100y.com.tw](http://www.100y.com.tw)

**R-24N1**



**Part Number**

**R-24N1 - B 50K, L - 20 KC**

Taper      Resistance Value      Shaft Type  
 線性      阻值      軸型  
 Shaft Length  
 軸長

**Dimensions 規格尺寸**

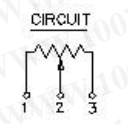
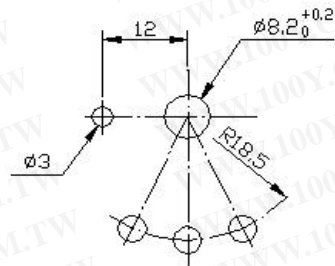
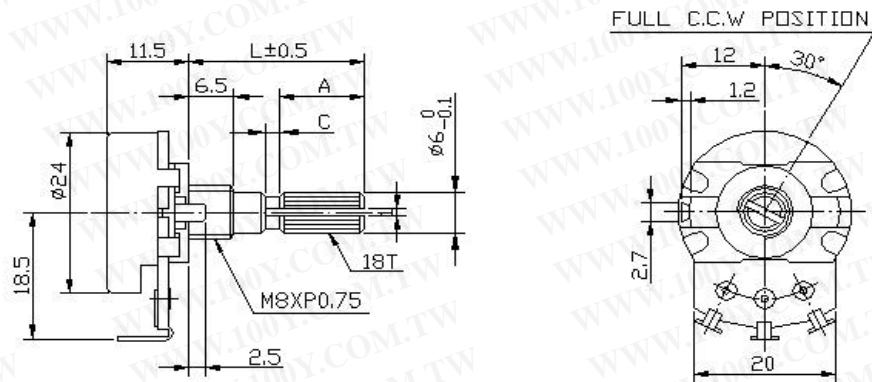

**Shaft Type 軸型**

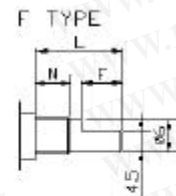
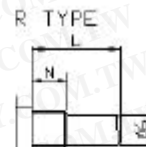
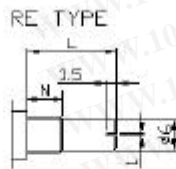
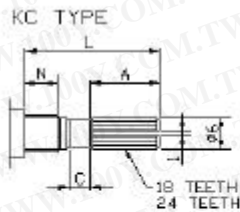

Ni6.5m/m

SHAFT-TYPE	L	10	15	20	25	30	35	40
KC	A	2.2	6	10	12	12	12	12
	C	0.5	1	2	2	4	4	4
F	F	2.5	7	12	12	12	12	12
R,RE	L	10	15	20	25	30	35	40



**24mm Metal Shaft Rotary Potentiometer**  
**24mm 金屬軸旋轉電位器**

**Electrical Characteristics 電氣特性**

All Resistance 總阻值	1K ~ 1M				
All Resistance Tolerance 總阻值誤差	± 20% (more than 1M ± 30%)				
Resistance Taper 線性	A. B. C. D. W. Taper				
Resistance Taper Characteristics 阻值變化特性範圍	A50%	B50%	C50%	D50%	W50%
	15-25%	40-60%	75-85%	2-15%	45-55%
Rated Power 定格電力	B Taper: AC500V0.5W; Other Taper: AC250V0.25 W				
Residual Resistance 殘留阻值	R <sup>3</sup> 250K 0.1%				
	250K > R > 10K	10	Max.		
	10K <sup>3</sup> R	10	Max.		
Noise 雜音	47 mV max.				
Insulation Resistance 絕緣阻抗	More than 100M at DC 500V				
Withstand Voltage 耐電壓	1 minute at AC 250V				
Rotational Life 旋轉壽命	15,000 Cycles.				

勝特力材料 886-3-5753170  
 勝特力电子(上海) 86-21-34970699  
 勝特力电子(深圳) 86-755-83298787  
[Http://www.100y.com.tw](http://www.100y.com.tw)

**Mechanical Characteristics 機械特性**

Total Rotational Angle 全迴轉角度	300° ± 10°
Stopper Strength 全迴轉止強度	5 kgf.cm max./ 3 sec .
Rotational Torque 旋轉扭力	30 ~ 200gf.cm max.
Push-Pull Strength 壓入拉起強度	10 kgf.cm max./3 sec.
Solder Heat 焊錫耐熱性	300 ,3s (Only For Hand-Soldering)
Remark 備註	Shaft: Cast Iron , Aluminum Zinc , Plastic Bushing Material: cast iron