

RC

●Features

1. Improved pulse endurance characteristics compared to carbon-film devices.
2. Wide resistance range is available, 1 ohm ~ 22M ohm.
3. Stability Class : 10%

勝特力材料 886-3-5753170
 勝特力电子(上海) 86-21-34970699
 勝特力电子(深圳) 86-755-83298787
[Http://www.100y.com.tw](http://www.100y.com.tw)

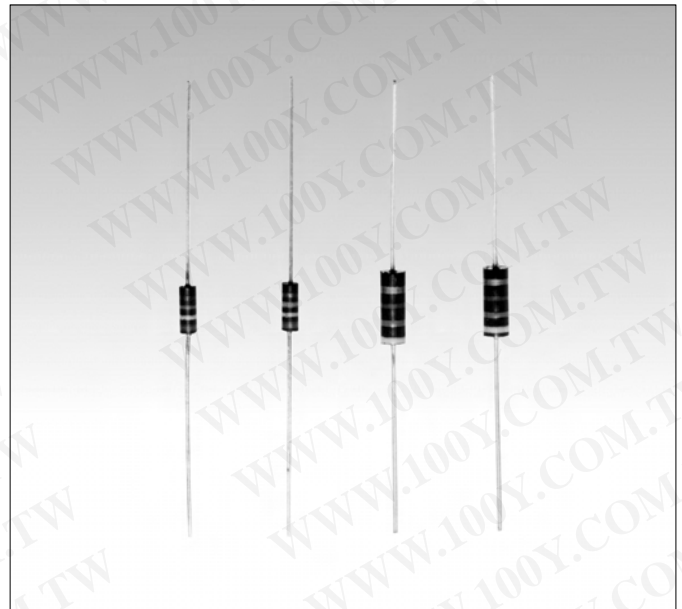

●Dimensions

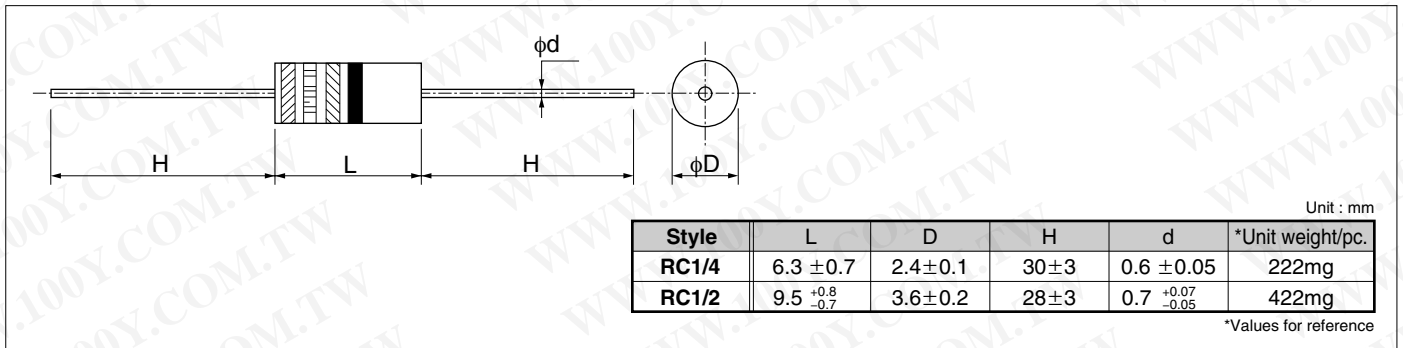

●Part Number Description

Example

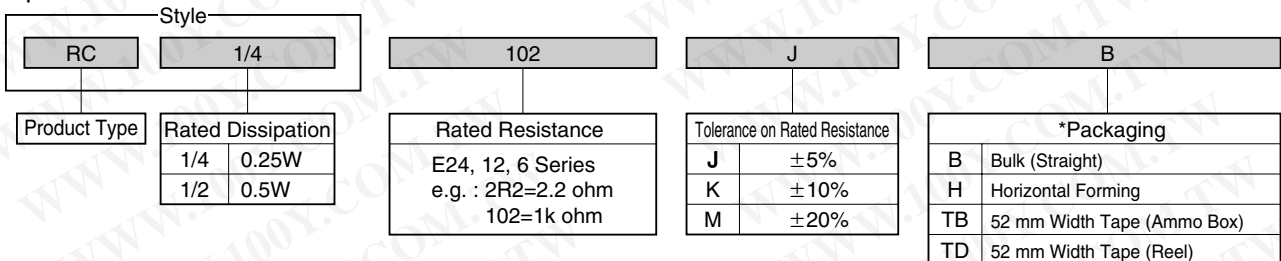

*Refer to Tape and Packaging information on pages 64.

FIXED CARBON COMPOSITION RESISTORS

RC

●Ratings

Style	Rated Dissipation at 70°C W	Limiting Element Voltage V	Rated Resistance Range	Combination of Rated Resistance Range and Temperature Coefficient of Resistance			Tolerance on Rated Resistance and Preferred Number Series for Resistors	Isolation Voltage V	Category Temperature Range °C
				Temperature Coefficient of Resistance %		Rated Resistance Range			
				at -55 °C	at +125 °C				
RC1/4	0.25	250	1 ohm~5.6M ohm	+6.5 ~0 +10 ~0	+1~-5 0~-6	1 ohm ~ 1k ohm 1.1k ohm ~ 10k ohm	100	-55~+125	
RC1/2	0.5	350	1 ohm~22M ohm	+13 ~0 +15 ~0 +20 ~0	0~-7.5 0~-10 0~-15	11k ohm ~100k ohm 110k ohm ~ 1M ohm 1.1M ohm ~ 22M ohm			500

Note1. Rated Voltage = $\sqrt{(\text{Rated Dissipation}) \times (\text{Rated Resistance})}$. (d.c. or a.c. r.m.s. Voltage)

Note2. Limiting Element Voltage can only be applied to resistors when the resistance value is equal to or higher than the critical resistance value.

Note3. Critical Resistance Value is the resistance value at which the rated voltage is equal to the limiting element voltage.

●Storage

Temperature 20±15°C, Humidity 60%R.H. Max, Recommendation Storing Term 6 months after shipped from factory.

●Derating Curve

The derated values of dissipation for temperatures in excess of 70°C shall be indicated by the following Curve.

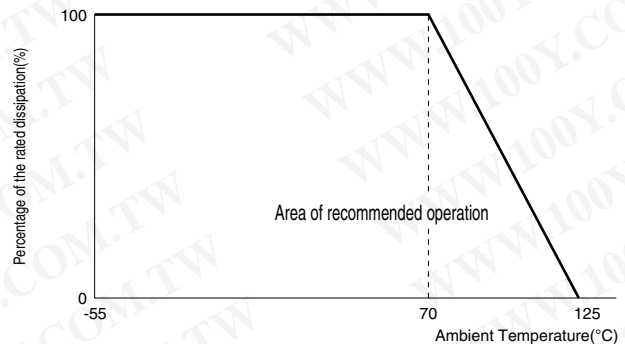

●Climatic Category

55/125/56

Lower Category Temperature	-55°C
Upper Category Temperature	+125°C
Duration of the Damp heat, Steady-State Test	56 days

●Performance Characteristics JIS C 5201-1 : 1998

Description	Requirements	Test Methods
Voltage proof	No breakdown or flashover	Clause 4.7 V-block method RC1/4 100Va.c.,60s RC1/2 500Va.c.,60s
Variation of resistance with temperature	See Ratings Table	Clause 4.8 Measuring temperature : +20°C/-55°C/ +20°C/+125°C/+20°C
Overload	$\Delta R_{\leq \pm}(2\%+0.1 \text{ ohm})$ No visible damage, legible marking	Clause 4.13 The applied voltage shall be 2.5 times of the rated voltage or twice of the limiting element voltage, whichever is the less Severe, 5s.
Robustness of terminations	Tensile $\Delta R_{\leq \pm}(2\%+0.1 \text{ ohm})$ No visible damage	Clause 4.16.2 10N for 5~10s
	Bending $\Delta R_{\leq \pm}(2\%+0.1 \text{ ohm})$ No visible damage	Clause 4.16.3 5N twice
	Torsion $\Delta R_{\leq \pm}(2\%+0.1 \text{ ohm})$ No visible damage	Clause 4.16.4 180°C, 2 rotation
Solderability	In accordance with Clause 4.17.4.5	Clause 4.17 235°C, 5s
Resistance to soldering heat	$\Delta R_{\leq \pm}(3\%+0.1 \text{ ohm})$ No visible damage, legible marking	Clause 4.18 After immersion into the flux, the immersion into solder shall be carried out 4mm from the body at 350°C for 3.5s.
Rapid change of temperature	$\Delta R_{\leq \pm}(2\%+0.1 \text{ ohm})$ No visible damage	Clause 4.19 5 cycles between -55°C and +125°C.
Climatic sequence	$\Delta R_{\leq \pm}(10\%+0.5 \text{ ohm})$ Insulation resistance : $R_{\geq 100M \text{ ohm}}$ No visible damage	Clause 4.23 Dry/Damp heat(12+12h cycle), first cycle./ Cold/Damp heat(12+12h cycle), remaining cycle./ D.C.Load.
Damp test, steady state	$\Delta R_{\leq \pm}(10\%+0.5 \text{ ohm})$ Insulation resistance : $R_{\geq 100M \text{ ohm}}$ No visible damage, legible marking	Clause 4.24 40°C, 95%R.H., 56 days, test a), b) and c) of Clause 4.24.2.1
Endurance at 70°C	$\Delta R_{\leq \pm}(10\%+0.5 \text{ ohm})$ No visible damage Insulation resistance : $R_{\geq 1G \text{ ohm}}$	Clause 4.25.1 Rated voltage, 1.5h "ON", 0.5h "OFF", 70°C, 1,000h.
Endurance at the upper category temperature	$\Delta R_{\leq \pm}(10\%+0.5 \text{ ohm})$ No visible damage Insulation resistance : $R_{\geq 1G \text{ ohm}}$	Clause 4.25.3 125°C, no-load, 1,000h.

FIXED CARBON COMPOSITION RESISTORS

RC

●Typical Characteristics

●Surge Resistance Characteristics

Charging and discharging a 2,000 pF capacitor for 100 cycles.

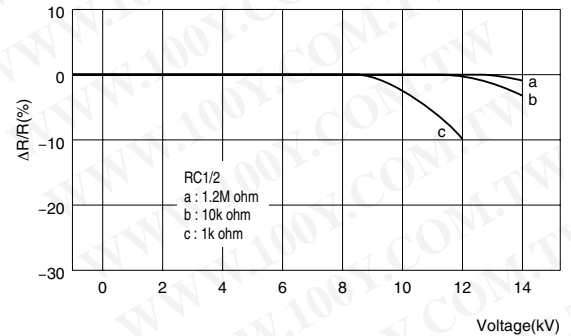
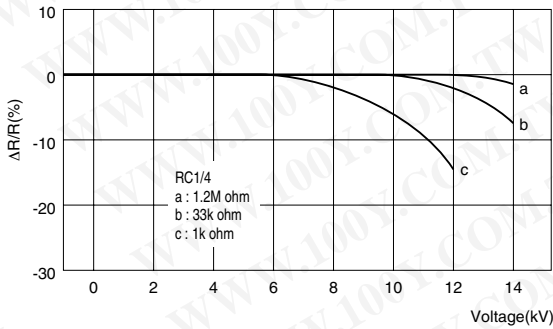

●Relationship between Load Ratio and Category Temperature

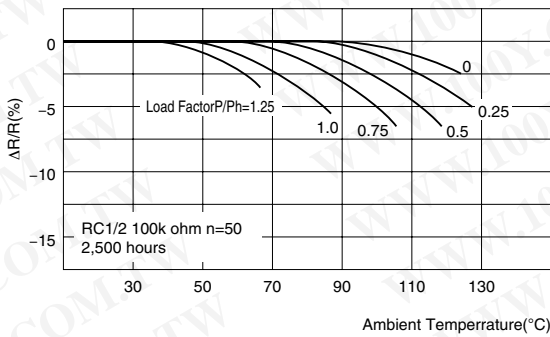

●Endurance at 70°C

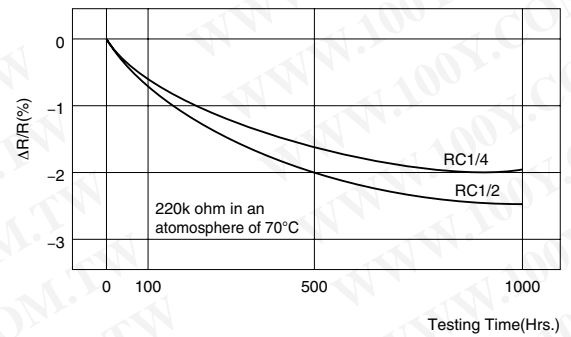

●Variation with Time

Condition : 5~35°C , 45~85% R.H.

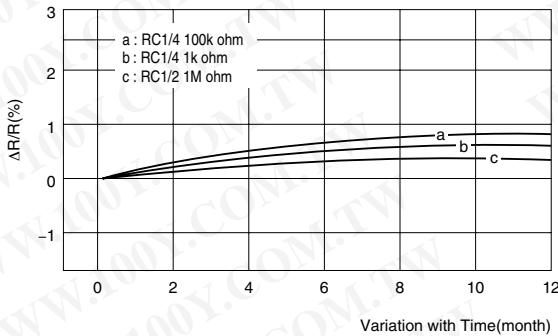

●Frequency Characteristics

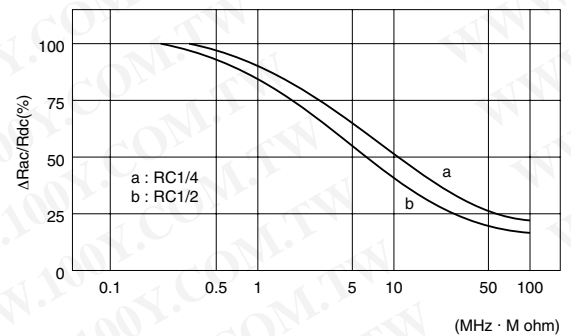

●Reliability Test

Endurance in humidity

Samples : RC1/4J,100 ohm,1k ohm,10k ohm,100k ohm×150 each. Total 2,400.

Conditions : Direct current voltage equivalent to the following load ratings in cycles on "ON" for 1.5h and "OFF" for 0.5h for a total of 5,000h in an atmosphere of 40°C, 90 to 95%R.H.

"Typical characteristics indicate the mean values of ΔR/R etc."

Criterion (%)	Load Ratio P/Pn (%)	Total Testing Time T(Hrs.)	Number of Failures r(pcs.)	Failure Ratio		Average Lifetime (60% reliability level) (Hrs.)	
				$\hat{\lambda}$	$\lambda_{CL}(60\%)$		
ΔR/R	±5	0	2.984X10 ⁶	6	0.201	0.244	4.098×10 ⁵
		20	2.990X10 ⁶	4	0.134	0.176	5.682×10 ⁵
		60	2.997X10 ⁶	2	0.067	0.104	9.615×10 ⁵
		100	2.992X10 ⁶	3	0.100	0.139	7.194×10 ⁵
		Total	1.196X10 ⁷	15	0.125	0.138	7.209×10 ⁵
±10	Total	1.20X10 ⁷	0	0.0055	0.007	1.299×10 ⁷	