

# 2SC4466

勝特力材料 886-3-5753170  
 勝特力电子(上海) 86-21-54151736  
 勝特力电子(深圳) 86-755-83298787  
 Http://www.100y.com.tw

Silicon NPN Triple Diffused Planar Transistor (Complement to type 2SA1693)

Application : Audio and General Purpose

**Absolute maximum ratings** (Ta=25°C)

| Symbol           | 2SC4466     | Unit |
|------------------|-------------|------|
| V <sub>CB0</sub> | 120         | V    |
| V <sub>CEO</sub> | 80          | V    |
| V <sub>EBO</sub> | 6           | V    |
| I <sub>C</sub>   | 6           | A    |
| I <sub>B</sub>   | 3           | A    |
| P <sub>C</sub>   | 60(Tc=25°C) | W    |
| T <sub>ij</sub>  | 150         | °C   |
| T <sub>stg</sub> | -55 to +150 | °C   |

**Electrical Characteristics** (Ta=25°C)

| Symbol               | Conditions                                  | 2SC4466 | Unit |
|----------------------|---|---------|------|
| I <sub>CB0</sub>     | V <sub>CB</sub> =120V                       | 10max   | μA   |
| I <sub>EBO</sub>     | V <sub>EB</sub> =6V                         | 10max   | μA   |
| V <sub>(BR)CEO</sub> | I <sub>C</sub> =50mA                        | 80min   | V    |
| h <sub>FE</sub>      | V <sub>CE</sub> =4V, I <sub>C</sub> =2A     | 50min*  |      |
| V <sub>CE(sat)</sub> | I <sub>C</sub> =2A, I <sub>B</sub> =0.2A    | 1.5max  | V    |
| f <sub>T</sub>       | V <sub>CE</sub> =12V, I <sub>E</sub> =-0.5A | 20typ   | MHz  |
| COB                  | V <sub>CB</sub> =10V, f=1MHz                | 110typ  | pF   |

\*h<sub>FE</sub> Rank O(50to100), P(70to140), Y(90to180)

**Typical Switching Characteristics (Common Emitter)**

| V <sub>CC</sub> (V) | R <sub>L</sub> (Ω) | I <sub>C</sub> (A) | V <sub>BB1</sub> (V) | V <sub>BB2</sub> (V) | I <sub>B1</sub> (A) | I <sub>B2</sub> (A) | t <sub>on</sub> (μs) | t <sub>stg</sub> (μs) | t <sub>f</sub> (μs) |
|---------------------|--------------------|--------------------|----------------------|----------------------|---------------------|---------------------|----------------------|-----------------------|---------------------|
| 30                  | 10                 | 3                  | 10                   | -5                   | 0.3                 | -0.3                | 0.16typ              | 2.60typ               | 0.34typ             |

**External Dimensions MT-100(TO3P)**

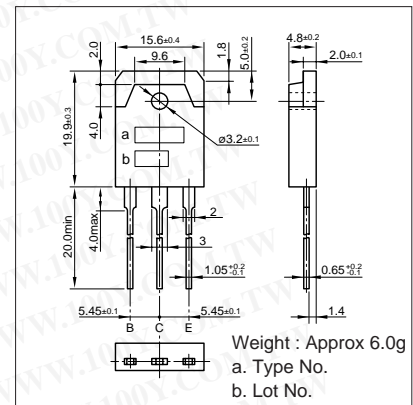

**I<sub>C</sub>-V<sub>CE</sub> Characteristics (Typical)**

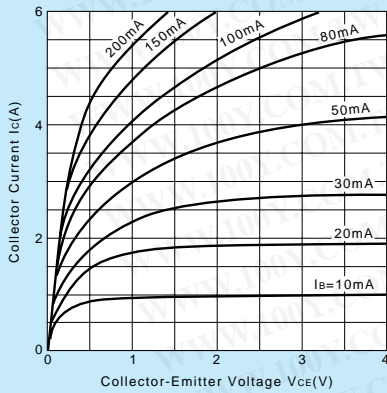

**V<sub>CE(sat)</sub>-I<sub>B</sub> Characteristics (Typical)**

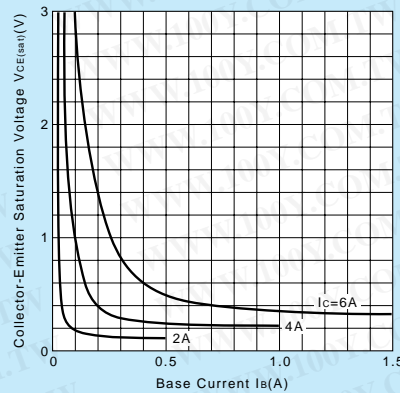

**I<sub>C</sub>-V<sub>BE</sub> Temperature Characteristics (Typical)**

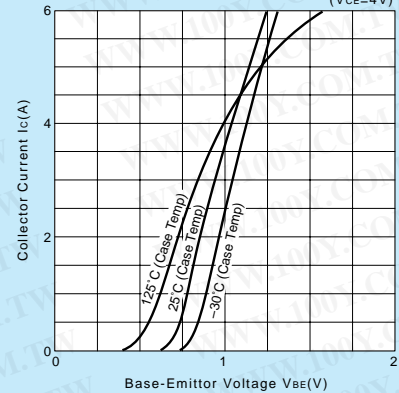

**h<sub>FE</sub>-I<sub>C</sub> Characteristics (Typical)**

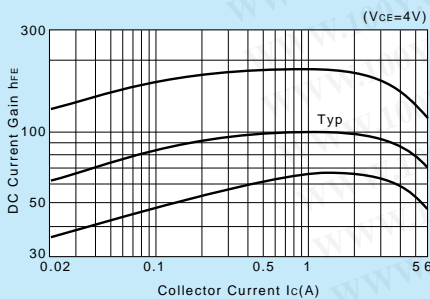

**h<sub>FE</sub>-I<sub>C</sub> Temperature Characteristics (Typical)**

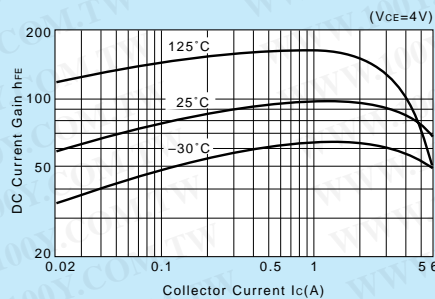

**θ<sub>j-a</sub>-t Characteristics**

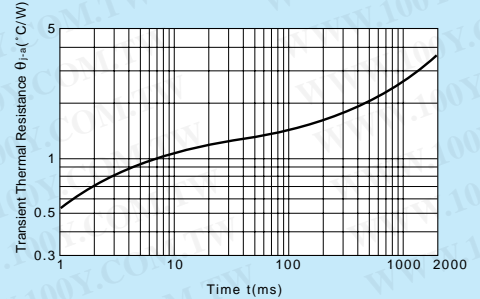

**f<sub>T</sub>-I<sub>E</sub> Characteristics (Typical)**

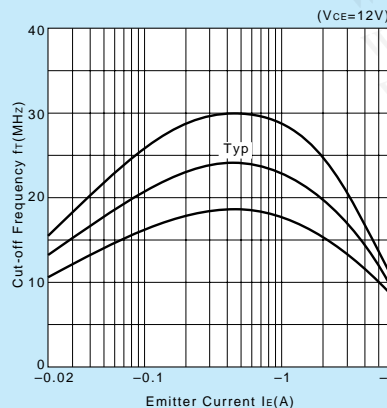

**Safe Operating Area (Single Pulse)**

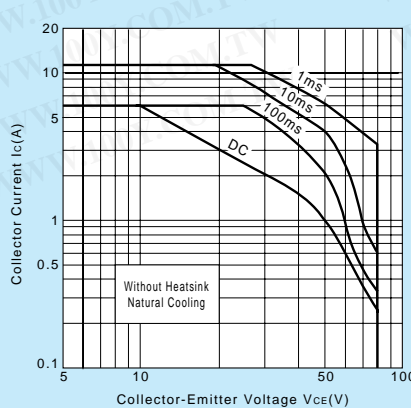

**P<sub>C</sub>-T<sub>a</sub> Derating**

