

# APPLICATION DATA

## HOW REED RELAYS WORK

The term reed relay covers dry reed relays and mercury-wetted contact relays, all of which use hermetically sealed reed switches. In both types, the reeds (thin, flat blades) serve multiple functions - as conductor, contacts, springs, and magnetic armatures.

## DRY REED RELAYS

Dry reed relays have become an important factor in the relay field. They have the advantage of being hermetically sealed and resistant to atmospheric contamination. They have fast operate and release times and when operated within their rated contact loads, have very long life. A typical dry reed switch capsule is shown in Figure 1.

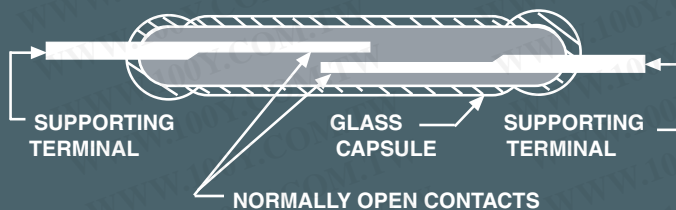

Figure 1. Construction of Switch Capsule of Typical Dry Reed switch (SPST-NO)

In the basic SPST-NO design, two opposing blades are sealed into a narrow glass capsule and overlapped at their free ends. The contact area is plated typically with rhodium to produce a low contact resistance when contacts are drawn together. The capsule is made of glass and filled with a dry inert gas and then sealed. The capsule is surrounded by an electromagnetic coil. When the coil is energized, the normally open contacts are brought together; when the coil voltage is removed, the blades separate by their own spring tension. Some reeds contain permanent magnets for magnetic biasing to achieve normally closed contacts (SPST-NC) or SPDT contact combinations. The current rating, which is dependent upon the size of the blade and the type and amount of plating, may range from low level to 1 amp. Effective contact protection is essential when switching loads other than dry resistive loads.

## CONTACT COMBINATIONS.

The switches used in dry reed relays provide SPST-NO, SPST-NC, SPDT contact combinations. The SPST-NO corresponds with the basic switch capsule design (Fig.1). The SPST-NC results from a combination of the SPST-NO switch and a permanent magnet strong enough to pull the contacts closed but able to open when coil voltage is applied to the relay coil. In typical true SPDT designs, the armature is mechanically tensioned against the normally closed contact, and is moved to the normally open contact upon application of a magnetic field. The SPDT contact combination can also be achieved by joining a SPST-NO switch with an appropriately adjusted SPST-NC switch, and jumping one side of both switches together to form the movable contact system. Latching contacts, defined as contacts which remain in the position to which they were driven, and stay in that position when coil power is removed from the relay coil.

Latching switches are manufactured by using a SPST-NO contact, and biasing it with a permanent magnetic that is strong enough to hold the contacts closed, but not strong enough to hold the contact closed when coil power is applied to the coil. The switching process is then reversed by simply reversing the relay coil polarity to close the switch, or by employing a second coil with a reverse field.

## MAGNETIC FIELDS

Reed relays in general can be characterized as susceptible to the influences of external magnetic fields. It is important to keep reed relays at a proper distance from each other because of the possibility of magnetic-interaction between them. Proper magnetic shielding must be used to contain stray magnetic fields. When installing reed relays into equipment, one should be aware of the devices within that equipment which can produce magnetic fields. The relays being installed into that equipment should be positioned as far away as possible from any stray magnetic fields and should be shielded to prevent false operations.

## ELECTRICAL CHARACTERISTICS

**SENSITIVITY:** The input power required to operate dry reed relays is determined by the sensitivity of the particular reed switch used, by the number of switches operated by the coil, by the permanent magnet biasing (if used), and the efficiency of the coil and the effectiveness of its coupling to the blades. Minimum input required to effect closure ranges from the very low milliwatt level for a single sensitive capsule to several watts for multipole relays.

**OPERATE TIME:** The coil time constant, overdrive on the coil, and the characteristics of the reed switch determine operate time. With the maximum overdrive voltage applied to the coil, reed relays will operate in approximately the 200 microsecond range. When driven at rated coil voltage, usually the relays will operate at about one millisecond.

**RELEASE TIME:** With the coil unsuppressed, dry reed switch contacts release in a fraction of a millisecond. SPST-NO contacts will open in as little as 50 microseconds. Magnetically biased SPST-NC and SPDT switches reclose from 100 microseconds to 1 millisecond respectively. If the relay coil is suppressed, release times are increased. Diode suppression can delay release times for several milliseconds, depending on coil characteristics, coil voltage, and reed release characteristics.

## CONTACT BOUNCE

Dry reed contacts bounce on closure as with any other hard contact relay. The duration of bounce on a Dry reed switch is typically very short, and is in part dependent on drive level. In some of the faster devices, the sum of the operate time and bounce is relatively constant. As drive is increased, the operate time decreases with bounce time increasing. The normally closed contacts of a SPDT switch bounce more than the normally open contacts. Magnetically biased SPST-NC contacts exhibit essentially the same bounce characteristics as SPST-NO switches.

## APPLICATION DATA

### CONTACT RESISTANCE

The reeds (blades) in a dry reed switch are made of magnetic material which has a high volume resistivity, terminal-to-terminal resistance is somewhat higher than in some other types of relays. Typical specification limits for initial resistance of a SPST-NO reed relay is 0.200 ohms max (200 milliohms).

### INSULATION RESISTANCE

A dry reed switch made in a properly controlled internal atmosphere will have an insulation resistance of  $10^{12}$  to  $10^{13}$  ohms or greater. When it is assembled into a relay, parallel insulation paths reduce this to typical values of  $10^{13}$  ohms. Depending on the particular manner of relay construction, exposure to high humidity or contaminating environments can appreciably lower final insulation resistance.

### CAPACITANCE

Reed capsules typically have low terminal-to-terminal capacitance. However, in the typical relay structure where the switch is surrounded by a coil, capacitance from each reed to the coil act to increase capacitance many times. If the increased capacitance is objectionable, it can be reduced by placing a grounded electrostatic shield between the switch and coil.

### DIELECTRIC WITHSTAND VOLTAGE

With the exception of the High-Voltage dry reed switches (capsules that are pressurized or evacuated), the dielectric strength limitation of relays is determined by the ampere turn sensitivity of the switches used. A typical limit is 200 VAC. The dielectric withstand voltage between switch and coil terminals is typically 500 VAC.

### THERMAL EMF

Since thermally generated voltages result from thermal gradients within the relay assembly, relays built to minimize this effect often use sensitive switches to reduce required coil power, and thermally conductive materials to reduce temperature gradients. Latching relays, which may be operated by a short duration pulse, are often used if the operational rate is not changed for longer periods of time because coil power is not required to keep the relay in the on or off position after the initial turn on or turn off pulse.

### NOISE

Noise is defined as a voltage appearing between terminals of a switch for a few milliseconds following closure of the contacts. It occurs because the reeds (blades) are moving in a magnetic field and because voltages are produced within them by magnetostrictive effects. From an application standpoint, noise is important if the signal switched by the reed is to be used within a few milliseconds immediately following closure of the contacts. When noise is critical in an application, a peak-to-peak limit must be established by measurement techniques, including filters which must be specified for that particular switching application.

### ENVIRONMENTAL CHARACTERISTICS

Reed relays are used in essentially the same environments as other types of relays. Factors influencing their ability to function would be temperature extremes beyond specified limits

### VIBRATION

The reed switch structure, with so few elements free to move, has a better defined response to vibration than other relay types. With vibration inputs reasonably separated from the resonant frequency, the reed relay will withstand relatively high inputs, 20 g's or more. At resonance of the reeds, the typical device can fail at very low input levels. Typical resonance frequency is 2000 Hz.

### SHOCK

Dry reed relays will withstand relatively high levels of shock. SPST-NO contacts are usually rated to pass 30 to 50 g's, 11 milliseconds, half sine wave shock, without false operation of contacts. Switches exposed to a magnetic field that keep the contacts in a closed position, such as in the biased latching form, demonstrate somewhat lower resistance to shock. Normally closed contacts of mechanically biased SPDT switches may also fail at lower shock levels.

### TEMPERATURE

Differential expansion or contraction of reed switches and materials used in relay assemblies can lead to fracture of the switches. Reed relays are capable of withstanding temperature cycling or temperature shock over a range of at least -50 C to + 100 C. These limits should be applied to the application to prevent switch failure.

### CONTACT PROTECTION

Tungsten lamp, inductive and capacitive discharge load are extremely detrimental to reed switches and reduce life considerably. Illustrated below are typical suppression circuits which are necessary for maximum contact life.



Figure 3

Initial cold filament turn-on current is often 16 times higher than the rated operating current of the lamp. A current limiting resistor in series with the load, or a bleeder resistor across the contacts will suppress the inrush current. The same circuits can be used with capacitive loads, as shown in Figure 3.



Figure 4

DC inductive loads call for either a diode or a thyristor to be placed across the load. These circuits are necessary to protect the contacts when inductive loads are to be switched in a circuit, as shown in Figure 4.

勝特力材料 886-3-5753170  
 勝特力电子(上海) 86-21-54151736  
 勝特力电子(深圳) 86-755-83298787  
 Http://www.100y.com.tw

## OUTLINE DIMENSIONS

DIMENSIONS SHOWN IN INCHES & (MILLIMETERS).

### 107DIP, 171DIP, 172DIP(SPDT)

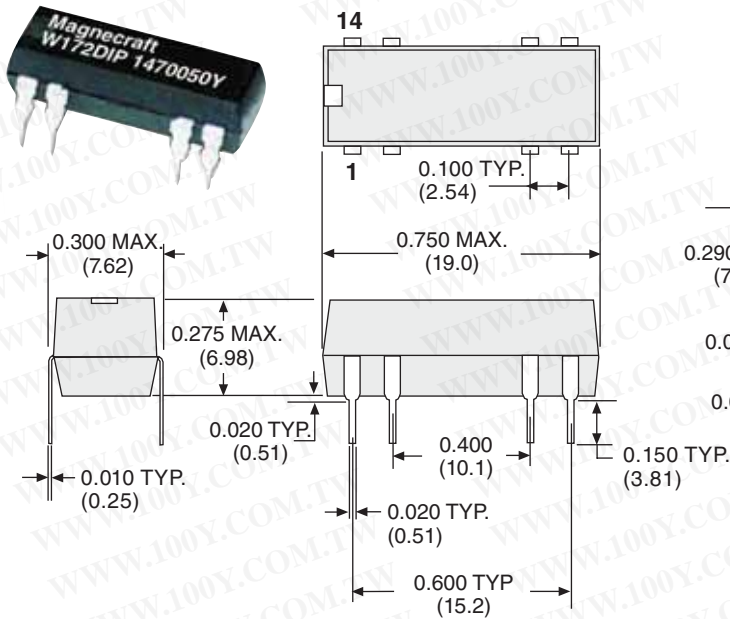

### 117SIP

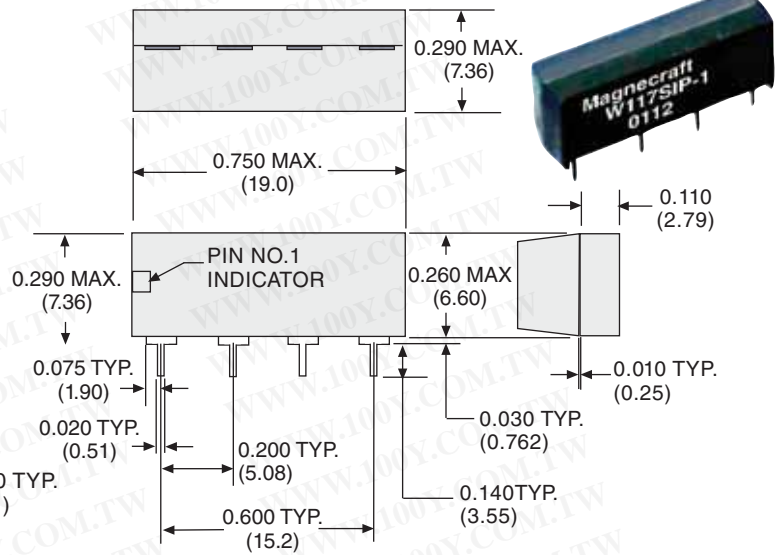

### 172DIP (DPDT)

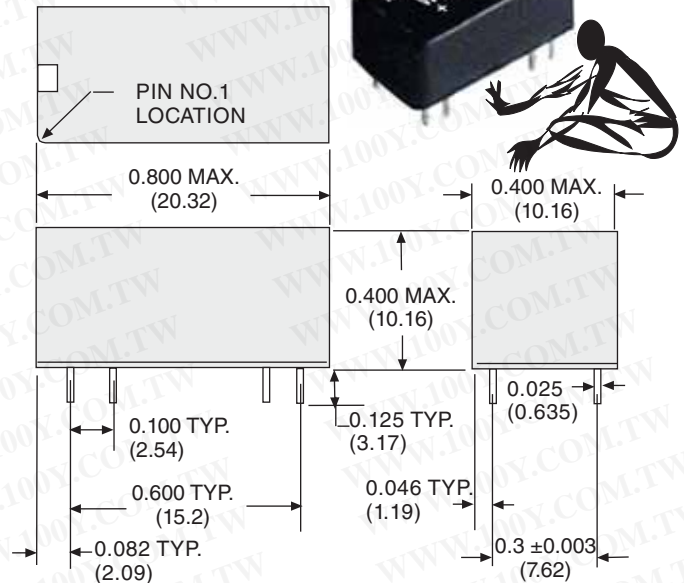

## GENERAL SPECIFICATIONS (@ 25°C)

	UNITS	
<b>COIL</b>		
Pull-in Voltage AC (50/60 Hz):	% of nominal	Not applicable
Pull-in Voltage DC:	% of nominal	80
Dropout Voltage AC (50/60 Hz):	% of nominal	Not applicable
Dropout Voltage DC:	% of nominal	10
Maximum Voltage:	% of nominal	110
Resistance:	% ±	10
Coil Power AC (60 Hz):	VA	Not applicable
Coil Power DC:	W	117SIP, 107DIP: 0.050 to 0.288 171DIP: 0.050 to 0.270 172DIP: 0.125 to 0.540
<b>CONTACTS</b>		
Contact Material:		RHODIUM
Contact Rating AC Amperes (AC1):	A	117SIP, 107DIP, 171DIP: 0.5 172 DIP: 0.25
Contact Rating AC Voltage:	V	117SIP, 107DIP: 120 171DIP, 172 DIP: 60
Contact Rating DC Amperes (DC1):	A	0.5
Contact Rating DC Voltage:	V	100
Contact Rating :	VA	117SIP, 107DIP, 171DIP: 10 172 DIP: SPDT 4, DPDT 10
General Purpose Rating (75%-80%):		Not applicable
Horse Power (AC):	HP	Not applicable
Pilot Duty (60 Hz):		Not applicable
VA Rating Make:	VA	Not applicable
VA Rating Break:	VA	Not applicable
Minimum Recommended Load:	ma	10 or 0.05 Watt
<b>TIMING</b>		
Operate Time:	ms	1
Release Time:	ms	1
<b>DIELECTRIC STRENGTH</b>		
Coil to Contacts:	V rms	500
Across Open Contacts:	V rms	150
Pole to Pole:	V rms	Not applicable
Contacts to Frame:	V rms	Not applicable
Insulation Resistance:	megohms minimum @VDC	1000 @ 500
<b>VIBRATION RESISTANCE</b>		
Functional:	g's	20

	UNITS	
<b>SHOCK RESISTANCE</b>		
Functional:	g's	50
<b>TEMPERATURE</b>		
Operating, AC Lower:	°C	Not applicable
Operating, AC Upper:	°C	Not applicable
Operating, DC Lower:	°C	-40
Operating, DC Upper:	°C	+85
Storage, Lower:	°C	-40
Storage, Upper:	°C	+105
<b>LIFE EXPECTANCY</b>		
Electrical @ Rated Load (AC1):	operations	50,000,000
Mechanical @ no Load :	operations	100,000,000
<b>MISCELLANEOUS</b>		
Operating Position:		Any
Insulation Material:		Glass
Enclosure Material:		Thermo set plastic
Cover Protection Category:	IP	67
Weight:	grams	1

# SIP & DIP MINIATURE REED RELAYS



## SPST NO OR NC, DPST NO, 0.5 AMP

勝特力材料 886-3-5753170  
 勝特力电子(上海) 86-21-54151736  
 勝特力电子(深圳) 86-755-83298787  
 Http://www.100y.com.tw

### WIRING DIAGRAM (TOP VIEWED)

117SIP



STANDARD PART NUMBERS	COIL MEASURED @ 25 °C		
	NOMINAL INPUT VOLTAGE	NOMINAL RESISTANCE (OHMS)	NOMINAL POWER (mW)
<b>SPST - N. O., 0.5 AMP</b>			
W117SIP-1	5	500 Ω	50
W117SIP-3	12	1000 Ω	144
W117SIP-5	24	2000 Ω	288
<b>SPST - N. C., 0.5 AMP</b>			
W117SIP-22	5	500 Ω	50
W117SIP-23	12	1200 Ω	120
W117SIP-24	24	2200 Ω	270

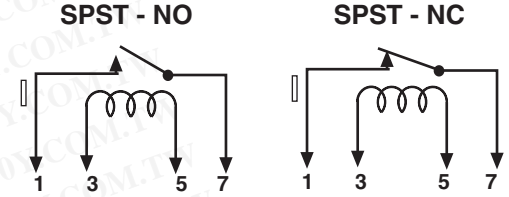

<b>SPST - N. O. WITH CLAMPING DIODE, 0.5 AMP</b>			
W117SIP-6	5	500 Ω	50
W117SIP-8	12	1000 Ω	144
W117SIP-10	24	2000 Ω	288
<b>SPST - N. C. WITH CLAMPING DIODE, 0.5 AMP</b>			
W117SIP-18	5	500 Ω	50
W117SIP-25	12	1200 Ω	120
W117SIP-26	24	2200 Ω	220

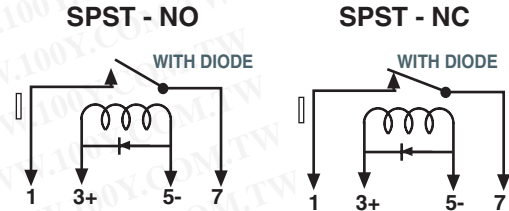

107DIP



<b>SPST - N. O., 0.5 AMP</b>			
W107DIP-1	5	500 Ω	50
W107DIP-3	12	1000 Ω	144
W107DIP-4	24	2000 Ω	288
<b>SPST - N. O. WITH CLAMPING DIODE, 0.5 AMP</b>			
W107DIP-5	5	500 Ω	50
W107DIP-7	12	1000 Ω	144
W107DIP-8	24	2000 Ω	288

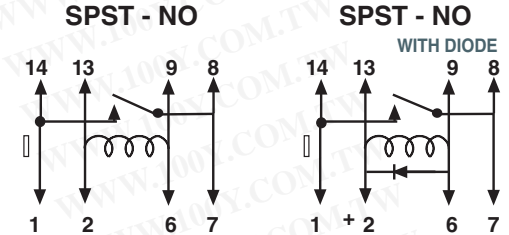

<b>SPST - N. O., 0.5 AMP</b>			
W171DIP-2	5	500 Ω	50
W171DIP-4	12	1200 Ω	120
W171DIP-5	24	2200 Ω	270
<b>SPST - N. O. WITH CLAMPING DIODE, 0.5 AMP</b>			
W171DIP-7	5	500 Ω	50
W171DIP-9	12	1000 Ω	144
W171DIP-10	24	2200 Ω	270

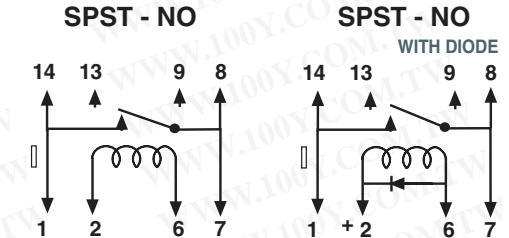

171DIP



<b>SPST - N. C., 0.5 AMP</b>			
W171DIP-12	5	200 Ω	50
W171DIP-14	12	1200 Ω	120
W171DIP-15	24	2200 Ω	270
<b>SPST - N. C. WITH CLAMPING DIODE, 0.5 AMP</b>			
W171DIP-17	5	500 Ω	50
W171DIP-19	12	1200 Ω	120
W171DIP-20	24	2200 Ω	270

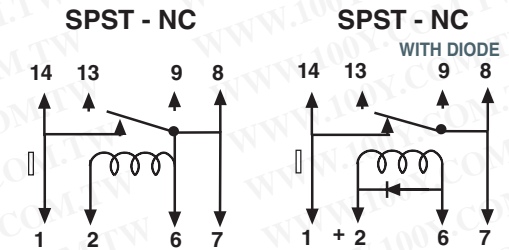

<b>DPST - N. O., 0.5 AMP</b>			
W171DIP-21	5	500 Ω	50
W171DIP-23	12	1000 Ω	144
W171DIP-24	24	2200 Ω	270
<b>DPST - N. O. WITH CLAMPING DIODE, 0.5 AMP</b>			
W171DIP-25	5	500 Ω	50
W171DIP-27	12	1000 Ω	144
W171DIP-28	24	2200 Ω	270

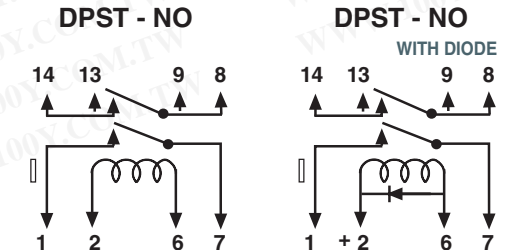

WHEN SPACING SIP RELAYS, THE RELAYS REQUIRE 1/2 INCH SPACING FROM THE SIDE OF THE ADJACENT RELAYS.

# DIP MINIATURE REED RELAYS



## SPDT NO, DPDT, 0.25 AMP

### WIRING DIAGRAM (TOP VIEWED)



STANDARD PART NUMBERS	COIL MEASURED @ 25 °C		
	NOMINAL INPUT VOLTAGE	NOMINAL RESISTANCE (OHMS)	NOMINAL POWER (mW)
<b>SPDT, 0.25 AMP</b>			
W172DIP-1	5	200 Ω	125
W172DIP-3	12	500 Ω	300
W172DIP-4	24	2200 Ω	270
<b>SPDT WITH CLAMPING DIODE, 0.25 AMP</b>			
W172DIP-5	5	200 Ω	125
W172DIP-7	12	500 Ω	300
W172DIP-8	24	2200 Ω	270

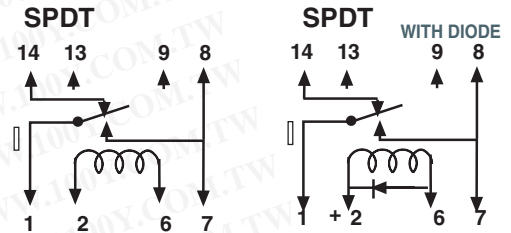

<b>SPDT, 0.25 AMP</b>			
W172DIP-31	5	200 Ω	125
W172DIP-33	12	500 Ω	290
W172DIP-34	24	2200 Ω	270
<b>SPDT WITH CLAMPING DIODE, 0.25 AMP</b>			
W172DIP-35	5	200 Ω	125
W172DIP-37	12	500 Ω	290
W172DIP-38	24	2200 Ω	270

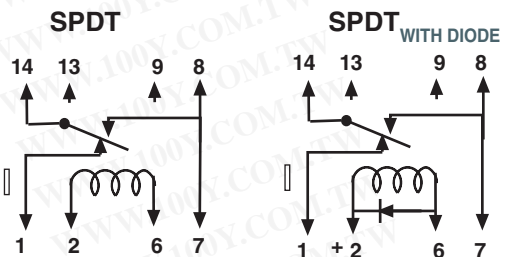

<b>SPDT, 0.25 AMP</b>			
W172DIP-141	5	200 Ω	125
W172DIP-145	12	1000 Ω	144
W172DIP-146	24	3200 Ω	180
<b>SPDT WITH CLAMPING DIODE, 0.25 AMP</b>			
W172DIP-147	5	200 Ω	125
W172DIP-149	12	1000 Ω	144
W172DIP-150	24	3200 Ω	180

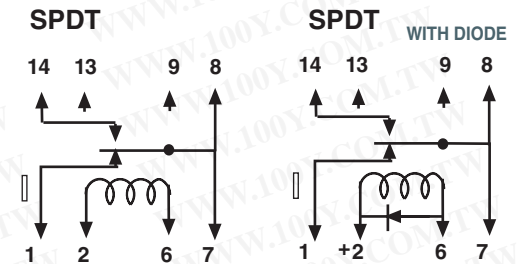

<b>DPDT, 0.25 AMP</b>			
W172DIP-17	5	46 Ω	540
W172DIP-19	12	266 Ω	540
W172DIP-20	24	1066 Ω	540
<b>DPDT WITH CLAMPING DIODE, 0.25 AMP</b>			
W172DIP-21	5	46 Ω	540
W172DIP-23	12	266 Ω	540
W172DIP-24	24	1066 Ω	540

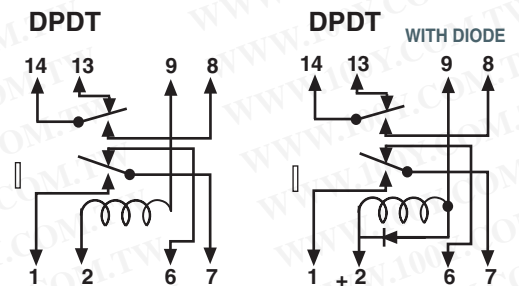

SEE END OF SECTION 6 FOR CROSS REFERENCE

勝特力材料 886-3-5753170  
 勝特力电子(上海) 86-21-54151736  
 勝特力电子(深圳) 86-755-83298787  
[Http://www.100y.com.tw](http://www.100y.com.tw)

WHEN SPACING DIP RELAYS, THE RELAYS REQUIRE 1/2 INCH SPACING FROM THE SIDE OF THE ADJACENT RELAYS.

