

Solid State Relays

G3NB-1

勝特力材料 886-3-5753170
 勝特力电子(上海) 86-21-34970699
 勝特力电子(深圳) 86-755-83298787
[Http://www.100y.com.tw](http://www.100y.com.tw)

SSR with output (5 to 90 A) at a reasonable price

- Zero cross function enables less noise operation.
- Built-in varistor effectively absorbs external surges.
- Operation indicator enables monitoring operation.
- Protective cover for greater safety.
- Certified by UL, CSA and TÜV.



Model Number Structure

Model Number Legend

G3NB-□□□□-□
 1 2 3 4 5

1. Basic Model Name

G3NB: Solid State Relay

2. Rated Load Power Supply Voltage

2: 220 VAC

3. Rated Load Current

05: 5 A
 10: 10 A
 20: 20 A
 25: 25 A
 40: 40 A
 75: 75 A
 90: 90 A

4. Terminal Type

B: Screw terminals

5. Certification

1: Standard models
 (UL, CSA and TÜV certification)

Ordering Information

■ List of Models

Isolation	Zero cross function	Indicator	Applicable output load (See note 2.)	Rated input voltage	Model
Photocoupler	Yes	Yes	5 A at 24 to 220 VAC	5 to 24 VDC	G3NB-205B-1 5 to 24 VDC
			10 A at 24 to 220 VAC		G3NB-210B-1 5 to 24 VDC
			20 A at 24 to 220 VAC		G3NB-220B-1 5 to 24 VDC
			25 A at 24 to 220 VAC		G3NB-225B-1 5 to 24 VDC
			40 A at 24 to 220 VAC		G3NB-240B-1 5 to 24 VDC
			75 A at 24 to 220 VAC		G3NB-275B-1 5 to 24 VDC
			90 A at 24 to 220 VAC		G3NB-290B-1 5 to 24 VDC

Note: 1. All models are certified by UL, CSA and TÜV.

2. The applicable output load depends on the ambient temperature. Refer to "Load Current vs. Ambient Temperature" in Engineering Data.

■ Accessories (Order Separately)

One-touch Mounting Plates

Model
R99-12 FOR G3NA

Mounting Bracket

Model
R99-11

Heat Sinks

Slim Models Enabling DIN-track Mounting

Model	Applicable SSR
Y92B-N50	G3NB-205B-1
	G3NB-210B-1
Y92B-N100	G3NB-220B-1
Y92B-N150	G3NB-225B-1
	G3NB-240B-1
Y92B-P250NF	G3NB-275B-1
	G3NB-290B-1

Specifications

■ Ratings

Input (at an Ambient Temperature of 25°C)

Rated voltage	Operating voltage	Rated input current	Voltage level	
			Operation voltage	Release voltage
5 to 24 VDC	4 to 32 VDC	7 mA max.	4 VDC max.	1 VDC min.

Output

Model	Applicable load				
	Rated load voltage	Load voltage range	Load current (See note 1.)		Inrush current
			With heat sink (See note 2.)	Without heat sink	
G3NB-205B-1	24 to 220 VAC	19 to 286 VAC	0.1 to 5 A (at 40°C)	0.1 to 3 A (at 40°C)	60 A (60 Hz, 1 cycle)
G3NB-210B-1			0.1 to 10 A (at 40°C)	0.1 to 4 A (at 40°C)	150 A (60 Hz, 1 cycle)
G3NB-220B-1			0.1 to 20 A (at 40°C)		220 A (60 Hz, 1 cycle)
G3NB-225B-1			0.1 to 25 A (at 40°C)		220 A (60 Hz, 1 cycle)
G3NB-240B-1			0.1 to 40 A (at 40°C)	0.1 to 6 A (at 40°C)	410 A (60 Hz, 1 cycle)
G3NB-275B-1			1 to 75 A (at 40°C)	1 to 7 A (at 40°C)	800 A (60 Hz, 1 cycle)
G3NB-290B-1			1 to 90 A (at 40°C)		900 A (60 Hz, 1 cycle)

Note: 1. The load current varies depending on the ambient temperature. Refer to *Load Current vs. Ambient Temperature* under *Engineering Data*.
 2. When an OMRON Heat Sink (refer to *Options*) or a heat sink of the specified size is used.

■ Characteristics

Item	G3NB-205B-1	G3NB-210B-1	G3NB-220B-1	G3NB-225B-1	G3NB-240B-1	G3NB-275B-1	G3NB-290B-1
Operate time	1/2 of load power source cycle + 1 ms max.						
Release time	1/2 of load power source cycle + 1 ms max.						
Output ON voltage drop	1.6 V (RMS) max.						
Leakage	5 mA max. (at 100 VAC), 10 mA max. (at 200 VAC)						
Insulation resistance	100 MΩ min. (at 500 VDC)						
Dielectric strength	2,500 VAC, 50/60 Hz for 1 min						
Vibration resistance	Destruction: 10 to 55 to 10 Hz, 0.35-mm single amplitude (0.7-mm double amplitude)						
Shock resistance	Destruction: 1,000 m/s ²						
Ambient temperature	Operating: -30 to 80°C (with no icing or condensation) Storage: -30 to 100°C (with no icing or condensation)						
Ambient humidity	Operating: 45% to 85%						
Weight	Approx. 60 g (G3NB-205B-1 ~ 225B), 80 g (G3NB-240B-1), 110 g (G3NB-275B-1 ~ 290B-1)						

Engineering Data

Load Current vs. Ambient Temperature

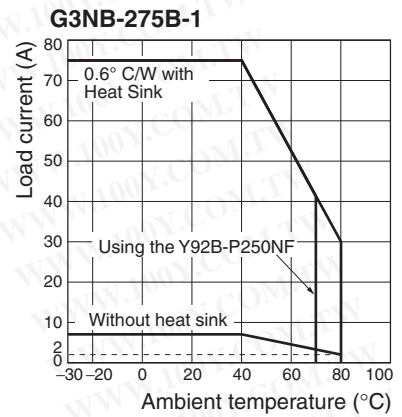
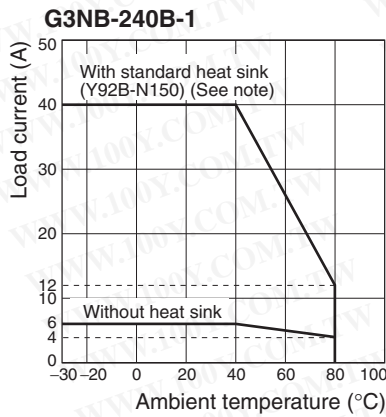
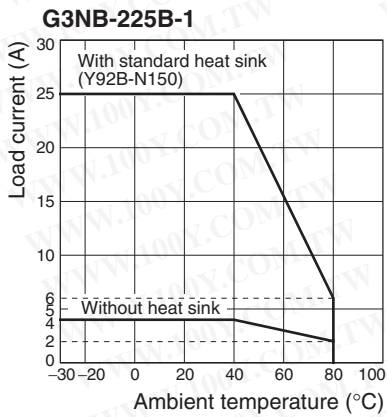
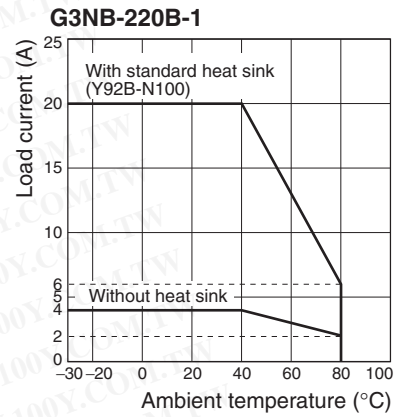
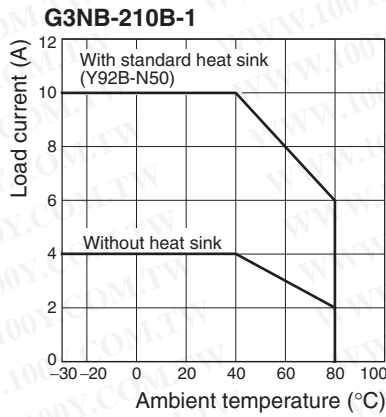
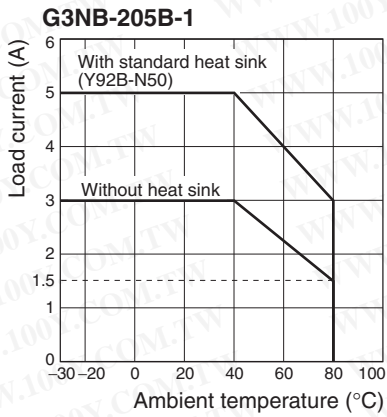

Note: Ventilated of FAN; 0.22 m³/min

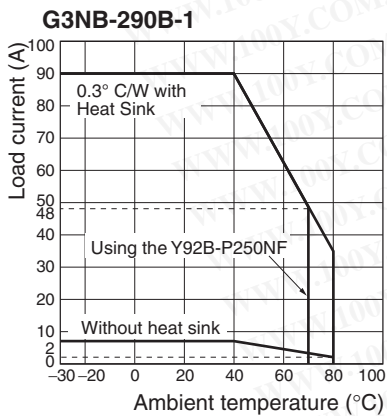

One Cycle Surge Current

G3NB-205B-1

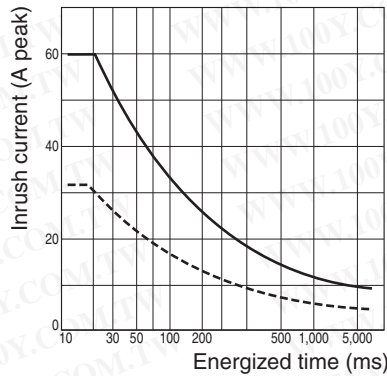

G3NB-210B-1

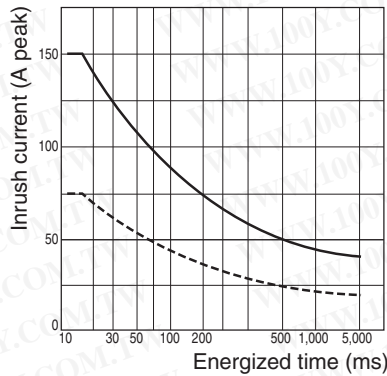

G3NB-220B-1
G3NB-225B-1

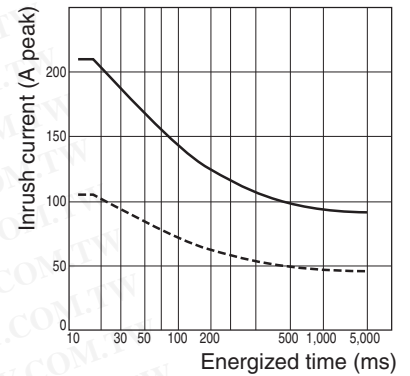

G3NB-240B-1

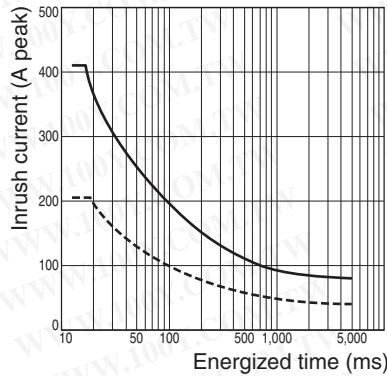

G3NB-275B-1

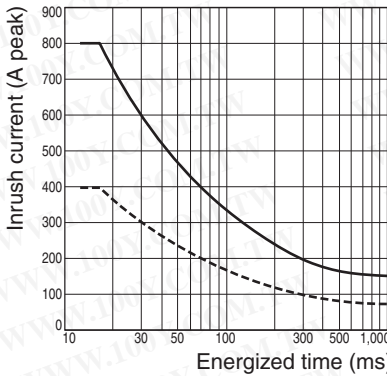

G3NB-290B-1

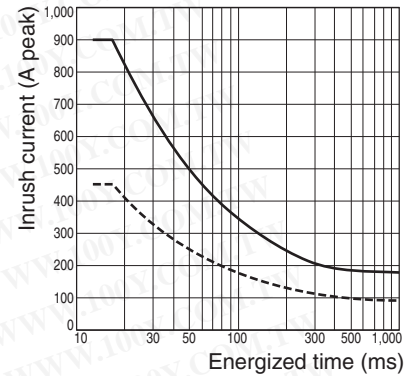

Thermal Resistance Rth of Heat Sinks (Examples)

Model	Rth (°C/W)
Y92B-N50	2.80
Y92B-N100	1.63
Y92B-N150	1.38
Y92B-A100	1.63
Y92B-A150N	1.37
Y92B-P250NF	0.46

Dimensions

Relays

Note: All units are in millimeters unless otherwise indicated.

G3NB-205B-1
G3NB-210B-1
G3NB-220B-1
G3NB-225B-1

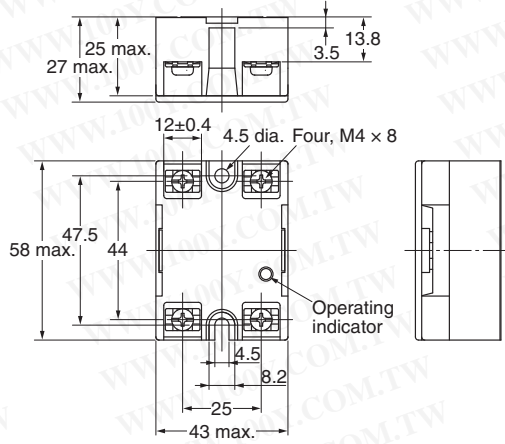

Mounting Holes

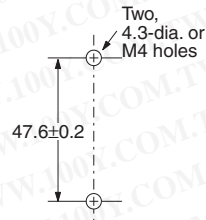

Terminal Arrangement/ Internal Connections (Top View)

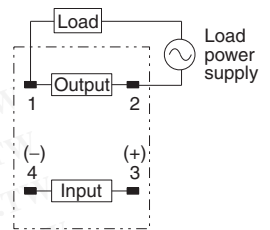

G3NB-240B-1

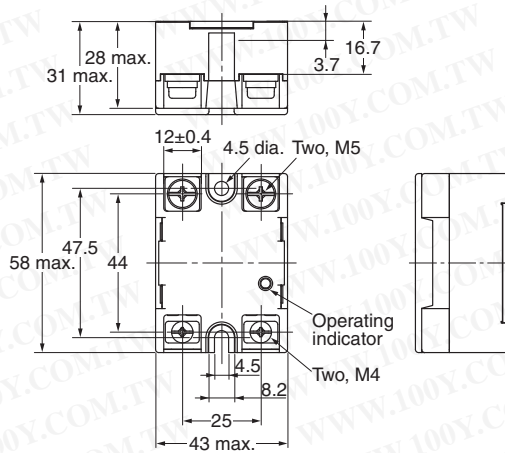

Mounting Holes

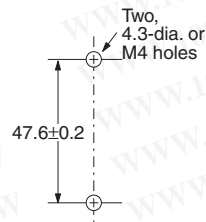

Terminal Arrangement/ Internal Connections (Top View)

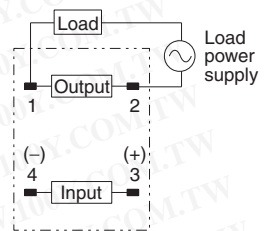

G3NB-275B-1
G3NB-290B-1

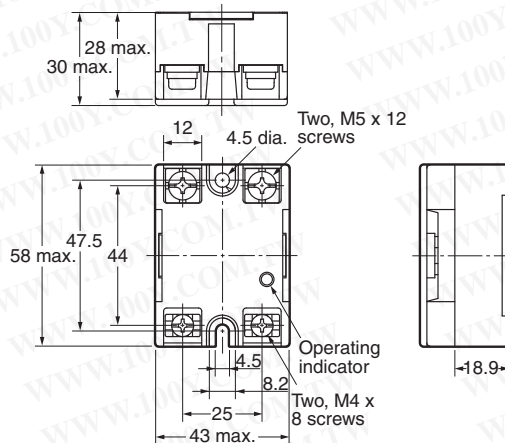

Mounting Holes

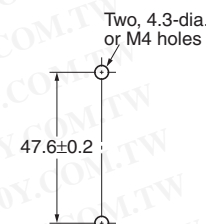

Terminal Arrangement/ Internal Connections (Top View)

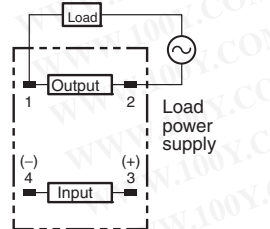

Options (Order Separately)

One-touch Mounting Plate

The One-touch Mounting Plate is used to mount the G3NB to a DIN Track.

R99-12 FOR G3NA

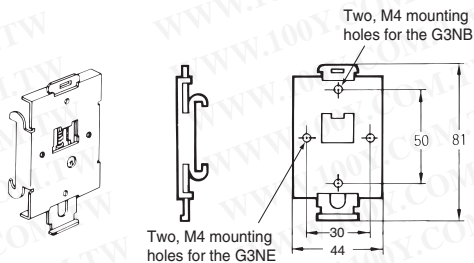

To mount the Relay to DIN Track, first mount it to the One-touch Mounting Plate and then attach it to the DIN Track as shown in the diagram.

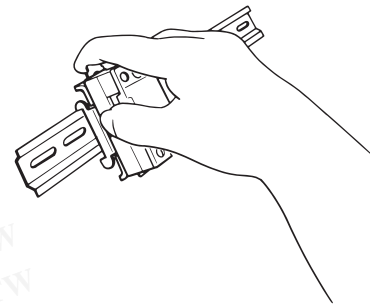

To remove the Relay from the DIN Track, pull down on the tab with a screwdriver in the direction of the arrow.

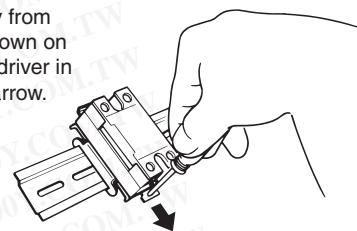

- When a Relay is mounted to DIN Track, use it within the rating for a Relay without a heat sink.
- Use the following DIN Tracks: PFP-100N or PFP-100N2.

Heat Sinks

Y92B-N50 Heat Sink (for the G3NB-205B-1, G3NB-210B-1)

For surface mounting, a 30% derating of the load current is required (from the *Load Current vs. Ambient Temperature* graphs). For mounting method, refer to "Precautions for Correct Use".

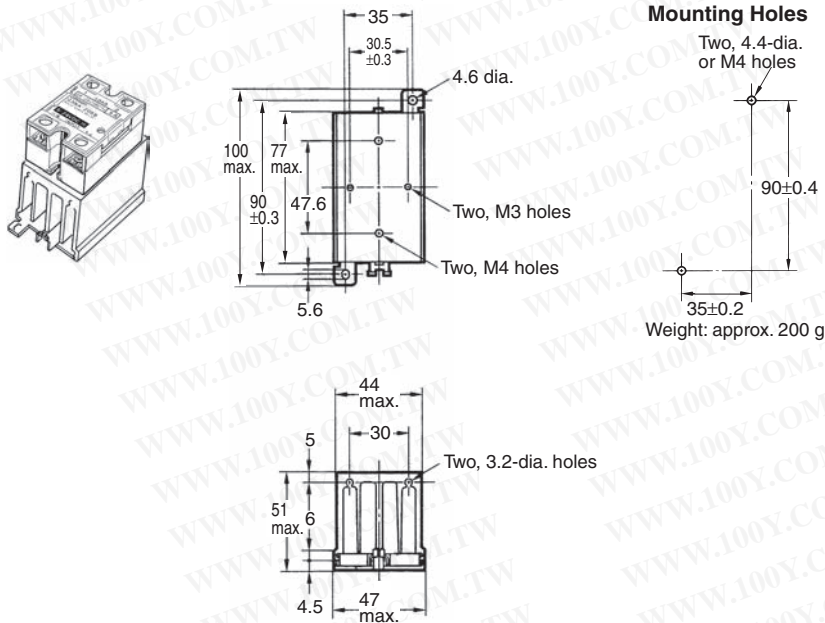

Y92B-N100 Heat Sink (for the G3NB-220B-1)

For surface mounting, a 30% derating of the load current is required (from the *Load Current vs. Ambient Temperature* graphs).
For mounting method, refer to "Precautions for Correct Use".

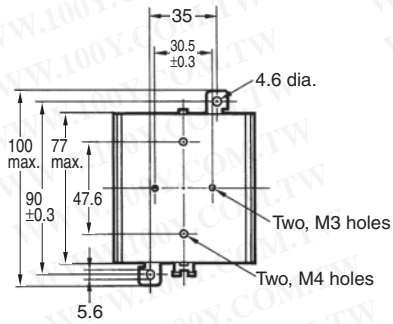
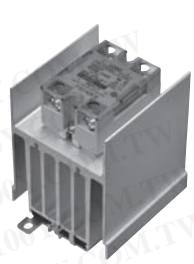

Mounting Holes

Two, 4.4-dia. or M4 holes

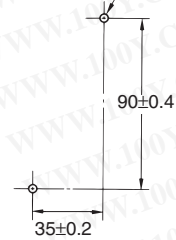

Weight: approx. 400 g

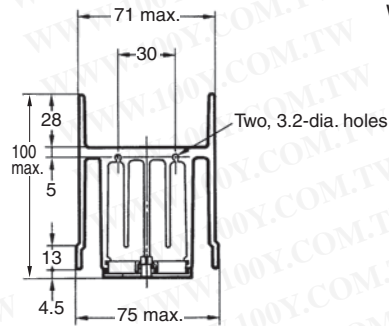

Y92B-N150 Heat Sink (for the G3NB-225B-1, G3NB-240B-1)

For surface mounting, a 30% derating of the load current is required (from the *Load Current vs. Ambient Temperature* graphs).
For mounting method, refer to "Precautions for Correct Use".

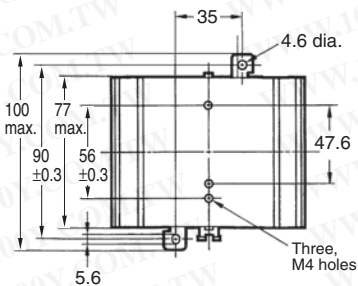
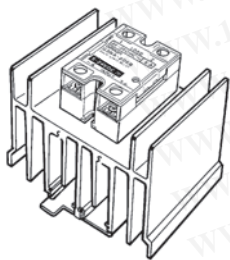

Mounting Holes

Two, 4.4-dia. or M4 holes

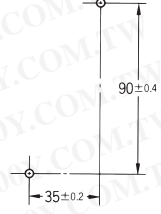

Weight: approx. 560 g

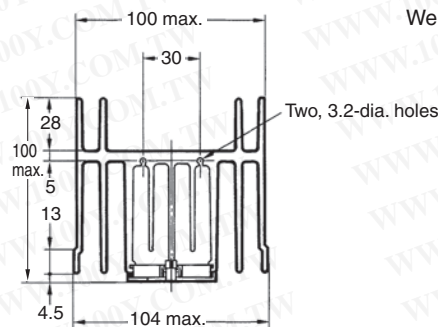

Y92B-P250NF Heat Sink (for the G3NB-275B-1, G3NB-290B-1)

For mounting method, refer to "Precautions for Correct Use".

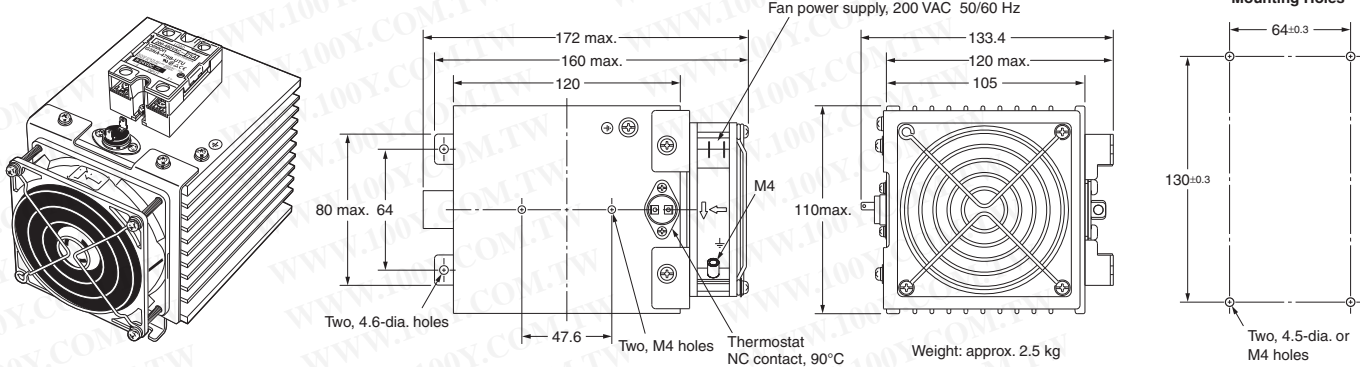

Safety Precautions

CAUTION

Installation and Installation Environment

- Be sure to conduct wiring with the power supply turned OFF, and always attach the terminal cover after completing wiring. Touching the terminals when they are charged may occasionally result in minor electric shock.
- The G3NB may rupture if a short-circuit is applied to it. To protect against short-circuit accidents, install a protective device, such as a quick-burning fuse, on the power supply line.



Maintenance

- The internal snubber circuit is charged and may occasionally cause minor electric shock. Do not touch the G3NB's main circuit terminals immediately after the power is turned OFF.
- The G3NB and heat sink will be hot and may occasionally cause minor burns. Do not touch the G3NB or the heat sink either while the power supply is ON, or immediately after the power is turned OFF.



Important Notice

1. The standard G3NB models are equipped with a varistor as a surge absorber.

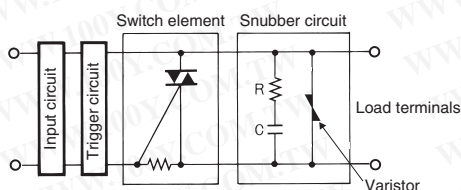

2. All G3NB-1 models are equipped a terminal cover. (Except G3NB-240B)
3. The reliability of the output device of the G3NA-240B is better than that of the G3NB. The output device of the G3NB is different from that of the G3NA-240B. If you need higher reliability, we recommend using the G3NA-240B.

	Load current of SSR (at 40°C) with standard heatsink	Rated current of output device
G3NB-240B	40 A max.	40 A max.
G3NB-225B	25 A max.	25 A max.
G3NA-240B	40 A max.	50 A max.

Precautions for Safe Use

Transport

Do not transport the G3NB under the following conditions. Failure, malfunction, or deterioration of performance characteristics may occur.

- Conditions under which the G3NB will be exposed to water or oil
- High temperatures or high humidity
- Without proper packing
- Conditions under which rapid temperature changes may occur, resulting in the formation of condensation.

Use and Storage

Do not use or store the G3NB in the following locations. Doing so may result in damage, malfunction, or deterioration of performance characteristics.

- Do not use or store in locations subject to rain or water drops.
- Do not use or store in locations subject to exposure to water, oil, or chemicals.
- Do not use or store in locations subject to high temperatures or high humidity.
- Do not store in locations subject to ambient temperatures outside the range -30 to 100°C.
- Do not use in locations subject to relative humidity outside the range 45% to 85%.
- Do not use in locations subject to condensation as the result of severe changes in temperature.
- Do not use or store in locations subject to corrosive or flammable gases.
- Do not use or store in locations subject to dust (especially iron dust) or salts or in locations subject to salt damage.
- Do not use or store in locations subject to direct sunlight.
- Do not use or store in locations subject to shock or vibration.

Use and Handling

- Do not obstruct the airflow to the G3NB or heat sink. Heat generated from an G3NB error may occasionally cause the output element to short, or cause fire damage.
- Do not mount the G3NB when your hands are oily or dirty, e.g., with metal powder. These may cause G3NB failure.

Use and Installation

- Mount the G3NB in the specified orientation. If the G3NB is mounted in any other orientation, abnormal heat generation may cause output elements to short or may cause burning.
- Be sure to prevent the ambient temperature from rising due to the heat radiation of the G3NB. If the G3NB is mounted inside a panel, install a fan so that the interior of the panel is fully ventilated.
- When mounting the G3NB to a heat sink or radiator, apply a thin layer of Momentive Performance Materials Inc.'s YG6260 or Sinetsu Silicone's G746, or a similar product, to the mounting surfaces prior to mounting.
- If a material with high thermal resistance, such as wood, is used, heat generated by the G3NB may occasionally cause fire or burning. When installing the G3NB directly into a control panel so that the panel can be used as a heat sink, use a panel material with low thermal resistance, such as aluminum or steel.
- Use the specified heat sink or one with equivalent or better characteristics. Failure to do so may result in short-circuiting or burning of the output elements due to abnormal heating.
- Tighten the G3NB screws securely when mounting the G3NB. Tightening torque: 0.78 to 0.98 N·m
- Tighten the heat sink screws securely when mounting the G3NB. Tightening torque: 0.98 to 1.47 N·m

Use and Wiring

- Abnormal heat generated by wires may occasionally result in burning damage or melting of the wire sheath, leading to electric shock. Use wires suitable for the load current.
- Do not use any wires with damaged sheaths. These may cause electric shock or leakage.
- Do not place wiring in the same conduit or duct as high-voltage lines. Induction may cause malfunction or damage.
- Use wires of an appropriate length, otherwise improper operation, malfunction and burning may result due to induction.
- Heat generated by a terminal error may occasionally result in fire damage. Do not operate if the screws on the terminal are loose.

Screw terminal's Tightening Torque

Screw size	Tightening torque
M4	0.98 to 1.47 N·m
M5	1.57 to 2.45 N·m

- Abnormal heat generated by terminals may occasionally result in fire damage. When tightening terminal screws, be sure that no non-conductive foreign matter is caught in screw.
- Turn OFF the power before doing any wiring work. Failure to do so may cause electric shock.

Use

- Only use the G3NB with loads that are within the rated values. Using the G3NB with loads outside the rated values may result in malfunction, damage, or burning.
- Use a power supply within the rated frequency range. Using a power supply outside the rated frequency range may result in malfunction, damage, or burning.
- Use crimp terminals of an appropriate size for the wire diameter. Failure to do so may occasionally result in burning damage or melting of the wire sheath, leading to electric shock.
- G3NB malfunction or fire damage may occasionally occur. Do not apply excessive voltage or current to the G3NB terminals.

Precautions for Correct Use

- Do not drop the G3NB or subject it to strong vibration during transport or installation, or this may adversely affect the characteristics or cause improper operation or malfunction.
- Do not transport the G3NB in an unpackaged condition, or this may cause damage or malfunction.
- Do not allow solvents, such as thinner or gasoline, to come into contact with any resin parts on the G3NB, or this may cause the markings on the G3NB to rub off.
- Do not allow oil to come into contact with the cover of the terminal block on the G3NB, or this may cause the cover to turn whitish or crack.

Mounting Orientation

When mounting the G3NB to a flat surface, refer to *Load Current vs. Ambient Temperature* to reduce the load current by 30%.

Output Noise Surges for AC Switching SSRs

Connect a surge absorber (varistor) to both ends of the SSR load, and in parallel with the load. Use varistors with the following elements.

Line Voltage	Varistor Voltage	Surge Capacity
100 to 120 VAC	240 to 270 V	1,000 A min.
200 to 240 VAC	430 to 470 V	1,000 A min.

Control Panel Installation

Installing an SSR in a closed control panel will cause the heat that is generated by the SSR to accumulate inside the panel, which may lessen the SSR's flow of current or possibly have adverse effects on other electronic components inside the panel.

Be sure to provide ventilation holes at the top and bottom of the control panel. The use of fans is recommended as a more effective means of ventilation.

SSR Mounting Pitch (Panel Mounting)

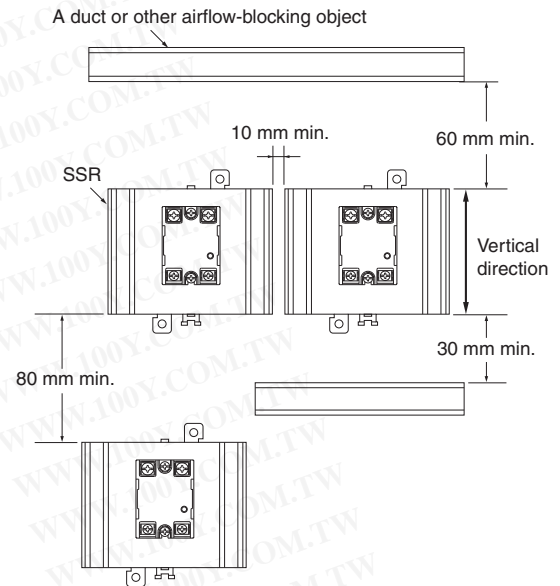

Relationship between SSRs and Duct Depth

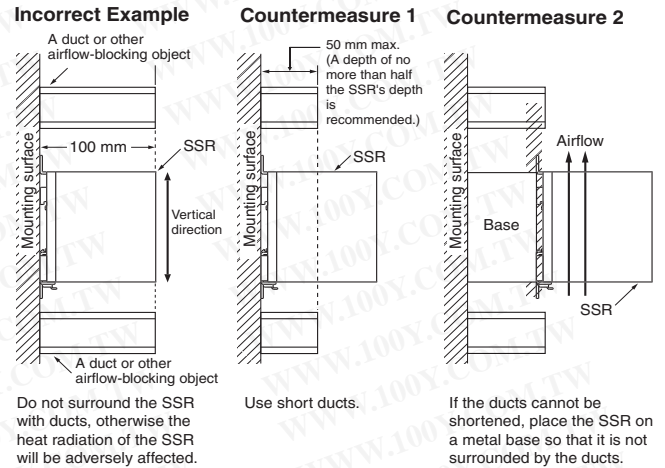

Ventilation Outside the Control Panel

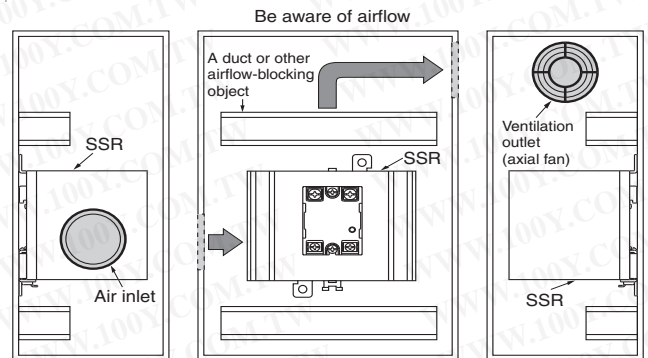

- Note:**
- If the air inlet or air outlet has a filter, clean the filter regularly to prevent it from clogging to ensure an efficient flow of air.
 - Do not locate any objects around the air inlet or air outlet, otherwise the objects may obstruct the proper ventilation of the control panel.
 - A heat exchanger, if used, should be located in front of the SSRs to ensure the efficiency of the heat exchanger.

SSR Ambient Temperature

The rated load current of an SSR is measured at an ambient temperature of 40°C.

An SSR uses a semiconductor in the output element. This causes the temperature inside the control panel to increase due to heating resulting from the passage of electrical current through the load. To restrict heating, attach a fan to the ventilation outlet or air inlet of the control panel to ventilate the panel. This will reduce the ambient temperature of the SSRs and thus increase reliability. (Generally, each 10°C reduction in temperature will double the expected life, according to the Arrhenius Equation.)

SSR rated current (A)	5 A	10 A	20 A	25 A	40 A	75 A	90 A
Required number of fans per SSR	0.08	0.16	0.31	0.4	0.62	1.2	1.44

Example: For ten SSRs with load currents of 40 A,
 $0.62 \times 10 = 6.2$
 Thus, seven fans would be required.

- Note:**
1. Size of fans: 92 mm², Air volume: 0.7 m³/min, Ambient temperature of control panel: 30°C
 2. If there are other instruments that generate heat in the control panel other than SSRs, additional ventilation will be required.

Operating Conditions

- As protection against accidents due to short-circuiting, be sure to install protective devices, such as fuses and no-fuse breakers, on the power supply side.
- Do not apply overvoltages to the input circuit or output circuit. Failure or burning may result.
- Keep the cooling system running continuously during the ON/OFF operation of the SSR. This is to allow residual heat to dissipate while the SSR is OFF.

Operating Ambient Temperature

The rated value for the ambient operating temperature of the G3NB is for when there is no heat build-up. For this reason, under conditions where heat dissipation is not good due to poor ventilation, and where heat may build up easily, the actual temperature of the G3NB may exceed the rated value resulting in malfunction or burning.

When using the G3NB, design the system to allow heat dissipation sufficient to stay below the *Load Current vs. Ambient Temperature* characteristic curve. Note also that the ambient temperature of the G3NB may increase as a result of environmental conditions (e.g., climate or air-conditioning) and operating conditions (e.g., mounting in an airtight panel).

Safety Specifications

Output-circuit

Item	205B	210B	220B	225B	240B	275B	290B
Classification	IEC 60947-4-3						
Rated conditional short circuit current	3000 A						
Short circuit protective device	10 A	32 A		63 A	100 A		
Short circuit coordination	type 1						

General

Classification	IEC 60947-4-3
Ambient temperature	-30 to 80°C
Insulation system	Basic
Rated Insuration voltage	Main: 250V Control: 24V
Rated Impulse withstand voltage	Main: 4kV Control: 0.8kV
Pollution degree	2
IP code	IP 10

< For use in class I equipment >

Metal mounting supports must be sufficiently bonded to the PE-conductor.

If a mounting rail is used, the rail must be provided with an individual connection to the PE conductor.

This can be achieved by using Protective Conductor Terminal Blocks in accordance with IEC 60947-7-2 or other means providing equivalent reliability.

EMC Directive Compliance

EMC directives can be complied with under the following conditions.

- A capacitor must be connected to the input power supply.
- A capacitor and varistor must be connected to the load power supply.
- The input cable must be less than 3 m.

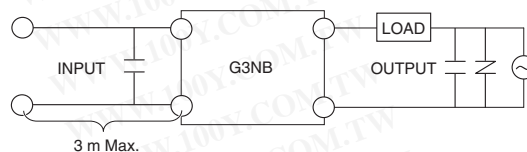

Recommended Capacitor (Film Capacitor) Load: 0.1 μF, 275 VAC
 Input: 1.0 μF, 275 VAC
 Varistor : 390 V, 25000 A

EMI

This is a class A product. In residential areas it may cause radio interference, in which case the user may be required to take adequate measures to reduce interference.

Loss Time

The loss time will increase when the G3NB is used at a low applied voltage or current. Be sure that this does not cause any problems.

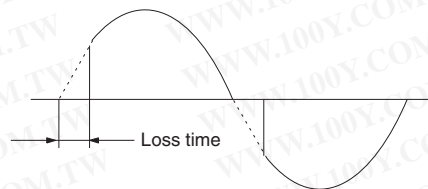

Fuses

Connect quick-break fuse in series with the load as a short-circuit protection measure. Use one of the fuses in the following table or one with equivalent or better characteristics.

Recommended Fuses

G3NB rated load current	Applicable SSR	FUSE (IEC60269-4)
5 A	G3NB-205B-1	10 A
10 A	G3NB-210B-1	32 A
20 A	G3NB-220B-1	
25 A	G3NB-225B-1	63 A
40 A	G3NB-240B-1	
75 A	G3NB-275B-1	100 A
90 A	G3NB-290B-1	

Leakage Current

A leakage current flows through a snubber circuit in the G3NB even when there is no power input. Therefore, always turn OFF the power to the input or load and check that it is safe before replacing or wiring the G3NB.

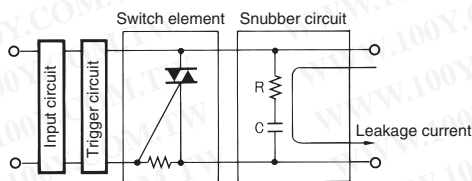

High-capacity Heat Sink (Y92B-P250NF)

DIN-track Mounting

- Assembled DIN Tracks are heavy. Mount the DIN Tracks securely. Be sure that the Heat Sink is securely locked to the DIN Track.
- Attach End Plates (PFP-M, order separately) to both ends of the Units on the DIN Track to hold them in place.
- To mount a Heat Sink to a DIN Track, press down at the point indicated by arrow 1 in the diagram and then press in the Heat Sink at the point indicated by arrow 2.

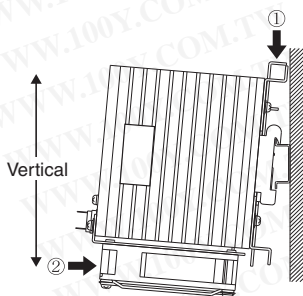

Applicable DIN Track

Mounting is possible on TE35-15Fe (IEC 60715) DIN tracks. DIN tracks from the following manufacturers can be used.

Manufacturer	Thickness: 1.5 mm	Thickness: 2.3 mm
Schneider	AM1-DE200	---
WAGO	210-114 or 210-197	210-118
PHOENIX	NS35/15	NS35/15/15-2.3

Direct Mounting

- Prepare mounting holes as shown in the diagram. Tightening torque: 0.98 to 1.47 N·m

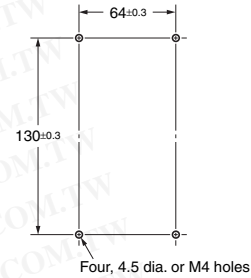

- When mounting a Heat Sink directly, first remove the Fan Unit, then mount the Heat Sink by itself before attaching the Fan Unit again. (Remove the two screws shown in the following diagram.)

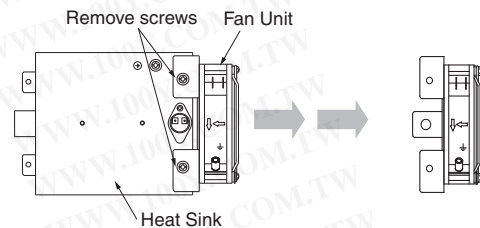

- First, temporarily mount the Heat Sink with the bottom two screws and then attach the top two screws with the mounting bracket sandwiched between the Heat Sink and mounting surface. Finally, tighten all four screws.

Ratings and Characteristics of High-capacity Heat Sink (Y92B-P250NF)

Fan Ratings

Rated voltage	200 V
Operating voltage	85% to 110% of rated voltage
Frequency	50/60 Hz
Rated current (See note.)	0.061 A at 50 Hz 0.052 A at 60 Hz
Rated speed (See note.)	2,600 r/min at 50 Hz 3,050 r/min at 60 Hz

Note: Average values.

Thermostat Ratings

Operating temperature	Approx. 90°C
Contact ratings	8 A at 250 VAC, resistive load 5 A at 30 VDC, resistive load

Fan Characteristics

Motor type	Single-phase shading coil induction motor (2-pole, open type)
Terminal type	Terminals
Insulation class	IEC class B (130°C) UL class A (105°C) CSA class A (105°C)
Insulation resistance	100 MΩ min. (at 500 VDC) between all power supply connections and uncharged metal parts.
Insulation withstand voltage	2,000 VAC (1 minute) between all power supply connections and uncharged metal parts.
Ambient operating temperature	-30 to 70°C (no icing)
Ambient storage temperature	-40 to 85°C (no icing)
Ambient humidity	25 to 85%
Protection	Impedance protection
Materials	Frame : Die-cast aluminum Blades : Glass polycarbonate
Bearings	Ball bearings
Weight	Approx. 300 g
Compliant standards	PSE, EN/IEC 60335 (CE marking compliant)
Certified standards	UL/CSA

- Use a commercial power supply (50/60 Hz) for the Fan.
- Be sure to turn OFF the power supply and wait for the blades to stop before inspecting the Fan.
- High-precision ball bearings are used in the fan and these may be damaged if the Fan is dropped or otherwise subjected to shock. The life and characteristics of the Fan will be reduced if the bearings are damaged. Do not subject the Fan to shock.
- The life of the Fan depends on the ambient temperature. As a guideline, the Fan life is 40,000 hours for continuous usage at 40°C.
- Be sure there are no objects near the air vents that would restrict air flow and no loose objects, such as electrical lines.
- The Fan is an OMRON R87F-A4A-93HP (200 VAC) Fan. Use the same model of Fan for replacement.
- The recommended tightening torque for the Fan is 0.44 N·m.
- Terminals equivalent to Faston #110 are used for the Fan power supply terminals.
- Refer to the following table for the OMRON Fan power supply plug cables (order separately).

Cable length	UL certified	Complies with Electrical Appliance and Material Safety Law (Japan)
1 m	R87F-PC	R87F-PCJT
2 m	R87F-PC-20	R87F-PCJT-20

- Connect the ground screw hole on the fan to **PE**.

Preventing Overheating with a High-capacity Heat Sink (Y92B-P250NF)

- When the High-capacity Heat Sink is used, high-capacity switching at 75 A or 90 A requires forced cooling with a fan. Connect the Fan to a power supply according to its ratings specifications.
- If the Fan stops due to a power supply error, due to foreign matter in the power supply connection, or due to aging, the Heat Sink will heat to high temperatures, possibly resulting in failure of the SSR or adverse affects on other devices. Implement an overheating prevention measure, such as turning OFF the load current, if the Heat Sink overheats.
- A thermostat is provided to detect overheating. The thermostat uses a NC contact, i.e., the circuit will be opened for overheating. This thermostat can be used to stop the operation of the SSR. Implement an overheating prevention measure by using this signal to output an alarm or perform another response applicable to the system. Also, confirm that there is no problem with the overall system.
- Do not connect the thermostat directly to the load power supply. Connect it to a contactor or other shutoff device connected above the SSR.
- Terminals equivalent to Faston #187 are used for the thermostat terminals.
- Do not place heat-dissipating silicon grease on the thermostat.
- Do not solder the thermostat terminals.
- The following diagram shows a protective circuit example.

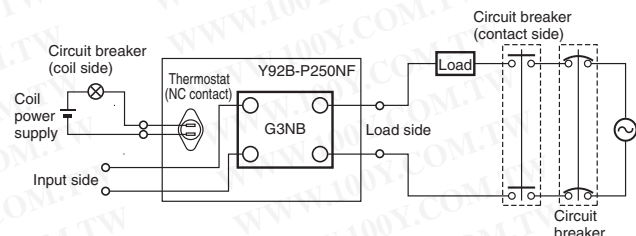

Ventilating a High-capacity Heat Sink (Y92B-P250NF)

- Refer to *Ventilation Outside the Control Panel*.

Operating Conditions

- Do not apply currents exceeding the rated current otherwise, the temperature of the G3NB may rise excessively.
- As protection against accidents due to short-circuiting, be sure to install protective devices, such as fuses and no-fuse breakers, on the power supply side.
- Do not apply overvoltages to the input circuit or output circuit. Failure or burning may result.
- Do not drop the G3NB or otherwise subject it to abnormal shock. Malfunction or failure may result.
- Keep the cooling system running continuously during the ON/OFF operation of the SSR. This is to allow residual heat to dissipate while the SSR is OFF. (load current 75 A, 90 A models)
- The Y92B-P250NF is a Class 1 device. If compliance with EU standards is required, ground the Y92B-P250NF.
- Use the ground terminal on the Heat Sink. Screw size: M5 Tightening torque: 2 N·m Do not use the ground terminal on the fan.

勝特力材料 886-3-5753170
勝特力电子(上海) 86-21-34970699
勝特力电子(深圳) 86-755-83298787
Http://www.100y.com.tw

Read and Understand this Catalog

Please read and understand this catalog before purchasing the product. Please consult your OMRON representative if you have any questions or comments.

Warranty and Limitations of Liability

WARRANTY

OMRON's exclusive warranty is that the products are free from defects in materials and workmanship for a period of one year (or other period if specified) from date of sale by OMRON.

OMRON MAKES NO WARRANTY OR REPRESENTATION, EXPRESS OR IMPLIED, REGARDING NON-INFRINGEMENT, MERCHANTABILITY, OR FITNESS FOR PARTICULAR PURPOSE OF THE PRODUCTS. ANY BUYER OR USER ACKNOWLEDGES THAT THE BUYER OR USER ALONE HAS DETERMINED THAT THE PRODUCTS WILL SUITABLY MEET THE REQUIREMENTS OF THEIR INTENDED USE. OMRON DISCLAIMS ALL OTHER WARRANTIES, EXPRESS OR IMPLIED.

LIMITATIONS OF LIABILITY

OMRON SHALL NOT BE RESPONSIBLE FOR SPECIAL, INDIRECT, OR CONSEQUENTIAL DAMAGES, LOSS OF PROFITS OR COMMERCIAL LOSS IN ANY WAY CONNECTED WITH THE PRODUCTS, WHETHER SUCH CLAIM IS BASED ON CONTRACT, WARRANTY, NEGLIGENCE, OR STRICT LIABILITY.

In no event shall the responsibility of OMRON for any act exceed the individual price of the product on which liability is asserted.

IN NO EVENT SHALL OMRON BE RESPONSIBLE FOR WARRANTY, REPAIR, OR OTHER CLAIMS REGARDING THE PRODUCTS UNLESS OMRON'S ANALYSIS CONFIRMS THAT THE PRODUCTS WERE PROPERLY HANDLED, STORED, INSTALLED, AND MAINTAINED AND NOT SUBJECT TO CONTAMINATION, ABUSE, MISUSE, OR INAPPROPRIATE MODIFICATION OR REPAIR.

Application Considerations

SUITABILITY FOR USE

OMRON shall not be responsible for conformity with any standards, codes, or regulations that apply to the combination of the product in the customer's application or use of the product.

Take all necessary steps to determine the suitability of the product for the systems, machines, and equipment with which it will be used.

Know and observe all prohibitions of use applicable to this product.

NEVER USE THE PRODUCT FOR AN APPLICATION INVOLVING SERIOUS RISK TO LIFE OR PROPERTY WITHOUT ENSURING THAT THE SYSTEM AS A WHOLE HAS BEEN DESIGNED TO ADDRESS THE RISKS, AND THAT THE OMRON PRODUCT IS PROPERLY RATED AND INSTALLED FOR THE INTENDED USE WITHIN THE OVERALL EQUIPMENT OR SYSTEM.

PROGRAMMABLE PRODUCTS

OMRON shall not be responsible for the user's programming of a programmable product, or any consequence thereof.

Disclaimers

CHANGE IN SPECIFICATIONS

Product specifications and accessories may be changed at any time based on improvements and other reasons. Consult with your OMRON representative at any time to confirm actual specifications of purchased product.

DIMENSIONS AND WEIGHTS

Dimensions and weights are nominal and are not to be used for manufacturing purposes, even when tolerances are shown.

PERFORMANCE DATA

Performance data given in this catalog is provided as a guide for the user in determining suitability and does not constitute a warranty. It may represent the result of OMRON's test conditions, and the users must correlate it to actual application requirements. Actual performance is subject to the OMRON Warranty and Limitations of Liability.