



1000 ~ 3000W Front End Power System

RCP series



■ Features :

- Universal AC input / Full range
- Built-in 5V/0.3A auxiliary power
- Built-in active PFC function, PF>0.96
- Protections: Short circuit / Overload / Over voltage / Over temperature
- Forced air cooling by built-in DC fan with fan speed control
- Low profile:1U height
- Active current sharing up to 3000W (3 units)in 19" rack, 3 racks max. can be operated in parallel (up to 8 units) (Note.7)
- Remote control for single unit
- Built-in remote sense function
- Output voltage trimming function
- Hot-swap operation
- Optional I²C serial data bus
- AC OK & DC OK signal
- Internal ORing diode
- 3 years warranty



■ SELECTION GUIDE

Single Unit: RCP-1000-**12**-**C**
 Rack: RCP-1U **I**
 Whole System: RCP-3K1U **I**-**12**-**C**

C: With I²C Interface
-: Without I²C Interface
Output Voltage
I: AC Inlet(IEC320-C14)
T: Terminal Block

C: With I²C Interface
-: Without I²C Interface
Output Voltage
I: AC Inlet(IEC320-C14)
T: Terminal Block

SPECIFICATION - Single Unit

MODEL		RCP-1000-12	RCP-1000-24	RCP-1000-48	
OUTPUT	DC VOLTAGE	12V	24V	48V	
	RATED CURRENT	60A	40A	21A	
	CURRENT RANGE	0 ~ 60A	0 ~ 40A	0 ~ 21A	
	RATED POWER	720W	960W	1008W	
	RIPPLE & NOISE (max.) Note.2	150mVp-p	200mVp-p	300mVp-p	
	VOLTAGE ADJ. RANGE	11.6 ~ 12.4V	23.2 ~ 24.8V	46.3 ~ 49.7V	
	VOLTAGE TOLERANCE Note.3	±1.0%	±1.0%	±1.0%	
	LINE REGULATION	±0.5%	±0.5%	±0.5%	
	LOAD REGULATION	±0.5%	±0.5%	±0.5%	
	SETUP, RISE TIME	1000ms, 60ms/230VAC at full load			
HOLD UP TIME (Typ.)	16ms/230VAC at full load				
INPUT	VOLTAGE RANGE Note.5	90 ~ 264VAC	127 ~ 370VDC		
	FREQUENCY RANGE	47 ~ 63Hz			
	EFFICIENCY (Typ.)	81%	87%	89%	
	AC CURRENT (Typ.)	8.5A/115VAC	4.5A/230VAC	10.5A/115VAC	5.5A/230VAC
	INRUSH CURRENT (Typ.)	COLD START 50A			
LEAKAGE CURRENT	<1.1mA / 230VAC				
PROTECTION	OVERLOAD	105 ~ 125% rated output power Protection type : Constant current limiting, recovers automatically after fault condition is removed			
	OVER VOLTAGE	13.2 ~ 16.2V	26.4 ~ 32.4V	52.8 ~ 64.8V	
		Protection type : Shut down o/p voltage, re-power on to recover			
	OVER TEMPERATURE	75°C ±5°C (TSW1) detect on heatsink of power transistor 85°C ±5°C (TSW2) detect on heatsink of power diode Protection type : Shut down o/p voltage, recovers automatically after temperature goes down			



1000 ~ 3000W Front End Power System

RCP series

MODEL		RCP-1000-12	RCP-1000-24	RCP-1000-48
FUNCTION	AUXILIARY POWER	5V @ 0.3A		
	REMOTE ON/OFF CONTROL	By electrical signal or dry contact ON:short OFF:open		
	REMOTE SENSE	Compensate voltage drop on the load wiring up to 0.5V		
	DC OK SIGNAL	Open collector signal, on when Vout ≥ 80%±5%, max. sink current:10mA		
	AC FAIL SIGNAL	Open collector signal, refer to function manual		
	OUTPUT VOLTAGE TRIM	Adjustment of output voltage, possible between 90 ~ 110% of rated output		
ENVIRONMENT	OVER TEMP WARNING	Logic " High" for over temperature warning, refer to function manual		
	WORKING TEMP.	-20 ~ +60°C (Refer to output load derating curve)		
	WORKING HUMIDITY	20 ~ 90% RH non-condensing		
	STORAGE TEMP., HUMIDITY	-40 ~ +85°C, 10 ~ 95% RH		
	TEMP. COEFFICIENT	±0.02%/°C (0 ~ 50°C)		
SAFETY & EMC (Note 4)	VIBRATION	10 ~ 500Hz, 2G 10min./1cycle, 60min. each along X, Y, Z axes		
	SAFETY STANDARDS	UL60950-1, TUV EN60950-1 approved		
	WITHSTAND VOLTAGE	I/P-O/P:3KVAC I/P-FG:1.5KVAC O/P-FG:0.7KVDC		
	ISOLATION RESISTANCE	I/P-O/P, I/P-FG, O/P-FG:100M Ohms/500VDC		
	EMI CONDUCTION & RADIATION	Compliance to EN55022 (CISPR22) Class B		
	HARMONIC CURRENT	Compliance to EN61000-3-2,-3		
OTHERS	EMS IMMUNITY	Compliance to EN61000-4-2,3,4,5,6,8,11, ENV50204, EN61000-6-2 (EN50082-2), heavy industry level, criteria A		
	MTBF	43.4Khrs min. MIL-HDBK-217F (25°C)		
	DIMENSION	295*127*41mm (L*W*H)		
	PACKING	1.91Kg; 6pcs/12.5Kg/1.04CUFT		

勝特力材料 886-3-5753170
勝特力电子(上海) 86-21-34970699
勝特力电子(深圳) 86-755-83298787
[Http://www.100y.com.tw](http://www.100y.com.tw)

SPECIFICATION - Rack System

MODEL		RCP-3K1U□-12	RCP-3K1U□-24	RCP-3K1U□-48
OUTPUT	MODULE	RCP-1000-12	RCP-1000-24	RCP-1000-48
	RACK	RCP-1U1 or RCP-1UT		
	OUTPUT VOLTAGE	12V	24V	48V
	MAX. OUTPUT CURRENT	180A	120A	63A
	MAX. OUTPUT POWER <small>Note.6</small>	2160W	2880W	3024W
INPUT	VOLTAGE RANGE <small>Note.5</small>	90 ~ 264VAC 127 ~ 370VDC		
	FREQUENCY RANGE	47 ~ 63Hz		
	AC CURRENT (Typ.)FOR EACH UNIT	8.5A/115VAC 4.5A/230VAC	10.5A/115VAC 5.5A/230VAC	11A/115VAC 5.5A/230VAC
	LEAKAGE CURRENT	<3.5mA / 230VAC		
FUNCTION	AUXILIARY POWER	5V @ 0.3A		
	REMOTE ON/OFF CONTROL	By electrical signal or dry contact ON:short OFF:open		
	REMOTE SENSE	Compensate voltage drop on the load wiring up to 0.5V. "Local Sense"should be connected in order to get the correct output voltage if the "Remote Sense" is not used		
	DC OK SIGNAL	The TTL signal out, refer to function manual		
	AC FAIL SIGNAL	The TTL signal out, refer to function manual		
	OUTPUT VOLTAGE TRIM	Adjustment of output voltage, possible between 90 ~ 110% of rated output		
	OVER TEMP WARNING	Logic " High" for over temperature warning, refer to function manual		
ENVIRONMENT	WORKING TEMP.	-20 ~ +60°C (Refer to output load derating curve)		
	WORKING HUMIDITY	20 ~ 90% RH non-condensing		
	STORAGE TEMP., HUMIDITY	-40 ~ +85°C, 10 ~ 95% RH		
	TEMP. COEFFICIENT	±0.02%/°C (0 ~ 50°C)		
	VIBRATION	10 ~ 500Hz, 2G 10min./1cycle, 60min. each along X, Y, Z axes		
SAFETY & EMC (Note 4)	SAFETY STANDARDS	UL60950-1, TUV EN60950-1 approved		
	WITHSTAND VOLTAGE	I/P-O/P:3KVAC I/P-FG:1.5KVAC O/P-FG:0.7KVDC		
	ISOLATION RESISTANCE	I/P-O/P, I/P-FG, O/P-FG:100M Ohms/500VDC		
	EMI CONDUCTION & RADIATION	Compliance to EN55022 (CISPR22) Class B		
	HARMONIC CURRENT	Compliance to EN61000-3-2,-3		
OTHERS	EMS IMMUNITY	Compliance to EN61000-4-2,3,4,5,6,8,11, ENV50204, EN61000-6-2 (EN50082-2), heavy industry level, criteria A		
	DIMENSION	Rack 483.6*350.8*44(L*W*H)		
	PACKING	11Kg; 1pcs/11Kg/2.67CUFT		
NOTE	<ol style="list-style-type: none"> All parameters NOT specially mentioned are measured at 230VAC input, rated load and 25°C of ambient temperature. Ripple & noise are measured at 20MHz of bandwidth by using a 12" twisted pair-wire terminated with a 0.1uf & 47uf parallel capacitor. Tolerance : includes set up tolerance, line regulation and load regulation. The power supply is considered a component which will be installed into a final equipment. The final equipment must be re-confirmed that it still meets EMC directives. Derating may be needed under low input voltages. Please check the derating curve for more details. Output of all the RCP-1000 modules are connected in parallel in the rack. Under parallel operation of more than one rack connecting together, ripple of the output voltage may be higher than the SPEC at light load condition. It will go back to normal ripple level once the output load is more than 10%. 			



■ Mechanical Specification (Single Unit)

Case No. 952A Unit:mm

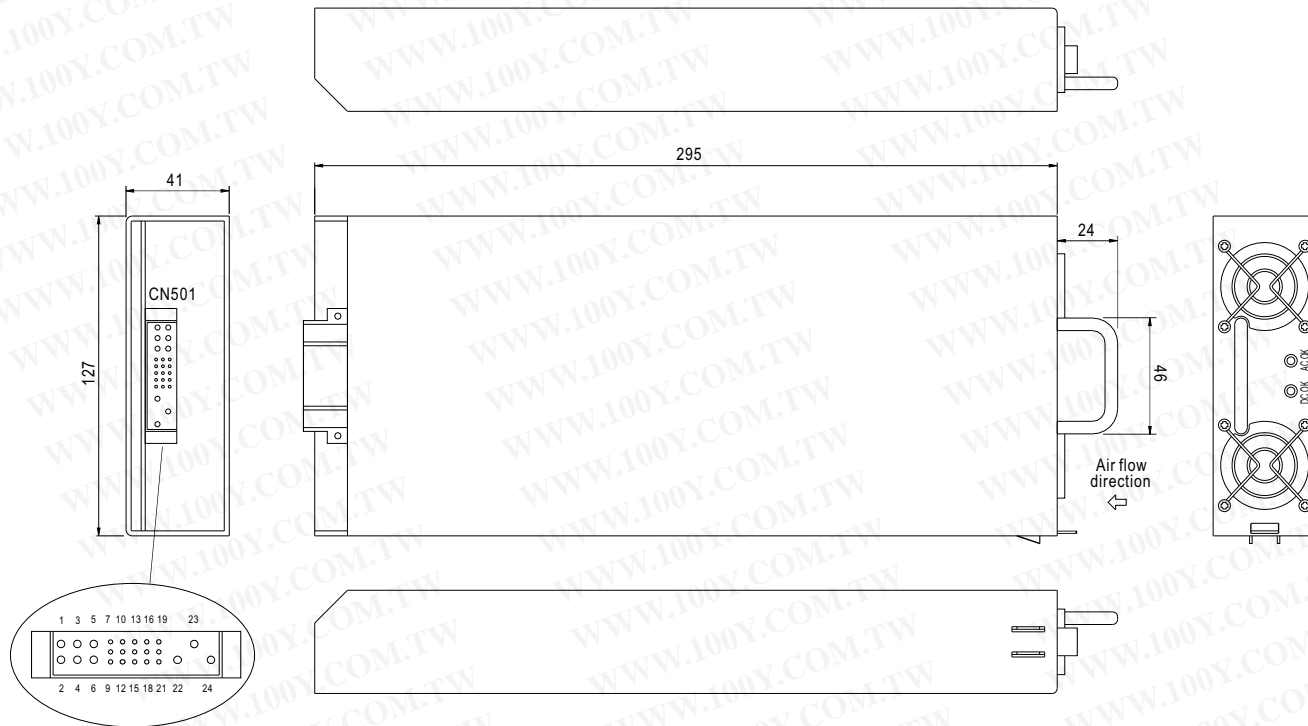

Input / Output Connector Pin No. Assignment(CN501) : Postronic PCB24W9M400A1

Pin No.	Assignment	Pin No.	Assignment	Pin No.	Assignment	Pin No.	Assignment	Mating Housing
1,2,4	+V	10	AC_OK	15	+5V_AUX	20	A1	Postronic PCB24W9F400A1
3,5,6	-V	11	DC_OK	16	GND_AUX	21	A2	
7	ON/OFF	12	CS	17	SDA	22	FG	
8	+S	13	V_TRIM	18	SCL	23	AC/L	
9	-S	14	T_ALARM	19	A0	24	AC/N	

■ Block Diagram

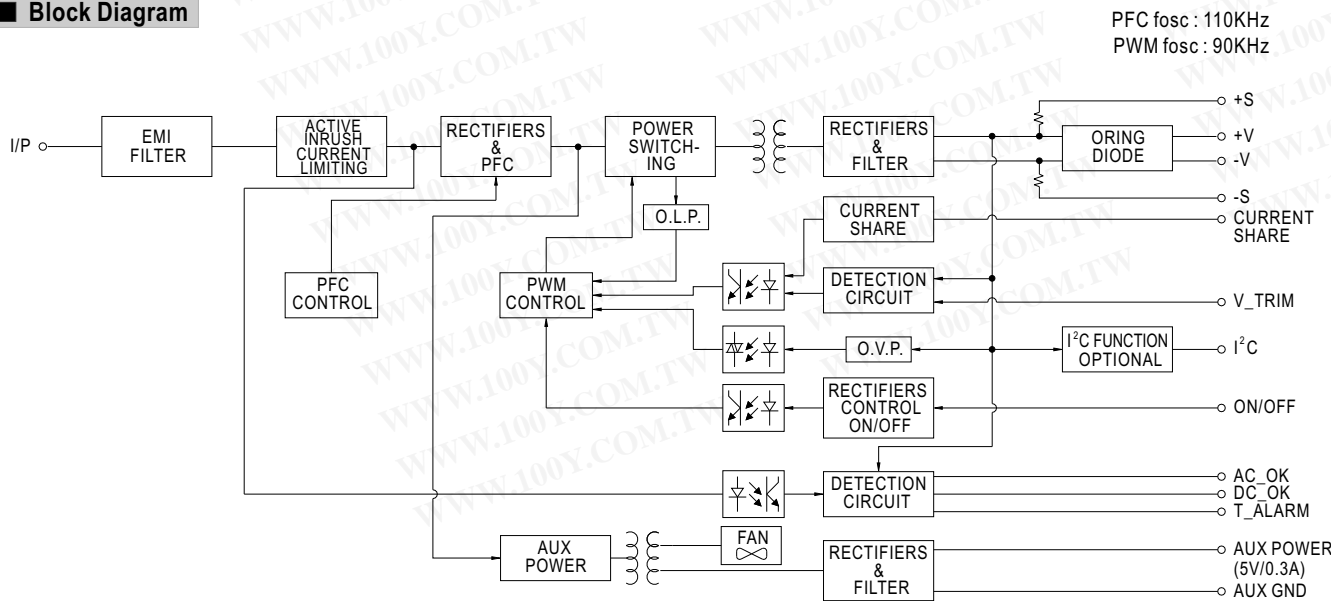



1000 ~ 3000W Front End Power System

RCP series

■ Mechanical Specification (Rack System)

Case No. 959A Unit:mm

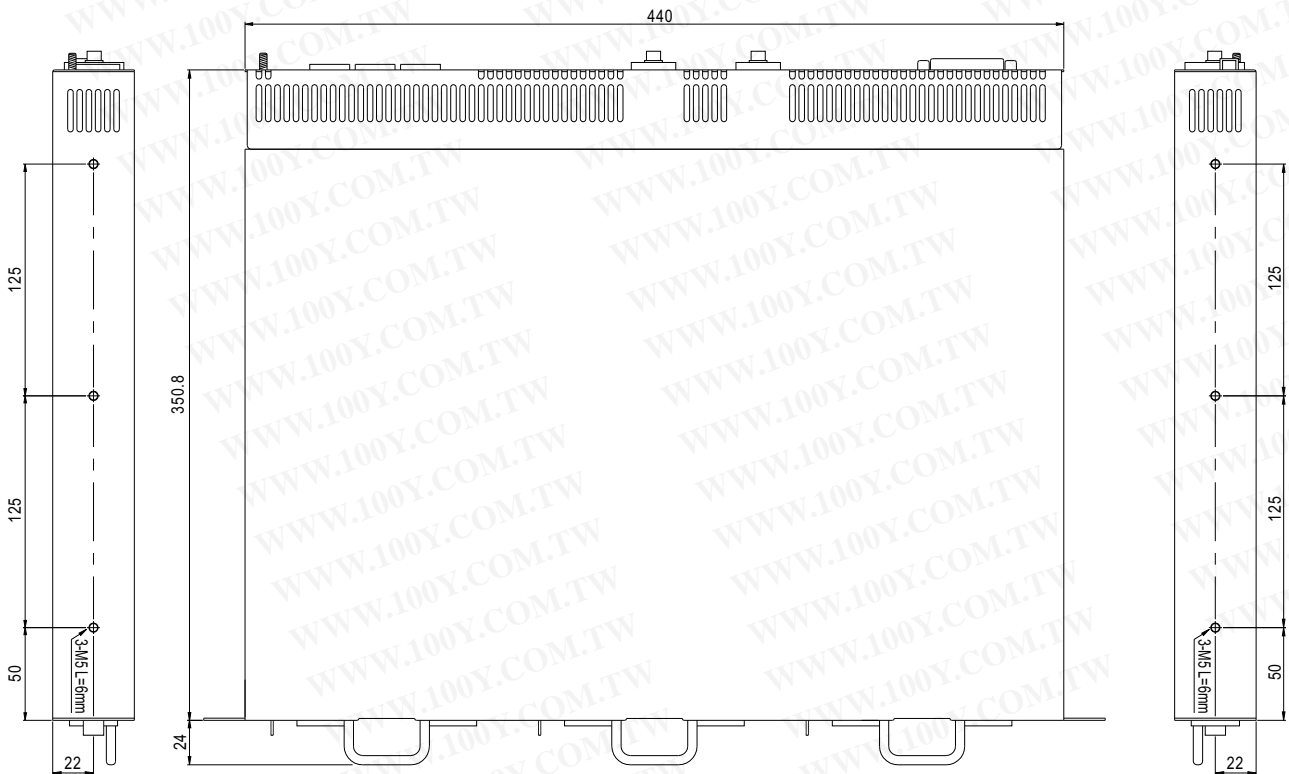
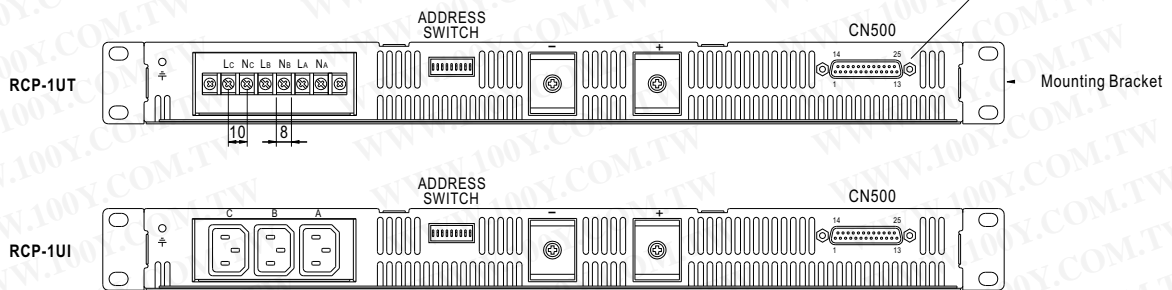
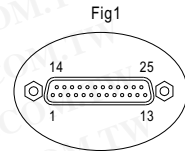
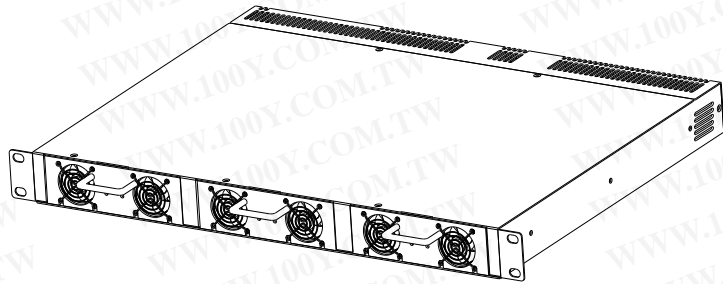

↑ Air flow direction

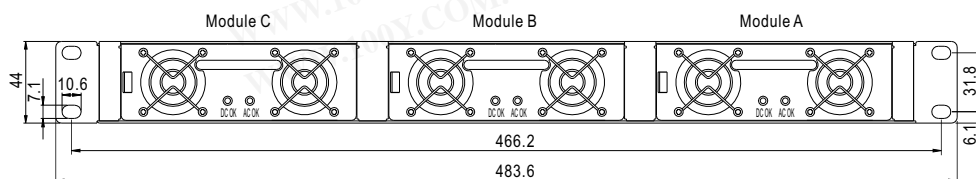

■ CN500 Pin No. Assignment

Connector Pin No. Assignment(CN500) : D-Type Right Angle 25 positions

Pin No.	Assignment	Pin No.	Assignment	Pin No.	Assignment	Pin No.	Assignment	Pin No.	Assignment
1	ON/OFF-A	6	+5V-AUX	11	V-TRIM-B	16	AC-OK-C	21	-S
2	AC-OK-A	7	GND-AUX	12	T-ALARM-B	17	DC-OK-C	22	+V
3	DC-OK-A	8	ON/OFF-B	13	NC	18	V-TRIM-C	23	SCL
4	V-TRIM-A	9	AC-OK-B	14	CS	19	T-ALARM-C	24	SDA
5	T-ALARM-A	10	DC-OK-B	15	ON/OFF-C	20	+S	25	-V

■ CN500 IN/OUT Connector pins function description

Pin No.	Function	Description
1, 8, 15	ON/OFF	Each unit can separately turn the output on and off by electrical or dry contact between ON/OFF A,B,C(pin 1,8,15) and -S(pin 21). Short: ON, Open:OFF.
2, 9, 16	AC-OK	Low : When the input voltage is $\geq 82V_{rms} \pm 4V$. High : when the input voltage in $\leq 82V_{rms} \pm 4V$.
3, 10, 17	DC-OK	High : When the $V_{out} \leq 80\% \pm 5\%$. Low : When $V_{out} \geq 80\% \pm 5\%$
4, 11, 18	V-TRIM	Connection for output voltage trimming. The voltage can be trimmed within its defined range.
5, 12, 19	T-ALARM	High : When the internal temperature is within safe limit. Low : $10^{\circ}C$ below the thermal shut down limit.
6	+5V-AUX	Auxiliary voltage output, 4.3~5.3V, referenced to GND-AUX(pin 7). The maximum load current is 0.3A. This output has the built-in "Oring diodes" and is not controlled by the remote ON/OFF control.
7	GND-AUX	Auxiliary voltage output GND. The signal return is isolated from the output terminals (+V & -V).
14	CS	Current sharing signal. When units are connected in parallel, the CS pins of the units should be connected to allow current balance between units.
20	+S	Positive sensing. The +S signal should be connected to the positive terminal of the load. The +S and -S leads should be twisted in pair to minimize noise pick-up effect. The maximum line drop compensation is 0.5V.
21	-S	Negative sensing. The -S signal should be connected to the negative terminal of the load. The -S and +S leads should be twisted in pair to minimize noise pick-up effect. The maximum line drop compensation is 0.5V.
22	+V	Positive output voltage. For local sense use only, can't be connected directly to the load.
23	SCL	Serial clock used in the I ² C interface option. Refer to the I ² C interface description.
24	SDA	Serial data used in the I ² C interface option. Refer to the I ² C interface description.
25	-V	Negative output voltage. For local sense use only, can't be connected directly to the load.

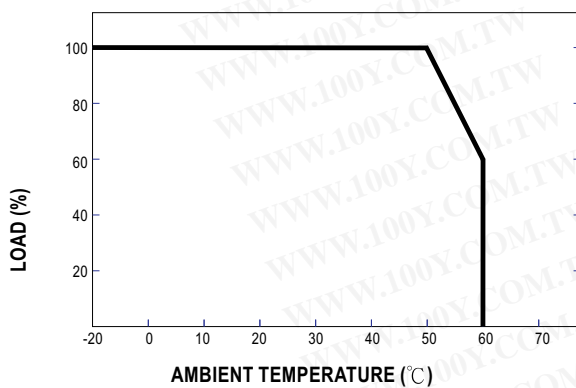
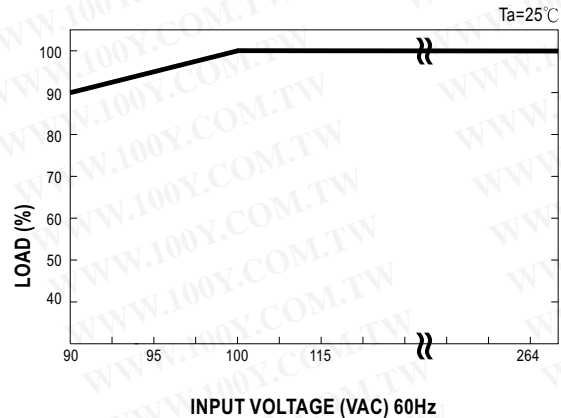
■ Derating Curve

■ Static Characteristics

勝特力材料 886-3-5753170
 勝特力电子(上海) 86-21-34970699
 勝特力电子(深圳) 86-755-83298787
[Http://www.100y.com.tw](http://www.100y.com.tw)

■ Function Manual

1. Remote ON/OFF Control

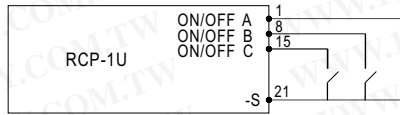
The PSU can be turned ON/OFF together or separately by using the "Remote ON/OFF" function.



Between ON/OFF and -S	Output
SW Open	OFF
SW Short	ON

2. Voltage Drop Compensation

2.1 Remote Sense

The remote sense compensates voltage drop on the load wiring up to 0.5V.

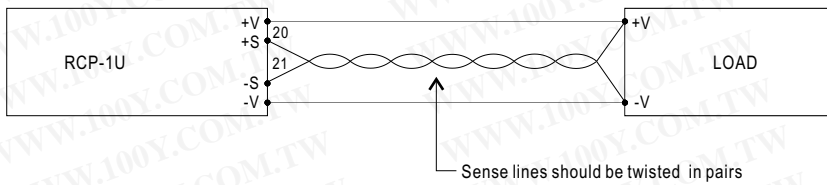

2.2 Local Sense

Notice : The +S,-S have to be connected to the +V,-V terminals locally in order to get the correct output voltage if the remote sensing is not used.



3. Output Voltage Trimming

Output voltage can be trimmed between 90~110% of its rated value by the following method.

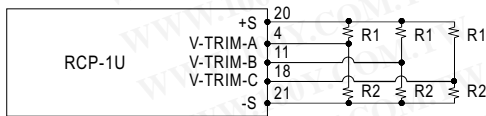

3.1 RCP-1000-12

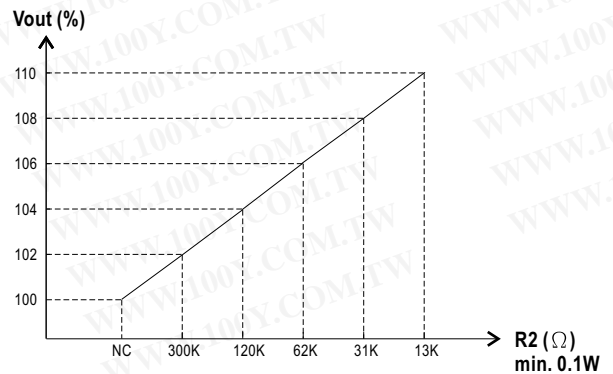
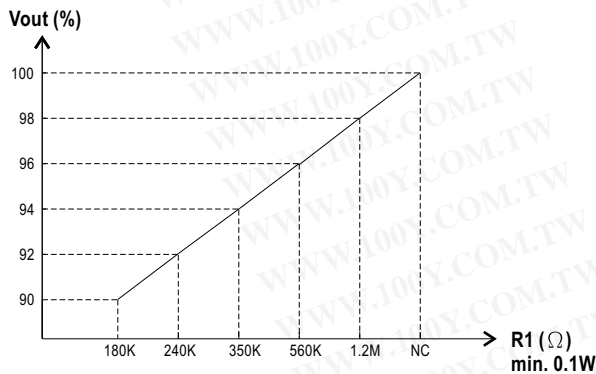

勝特力材料 886-3-5753170
 勝特力电子(上海) 86-21-34970699
 勝特力电子(深圳) 86-755-83298787
[Http://www.100y.com.tw](http://www.100y.com.tw)

3.2 RCP-1000-24

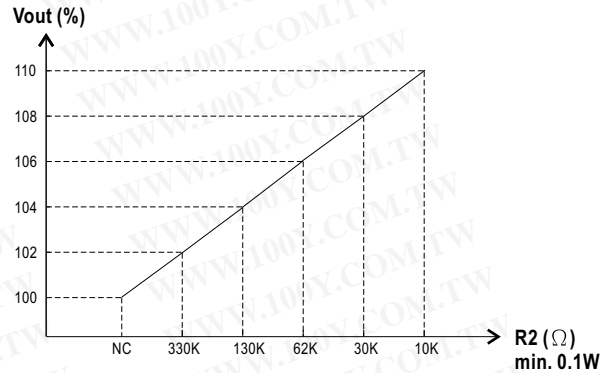
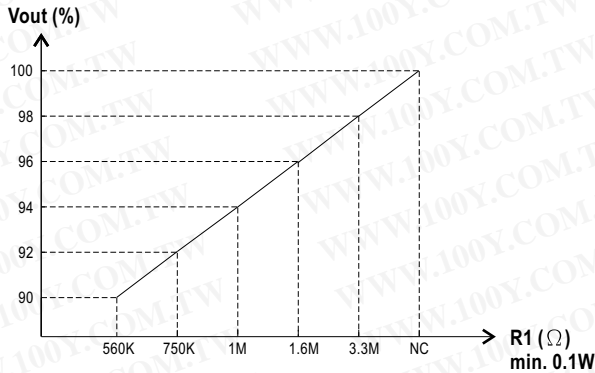

3.3 RCP-1000-48

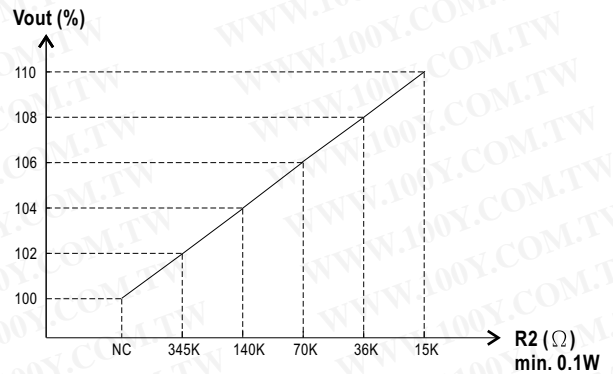
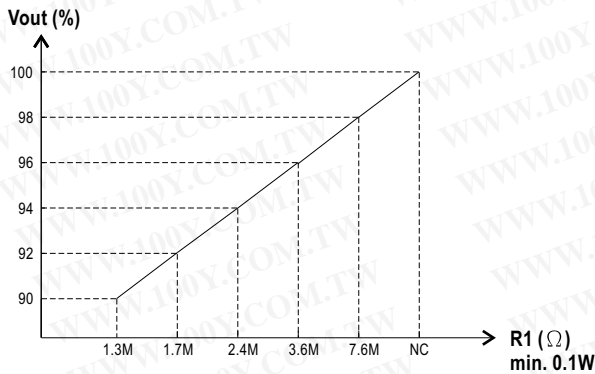

4. Front Panel Indicators & Corresponding Signal at Function Pins

Function	LED	Description	* Signal	PSU Output
AC-OK	ON	When input voltage $\geq 82V \pm 4V$	0 ~ 0.5V	ON
AC-NG	OFF	When input voltage $\leq 82V \pm 4V$	4.5 ~ 5.5V	OFF
DC-OK	ON	When output voltage $\geq 80\% \pm 5\%$ of Vo rated.	0 ~ 0.5V	ON
DC-NG	OFF	When output voltage $\leq 80\% \pm 5\%$ of Vo rated.	4.5 ~ 5.5V	ON
T-OK	----	When the internal temperature (TSW1 & TSW2 short) is within safe limit	0 ~ 0.5V	ON
T-ALARM	----	When the internal temperature (TSW1 or TSW2 open) exceeds the limit of temperature alarm	4.5 ~ 5.5V	OFF

*Signal between function pin and "-S".

5. I²C Bus Interface Option

5.1 Addressing(A0,A1,A2)

The DIP switch down position is logic level "1" and the up position is level "0". Address are applicable when modules RCP-1000 I²C function are used.

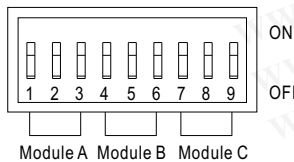

Address dip switch setting

A2	A1	A0	Module
3	2	1	A
6	5	4	B
9	8	7	C

勝特力材料 886-3-5753170
 勝特力电子(上海) 86-21-34970699
 勝特力电子(深圳) 86-755-83298787
[Http://www.100y.com.tw](http://www.100y.com.tw)

5.2 Digital Function (Read Only)

Digital function are provided by a PCF8574 8-bit I/O port device. When this device is read by the I²C bus controller, a single 8-bit word provides the following information.

BIT	FUNCTION	GOOD STATE	FAIL STATE	MEANING
0	AC Input Fail	0	1	Input power fail
1	Output Power Good / Fail	0	1	Output voltage is less than specification
2	Temperature Warning	0	1	Internal temperature is over 60°C. PSU turns on
3	Over Temperature Protection	0	1	Temperature exceeds nominal operating limit. PSU turns off
4	Fan Fail Warning	0	1	Failure of an internal fan
5	Not Used	-----	-----	Not used
6	Not Used	-----	-----	Not used
7	Not Used	-----	-----	Not used

PCF8574 slave address

Bit	7	6	5	4	3	2	1	0
Value	0	1	0	0	A2	A1	A0	R/W

Read : 1
Write : 0

6. Analog Function (Read Only)

6.1 Analog function are provided by a single PCF8591 4-channel 8-bit A/D converter. When this device is read by the I²C bus controller, it provides an 8-bit word with the following information:

A/D Channel	FUNCTION
1	Output Voltage
2	Output Current
3	Internal Temperature
4	Not Used

PCF8591 slave address

Bit	7	6	5	4	3	2	1	0
Value	1	0	0	1	A2	A1	A0	R/W

PCF8591 control byte

Bit	7	6	5	4	3	2	1	0
Value	0	0	0	0	0	0		

0 0 : Output Voltage
0 1 : Output Current
1 0 : Internal Temperature

6.2 A/D scaling

The voltage reading is made inside the power supply unit before the "Oring diode" and is typically 0.5V higher than the actual output voltage.

The following table for the scaling should be employed:

VALUE = BYTE VALUE x RESOLUTION

Output Voltage	Range	Scaling	Tolerance	
12V	0~16V	0.0625V/Bit	±5%	A/D Channel 1 Voltage
24V	0~33V	0.129V/Bit	+3%,-5%	
48V	0~65V	0.254V/Bit	+2%,-5%	
12V	0~80A	0.312A/Bit	±10%	A/D Channel 2 Current
24V	0~55A	0.215A/Bit	±10%	
48V	0~30A	0.117A/Bit	±10%	
12V	0~100°C	0.391°C/Bit	±3°C	A/D Channel 3 Temperature
24V	0~100°C	0.391°C/Bit	±3°C	
48V	0~100°C	0.391°C/Bit	±3°C	

7.EEPROM Function (Read Only)

The EEPROM is a 2048 bit (256 byte) device which is preprogrammed at the factory with the following data :

Address	Bytes	Data
4	16	Manufacturer
20	20	Serial Number
40	16	Revision
56	16	Country of production
72	16	Model Name
88	16	Output Voltage
104	16	Date of production
254	2	Check Sum

EEPROM slave address

Bit	7	6	5	4	3	2	1	0
Value	1	0	1	0	A2	A1	A0	R/W

勝特力材料 886-3-5753170
勝特力电子(上海) 86-21-34970699
勝特力电子(深圳) 86-755-83298787
Http://www.100y.com.tw