



### 30W Single Output Switching Power Supply

# ELN-30 series



#### ■ Features :

- Universal AC input / Full range
- Fully isolated plastic case with IP64 level
- Built-in constant current limiting circuit with adjustable OCP level
- Protections: Short circuit / Overload / Over voltage
- Optional dimming function : 1.1~10VDC (D type) or PWM (P type) controlled
- UL1310 Class 2 power unit
- Cooling by free air convection
- 100% full load burn-in test
- Suitable for LED lighting and moving sign applications
- Low cost
- 2 years warranty

#### SPECIFICATION

IP64 CE

MODEL	ELN-30-5	ELN-30-9	ELN-30-12	ELN-30-15	ELN-30-24	ELN-30-27	ELN-30-48	
OUTPUT	DC VOLTAGE	5V	9V	12V	15V	24V	27V	48V
	LED OPERATION VOLTAGE Note.7	3 ~ 5V	3 ~ 9V	3 ~ 12V	3 ~ 15V	3 ~ 24V	3 ~ 27V	3 ~ 48V
	RATED CURRENT	5A	3.4A	2.5A	2A	1.25A	1.12A	0.63A
	CURRENT RANGE	0 ~ 5A	0 ~ 3.4A	0 ~ 2.5A	0 ~ 2A	0 ~ 1.25A	0 ~ 1.12A	0 ~ 0.63A
	RATED POWER	25W	30.6W	30W	30W	30W	30.24W	30.24W
	RIPPLE & NOISE (max.) Note.2	80mVp-p	100mVp-p	120mVp-p	120mVp-p	150mVp-p	150mVp-p	250mVp-p
	VOLTAGE ADJ. RANGE	4.5 ~ 5.5V    8.7 ~ 10.5V    10.8 ~ 13.2V    13.5 ~ 16.5V    21.6 ~ 26.4V    24.3 ~ 29.7V    43.2 ~ 52.8V						
	CURRENT ADJ. RANGE	-25% ~ 3%. Can be adjusted by internal potential meter SVR2						
	VOLTAGE TOLERANCE Note.3	±5.0%						
	LINE REGULATION	±1.0%						
	LOAD REGULATION	±2.0%						
	INPUT	SETUP, RISE TIME Note.6	500ms, 80ms / 230VAC    1000ms, 80ms / 115VAC at full load					
HOLD UP TIME (Typ.)		50ms/230VAC    16ms/115VAC at full load						
VOLTAGE RANGE		90 ~ 264VAC						
FREQUENCY RANGE		47 ~ 63Hz						
EFFICIENCY (Typ.)		75%	80%	82%	82%	85%	85%	87%
PROTECTION	AC CURRENT	0.75A/115VAC    0.48A/230VAC						
	INRUSH CURRENT(max.)	COLD STAR 60A/230VAC						
	LEAKAGE CURRENT	0.25mA / 240VAC						
FUNCTION	OVER CURRENT Note.4	95 ~ 110% Protection type : Constant current limiting, recovers automatically after fault condition is removed						
	OVER VOLTAGE	5.75 ~ 6.75V	11 ~ 13.5V	13.8 ~ 16V	17.5 ~ 21V	28 ~ 32V	31 ~ 36.4V	54 ~ 60V
ENVIRONMENT	DIMMING CONTROL (OPTIONAL)	1 ~ 10VDC or PWM						
	WORKING TEMP.	-20 ~ +60°C (Refer to output load derating curve)						
	WORKING HUMIDITY	20 ~ 90% RH non-condensing						
	STORAGE TEMP., HUMIDITY	-40 ~ +80°C, 10 ~ 95% RH						
	TEMP. COEFFICIENT	±0.03%/°C (0 ~ 50°C)						
SAFETY & EMC	VIBRATION	10 ~ 500Hz, 2G 10min./1cycle, period for 60min. each along X, Y, Z axes						
	SAFETY STANDARDS	Design refer to UL1310 Class 2, TUV EN60950-1, CAN/CSA C22.2 No. 223-M91(except for 48V), EN61347-2-13; IP64 approved						
	WITHSTAND VOLTAGE	I/P-O/P:3KVAC						
	ISOLATION RESISTANCE	I/P-O/P:>100M Ohms / 500VDC / 25°C / 70% RH						
	EMI CONDUCTION & RADIATION	Compliance to EN55022 (CISPR22) Class B						
	HARMONIC CURRENT	Compliance to EN61000-3-2,-3						
OTHERS	EMS IMMUNITY	Compliance to EN61000-4-2,3,4,5,6,8,11; ENV50204, EN55024, light industry level, criteria A						
	MTBF	628.3Khrs min.    MIL-HDBK-217F (25°C)						
	DIMENSION	145*47*30mm (L*W*H)						
NOTE	PACKING							
<p>1. All parameters NOT specially mentioned are measured at 230VAC input, rated load and 25°C of ambient temperature.                  2. Ripple &amp; noise are measured at 20MHz of bandwidth by using a 12" twisted pair-wire terminated with a 0.1uf &amp; 47uf parallel capacitor.                  3. Tolerance : includes set up tolerance, line regulation and load regulation.                  4. Derating may be needed under low input voltage. Please check the derating curve for more details.                  5. The power supply is considered a component which will be installed a final equipment. The final equipment must be re-confirmed that it still meets EMC directives.                  6. Length of set up time is measured at first cold start. Turning ON/OFF the power supply may lead to increase of the set up time.                  7. Constant current operation region is within the specified output voltage range above. This is the suitable operation region for LED related applications.</p>								

**Mechanical Specification**

Case No.964A Unit:mm

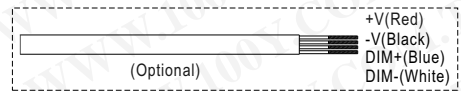
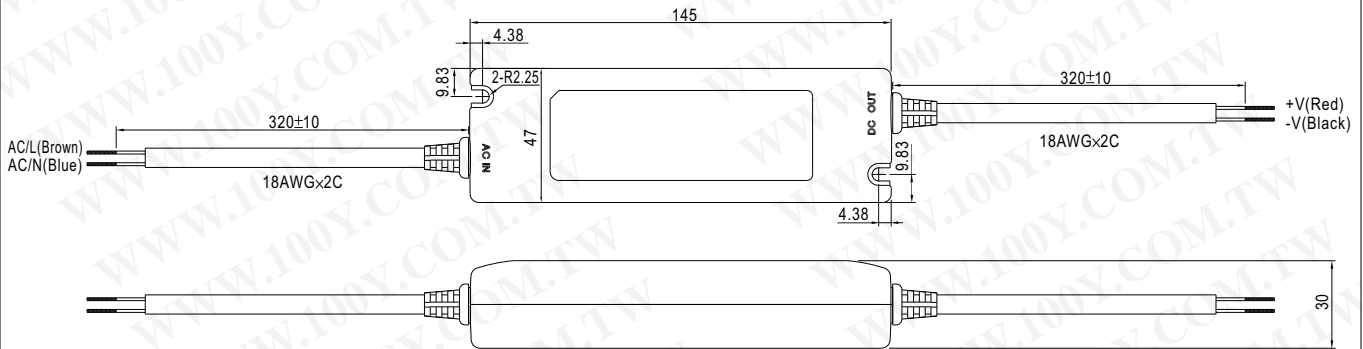

Output voltage and current adjustment : remove the upper case and adjust through SVR1 & SVR2 shown in the diagram.

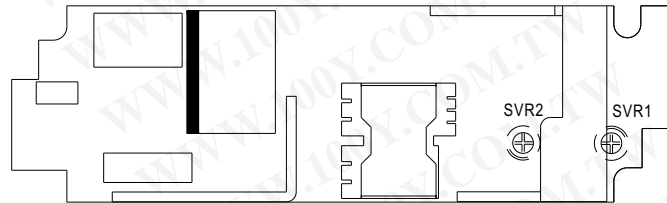

**Block Diagram**

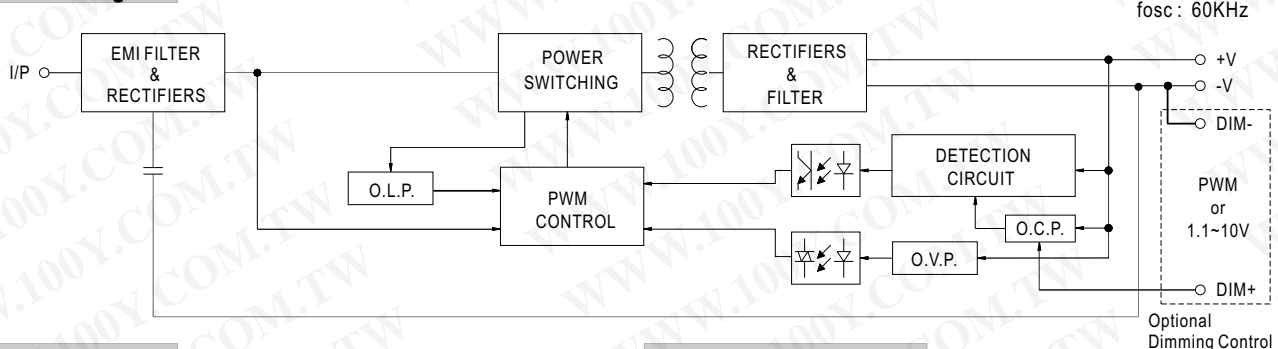

**Derating Curve**

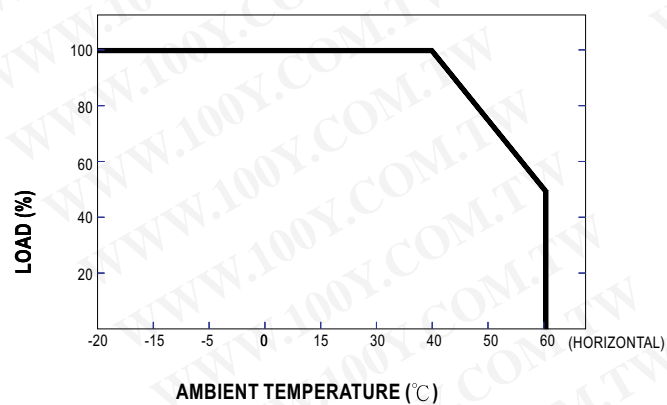

**Static Characteristics**

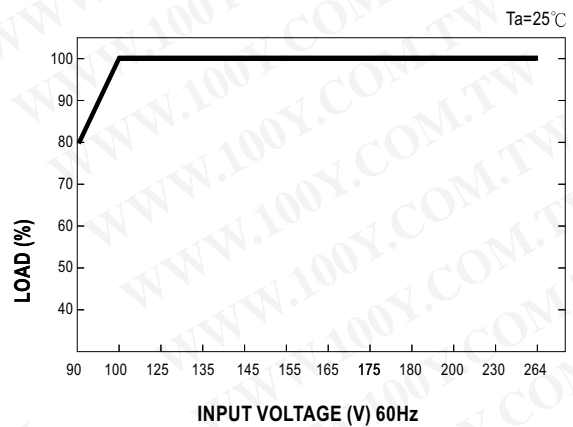

**Dimming Control (Optional)**

Level of output current can be adjusted through the dimming control function.

(1) 1.1~10V

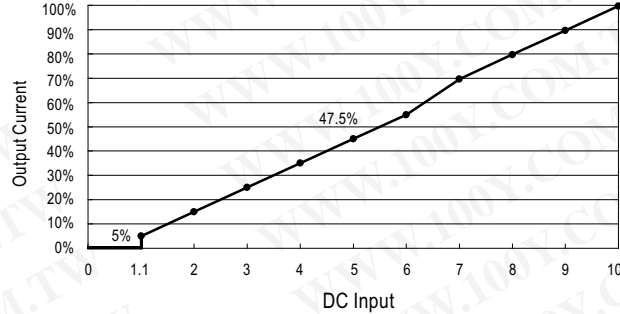
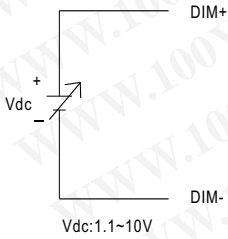

(2) PWM

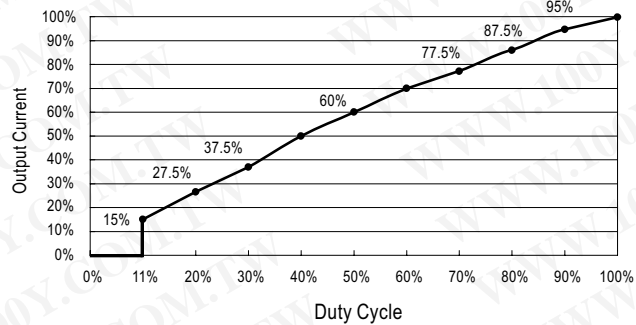
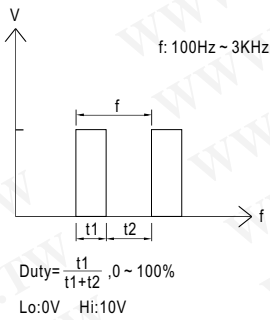

**Recommend Application Deployment (24V)**

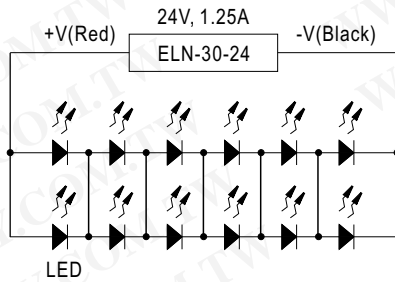

1 to 6 LEDs // 2 strips  
This configuration is based on LED with the following parameters :  
 $V_f = 3.0\sim 3.5V$   $I_f = 600\sim 700mA$

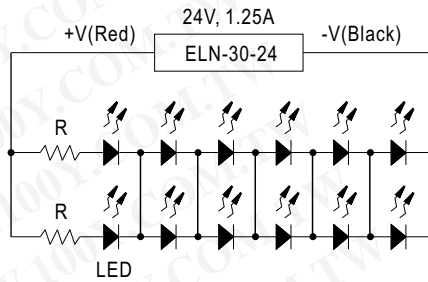

6 LEDs // 1 to 2 strips  
This configuration is based on LED with the following parameters :  
 $V_f = 3.0\sim 3.5V$   $I_f = 600\sim 700mA$   
 $R = 10\text{ ohm}, 10W$

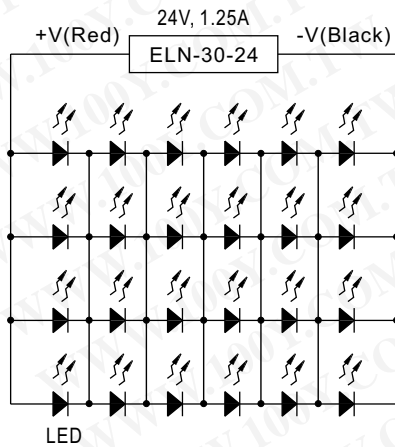

1 to 6 LEDs // 4 strips  
This configuration is based on LED with the following parameters :  
 $V_f = 3.0\sim 3.5V$   $I_f = 300\sim 350mA$

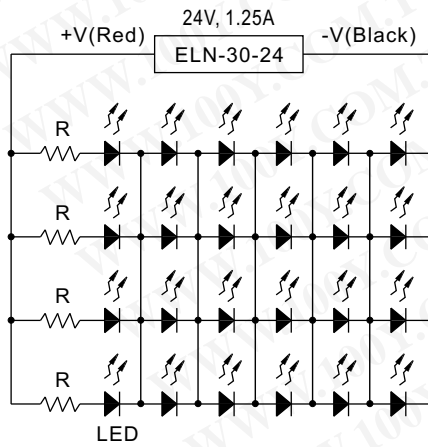

6 LEDs // 1 to 4 strips  
This configuration is based on LED with the following parameters :  
 $V_f = 3.0\sim 3.5V$   $I_f = 300\sim 350mA$   
 $R = 20\text{ ohm}, 3W$