

2547

PROTECTED QUAD POWER DRIVER

UDx2547B (DIP)

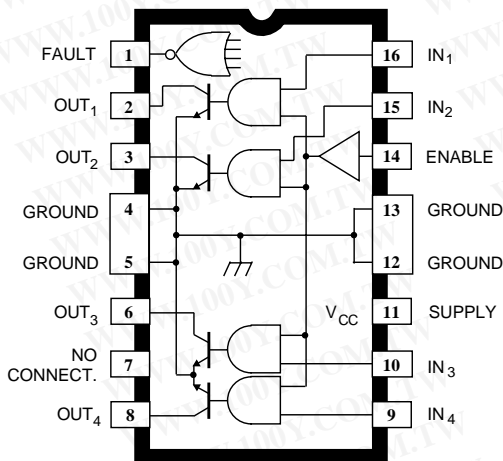

Dwg. PP-018A

ABSOLUTE MAXIMUM RATINGS at $T_A = 25^\circ\text{C}$

Output Voltage, V_{OUT}	60 V
Over-Current Protected Output Voltage, V_{OUT}	25 V
Output Current, I_{OUT}	1.3 A*
FAULT Output Voltage, V_F	40 V
Supply Voltage, V_{CC}	7.0 V
Input Voltage, V_{IN} or V_{EN}	7.0 V
Package Power Dissipation, P_D	See Graph
Operating Temperature Range, T_A	
Prefix 'UDK'	-40°C to +125°C
Prefix 'UDN'	-20°C to +85°C
Prefix 'UDQ'	-40°C to +85°C
Storage Temperature Range, T_S	-55°C to +150°C

*Outputs are current limited at approximately 1.3 A per driver and junction temperature limited if current in excess of 1.3 A is attempted. See Circuit Description and Application for further information.

Providing interface between low-level logic and power loads, the UDK/UDN/UDQ2547B and UDK/UDN/UDQ2547EB quad power drivers combine logic gates and high-current bipolar outputs with complete output protection. Each of the four outputs will sink 600 mA in the ON state. The outputs have a minimum breakdown voltage (load dump) of 60 V and a sustaining voltage of 40 V. The inputs are compatible with TTL and 5 V CMOS logic systems and include internal pull-down resistors to ensure that the outputs remain OFF if the inputs are open-circuited.

Over-current protection for each channel has been designed into these devices and is activated at approximately 1.3 A. It protects each output from short circuits with supply voltages up to 25 V. When a maximum driver output current is reached, that output drive is reduced linearly, maintaining a constant load current. If the over-current or short circuit condition continues, each channel has an independent thermal limit circuit which will sense the rise in junction temperature and turn OFF the individual channel that is at fault. Foldback circuitry decreases the output current if excessive voltage is present across the output and assists in keeping the device within its SOA (safe operating area).

Each output also includes diagnostics for increased device protection. If any output is shorted or opened, the diagnostics can signal the controlling circuitry through a common FAULT pin.

These devices can be used to drive various resistive loads including incandescent lamps (without warming or limiting resistors). With the addition of external output clamp diodes, they can be used to drive inductive loads such as relays, solenoids, or dc stepping motors.

The suffix 'B' devices are 16-pin power DIPs while the suffix 'EB' devices are 28-lead power PLCCs for surface-mount applications. Both packages are of batwing construction to provide for maximum package power dissipation.

FEATURES

- Output SOA Protection
- Diagnostic FAULT Output
- Independent Over-Current Protection for Each Driver
- Independent Thermal Protection for Each Driver
- 600 mA Output Current per Channel
- Low Output-Saturation Voltage
- TTL and 5 V CMOS Compatible Inputs

Always order by complete part number: a prefix to indicate operating temperature range + the basic four-digit part number + a suffix to indicate package style, e.g., **UDK2547EB**.

2547 PROTECTED QUAD POWER DRIVER

UDx2547EB (PLCC)

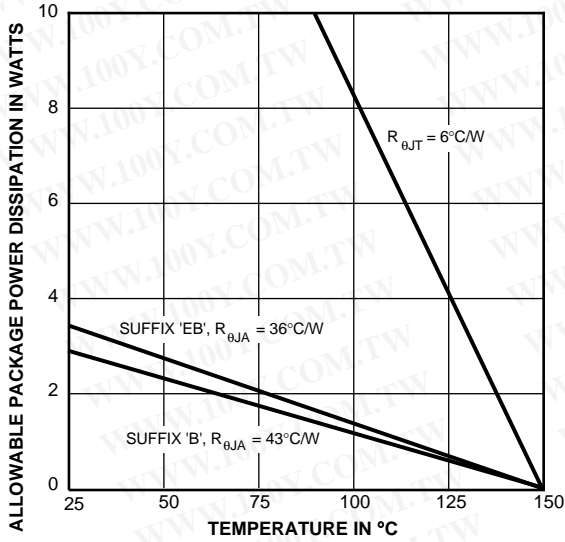

Dwg. GP-004-1A

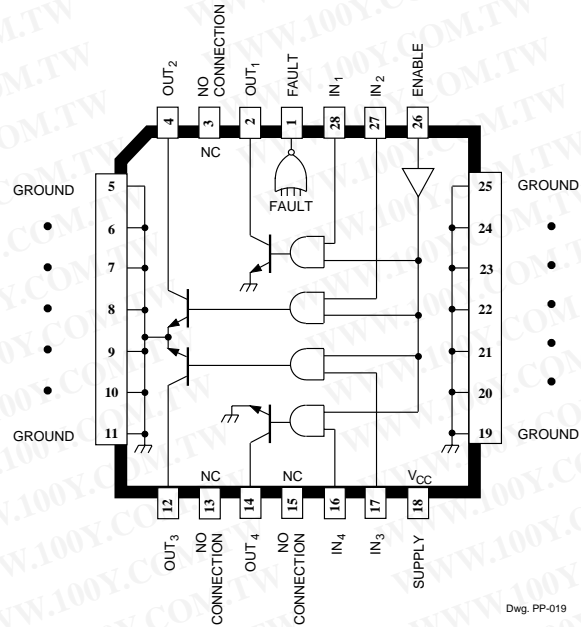

Dwg. PP-019

FUNCTIONAL BLOCK DIAGRAM

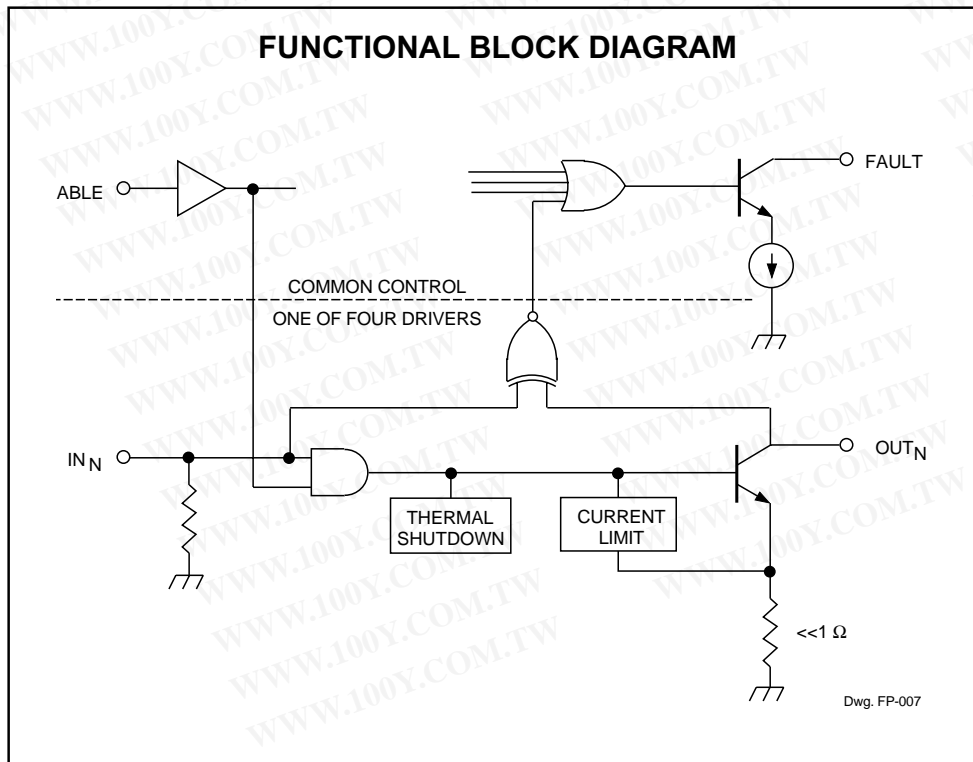

Dwg. FP-007

2547
PROTECTED
QUAD POWER DRIVER

ELECTRICAL CHARACTERISTICS at $T_A = +25^\circ\text{C}$ (prefix 'UDN') or over operating temperature range (prefix 'UDK' or 'UDQ'), $V_{CC} = 4.75\text{ V to }5.5\text{ V}$

Characteristic	Symbol	Test Conditions	Limits			
			Min.	Typ.	Max.	Units
Output Leakage Current*	I_{OUT}	$V_{OUT} = 60\text{ V}, V_{IN} = 0.8\text{ V}, V_{EN} = 2.0\text{ V}$	—	30	150	μA
		$V_{OUT} = 60\text{ V}, V_{IN} = 2.0\text{ V}, V_{EN} = 0.8\text{ V}$	—	30	150	μA
Output Sustaining Voltage	$V_{OUT(SUS)}$	$I_{OUT} = 100\text{ mA}, V_{IN} = 0.8\text{ V}, V_{CC} = \text{Open}$	40	—	—	V
Output Saturation Voltage	$V_{OUT(SAT)}$	$I_{OUT} = 400\text{ mA}$	—	—	300	mV
		$I_{OUT} = 500\text{ mA}$	—	—	400	mV
		$I_{OUT} = 600\text{ mA}$	—	—	550	mV
Over-Current Limit	I_{OUT}	5 ms PulseTest, $V_{OUT} = 5.0\text{ V}$	—	1.3	1.7	A
Input Voltage	Logic 1	$V_{IN(1)}$ or $V_{EN(1)}$	2.0	—	—	V
	Logic 0	$V_{IN(0)}$ or $V_{EN(0)}$	—	—	0.8	V
Input Current	Logic 1	$V_{IN(1)}$ or $V_{EN(1)} = 2.0\text{ V}$	—	—	60	μA
	Logic 0	$V_{IN(0)}$ or $V_{EN(0)} = 0.8\text{ V}$	10	—	—	μA
Fault Output Leakage Current	I_F	$V_F = 40\text{ V}$	—	<1.0	2.0	μA
Fault Output Current	I_F	$V_F = 40\text{ V}$, Driver Outputs Open, $V_{IN} = 0.8\text{ V}, V_{EN} = 2.0\text{ V}$	40	60	80	μA
Fault Output Saturation Voltage	$V_{F(SAT)}$	$I_F = 30\text{ }\mu\text{A}$	—	0.1	0.4	V
Total Supply Current	I_{CC}	All Outputs ON	—	45	50	mA
		All Outputs OFF	—	6.0	10	mA
Thermal Shutdown	T_J		—	165	—	$^\circ\text{C}$
Thermal Hysteresis	ΔT_J		—	15	—	$^\circ\text{C}$

Typical Data is for design information only.
 *Measurement includes XOR input current and other elements.

TRUTH TABLE

STATUS	IN_N	ENABLE	OUT_N	FAULT
Normal Load	H	H	L	H
	L	H	H	H
	X	L	H	H
Over-Current or Short to Supply	H	H	R	L
Thermal Fault	H	H	H	L
Open Load or Short to Ground	L	H	L	L

X = Don't care. R = Linear drive, current limited.

2547 PROTECTED QUAD POWER DRIVER

CIRCUIT DESCRIPTION AND APPLICATION

These devices monitor their outputs for open or shorted conditions. Both conditions are sensed by comparing the input and output states. Note that the FAULT output is operational only if the ENABLE input is high. When a fault condition is sensed, the FAULT output will go to a low state. An external FAULT output filter capacitor (0.1 μ F) is recommended to eliminate erroneous switching.

INCANDESCENT LAMP DRIVER

High incandescent lamp turn-ON/in-rush currents can contribute to poor lamp reliability and destroy semiconductor lamp drivers.

Warming (parallel) or current-limiting (series) resistors protect both driver and lamp but use significant power either when the lamp is OFF or when the lamp is ON, respectively. Lamps with steady-state current ratings up to 600 mA can be driven without the need for warming or current-limiting resistors, if lamp turn-ON time is not a concern.

When an incandescent lamp is initially turned ON, the cold filament is at minimum resistance and would normally allow a 10x to 12x in-rush current. With these drivers, during turn-ON, the high in-rush current is sensed by the internal low-value sense resistor, drive current to the output stage is diverted by the shunting transistor, the output stage operates in a linear mode, and the load current is limited to approximately 1.3 A. During lamp warmup, the filament resistance increases to its maximum value, the output driver goes into saturation and applies maximum rated voltage to the lamp.

INDUCTIVE LOAD DRIVER

With the addition of external clamp diodes, bifilar (unipolar) stepper motors and other inductive loads can be driven directly. The external diodes prevent damage to the output transistors by suppressing the high-voltage spikes that occur when turning OFF an inductive load. For rapid current decay (fast turn-OFF speeds), the use of Zener diodes will raise the flyback voltage and improve performance. However, the peak voltage must not exceed the specified minimum sustaining voltage ($V_{\text{SUPPLY}} + V_Z + V_F \leq V_{\text{OUT(SUS)}}$).

OVER-CURRENT CONDITIONS

In the event of a shorted load, or stalled motor, the load current will attempt to increase. As described above, the drive current to the affected output stage is linearly reduced (limiting the load current to about 1.3 A), causing the output stage to go linear. As the junction temperature of the output stage increases, the thermal shutdown circuit will shut OFF the affected output. If the fault condition is corrected, the output driver will return to its normal saturated condition.

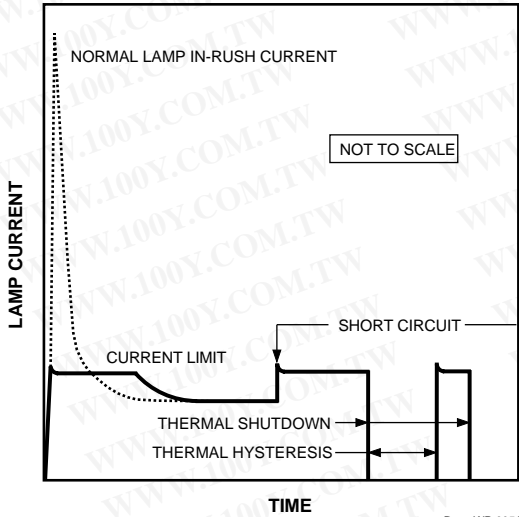

2547 PROTECTED QUAD POWER DRIVER

UDN2547B and UDQ2547B

Dimensions in Inches
(controlling dimensions)

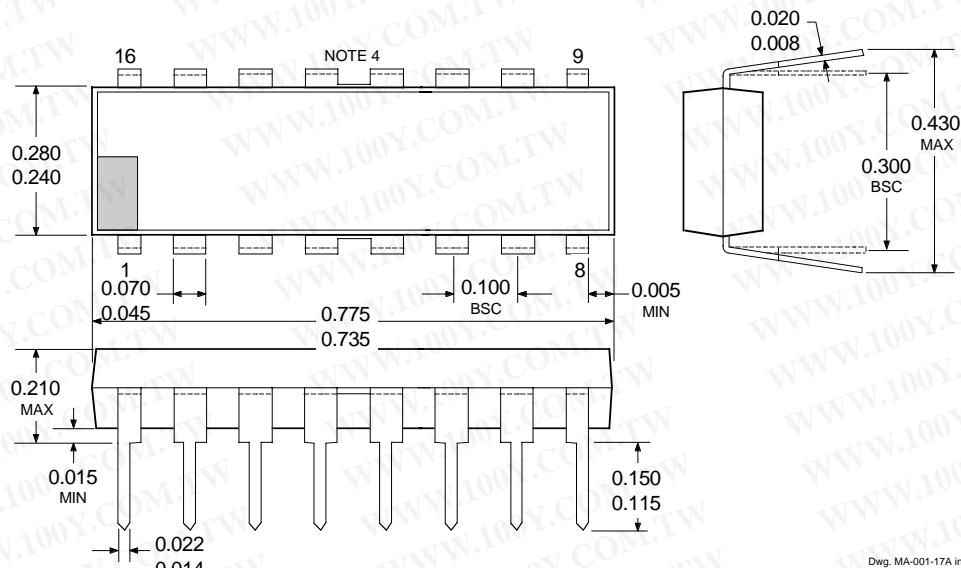

Dimensions in Millimeters
(for reference only)

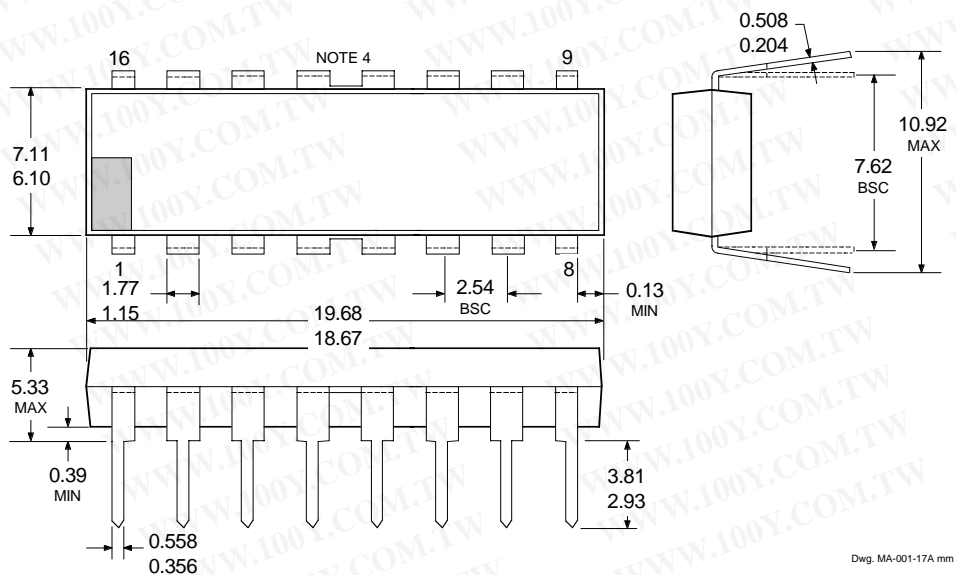

- NOTES:
- Exact body and lead configuration at vendor's option within limits shown.
 - Lead spacing tolerance is non-cumulative
 - Lead thickness is measured at seating plane or below.
 - Webbed lead frame. Leads 4, 5, 12, and 13 are internally one piece.

2547
PROTECTED
QUAD POWER DRIVER

UDN2547EB and UDQ2547EB

Dimensions in Inches
 (controlling dimensions)

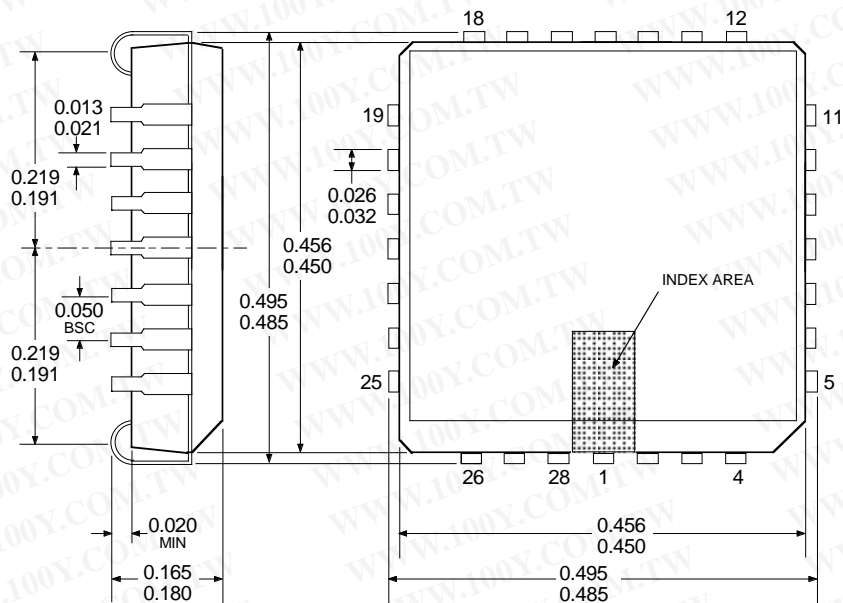

Dwg. MA-005-28A in

Dimensions in Millimeters
 (for reference only)

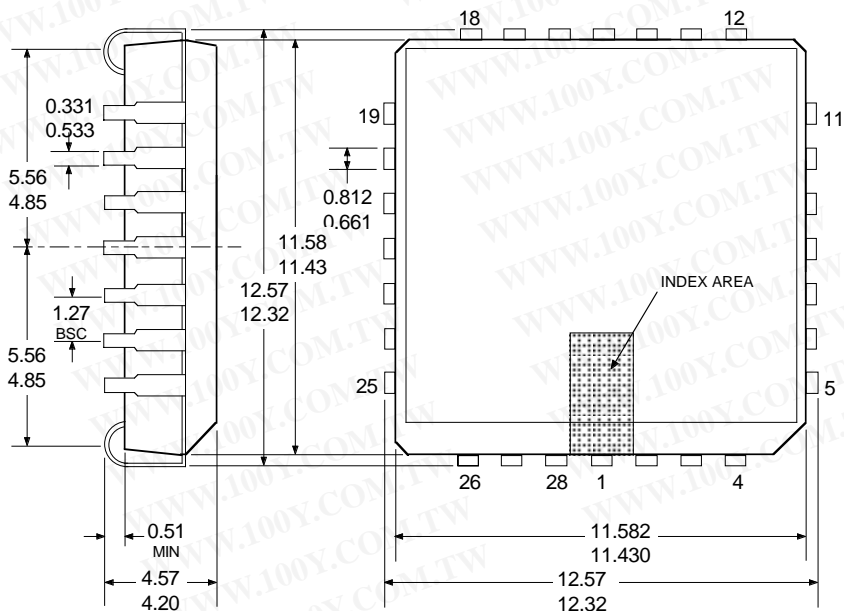

Dwg. MA-005-28A mm

- NOTES:
1. Exact body and lead configuration at vendor's option within limits shown.
 2. Lead spacing tolerance is non-cumulative
 3. Webbed lead frame. Leads 5 through 11 and 19 through 25 are internally one piece.

勝特力材料 886-3-5753170

勝特力电子(上海) 86-21-54151736

勝特力电子(深圳) 86-755-83298787

[Http://www.100y.com.tw](http://www.100y.com.tw)

2547

**PROTECTED
QUAD POWER DRIVER**

The products described here are manufactured under one or more U.S. patents or U.S. patents pending.

Allegro MicroSystems, Inc. reserves the right to make, from time to time, such departures from the detail specifications as may be required to permit improvements in the performance, reliability, or manufacturability of its products. Before placing an order, the user is cautioned to verify that the information being relied upon is current.

Allegro products are not authorized for use as critical components in life-support devices or systems without express written approval.

The information included herein is believed to be accurate and reliable. However, Allegro MicroSystems, Inc. assumes no responsibility for its use; nor for any infringement of patents or other rights of third parties which may result from its use.

2547
PROTECTED
QUAD POWER DRIVER

POWER SINK DRIVERS

IN ORDER OF 1) OUTPUT CURRENT, 2) OUTPUT VOLTAGE, 3) NUMBER OF DRIVERS

Output Ratings *			Features					Part Number [†]
mA	V	#	Serial Input	Latched Drivers	Diode Clamp	Outputs	Internal Protection	
75	17	8	X	X	–	constant current	–	6275
	17	16	X	X	–	constant current	–	6276
100	20	8	–	–	–	saturated	–	2595
	30	32	X	X	–	–	–	5833
	40	32	X	X	–	saturated	–	5832
	50	8	–	–	–	addressable decoder/driver	DMOS	6B259
	50	8	–	X	–	–	DMOS	6B273
	50	8	X	X	–	–	DMOS	6B595
120	24	8	X	X	–	constant current	–	6277
250	50	8	–	–	–	addressable decoder/driver	DMOS	6259
	50	8	–	X	–	–	DMOS	6273
	50	8	X	X	–	–	DMOS	6595
	50	8	–	–	X	saturated	–	2596
	60	4	–	–	X	saturated	X	2557
350	50	4	–	X	X	–	–	5800
	50	7	–	–	X	–	–	2003
	50	7	–	–	X	–	–	2004
	50	8	–	–	X	–	–	2803
	50	8	–	X	X	–	–	5801
	50	8	X	X	–	–	–	5821
	50	8	X	X	X	–	–	5841
	50	8	–	–	–	addressable decoder/driver	DMOS	6A259
	50	8	X	X	–	–	DMOS	6A595
	80	8	X	X	–	–	–	5822
	80	8	X	X	X	–	–	5842
	95	7	–	–	X	–	–	2023
95	7	–	–	X	–	–	2024	
450	30	28	dual 4- to 14-line decoder/driver			–	–	6817
600	60	4	–	–	–	saturated	X	2547
	60	4	–	–	X	saturated	X	2549 and 2559
700	60	4	–	–	X	saturated	X	2543
750	50	8	–	–	X	saturated	–	2597
1000	46	4	stepper motor controller/driver			MOS	–	7024 and 7029
1200	46	4	microstepping controller/driver			MOS	–	7042
1250	50	4	stepper motor translator/driver			–	X	5804
1800	50	4	–	–	X	–	–	2540
3000	46	4	stepper motor controller/driver			MOS	–	7026
	46	4	microstepping controller/driver			MOS	–	7044
4000	50	4	–	–	X	–	–	2878

* Current is maximum specified test condition, voltage is maximum rating. See specification for sustaining voltage limits or over-current protection voltage limits.

† Complete part number includes additional characters to indicate operating temperature range and package style.

