

型号 Type :

SM420561N

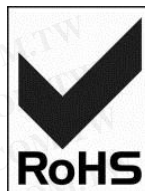

■ 产品特征 FEATURES:

- 高可靠性和高稳定性

**High intensity and reliability**

- 高品质、和低功耗、低成本

**High quality, Low power requirement and low cost**

- IC 易兼容、易装配

**IC compatible , Easy assembly**

- 符合 RoHS 指令要求

**Meet RoHS EU Directive**

- 人体防静电承受能力 2000V (HMB)

**ESD 2000V(HMB)**

勝特力材料 886-3-5753170  
勝特力电子(上海) 86-21-34970699  
勝特力电子(深圳) 86-755-83298787  
[Http://www.100y.com.tw](http://www.100y.com.tw)

■ 产品描述 DESCRIPTION:

- 0.56 英寸单位数码管

**0.56 Inch Single Digits Display**

- 极性共阴

**Common Cathode**

- 黑面, 白胶

**Black face, white segment**

- 发光颜色

**Luminous Color:**

- 1、红色 RED

2、

3、

4、

5、

- 晶片材质

**Chips Materials**

- 1、AlGaInP

2、

3、

4、

5、

型号 Type :

SM420561N

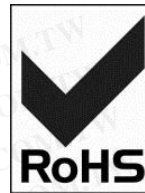

■ 产品最大绝对参数值 (Ta: 25°C) ABSOLUTE MAXIMUM RATINGS AT Ta=25°C:

PARAMETER 项目	SYMBOL 符号	RED 红色	UNIT 单位
Power Dissipation Per Segment 功耗	PAD	50	mw
Reverse Voltage Per Segment 反向耐压	VR	5	V
Continuous Forward Current Per Segment 最大使用电流	IAF	20	mA
Peak Forward Current Per Segment(Duty-0.1,1KHz) 最大峰值电流	IPF	60	mA
Operating Temperature Range 工作温度	TOPr	-20°C to 80°C	
Storage Temperature Range 贮藏温度	Tstg	-30°C to 85°C	
Lead Soldering Temperature 260°C at 1.6mm From Body for 3 second 焊接温度 260°C/3 秒 距离胶体 1.6mm 以上			

■ 产品光电参数值 (Ta: 25°C) ELECTRICAL/OPTICAL CHARACTERISTICS AT Ta=25°C:

PARAMETER 项目	SYMBOL 符号	TEST CONDITION 测试条件	Color 颜色	MIN 最小值	TYP 标准值	MAX 最大值	UNIT 单位
Forward Voltage ,Per Segment 正向压降	VF	IF=20mA	红色 RED	1.9	2	2.5	V
Reverse Current , Per Segment 反向漏电流	IR	VR=5V	红色 RED			50	μA
Peak Emission Wavelength 峰值波长	λp	IF=20mA	红色 RED	630	633	637	nm
Luminous Intensity Per Segment 法向光强	IV	IF=20mA	红色 RED	23	25	28	mcd

型号 Type :

SM420561N

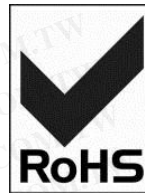

RELATIVE INTENSITY VS. WAVELENGTH

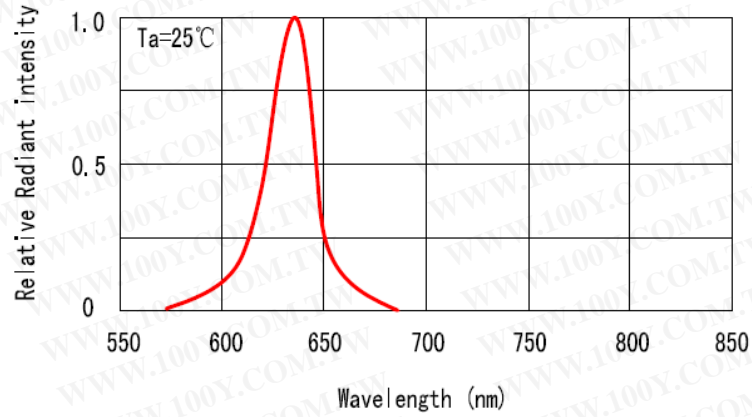

FORWARD CURRENT VS. FORWARD VOLTAGE

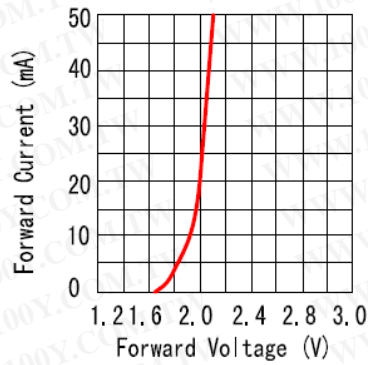

LUMINOUS INTENSITY VS. FORWARD CURRENT

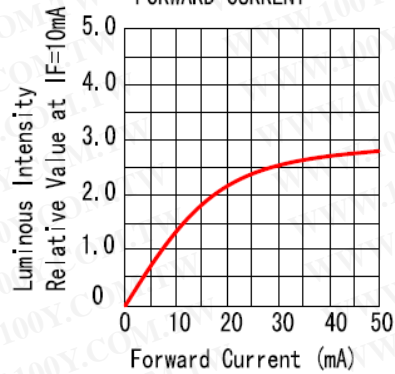

ALLOWABLE FORWARD CURRENT AMBIENT TEMPERATURE

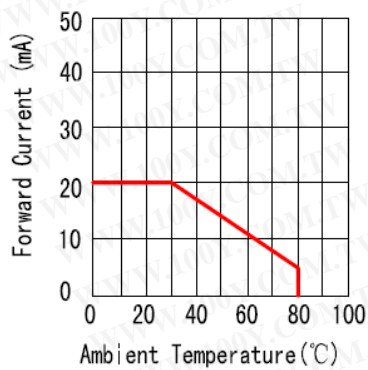

LUMINOUS INTENSITY VS. AMBIENT TEMPERATURE

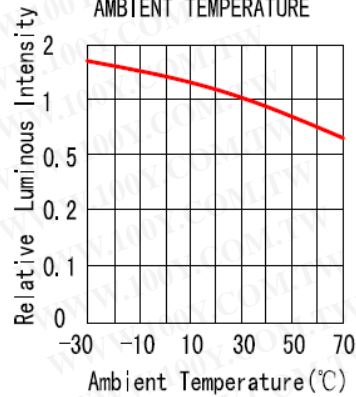

型号 Type :

SM420561N

勝特力材料 886-3-5753170  
勝特力电子(上海) 86-21-34970699  
勝特力电子(深圳) 86-755-83298787  
[Http://www.100y.com.tw](http://www.100y.com.tw)

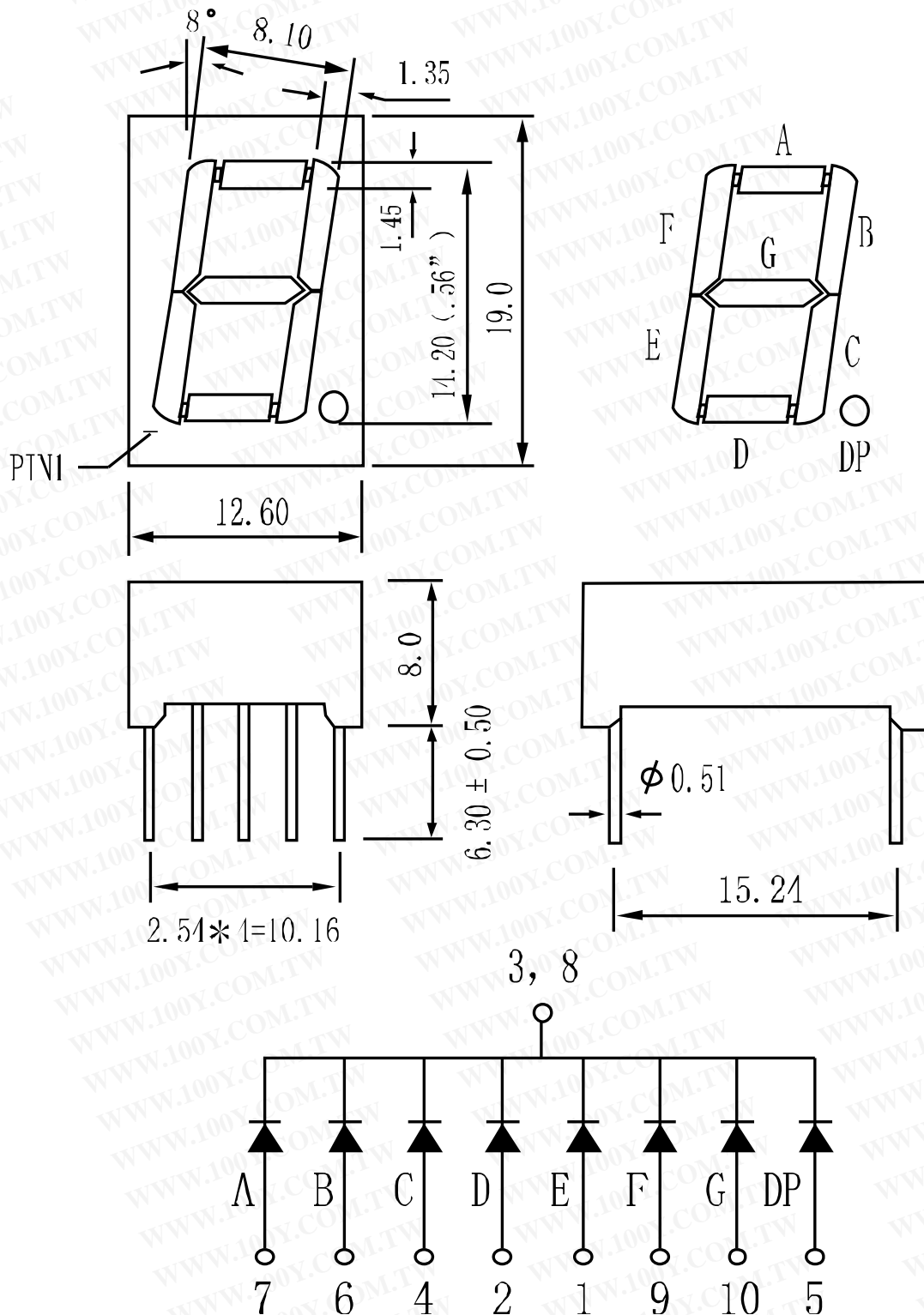
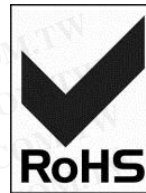

NOTES : 1. All dimensions are in millimeters. (inches)

2. Tolerance is  $\pm 0.25(0.010)$  unless otherwise specified.