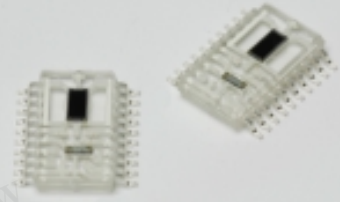

Photo IC for laser beam synchronous detection

S5049-103

Photo IC for start timing detection for precise printing



S5049-103 uses a dual-element PIN photodiode and compares the two photocurrent signals to maintain a highly stable output even when input laser power or ambient temperature fluctuates.

Features

- Photo IC for precision printing
Stable output versus laser power or temperature variations
- For detection of low power laser beams
- Photodiode length: 2.4 mm

Applications

- Print start timing detection for laser printers, digital copiers, fax machines, etc.

■ Absolute maximum ratings (Ta=25 °C, Vcc1=Vcc2=Vcc)

Parameter	Symbol	Value	Unit
Supply voltage	Vcc	-0.5 to +7	V
Power dissipation *1	P	150	mW
Output voltage	Vo	-0.5 to Vcc	V
Output current	Io	20	mA
Ro1, Ro2 terminal current	IRO	5	mA
Operating temperature	Topr	-25 to +80	°C
Storage temperature	Tstg	-40 to +85	°C
Soldering	-	230 °C, 5 s	-

*1: Derate power dissipation at a rate of 2 mW/°C above Ta=25 °C.

■ Electrical and optical characteristics (Ta=25 °C, λ=780 nm, Vcc1=Vcc2=Vcc=5 V, Ro1=Ro2=5.1 kΩ, unless otherwise noted)

Parameter	Symbol	Condition	Min.	Typ.	Max.	Unit
Supply voltage	Vcc		4.5	5.0	5.5	V
High level output voltage	VOH	Pin=0	4.9	-	-	V
Low level output voltage	VOL	Pin=200 μW, IoL=10 mA	-	0.4	0.6	V
Current consumption	Icc	Pin=0, at high level output	-	6.0	8.0	mA
		Pin=200 μW, at low level output	-	8.0	11.0	mA
Threshold input power	PTH		25	35	45	μW
H→L propagation delay time variation	ΔtPHL	Pin=200 μW at center ΔPin=±10 % *2	-	-	±6	ns
L→H propagation delay time variation	ΔtPLH		-	±50	-	ns
Rise time	tr	RL=510 Ω, CL=15 pF	-	60	180	ns
Fall time	tf		-	20	100	ns

*2: Beam diameter $\phi (1/e^2) = 100 \mu\text{m}$, scan speed=0.5 mm/μs
 Not including jitter caused by polygon mirror non-uniformity, etc.

■ Equivalent circuit

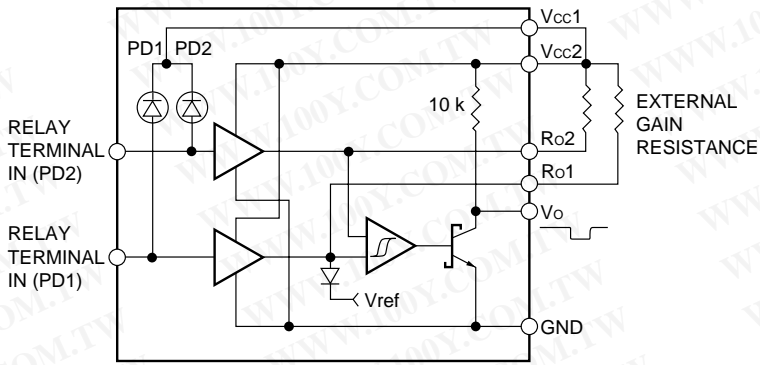

■ Output waveforms of terminals 8, 11 and 13

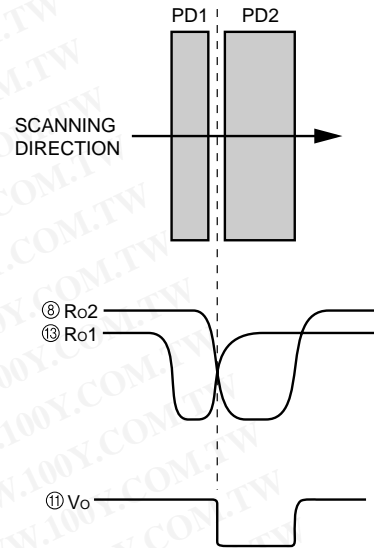

■ Dimensional outline (unit: mm)

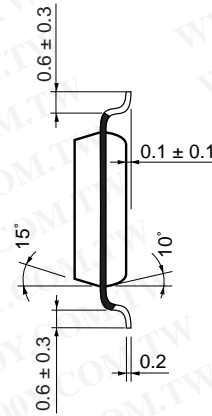
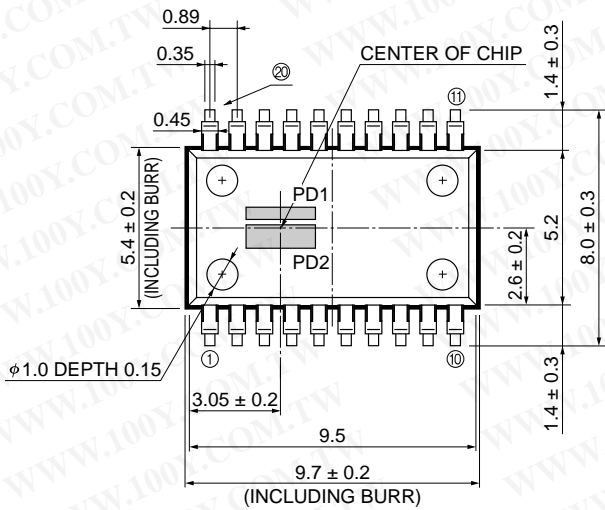

Tolerance unless otherwise noted: $\pm 0.1, \pm 2^\circ$
Shaded area indicates burr.

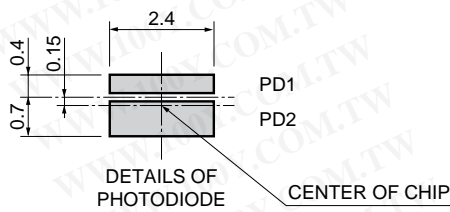
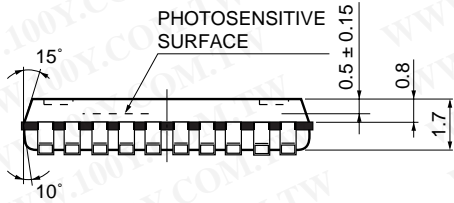

Tolerance unless otherwise noted: ± 0.03

①	
②	
③	Vcc1
④	
⑤	
⑥	[IN (PD2)]
⑦	GND
⑧	Ro2
⑨	GND
⑩	GND
⑪	Vo
⑫	GND
⑬	Ro1
⑭	Vcc2
⑮	[IN (PD1)]
⑯	
⑰	Vcc1
⑱	
⑳	

KPICA0007EC

勝特力材料 886-3-5753170
勝特力电子(上海) 86-21-54151736
勝特力电子(深圳) 86-755-83298787
[Http://www.100y.com.tw](http://www.100y.com.tw)