

Si PIN photodiode S6801/S6968 series

φ14 mm lens plastic package

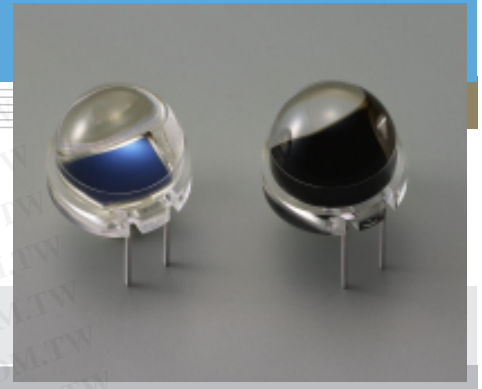

S6801/S6968 series is a Si PIN photodiode molded into a plastic package with a φ14 mm lens. Four types are provided, S6801, S6968 with a clear plastic package and S6801-01, S6968-01 with a visible-cut package.

Features

- Plastic packages with φ14 mm lens
- High-speed response (S6968 series): 50 MHz Typ. ($V_R=10$ V, $\lambda=850$ nm)
- High sensitivity (S6801, S6968): 0.63 A/W ($\lambda=850$ nm)
- Directivity: 35° (half angle)
- Visible-cut type: S6801-01, S6968-01
- Active area size: φ14 mm (lens diameter)
- Effective active area: 150 mm²

Applications

- Spatial light transmission
- Optical communication
- Optical data link
- High-speed optical measurement
- Optical switch
- Laser radar

勝特力材料 886-3-5753170
 勝特力电子(上海) 86-21-34970699
 勝特力电子(深圳) 86-755-83298787
[Http://www.100y.com.tw](http://www.100y.com.tw)

General ratings / Absolute maximum ratings

Type No.	Package	Active area size (mm)	Effective active area (mm ²)	Absolute maximum ratings		
				Reverse voltage V_R Max. (V)	Operating temperature T_{opr} (°C)	Storage temperature T_{stg} (°C)
S6801	Plastic	φ14	150	35	-25 to +85	-40 to +100
S6801-01						
S6968						
S6968-01						

Electrical and optical characteristics

Type No.	Spectral response range λ (nm)	Peak sensitivity wavelength λ_p (nm)	Photo sensitivity S $\lambda=850$ nm		Short circuit current I_{sc} 100 lx 2856 K		Dark current I_D $V_R=10$ V		Temp. coefficient of I_D T_{CID} (times/°C)	Cut-off frequency f_c $V_R=10$ V $R_L=50$ Ω $\lambda=850$ nm, -3 dB		Terminal capacitance C_t $V_R=10$ V $f=1$ MHz		Half * angle (degree)
			Min. (A/W)	Typ. (A/W)	Min. (μA)	Typ. (μA)	Typ. (nA)	Max. (nA)		Min. (MHz)	Typ. (MHz)	Typ. (pF)	Max. (pF)	
S6801	320 to 1100	960	0.57	0.63	95	120	0.5	10	1.15	7	15	40	80	±35
S6801-01	700 to 1100		0.5	0.55	64	80								
S6968	320 to 1060	920	0.57	0.63	83	104	0.5	5		30	50	50	100	
S6968-01	700 to 1060		0.5	0.55	57	72								

* Photocurrent generated in a photodiode varies depending on the incident light angle. The half angle is the incident light angle at which the photocurrent is 50 % of that generated when the incident light is perpendicular to the photodiode.

Spectral response

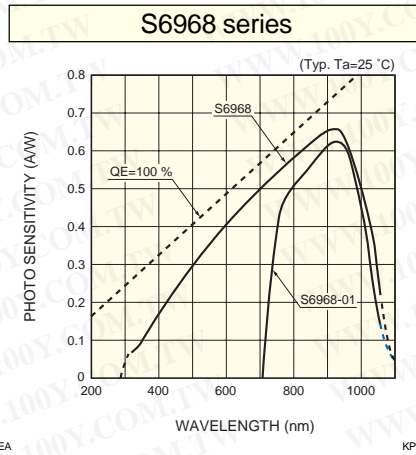
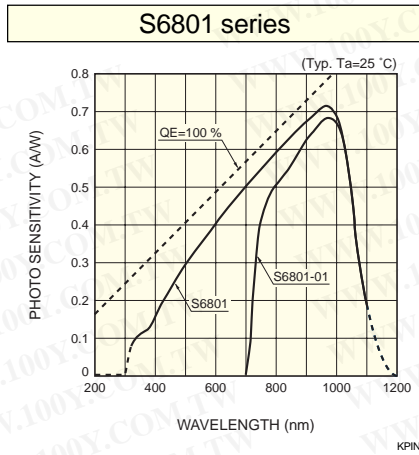

Dark current vs. reverse voltage

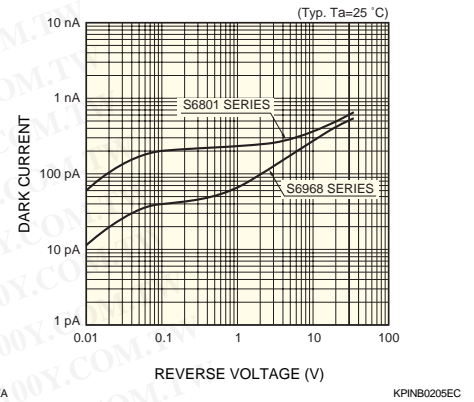

Cut-off frequency vs. reverse voltage

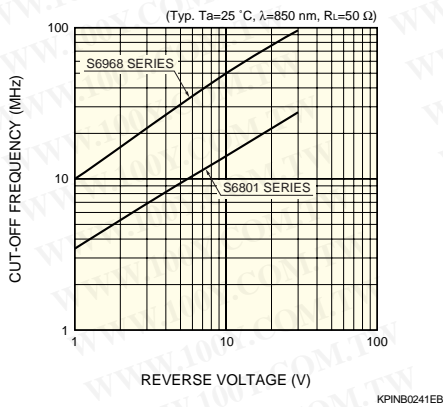

Terminal capacitance vs. reverse voltage

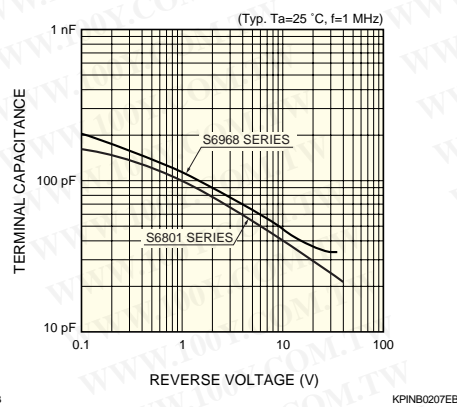

Directivity

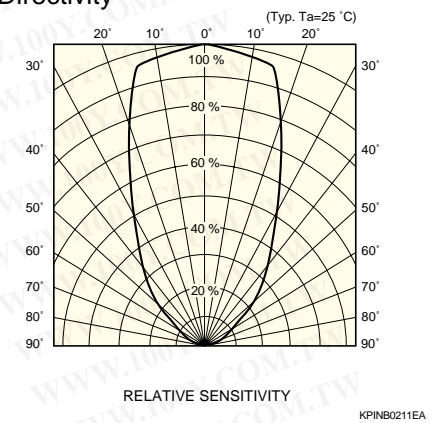

Dimensional outline

(unit: mm, tolerance unless otherwise noted: ±0.1)

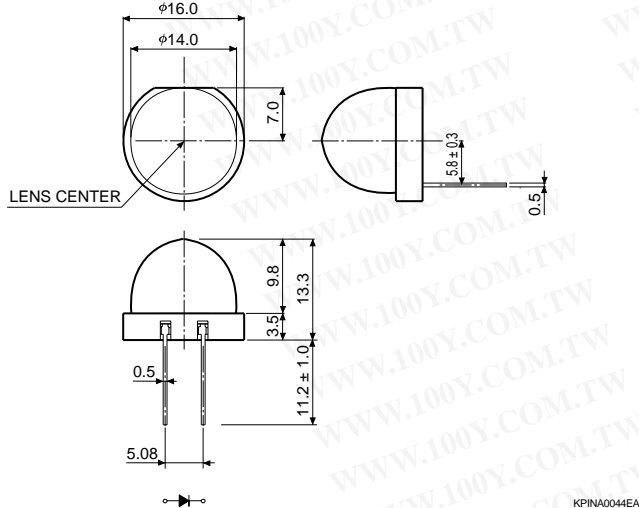

勝特力材料 886-3-5753170
 勝特力电子(上海) 86-21-34970699
 勝特力电子(深圳) 86-755-83298787
[Http://www.100y.com.tw](http://www.100y.com.tw)

HAMAMATSU

Information furnished by HAMAMATSU is believed to be reliable. However, no responsibility is assumed for possible inaccuracies or omissions. Specifications are subject to change without notice. No patent rights are granted to any of the circuits described herein. ©2006 Hamamatsu Photonics K.K.

HAMAMATSU PHOTONICS K.K., Solid State Division

1126-1 Ichino-cho, Higashi-ku, Hamamatsu City, 435-8558 Japan, Telephone: (81) 53-434-3311, Fax: (81) 53-434-5184, www.hamamatsu.com

U.S.A.: Hamamatsu Corporation: 360 Foothill Road, P.O.Box 6910, Bridgewater, N.J. 08807-0910, U.S.A., Telephone: (1) 908-231-0960, Fax: (1) 908-231-1218

Germany: Hamamatsu Photonics Deutschland GmbH: Arzbergerstr. 10, D-82211 Herrsching am Ammersee, Germany, Telephone: (49) 08152-3750, Fax: (49) 08152-2658

France: Hamamatsu Photonics France S.A.R.L.: 19, Rue du Saule Trappu, Parc du Moulin de Massy, 91882 Massy Cedex, France, Telephone: 33-(1) 69 53 71 00, Fax: 33-(1) 69 53 71 10

United Kingdom: Hamamatsu Photonics UK Limited: 2 Howard Court, 10 Twin Road, Welwyn Garden City, Hertfordshire AL7 1BW, United Kingdom, Telephone: (44) 1707-294888, Fax: (44) 1707-325777

North Europe: Hamamatsu Photonics Norden AB: Smidesvägen 12, SE-171 41 Solna, Sweden, Telephone: (46) 8-509-031-00, Fax: (46) 8-509-031-01

Italy: Hamamatsu Photonics Italia S.R.L.: Strada della Moia, 1/E, 20020 Arese, (Milano), Italy, Telephone: (39) 02-935-81-733, Fax: (39) 02-935-81-741