

H11C1

H11C2

H11C3

H11C4

H11C5

H11C6

PACKAGE

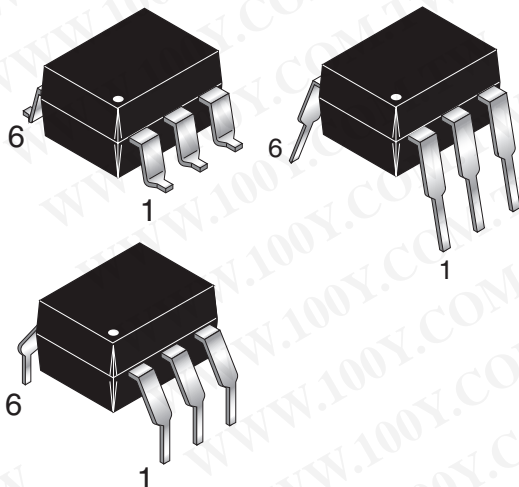

SCHEMATIC

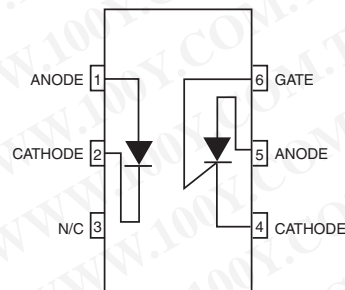

DESCRIPTION

The H11C series consists of a gallium-arsenide infrared emitting diode optically coupled with a light activated silicon controlled rectifier in a dual-in-line package

FEATURES

- High efficiency, low degradation, liquid epitaxial LED
- Underwriters Laboratory (UL) recognized fl File #E90700
- VDE recognized (File #94766) – ordering option .300. (e.g., H11C1.300)
- 200V/400V Peak blocking voltage
- High isolation voltage - 5300V AC (RMS)

APPLICATIONS

- Low power logic circuits
- Telecommunications equipment
- Portable electronics
- Solid state relays
- Interfacing coupling systems of different potentials and impedances.
- 10 A, T²L compatible, solid state relay
- 25 W logic indicator lamp driver
- 200 V symmetrical transistor coupler (H11C1, H11C2, H11C3)
- 400 V symmetrical transistor coupler (H11C4, H11C5, H11C6)

勝特力材料 886-3-5753170
 勝特力电子(上海) 86-21-34970699
 勝特力电子(深圳) 86-755-83298787
[Http://www.100y.com.tw](http://www.100y.com.tw)

H11C1

H11C2

H11C3

H11C4

H11C5

H11C6

Parameter	Symbol	Device	Value	Units
TOTAL DEVICE				
Storage Temperature	T_{STG}	All	-55 to +150	°C
Operating Temperature	T_{OPR}	All	-55 to +100	°C
Lead Solder Temperature	T_{SOL}	All	260 for 10 sec	°C
EMITTER				
Continuous Forward Current	I_F	All	60	mA
Reverse Voltage	V_R	All	6	V
Forward Current - Peak (1 μ s pulse, 300 pps)	$I_{F(pk)}$	All	3.0	A
LED Power Dissipation Derate above 25°C	P_D	All	100 1.33	mW mW/°C
DETECTOR				
Power Dissipation (ambient) Derate linearly above 25°C ambient	P_D	All	400 5.3	mW mW/°C
Power Dissipation (case) Derate linearly above 25°C case	P_D	All	1 13.3	W mW/°C
Peak Reverse Gate Voltage	V_{GR}	All	6	V
RMS On-State Current	$I_{DM (RMS)}$	All	300	mA
Peak On-State Current (100 μ S, 1% duty cycle)	$I_{DM (Peak)}$	All	10	A
Surge Current (10ms)	$I_{DM (Surge)}$	All	5	A
Peak Forward Voltage	V_{DM}	H11C1, H11C2, H11C3	200	V
Peak Forward Voltage	V_{DM}	H11C4, H11C5, H11C6	400	V

勝特力材料 886-3-5753170
 勝特力电子(上海) 86-21-34970699
 勝特力电子(深圳) 86-755-83298787
[Http://www.100y.com.tw](http://www.100y.com.tw)

H11C1

H11C2

H11C3

H11C4

H11C5

H11C6

ELECTRICAL CHARACTERISTICS ($T_A = 25^\circ\text{C}$ Unless otherwise specified.)

INDIVIDUAL COMPONENT CHARACTERISTICS

Parameter	Test Conditions	Symbol	Device	Min	Typ*	Max	Unit
EMITTER							
Input Forward Voltage	$I_F = 10\text{ mA}$	V_F	All		1.2	1.5	V
Reverse Leakage Current	$V_R = 3\text{ V}$	I_R	All			10	μA
Capacitance	$V_F = 0\text{ V}, f = 1.0\text{ MHz}$	C_J	All		50		pF
DETECTOR							
Off-State Voltage	$R_{GK} = 10\text{ k}\Omega, T_A = 100^\circ\text{C}, I_D = 50\mu\text{A}$	V_{DM}	H11C1, H11C2, H11C3	200			V
	$R_{GK} = 10\text{ k}\Omega, T_A = 100^\circ\text{C}, I_D = 150\mu\text{A}$		H11C4, H11C5, H11C6	400			
Reverse Voltage	$R_{GK} = 10\text{ k}\Omega, T_A = 100^\circ\text{C}, I_R = 50\mu\text{A}$	V_{RM}	H11C1, H11C2, H11C3	200			V
	$R_{GK} = 10\text{ k}\Omega, T_A = 100^\circ\text{C}, I_R = 150\mu\text{A}$		H11C4, H11C5, H11C6	400			
On-State Voltage	$I_{TM} = 300\text{ mA}$	V_{TM}	All		1.2	1.3	V
Off-State Current	$V_{DM} = 200\text{ V}, T_A = 100^\circ\text{C}, I_F = 0\text{ mA}, R_{GK} = 10\text{ k}\Omega$	I_{DM}	H11C1, H11C2, H11C3			50	μA
	$V_{DM} = 400\text{ V}, T_A = 100^\circ\text{C}, I_F = 0\text{ mA}, R_{GK} = 10\text{ k}\Omega$		H11C4, H11C5, H11C6			150	
Reverse Current	$V_{RM} = 200\text{ V}, T_A = 100^\circ\text{C}, I_F = 0\text{ mA}, R_{GK} = 10\text{ k}\Omega$	I_{RM}	H11C1, H11C2, H11C3			50	μA
	$V_{RM} = 400\text{ V}, T_A = 100^\circ\text{C}, I_F = 0\text{ mA}, R_{GK} = 10\text{ k}\Omega$		H11C4, H11C5, H11C6			150	

TRANSFER CHARACTERISTICS ($T_A = 25^\circ\text{C}$ Unless otherwise specified.)

Characteristics	Test Conditions	Symbol	Device	Min	Typ*	Max	Units
Input Current to Trigger	$V_{AK} = 50\text{ V}, R_{GK} = 10\text{ k}\Omega$	I_{FT}	H11C1, H11C2, H11C4, H11C5			20	mA
			H11C3, H11C6			30	
	$V_{AK} = 100\text{ V}, R_{GK} = 27\text{ k}\Omega$		H11C1, H11C2, H11C4, H11C5			11	
			H11C3, H11C6			14	
Coupled dv/dt, input to output (figure 8)		dv/dt	ALL	500			V/ μS

*Typical values at $T_A = 25^\circ\text{C}$

勝特力材料 886-3-5753170
 勝特力电子(上海) 86-21-34970699
 勝特力电子(深圳) 86-755-83298787
[Http://www.100y.com.tw](http://www.100y.com.tw)

H11C1

H11C2

H11C3

H11C4

H11C5

H11C6

ISOLATION CHARACTERISTICS

Characteristic	Test Conditions	Symbol	Min	Typ*	Max	Units
Isolation Voltage	(t = 1 min.) (note 1)	V_{ISO}	5300			V
Isolation Resistance	(note 1) ($V_{I-O} = 500$ VDC)	R_{ISO}	10^{11}			Ω
Isolation Capacitance	(note 1) (f = 1 MHz, $V_{I-O} = 0$)	C_{I-O}		0.8		pF

*Typical values at $T_A = 25^\circ\text{C}$

Note

1. For this test, LED pins 1 and 2 are common, and SCR pins 4, 5 and 6 are common.

勝特力材料 886-3-5753170
 勝特力电子(上海) 86-21-34970699
 勝特力电子(深圳) 86-755-83298787
[Http://www.100y.com.tw](http://www.100y.com.tw)

H11C1 H11C2 H11C3 H11C4 H11C5 H11C6

Figure 1. LED Forward Current vs. Forward Voltage

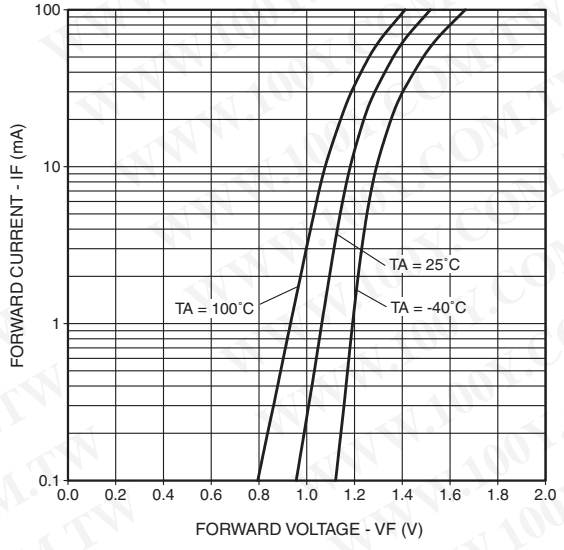

Figure 2. Trigger Current vs. Anode-Cathode Voltage

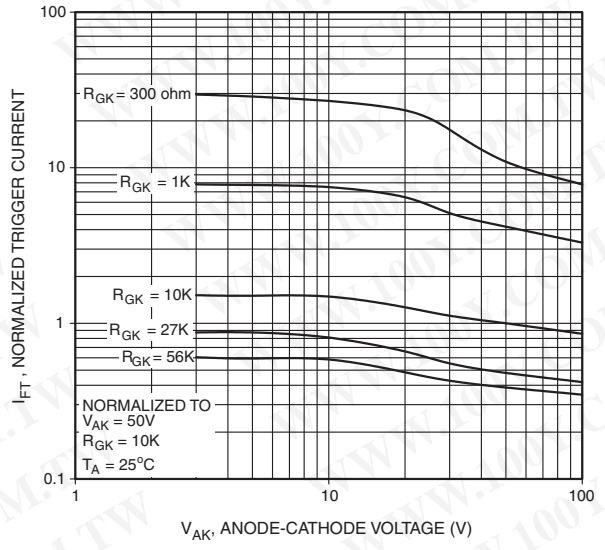

Figure 3. Input Trigger Current vs. Temperature

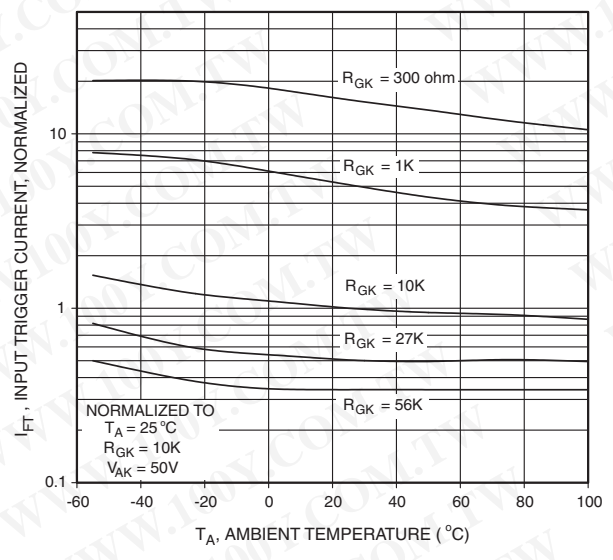
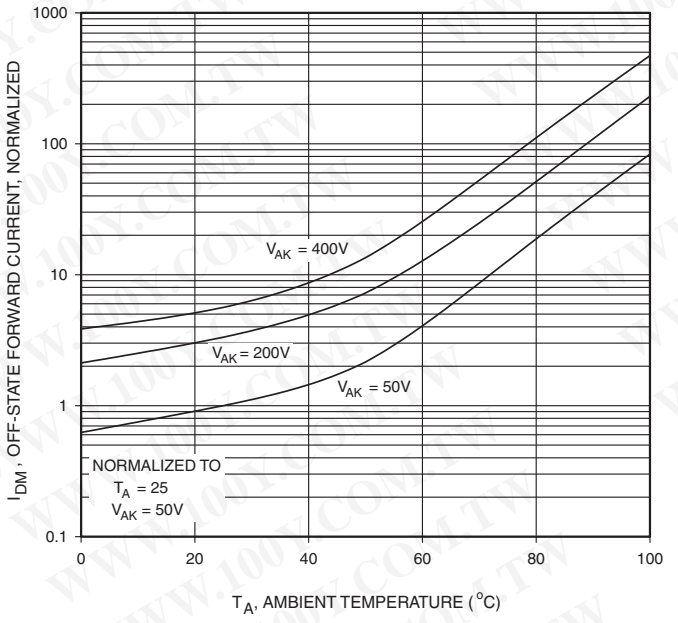

Figure 4. Off-State Current vs. Temperature



H11C1

H11C2

H11C3

H11C4

H11C5

H11C6

Figure 5. Forward Blocking Voltage, V_{DM} vs. Temperature

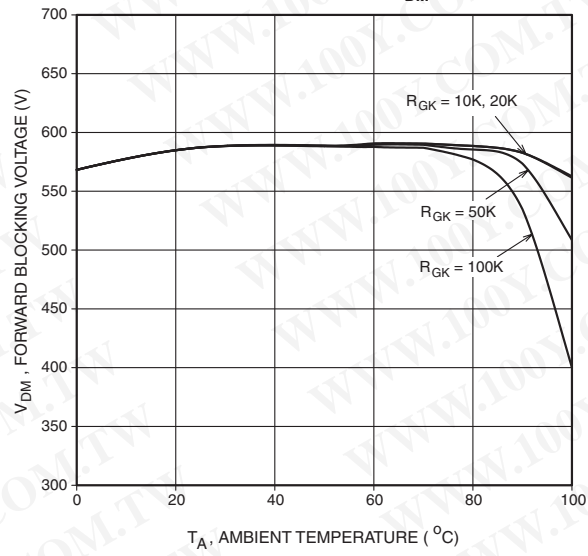
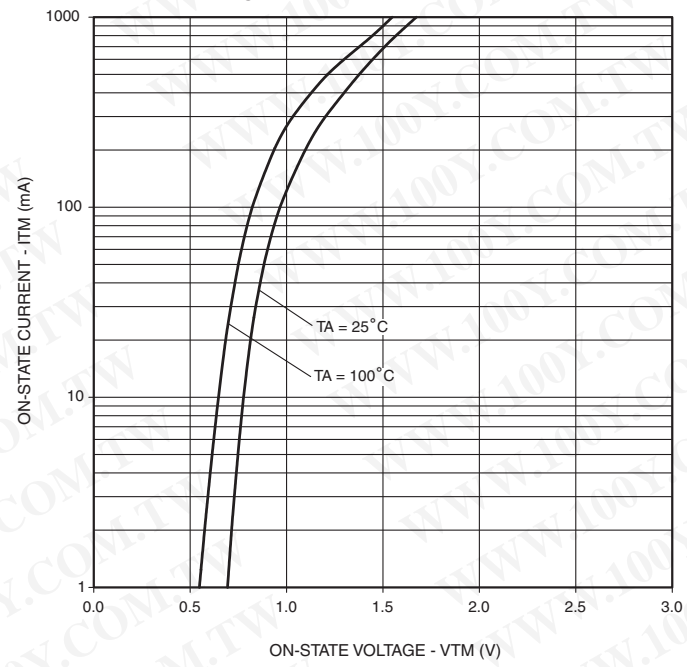
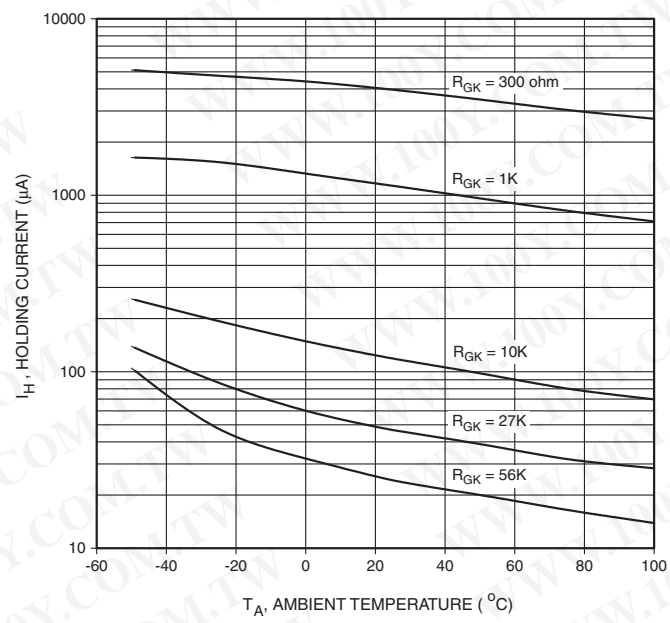

Figure 6. On-State Characteristics



勝特力材料 886-3-5753170
 勝特力电子(上海) 86-21-34970699
 勝特力电子(深圳) 86-755-83298787
[Http://www.100y.com.tw](http://www.100y.com.tw)

Figure 7. Holding Current, I_H vs. Temperature



H11C1

H11C2

H11C3

H11C4

H11C5

H11C6

TYPICAL APPLICATIONS

10A, T²L COMPATIBLE, SOLID STATE RELAY

Use of the H11C4 for high sensitivity, 5300 V isolation capability, provides this highly reliable solid state relay design. This design is compatible with 74, 74S and 74H series T²L logic systems inputs and 120V AC (H11C1, H11C2, H11C3) or 220V AC (H11C4, H11C5, H11C6) loads up to 10A.

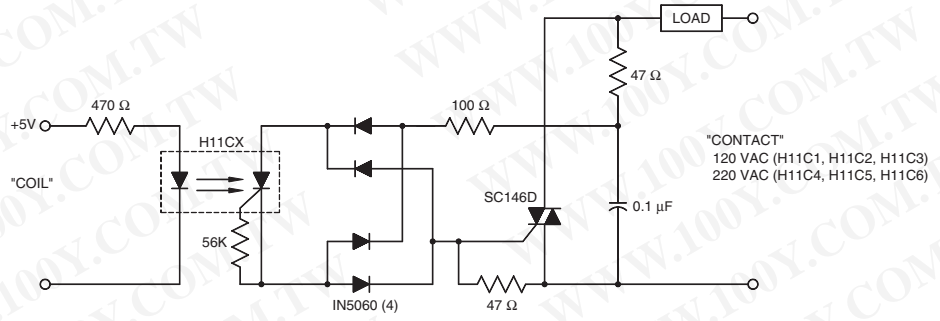

25W, LOGIC INDICATOR LAMP DRIVER

The high surge capability and non-reactive input characteristics of the H11C allow it to directly couple, without buffers, T²L and DTL logic to indicator alarm devices, without danger of introducing noise and logic glitches.

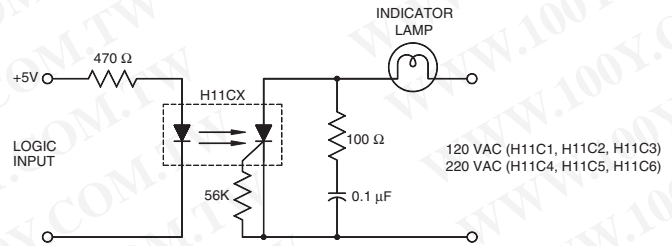

200V/400V SYMMETRICAL TRANSISTOR COUPLER

Use of the high voltage PNP portion of the H11C provides a 400V transistor capable of conducting positive and negative signals with current transfer ratios of over 1%. This function is useful in remote instrumentation, high voltage power supplies and test equipment. Care should be taken not to exceed the H11C 400mW power dissipation rating when used at high voltages.

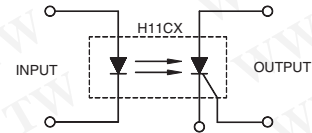

勝特力材料 886-3-5753170
 胜特力电子(上海) 86-21-34970699
 胜特力电子(深圳) 86-755-83298787
[Http://www.100y.com.tw](http://www.100y.com.tw)

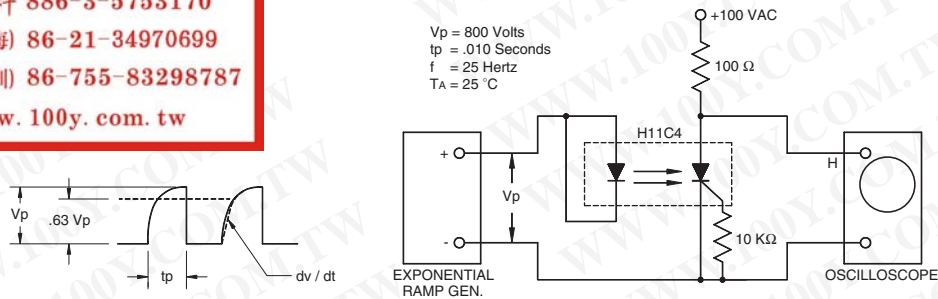

Fig. 8 Coupled dv/dt - Test Circuit

H11C1

H11C2

H11C3

H11C4

H11C5

H11C6

ORDERING INFORMATION

Option	Order Entry Identifier	Description
S	.S	Surface Mount Lead Bend
SD	.SD	Surface Mount; Tape and Reel
W	.W	0.4" Lead Spacing
300	.300	VDE 0884
300W	.300W	VDE 0884, 0.4" Lead Spacing
3S	.3S	VDE 0884, Surface Mount
3SD	.3SD	VDE 0884, Surface Mount, Tape and Reel

Carrier Tape Specifications

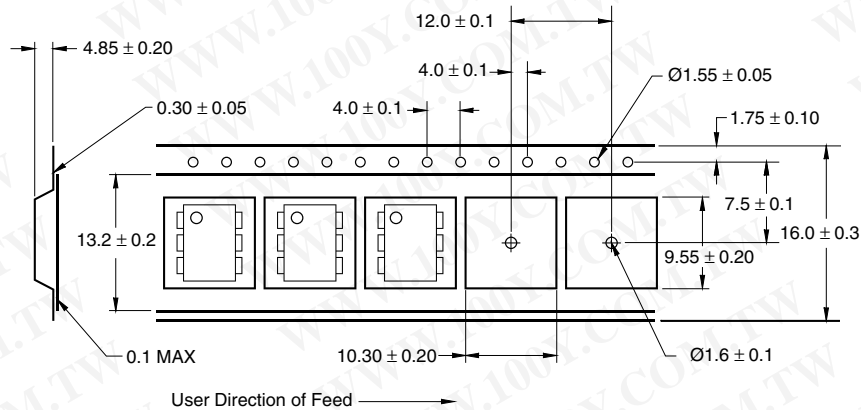

NOTE

All dimensions are in inches (millimeters)

勝特力材料 886-3-5753170
 勝特力电子(上海) 86-21-34970699
 勝特力电子(深圳) 86-755-83298787
[Http://www.100y.com.tw](http://www.100y.com.tw)

H11C1

H11C2

H11C3

H11C4

H11C5

H11C6

DISCLAIMER

FAIRCHILD SEMICONDUCTOR RESERVES THE RIGHT TO MAKE CHANGES WITHOUT FURTHER NOTICE TO ANY PRODUCTS HEREIN TO IMPROVE RELIABILITY, FUNCTION OR DESIGN. FAIRCHILD DOES NOT ASSUME ANY LIABILITY ARISING OUT OF THE APPLICATION OR USE OF ANY PRODUCT OR CIRCUIT DESCRIBED HEREIN; NEITHER DOES IT CONVEY ANY LICENSE UNDER ITS PATENT RIGHTS, NOR THE RIGHTS OF OTHERS.

LIFE SUPPORT POLICY

FAIRCHILD'S PRODUCTS ARE NOT AUTHORIZED FOR USE AS CRITICAL COMPONENTS IN LIFE SUPPORT DEVICES OR SYSTEMS WITHOUT THE EXPRESS WRITTEN APPROVAL OF THE PRESIDENT OF FAIRCHILD SEMICONDUCTOR CORPORATION. As used herein:

1. Life support devices or systems are devices or systems which, (a) are intended for surgical implant into the body, or (b) support or sustain life, and (c) whose failure to perform when properly used in accordance with instructions for use provided in the labeling, can be reasonably expected to result in a significant injury of the user.
2. A critical component in any component of a life support device or system whose failure to perform can be reasonably expected to cause the failure of the life support device or system, or to affect its safety or effectiveness.

勝特力材料 886-3-5753170
勝特力电子(上海) 86-21-34970699
勝特力电子(深圳) 86-755-83298787
[Http://www.100y.com.tw](http://www.100y.com.tw)