

# AlGaInP Visible Laser Diode ADL-66502TL

## ★ 660nm 50mW 60°C Reliable High Power Operation

### • Features

1. Highly reliable / COD free
2. Higher power
3. High efficiency

### • Applications

1. High power Laser modules
2. Industrial laser markers / measuring instruments
3. Medical applications

### • Absolute maximum ratings

Parameter	Symbol	Condition	Rating	Unit
Light output power	$P_O$	CW	55	mW
Reverse voltage (LD)	$V_{RL}$	-	2	V
Reverse voltage (PD)	$V_{RD}$	-	30	V
Forward current (PD)	$I_{FD}$	-	10	mA
Case temperature	$T_C$	-	-10~+60	°C
Storage temperature	$T_S$	-	-40~+85	°C

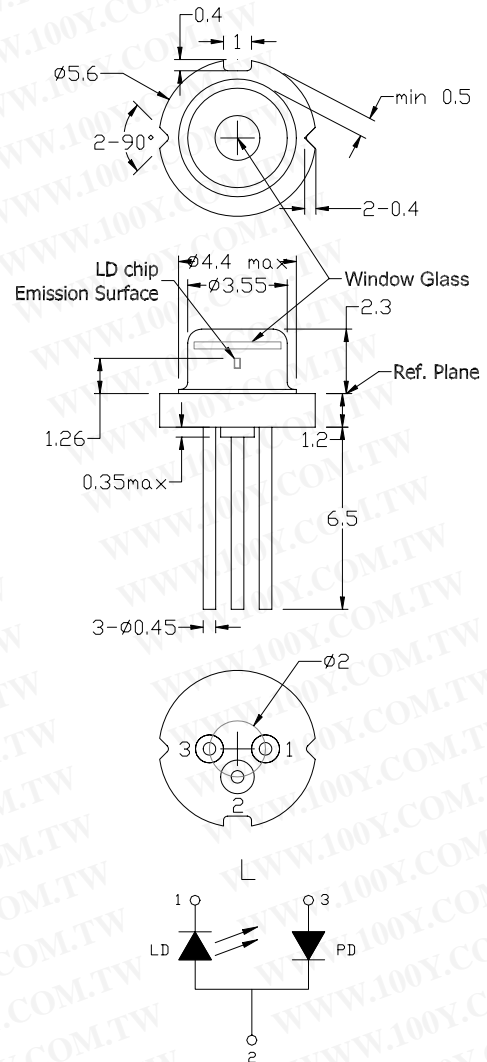

### • Electrical and optical characteristics ( $T_c=25^\circ\text{C}$ )

Parameter	Symbol	Min.	Typ.	Max.	Unit	Conditions
Peak wavelength	$\lambda$	645	660	665	nm	
Threshold current	$I_{th}$	30	40	50	mA	$P_o=50\text{mW CW}$
Operating current	$I_{op}$	-	90	120	mA	Kink free
Operating voltage	$V_{op}$	2.0	2.5	3.0	V	
Differential efficiency	$\eta$	0.7	1.0	1.4	mW/mA	$P_o=35\text{-}45\text{mW}$
Monitor current	$I_m$	0.05	0.15	0.5	mA	$P_o=50\text{mW}, V_{RD}=5\text{V}$
Parallel divergence angle	$\theta_{\parallel}$	7	9	12	deg	
Perpendicular divergence angle	$\theta_{\perp}$	17	19	22	deg	
Parallel FFP deviation angle	$\Delta\theta_{\parallel}$	-2	0	+2	deg	$P_o=50\text{mW}$
Perpendicular FFP deviation angle	$\Delta\theta_{\perp}$	-3	0	+3	deg	
Emission point accuracy	$\Delta x \Delta y \Delta z$	-80	0	+80	um	

### • Precautions

- \* Do not operate the device above maximum ratings. Doing so may cause unexpected and permanent damage to the device.
- \* Take precautions to avoid electrostatic discharge and/or momentary power spikes. A change in the characteristics of the laser or premature failure may result.
- \* Proper heat sinking of the device assures stability and lifetime. Always ensure that maximum operating temperatures are not exceeded.
- \* Observing visible or invisible laser beams with the human eye directly, or indirectly, can cause permanent damage. Use a camera to observe the laser.
- \* No laser device should be used in any application or situation where life or property is at risk in event of device failure.
- \* Specifications are subject to change without notice. Ensure that you have the latest specification by contacting us prior to purchase or use of the product.

# AlGaInP Visible Laser Diode

ADL-66502TL

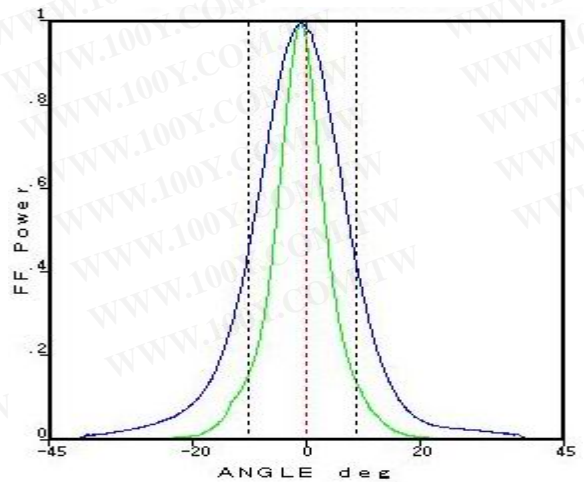
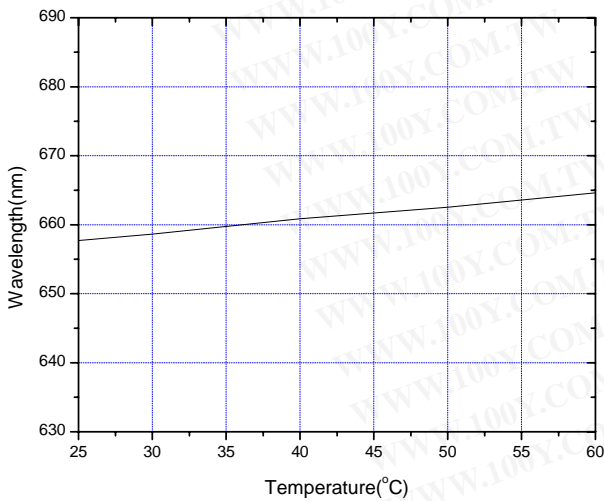
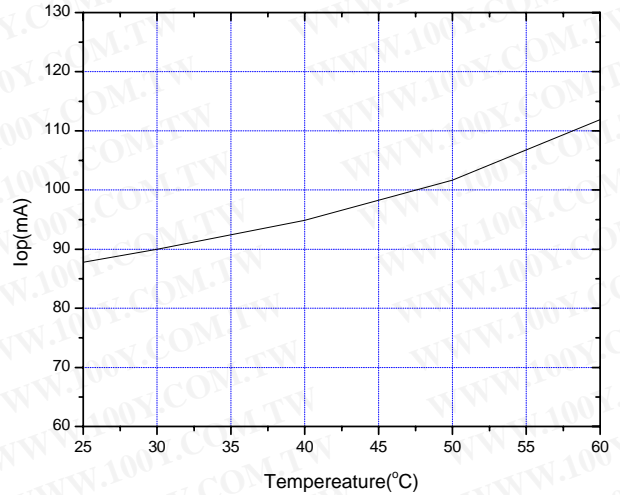
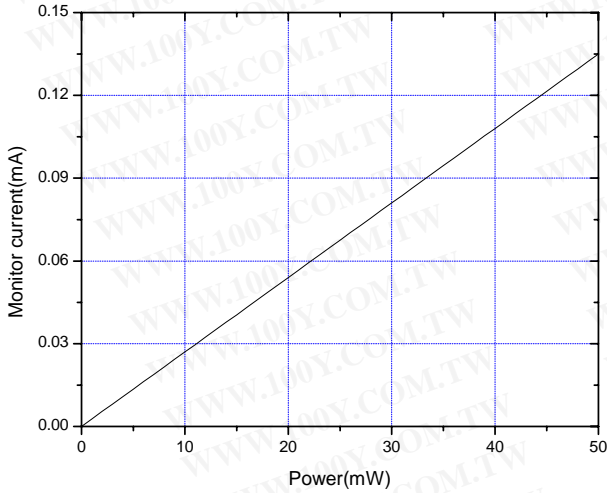
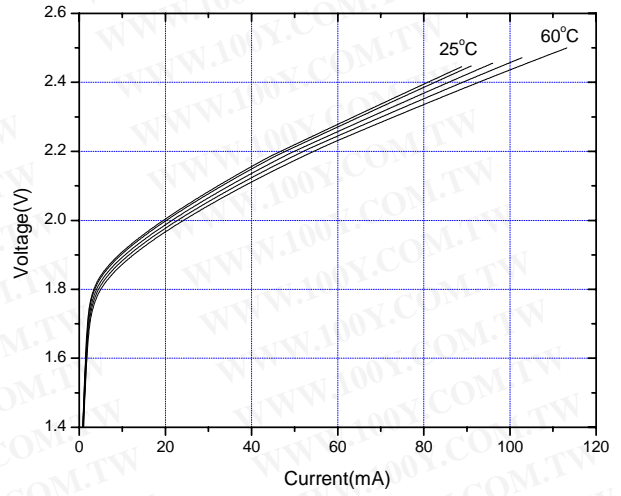
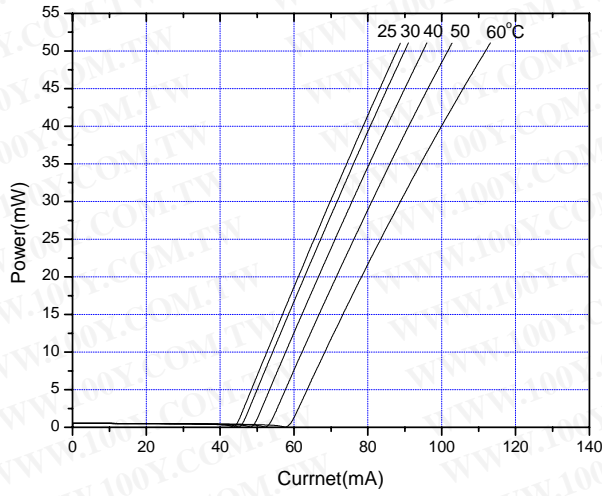

\* For reference only. Contents above are subject to change without notice.

勝特力材料 886-3-5753170  
勝特力电子(上海) 86-21-34970699  
勝特力电子(深圳) 86-755-83298787  
[Http://www.100y.com.tw](http://www.100y.com.tw)