

Incandescent reflector

Infrared heat lamps/healthcare



R95E E27



PAR38E E27

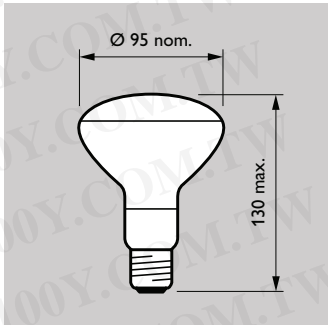

R95E E27

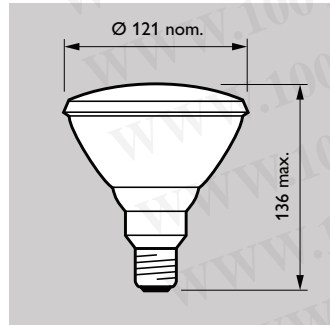

PAR38E E27

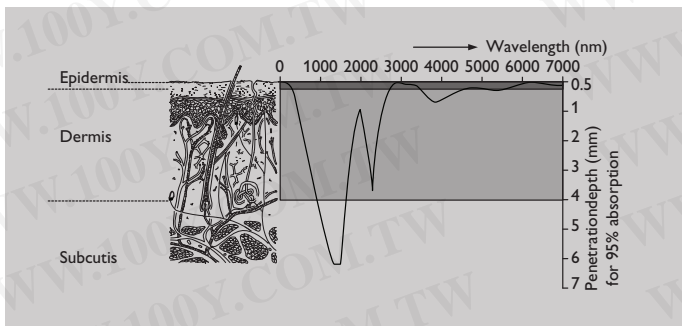

The penetration depth in the IR-A Region is optimal and becomes very low in the IR-B and IR-C. IR-C is already absorbed in the horny layer.

Features

- 90% of energy is transmitted as infrared
- Instant, accurately controllable radiant heat
- Special filament design for a concentrated beam
- High IR-A radiation level for deeper penetration of muscles and veins

Benefits

- Enhanced blood circulation relieves muscular pain
- Concentrated heat can be applied to where it is needed

Optimum heating economy and efficiency

Philips infrared lamps provide an excellent solution for localised heat treatment to provide relief from muscular pain.

They can also be used to treat ailments like lumbago, neuralgia and myalgia and colds.

This form of heat therapy has also been shown to speed the healing of different kinds of injuries, including sports injuries and non-infected wounds, and in many cases to provide rapid and effective pain relief.

The benefits of this form of heat therapy are based on a vasodilatory response in the skin which locally enhances the blood circulation.

This results in an increased metabolic rate and transport of metabolites and other essential biochemical compounds.

Benefits are also gained by deeper penetration of heat which provides a gentle and pleasant warming effect.

The effects of heating in the skin are related to the different layers of which the skin is composed, which have different light-absorbing characteristics.

The epidermis or outer part of the skin is itself made of two layers: the stratum corneum or horny layer; with a thickness of 8 - 20 μm, and the stratum malpighi, with a thickness of 50 - 150 μm.

Below the epidermis is the dermis, which varies in thickness between 1 and 4 mm.

All these layers have different refractive indices and different reflection, transmission and scattering characteristics, depending on the wavelength of the light.

Infrared radiation in the IR-B (medium infrared: 1.4 - 3 μm) and IR-C (long infrared: 3 μm - 1 mm) ranges is absorbed in the top layers of the skin. Because of the low thickness of these layers, the result is a relatively strong heating effect with a high temperature up to the pain threshold at approximately 45°C being reached rapidly.

The shorter-wavelength IR-A radiation (780 - 1400 nm) has a greater penetrating power: This means that the heat is dissipated in a larger skin volume, creating a more pleasant and diffuse warmth.

The Philips infrared heating lamps have a wavelength spectrum with a pronounced peak at approximately 1000 nm in the deep-penetrating IR-A range.

This radiation characteristic makes them ideal radiant heat sources for treating deeper-seated muscular ailments and sports injuries.

Choice of lamp types

Philips offers a choice of two infrared lamp types for use in heat radiation equipment in therapeutic applications: the R95 blown-bulb types with a 100W power rating, and the 150W PAR38 pressed glass reflector lamps.

For optimum directional control of the heat radiation, the PAR38 lamps have concentric rings in the front glass. All types have a red lacquered front to reduce visible light emission, thereby virtually eliminating disturbing glare.

The red filter also cuts off light below 600 nm to reduce radiation which would be absorbed by the blood haemoglobin (prevention of haemolysis). All types have a 300 hour lifetime at 100% output.

'Infraphil' lamps are intended specifically for use with heat radiation equipment marketed by Philips Domestic Appliances Division, while the Philips 'Infrared' lamps can be used with any suitable equipment.

All types have a universal burning position.

Applications

- Providing relief from muscular pain
- Providing relief from ailments such as rheumatism, lumbago, neuralgia, and colds
- Stimulating recovery from injury
- Comfort and cosmetic care

勝特力材料 886-3-5753170
 勝特力电子(上海) 86-21-34970699
 勝特力电子(深圳) 86-755-83298787
[Http://www.100y.com.tw](http://www.100y.com.tw)



PHILIPS

Incandescent reflector

Infrared heat lamps/healthcare

Type	Wattage W	Voltage V	Cap/ base	Finish	Lamp life 100% h	Nett weight g	Ordering number	EOC
PAR38 E INFRAPHIL								
INFRAPHIL PAR38E	150W	125-130V	E27	RED	300	308.00	9238 049 35600	128843
INFRAPHIL PAR38E	150W	230V	E27	RED	300	308.00	9238 049 44200	601032
INFRAPHIL PAR38E	150W	240V	E27	RED	300	308.00	9238 049 45500	128867
PAR38 E INFRARED								
INFRARED PAR38E	150W	230V	E27	RED	300	308.00	9238 066 44200	128874
R95 E INFRAPHIL								
INFRAPHIL R95E	100W	230V	E27	RED	300	53.50	9232 441 44200	136916
INFRAPHIL R95E	100W	240V	E27	RED	300	53.50	9232 441 45500	126771
R95 E INFRARED								
INFRARED R95E	100W	110-120V	E27	RED	300	53.50	9232 442 32200	149695
INFRARED R95E	100W	230V	E27	RED	300	53.50	9232 442 44200	145598

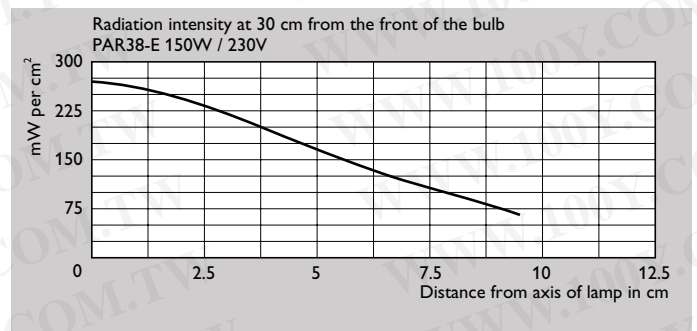
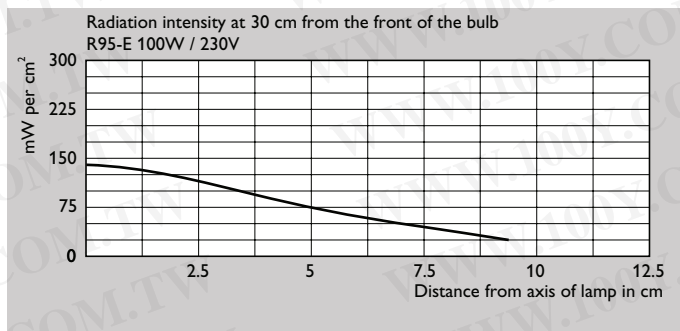

Radiation distributions

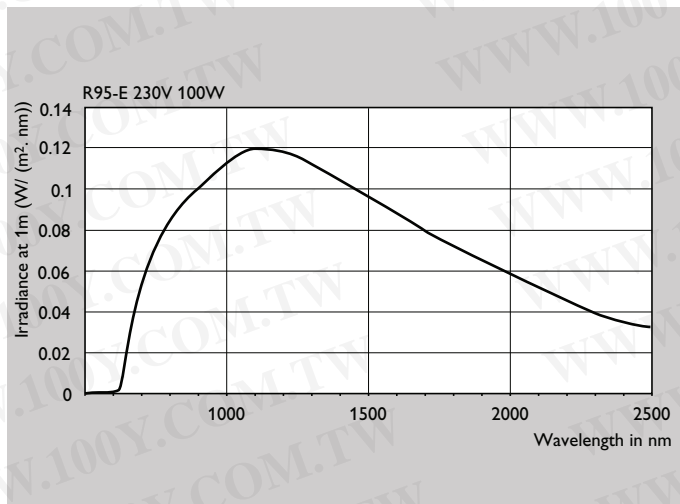

Spectral power distribution

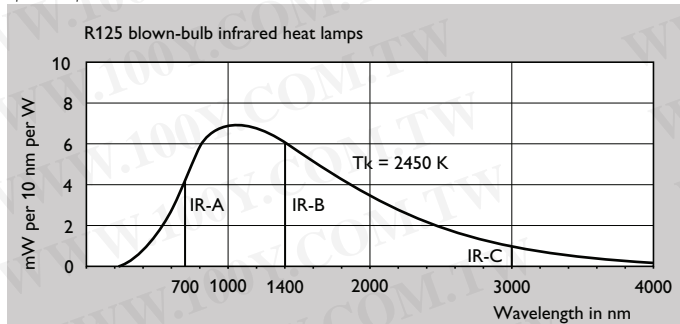

Spectral power distribution



勝特力材料 886-3-5753170
 勝特力电子(上海) 86-21-34970699
 勝特力电子(深圳) 86-755-83298787
[Http://www.100y.com.tw](http://www.100y.com.tw)



PHILIPS