

Bezeichnung



exkl. MwSt.  
Rabattgr. 70/W

Lampen für optische und lichtelektronische Zwecke, ohne Halogen, Niedervolt

8013	4050300206356	10 W	6	BA15d	46	25	-	1	100	37.10
8014	4050300206370	10 W	6	BA15s	46	25	-	1	100	47.70
8017	4050300017327	15 W	6	B15d	54	19	-	2	100	42.40
<b>8018</b>	<b>4050300206417</b>	<b>15 W</b>	<b>6</b>	<b>B15d</b>	<b>52</b>	<b>19</b>	<b>M/20</b>	<b>2</b>	<b>100</b>	<b>42.40</b>
8022	4050300206677	50 W	12	BA20d	69	35	-	3	100	42.40
8024	4050300013817	40 W	12	BA20d	67	35	-	4	100	37.10
8100	4050300342122	5 A	6	E14	65	35	F/74	5	100	31.80

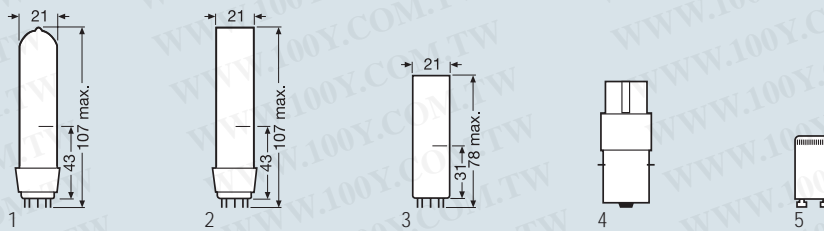

Bezeichnung



exkl. MwSt.  
Rabattgr. 71/X

Spektrallampen

Cd/10	4050300210353	Cadmium	15	1,0	15	Pico9	AC	1	0.46	450.00
Cs/10	4050300213842	Cesium	10	1,0	10	Pico9	AC	1	0.46	1220.00
He/10	4050300212258	Helium	55	1,0	60	Pico9	AC	1	0.46	930.00
Hg 100	4050300231310	Mercury	22...44	0,6...1	45	Pico9	AC/DC	2	0.46	390.00
HgCd/10	4050300211459	Mercury/Cadmium	25	1,0	30	Pico9	AC	1	0.46	360.00
K/10	4050300210377	Kalium	10	1,0	10	Pico9	AC	1	0.00	in Vorb.
Na/10	4050300210377	Sodium	15	1,0	15	Pico9	AC	1	0.46	420.00
Na 10 FL	4050300006925	Sodium	9	0,57	16	Pico9	AC	3	0.46	380.00
Ne/10	4050300212210	Neon	30	1,0	30	Pico9	AC	1	0.46	930.00
Rb/10	4050300213866	Rubidium	10	1,0	10	Pico9	AC	1	0.46	1220.00
Tl/10	4050300211435	Thalium	15	1,0	15	Pico9	AC	1	0.46	1220.00
Zn/10	4050300212234	Zinc	15	1,0	15	Pico9	AC	1	0.46	440.00
Accessories Starter	4050300839165	Starter St 191						5	0.00	4.00

**勝特力材料 886-3-5753170**  
**勝特力电子(上海) 86-21-54151736**  
**勝特力电子(深圳) 86-755-83298787**  
**Http://www.100y.com.tw**

# Socket IEC/EN 60061-1

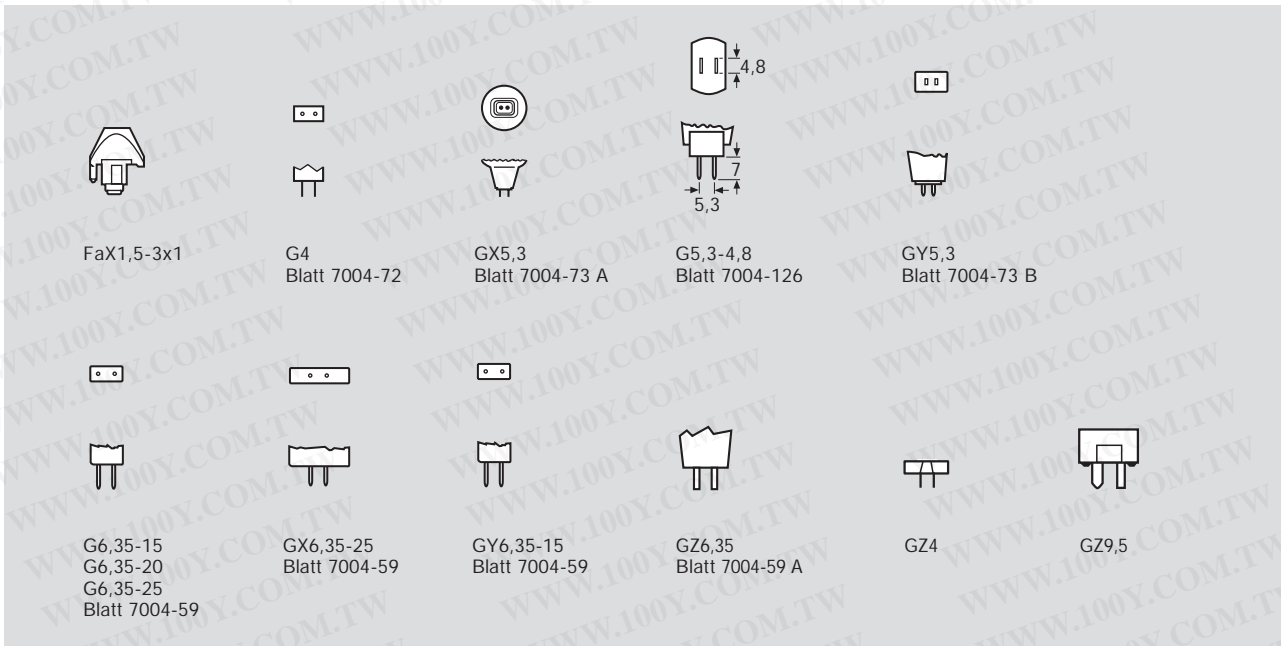
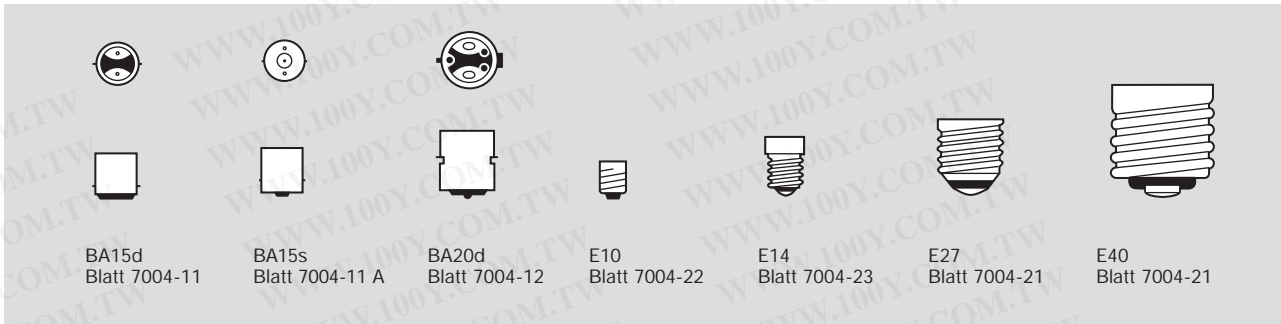

**勝特力材料 886-3-5753170**  
**勝特力电子(上海) 86-21-54151736**  
**勝特力电子(深圳) 86-755-83298787**  
[Http://www.100y.com.tw](http://www.100y.com.tw)

# Socket IEC/EN 60061-1

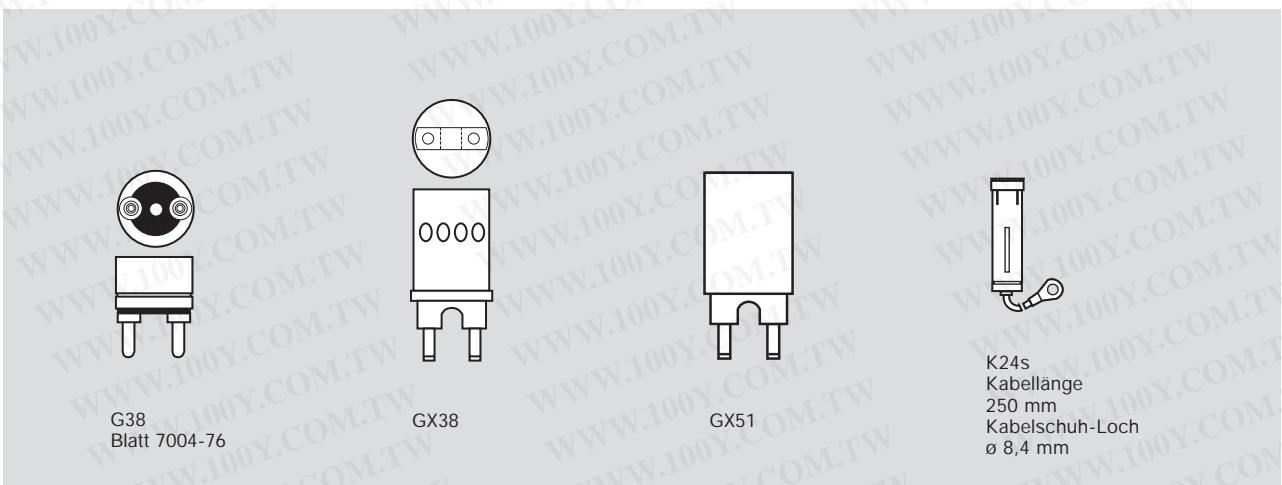
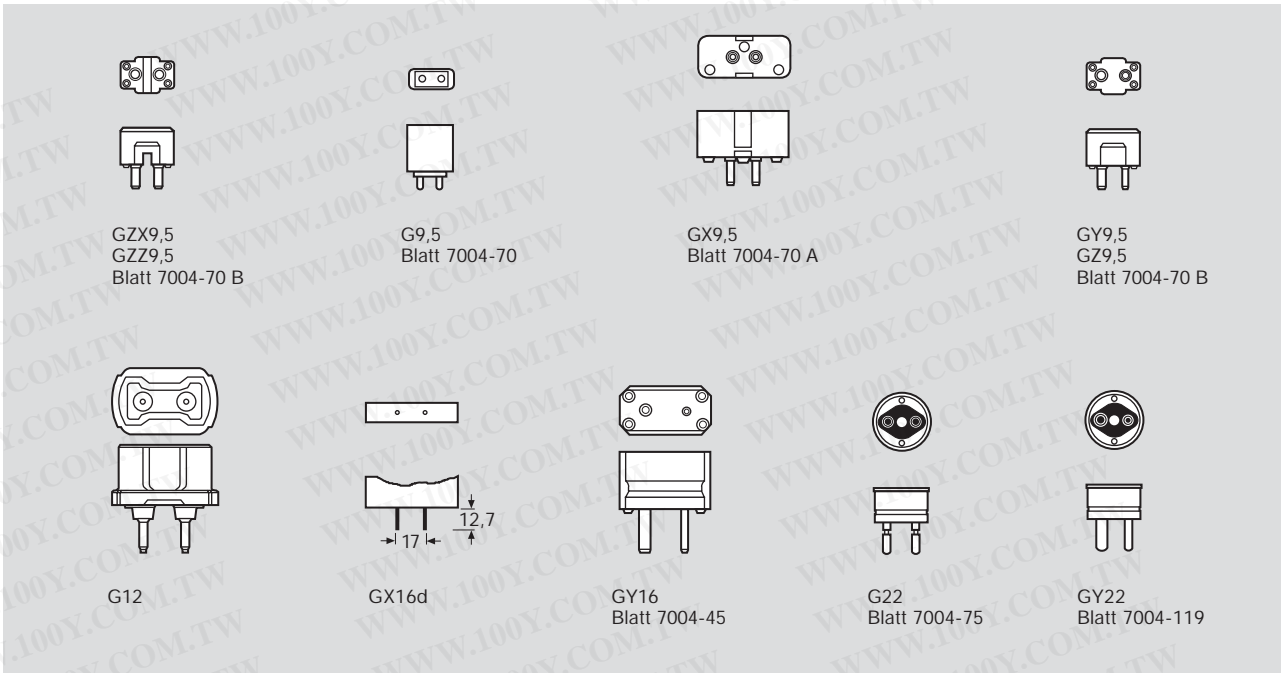

勝特力材料 886-3-5753170  
勝特力电子(上海) 86-21-54151736  
勝特力电子(深圳) 86-755-83298787  
[Http://www.100y.com.tw](http://www.100y.com.tw)

# Socket IEC/EN 60061-1



Pico9



P28s  
Blatt 7004-42



OXL



HPL

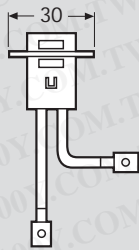

PK30d



R7s  
RX7s  
Blatt 7004-92 A



PG22-6,35  
Blatt 7004-48

勝特力材料 886-3-5753170  
勝特力电子(上海) 86-21-54151736  
勝特力电子(深圳) 86-755-83298787  
[Http://www.100y.com.tw](http://www.100y.com.tw)

# Socket

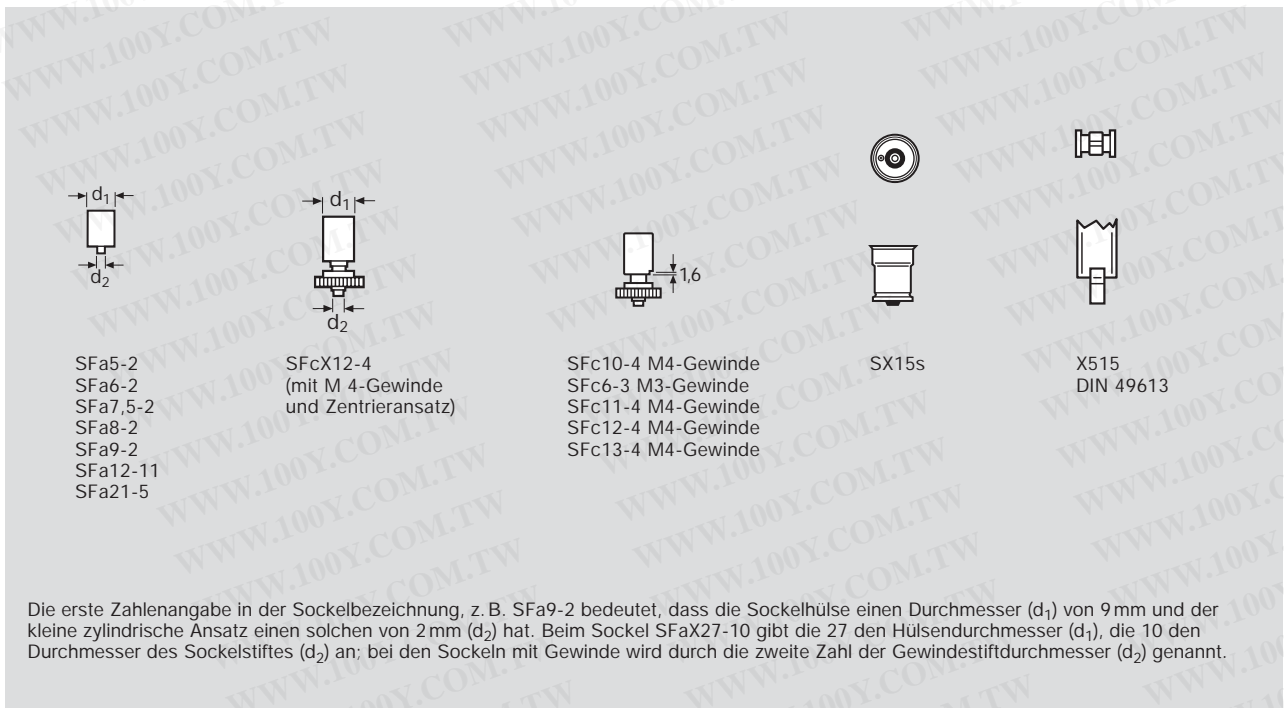
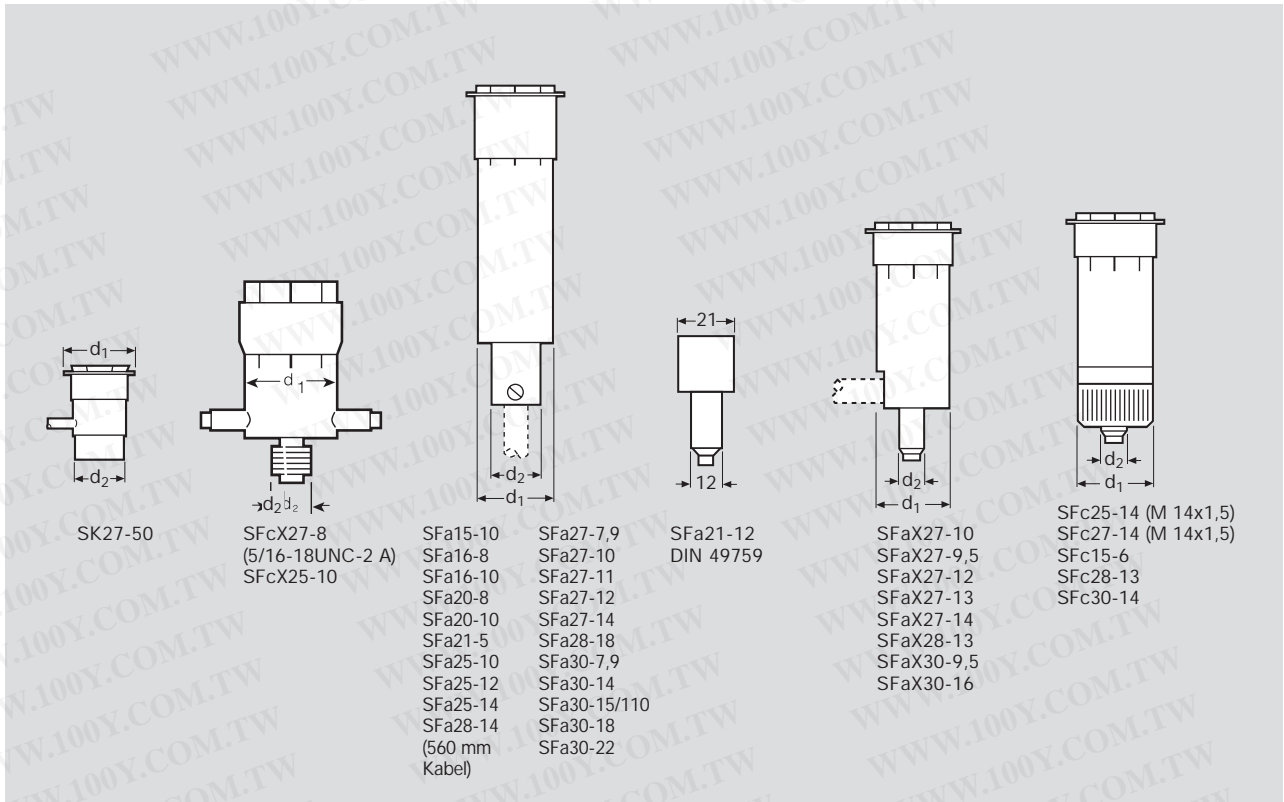

勝特力材料 886-3-5753170  
 勝特力电子(上海) 86-21-54151736  
 勝特力电子(深圳) 86-755-83298787  
[Http://www.100y.com.tw](http://www.100y.com.tw)

# Brennstellungen

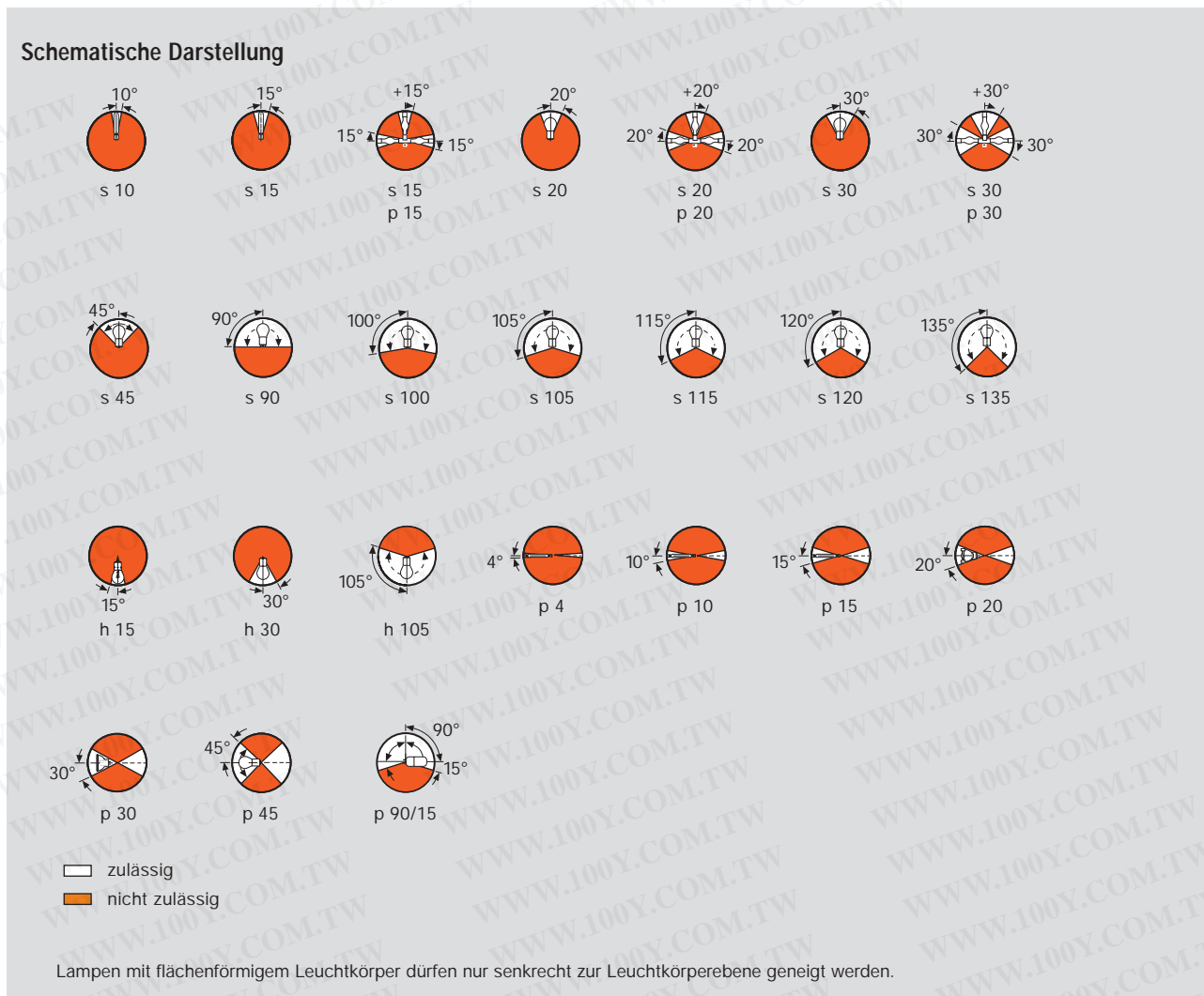

Eine Gewähr für die Lampen kann nur bei Verwendung von zugelassenen oder als geeignet erklärten Betriebsgeräten übernommen werden. Bezugsnachweis für Vorschalt- und Zündgeräte etc. auf Anfrage. Mit Ausnahme der Produktfamilie XBO® enthalten alle Entladungslampen in geringen Mengen umweltrelevante

Schadstoffe (z. B. Quecksilber) und müssen deshalb in Europa unter dem EWC-Code 06 04 04\*, quecksilberhaltige Abfälle, bzw. 20 01 21\*, Leuchtstoffröhren und andere quecksilberhaltige Abfälle, ordnungsgemäß entsorgt werden. In anderen Ländern müssen die jeweiligen nationalen Vorschriften beachtet werden.

**勝特力材料 886-3-5753170**  
**勝特力电子(上海) 86-21-54151736**  
**勝特力电子(深圳) 86-755-83298787**  
**Http://www.100y.com.tw**