

Contents

1
2
3
4
5
6
7
8
9
10
11
12
13
14
15
16

5SJ4 Branch Circuit Protectors



5SJ4 Page

Selection and ordering data

- 1-pole up to 63A 16/4

General data	16/3
Tripping characteristics	16/2
Dimension Drawings	16/23
Technical data	16/5

5SY4 Supplementary Protectors

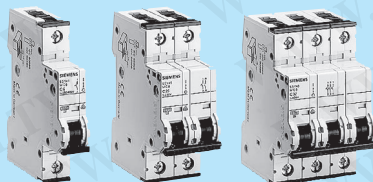

5SY4 Page

Selection and ordering data

- 1-pole, 1-pole+ N, and 2-pole up to 63A 16/8
- 3-pole, 3-pole + N, and 4-pole up to 63A 16/9
- Additional components 16/12
- Accessories 16/14

General data	16/6
Tripping characteristics	16/2
Dimension Drawings	16/23
Technical data	16/21

5SP Supplementary Protectors

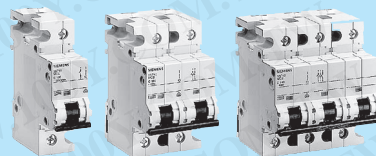

5SP4 Page

Selection and ordering data

- 1-pole, 2-pole, 3-pole and 4-pole up to 125A 16/10
- Additional components 16/12
- Accessories 16/15

General data	16/6
Tripping characteristics	16/2
Dimension Drawings	16/23
Technical data	16/21

AC/DC Product Range 5SY5 Supplementary Protectors

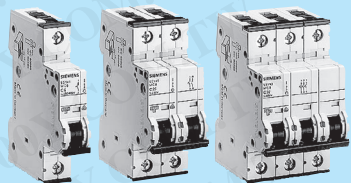

5SY5 Page

Selection and ordering data

- 1-pole and 2-pole up to 63A 16/11
- Additional components 16/12
- Accessories 16/14

General data	16/6
Tripping characteristics	16/2
Dimension Drawings	16/23
Technical data	16/21

5SX2 Supplementary Protectors



5SX2 Page

Selection and ordering data

- 1-pole and 2-pole up to 63A 16/16
- 3-pole up to 63A 16/17
- Additional components 16/18
- Accessories 16/19

General data	16/6
Tripping Characteristics	16/2
Dimension Drawings	16/23
Technical data	16/21

3NW7 Cylindrical Fuse Holders

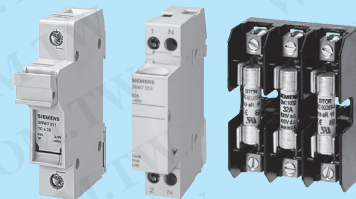

3NW7 and 3NC10 Page

Selection and ordering data

- 3NW7**
- 1-, 1+N, 2- and 3-, 3+N and 4-poles up to 100 A 16/25

- 3NC10**
- 1-, 2- & 3-pole up to 30 A 16/28

General data	16/24, 16/28
Dimension Drawings	16/27, 16/28
Technical Data	16/26, 16/28

Control Circuit Protection

General Data

Trip characteristics

Tripping characteristics acc. to EN 60 898

Tripping characteristic A, -5

Type A characteristic is designed to protect very sensitive circuits such as semiconductors. Magnetic trip point - 2 to 3 times I_n rating. Thermal trip point - 1.13 to 1.45 protector rating.

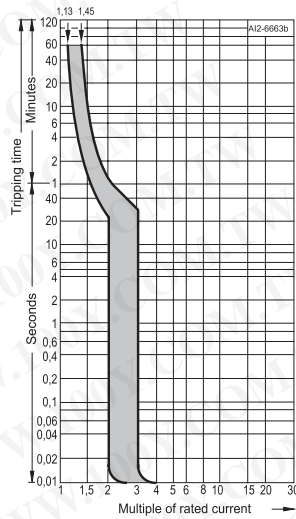

Tripping characteristic B, -6

Type B characteristic designed for European residential circuit protection. This characteristic can also be used for protection of computers and electronic equipment. Magnetic trip point - 3 to 5 times I_n rating. Thermal trip point - 1.13 to 1.45 protector rating.

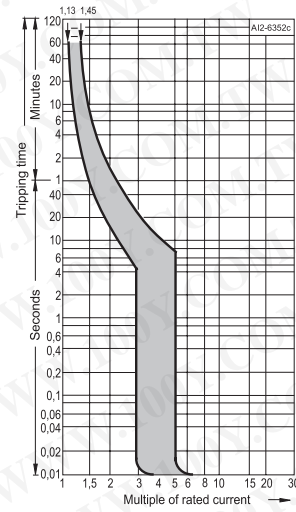

Tripping characteristic C, -7

Type C characteristic is for general device protection in control circuits. Magnetic trip point - 5 to 10 times I_n rating. Thermal trip point - 1.13 to 1.45 protector rating.

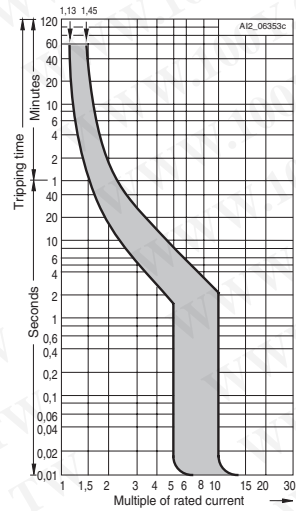

Tripping characteristic D, -8

Type D characteristic is designed for high inrush loads. Magnetic trip point - 10 to 20 times I_n rating. Thermal trip point - 1.13 to 1.45 protector rating.

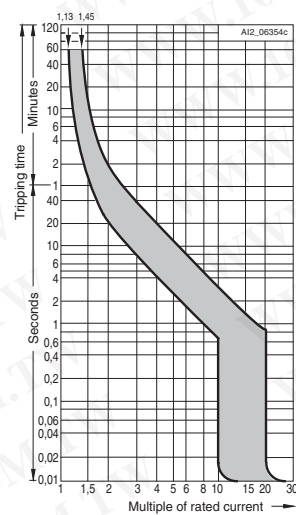

For different ambient temperatures, the current values of the delayed tripping operation change by approximately 5% per 10°K temperature difference. Specifically they increase for temperatures below 25°C (5SJ41), 30°C (5SP, 5SX, 5SY) and decrease for temperatures above 25°C (5SJ41), 30°C (5SP, 5SX, 5SY).

For DC voltages the maximum current values of the instantaneous tripping operation increase by a factor of 1.2.

If more than one electrical circuit is loaded in a series of miniature circuit breakers or supplementary protectors, the resulting increase in ambient temperature affects the characteristic curve. In this case an additional correction factor found in the following table must be used.

Number	1	2 - 3	4 - 6	> 7
Correction factor K	1.00	0.90	0.88	0.85

勝特力材料 886-3-5753170
 勝特力电子(上海) 86-21-34970699
 勝特力电子(深圳) 86-755-83298787
[Http://www.100y.com.tw](http://www.100y.com.tw)

Control Circuit Protection

General Data

5SJ41 Branch Circuit Protector

Features

- Can be applied in both NEMA and IEC environments; CE and UL
- UL Listed to UL 489 and cUL Listed to CSA 22.2 No. 5-02
- Suitable for branch circuit protection applications up to 240 AC (same phase) and 60 VDC
- HACR rated
- Wide current range availability — 0.3 to 63 A
- High rated breaking capacity of up to 14,000 A . 240 VAC: 10,000 A / 60 VDC
- Available with tripping characteristic B, C or D (see General Data)
- Same design as Siemens popular line of Supplementary Protectors (UL 1077)
- Identical screw terminals on line and load sides
- Visible indicator for ON and OFF/Trip

Applications

5SJ41 miniature circuit breakers are designed to comply with UL 489 and CSA 22.2 No. 5-02 standards. They are used in single pole, branch circuit protection applications up to 240 VAC maximum and 60 VDC maximum.

Always follow the National Electrical code as well as any other applicable local and/or industry codes when wiring your panel for applications within the United States.

Design

5SJ41 miniature circuit breakers are equipped with an inverse time trip element and an instantaneous electromagnetic release for high overload and short circuit currents.

勝特力材料 886-3-5753170
勝特力电子(上海) 86-21-34970699
勝特力电子(深圳) 86-755-83298787
[Http://www.100y.com.tw](http://www.100y.com.tw)

Control Circuit Protection

New 5SJ Branch Circuit Protector

勝特力材料 886-3-5753170
 勝特力电子(上海) 86-21-34970699
 勝特力电子(深圳) 86-755-83298787
[Http://www.100y.com.tw](http://www.100y.com.tw)

5SJ41 70 mm mounting depth

Features

All new 5SJ41 miniature circuit breakers are designed to comply with **UL489** and **CSA 22.2 No. 5-02** standards. They are used in single pole, branch circuit protection applications up to 240 VAC maximum and 60 VDC maximum. Refer to Technical Data (page 16/5) for additional information.

Selection and ordering data

I_n	Characteristic B		Characteristic C		Characteristic D	
	Order No.	List Price \$	Order No.	List Price \$	Order No.	List Price \$
A		1 item		1 item		1 item
1-pole						
0.3	—		5SJ4114-7HG40	58.00	5SJ4114-8HG40	58.00
0.5	—		5SJ4105-7HG40	58.00	5SJ4105-8HG40	58.00
1	—		5SJ4101-7HG40	58.00	5SJ4101-8HG40	58.00
1.6	—		5SJ4115-7HG40	58.00	5SJ4115-8HG40	58.00
2	—		5SJ4102-7HG40	58.00	5SJ4102-8HG40	58.00
3	—		5SJ4103-7HG40	58.00	5SJ4103-8HG40	58.00
4	—		5SJ4104-7HG40	58.00	5SJ4104-8HG40	58.00
5	—		5SJ4111-7HG40	58.00	5SJ4111-8HG40	58.00
6	5SJ4106-6HG40	58.00	5SJ4106-7HG40	58.00	5SJ4106-8HG40	58.00
8	—		5SJ4108-7HG40	58.00	5SJ4108-8HG40	58.00
10	5SJ4110-6HG40	58.00	5SJ4110-7HG40	58.00	5SJ4110-8HG40	58.00
13	5SJ4113-6HG40	58.00	5SJ4113-7HG40	58.00	5SJ4113-8HG40	58.00
15	5SJ4118-6HG40	58.00	5SJ4118-7HG40	58.00	5SJ4118-8HG40	58.00
16	5SJ4116-6HG40	58.00	5SJ4116-7HG40	58.00	5SJ4116-8HG40	58.00
20	5SJ4120-6HG40	58.00	5SJ4120-7HG40	58.00	5SJ4120-8HG40	58.00
25	5SJ4125-6HG40	58.00	5SJ4125-7HG40	58.00	5SJ4125-8HG40	58.00
30	5SJ4130-6HG40	58.00	5SJ4130-7HG40	58.00	5SJ4130-8HG40	58.00
32	5SJ4132-6HG40	58.00	5SJ4132-7HG40	58.00	5SJ4132-8HG40	58.00
35	5SJ4135-6HG40	62.00	5SJ4135-7HG40	62.00	5SJ4135-8HG40	62.00
40	5SJ4140-6HG40	62.00	5SJ4140-7HG40	62.00	5SJ4140-8HG40	62.00
45	5SJ4145-6HG40	64.00	5SJ4145-7HG40	64.00	5SJ4145-8HG40	64.00
50	5SJ4150-6HG40	66.00	5SJ4150-7HG40	66.00	5SJ4150-8HG40	66.00
60	5SJ4160-6HG40	70.00	5SJ4160-7HG40	70.00	5SJ4160-8HG40	70.00
63	5SJ4163-6HG40	70.00	5SJ4163-7HG40	70.00	5SJ4163-8HG40	70.00



1-pole



Technical Data

Specification	5SJ41 Mini-Breaker		
	B	C	D
Tripping characteristic	B	C	D
Number of poles	1		
Rated voltage (UL 489)	V AC: 240 max. V DC: 60 max.		
Operating voltage, min.	24 VAC/DC		
Rated current	6 to 63 A	0.3 to 63 A	0.3 to 63 A
Interrupting Rating (UL 489) AC: Max. RMS Symmetrical	V AC 240: 14 kA; V DC 60: 10 kA	V AC 240: 14 kA (0.3 - 40 A) V AC 240: 5 kA (45 - 63 A) V DC 60: 10 kA (0.3 - 63 A)	V AC 240: 14 kA (0.3 - 20 A) V AC 240: 5 kA (25 - 63 A) V DC 60: 10 kA (0.3 - 63 A)
Standards	UL 489, CSA 22.2 No. 5-02, IEC/EN 60 898		
Certifications	UL, cUL, File No. E 243414		
Degree of protection	IP 10 acc. to DIN EN 60 529; IP 40 when panel mounted		
Device depth	70 mm		
Mounting technique	Standard 35 mm DIN rail		
Terminals	Identical screw terminals on both line and load sides		
Terminal tightening torque	31 lbs. in. (3.5 Nm)		
Wire Size	14-4 AWG (1.5 - 25 mm ²) 60/75°C, Cu only		
Recommended Wire Strip Length	0.59 in. (15 mm)		
Mounting Position	As Required		
Ambient temperature	-13° to +113°F (-25° to +45°C) temporary: +131°F (+55°C); max. humidity: 95%		
Calibration temperature	25°C (77°F) acc. to UL 489 30°C (86°F) acc. to EN 60 898		
Storage temperature	-40° to +167°F (-40° to +75°C)		
Resistance to vibration	60 m/s ² at 10 Hz up to 150 Hz acc. to IEC 60 068-2-6		
Dimensions	see catalog page 16/23		

Control Circuit Protection

General Data

5SX, 5SY and 5SP supplementary protectors

勝特力材料 886-3-5753170
 勝特力电子(上海) 86-21-34970699
 勝特力电子(深圳) 86-755-83298787
[Http://www.100y.com.tw](http://www.100y.com.tw)

Application

Siemens' UL 1077 Supplementary Protectors are designed to provide additional protection along with a branch circuit protection device. Since our Supplementary protectors are made to trip faster than a standard UL 489 Circuit Breaker they are able to provide additional protection for more sensitive devices inside the panel. Supplementary protectors can be used in a number of industrial applications such as to provide selectivity for multiple motor control circuits on the secondary side of a control transformer or power supply by allowing the user to quickly find the problem circuit should a fault occur without having to shut down all of the other control circuits. Supplementary protectors may also be used as a local disconnecting means inside the panel when a branch circuit protection device is already present.

Always remember to follow the National Electric Code when wiring your panel for applications within the United States.

Design

Supplementary protectors are equipped with a delayed overload/time-dependent thermal release (thermal bimetal) for low overcurrents and with an instantaneous electromagnetic release for high overload and short-circuit currents.

The special contact materials used guarantee a long service life and offer a high degree of protection against contact welding.

Mode of operation

Thanks to the extremely fast contact separation in cases of failures and the rapid quenching of the arc consequently generated in the arcing chamber, supplementary protectors assure a safe and current-limiting off-switching.

The permissible limit- I^2t -values of the energy limitation class 3 specified in EN 60 898 are generally undercut. This guarantees an excellent selectivity towards upstream overcurrent protection devices.

Features

- High rated breaking capacity of up to 10,000 A acc. to EN 60 898 / up to 15 kA acc. to EN 60 947-2
- Excellent current limiting and selectivity characteristics
- Tripping characteristic A, B, C and D
- Terminals offer protection against contact with fingers or the back of the hand acc. to the German accident prevention regulations VBG 4/ BGV A2
- Combined terminals enable a simultaneous connection of busbars and feeder cables
- Uniform components that can be quickly mounted individually, thanks to their snap-on technique
- The handle locking device effectively prevents any unauthorized operation of the handle

Features of 5SY

- Rapid connection of the feeder cable in front of the busbar
- Identical terminals at both sides for an optional infeed from the top or the bottom
- No tool required for mounting or dismounting
- Supports a fast and comfortable removal from the assembly
- Separate switch position indication

Features of 5SP4

- Disconnection characteristics acc. to EN 60947-3 (DIN VDE 0660 Part 107)
- Main switch characteristics acc. to EN 60 204-1
- Can be screwed onto bases
- Separate switch position indication

Device markings

5SY Front Markings

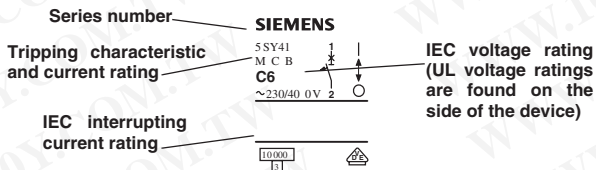

5SY side markings

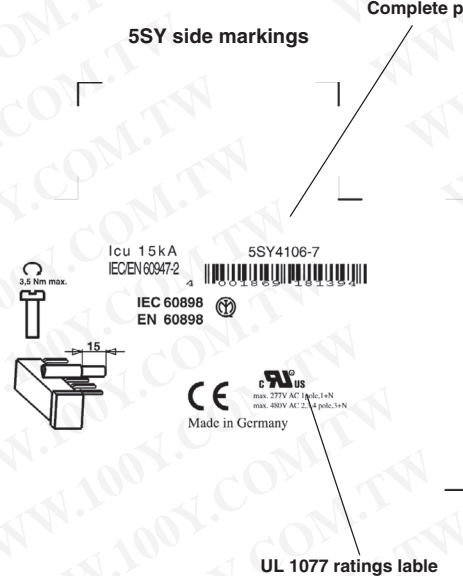

Overview

Features of 5SY supplementary protectors

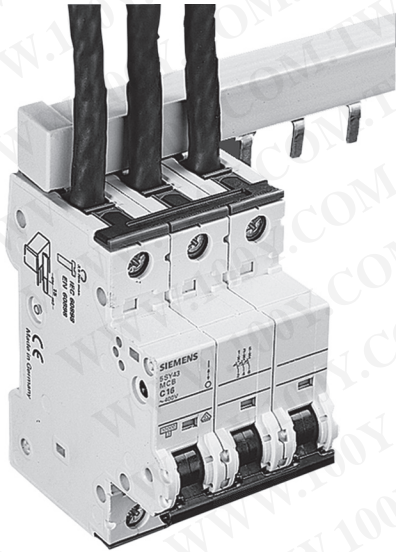

Easier, faster, enlarged wiring space

- Identical top and bottom terminals
- Connection of incoming cables vis-à-vis of the busbar
- Enlarged and easily accessible wiring space for the feeder cables
- Comfortable insertion of the incoming cables into the terminal
- Defined, visible and controllable connection of the feeder cables
- Universal infeed with top and bottom busbar mounting options.

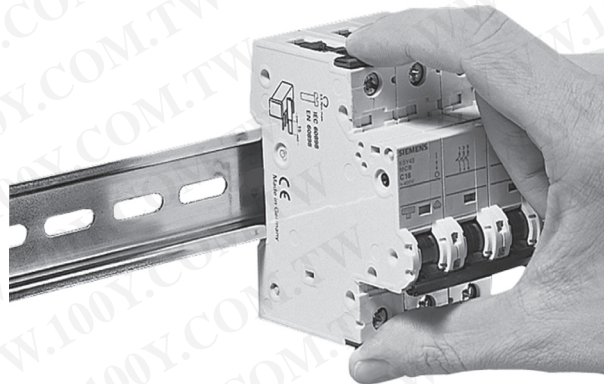

Flexible and no use of tools required

- Manually operable quick-assembly and disassembly systems requiring no use of tools
- Fast assembly and disassembly of the 5SY supplementary protectors to and from the standard mounting rail acc. to DIN EN 60175
- All devices can be easily and comfortably replaced at any time.

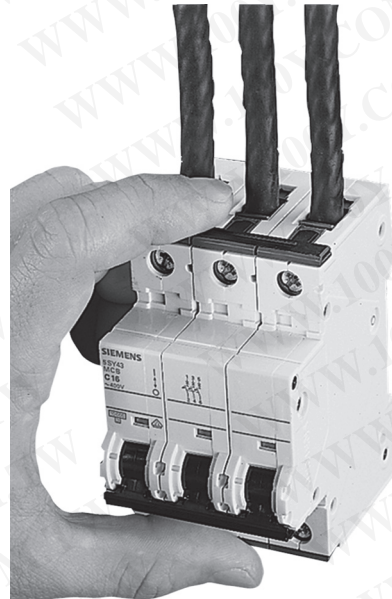

Protection against contact with clear advantages

- Integrated movable terminal covers located at the feeder cable input section
- The terminals are completely closed when screws are fully tightened
- Effective protection against contact, also when the device is fully grabbed

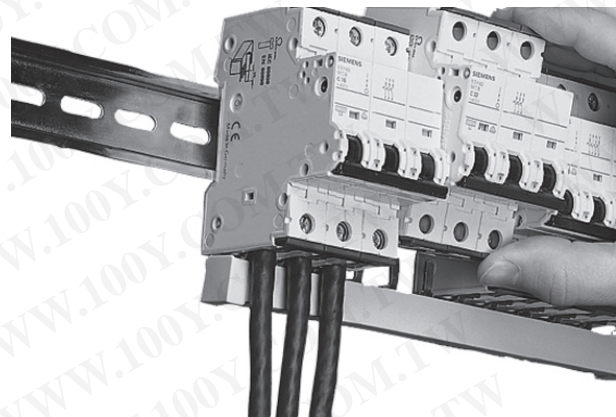

Removal from the assembly

Thanks to the combination of the various features stated above, 5SY supplementary protectors can be easily and rapidly removed from the assembly when circuits need to be changed - with these devices, removal of the busbar is no longer necessary.

Control Circuit Protection

5SY4 Supplementary Protectors



5SY4 70 mm mounting depth

勝特力材料 886-3-5753170
 勝特力电子(上海) 86-21-34970699
 勝特力电子(深圳) 86-755-83298787
[Http://www.100y.com.tw](http://www.100y.com.tw)

Features

All 5SY4 designs have been approved acc. to **UL 1077 and CSA 22.2 No. 235-M 89** and can therefore be used as "supplementary protectors" for applications of up to 277 V AC (1-pole and 1-pole + N designs) and 480 V AC (2-pole, 3-pole, 3-pole + N and 4-pole designs).



Selection and ordering data

	I_n	MW	Characteristic A		Characteristic B		Characteristic C		Characteristic D		Weight 1 item	Pack. unit
			Order No.	List Price \$	Order No.	List Price \$	Order No.	List Price \$	Order No.	List Price \$		
1-pole												
	A			1 item		1 item		1 item		1 item		
	0.3	1	—	—	—	—	5SY4 114-7	58.00	5SY4 114-8	58.00	0.165	12
	0.5		—	—	—	—	5SY4 105-7	58.00	5SY4 105-8	58.00		
	1		5SY4 101-5	58.00	—	—	5SY4 101-7	58.00	5SY4 101-8	58.00		
	1.6		5SY4 115-5	58.00	—	—	5SY4 115-7	58.00	5SY4 115-8	58.00		
	2		5SY4 102-5	58.00	—	—	5SY4 102-7	58.00	5SY4 102-8	58.00		
	3		5SY4 103-5	58.00	—	—	5SY4 103-7	58.00	5SY4 103-8	58.00		
	4		5SY4 104-5	58.00	—	—	5SY4 104-7	58.00	5SY4 104-8	58.00		
	5		—	—	—	—	5SY4 111-7	58.00	—	—		
	6		5SY4 106-5	58.00	5SY4 106-6	58.00	5SY4 106-7	58.00	5SY4 106-8	58.00		
	8		5SY4 108-5	58.00	—	—	5SY4 108-7	58.00	5SY4 108-8	58.00		
	10		5SY4 110-5	58.00	5SY4 110-6	58.00	5SY4 110-7	58.00	5SY4 110-8	58.00		
	13		5SY4 113-5	58.00	5SY4 113-6	58.00	5SY4 113-7	58.00	5SY4 113-8	58.00		
	15		—	—	—	—	5SY4 118-7	58.00	—	—		
	16		5SY4 116-5	58.00	5SY4 116-6	58.00	5SY4 116-7	58.00	5SY4 116-8	58.00		
	20		5SY4 120-5	58.00	5SY4 120-6	58.00	5SY4 120-7	58.00	5SY4 120-8	58.00		
	25		5SY4 125-5	58.00	5SY4 125-6	58.00	5SY4 125-7	58.00	5SY4 125-8	58.00		
	30		—	—	—	—	5SY4 130-7	58.00	—	—		
	32		5SY4 132-5	58.00	5SY4 132-6	58.00	5SY4 132-7	58.00	5SY4 132-8	58.00		
35		—	—	—	—	5SY4 135-7	62.00	—	—			
40		5SY4 140-5	62.00	5SY4 140-6	62.00	5SY4 140-7	62.00	5SY4 140-8	62.00			
45		—	—	—	—	5SY4 145-7	64.00	—	—			
50		5SY4 150-5	66.00	5SY4 150-6	66.00	5SY4 150-7	66.00	5SY4 150-8	66.00			
60		—	—	—	—	5SY4 160-7	70.00	—	—			
63		5SY4 163-5	70.00	5SY4 163-6	70.00	5SY4 163-7	70.00	5SY4 163-8	70.00			
1-pole + N												
	0.3	2	—	—	—	—	5SY4 514-7	116.00	5SY4 514-8	116.00	0.330	6
	0.5		—	—	—	—	5SY4 505-7	116.00	5SY4 505-8	116.00		
	1		5SY4 501-5	116.00	—	—	5SY4 501-7	116.00	5SY4 501-8	116.00		
	1.6		5SY4 515-5	116.00	—	—	5SY4 515-7	116.00	5SY4 515-8	116.00		
	2		5SY4 502-5	116.00	—	—	5SY4 502-7	116.00	5SY4 502-8	116.00		
	3		5SY4 503-5	116.00	—	—	5SY4 503-7	116.00	5SY4 503-8	116.00		
	4		5SY4 504-5	116.00	—	—	5SY4 504-7	116.00	5SY4 504-8	116.00		
	6		5SY4 506-5	116.00	5SY4 506-6	116.00	5SY4 506-7	116.00	5SY4 506-8	116.00		
	8		5SY4 508-5	116.00	—	—	5SY4 508-7	116.00	5SY4 508-8	116.00		
	10		5SY4 510-5	116.00	5SY4 510-6	136.00	5SY4 510-7	116.00	5SY4 510-8	116.00		
	13		5SY4 513-5	116.00	5SY4 513-6	136.00	5SY4 513-7	116.00	5SY4 513-8	116.00		
	16		5SY4 516-5	116.00	5SY4 516-6	136.00	5SY4 516-7	116.00	5SY4 516-8	116.00		
	20		5SY4 520-5	116.00	5SY4 520-6	136.00	5SY4 520-7	116.00	5SY4 520-8	116.00		
	25		5SY4 525-5	116.00	5SY4 525-6	116.00	5SY4 525-7	116.00	5SY4 525-8	116.00		
	32		5SY4 532-5	116.00	5SY4 532-6	116.00	5SY4 532-7	116.00	5SY4 532-8	116.00		
	40		5SY4 540-5	124.00	5SY4 540-6	124.00	5SY4 540-7	124.00	5SY4 540-8	124.00		
	50		5SY4 550-5	132.00	5SY4 550-6	132.00	5SY4 550-7	132.00	5SY4 550-8	132.00		
	63		5SY4 563-5	140.00	5SY4 563-6	140.00	5SY4 563-7	140.00	5SY4 563-8	140.00		
	2-pole											
	0.3	2	—	—	—	—	5SY4 214-7	133.00	5SY4 214-8	133.00	0.330	6
	0.5		—	—	—	—	5SY4 205-7	133.00	5SY4 205-8	133.00		
	1		5SY4 201-5	133.00	—	—	5SY4 201-7	133.00	5SY4 201-8	133.00		
	1.6		5SY4 215-5	133.00	—	—	5SY4 215-7	133.00	5SY4 215-8	133.00		
	2		5SY4 202-5	133.00	—	—	5SY4 202-7	133.00	5SY4 202-8	133.00		
	3		5SY4 203-5	133.00	—	—	5SY4 203-7	133.00	5SY4 203-8	133.00		
	4		5SY4 204-5	133.00	—	—	5SY4 204-7	133.00	5SY4 204-8	133.00		
	5		—	—	—	—	5SY4 211-7	133.00	—	—		
	6		5SY4 206-5	133.00	5SY4 206-6	133.00	5SY4 206-7	133.00	5SY4 206-8	133.00		
	8		5SY4 208-5	133.00	—	—	5SY4 208-7	133.00	5SY4 208-8	133.00		
	10		5SY4 210-5	133.00	5SY4 210-6	133.00	5SY4 210-7	133.00	5SY4 210-8	133.00		
	13		5SY4 213-5	133.00	5SY4 213-6	133.00	5SY4 213-7	133.00	5SY4 213-8	133.00		
	15		—	—	—	—	5SY4 218-7	133.00	—	—		
	16		5SY4 216-5	133.00	5SY4 216-6	133.00	5SY4 216-7	133.00	5SY4 216-8	133.00		
	20		5SY4 220-5	133.00	5SY4 220-6	133.00	5SY4 220-7	133.00	5SY4 220-8	133.00		
	25		5SY4 225-5	133.00	5SY4 225-6	133.00	5SY4 225-7	133.00	5SY4 225-8	133.00		
	30		—	—	—	—	5SY4 230-7	133.00	—	—		
	32		5SY4 232-5	133.00	5SY4 232-6	133.00	5SY4 232-7	133.00	5SY4 232-8	133.00		
	35		—	—	—	—	5SY4 235-7	141.00	—	—		
40		5SY4 240-5	141.00	5SY4 240-6	141.00	5SY4 240-7	141.00	5SY4 240-8	141.00			
45		—	—	—	—	5SY4 245-7	145.00	—	—			
50		5SY4 250-5	149.00	5SY4 250-6	149.00	5SY4 250-7	149.00	5SY4 250-8	149.00			
60		—	—	—	—	5SY4 260-7	157.00	—	—			
63		5SY4 263-5	157.00	5SY4 263-6	157.00	5SY4 263-7	157.00	5SY4 263-8	157.00			

1 MW = modular width of 18 mm
 Depth 70 mm = device mounting depth of 70 mm

Selection and ordering data

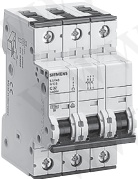
All 5SY4 designs have been approved acc. to **UL 1077 and CSA 22.2 No. 235-M 89** and can therefore be used as "supplementary protectors" for applications of up to 277 V AC (1-pole and 1-pole + N designs) and 480 V AC (2-pole, 3-pole, 3-pole + N and 4-pole designs).

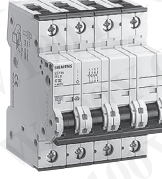
	I_n	MW	Characteristic A		Characteristic B		Characteristic C		Characteristic D		Weight 1 item	Pack. unit
			Order No.	List Price \$ 1 item	Order No.	List Price \$ 1 item	Order No.	List Price \$ 1 item	Order No.	List Price \$ 1 item		
3-pole												
	0.3	—	—	—	—	5SY4 314-7	191.00	5SY4 314-8	191.00	0.495	4	
	0.5	—	—	—	—	5SY4 305-7	191.00	5SY4 305-8	191.00			
	1	3	5SY4 301-5	191.00	—	191.00	5SY4 301-7	191.00	5SY4 301-8	191.00		
	1.6	—	5SY4 315-5	191.00	—	191.00	5SY4 315-7	191.00	5SY4 315-8	191.00		
	2	—	5SY4 302-5	191.00	—	191.00	5SY4 302-7	191.00	5SY4 302-8	191.00		
	3	—	5SY4 303-5	191.00	—	191.00	5SY4 303-7	191.00	5SY4 303-8	191.00		
	4	—	5SY4 304-5	191.00	—	191.00	5SY4 304-7	191.00	5SY4 304-8	191.00		
	5	—	—	—	—	—	5SY4 311-7	—	—	—		
	6	—	5SY4 306-5	191.00	5SY4 306-6	191.00	5SY4 306-7	191.00	5SY4 306-8	191.00		
	8	—	5SY4 308-5	191.00	—	—	5SY4 308-7	191.00	5SY4 308-8	191.00		
	10	—	5SY4 310-5	191.00	5SY4 310-6	191.00	5SY4 310-7	191.00	5SY4 310-8	191.00		
	13	—	5SY4 313-5	191.00	5SY4 313-6	191.00	5SY4 313-7	191.00	5SY4 313-8	191.00		
	15	—	—	—	—	—	5SY4 318-7	—	—	—		
	16	—	5SY4 316-5	191.00	5SY4 316-6	191.00	5SY4 316-7	191.00	5SY4 316-8	191.00		
	20	—	5SY4 320-5	191.00	5SY4 320-6	191.00	5SY4 320-7	191.00	5SY4 320-8	191.00		
	25	—	5SY4 325-5	191.00	5SY4 325-6	191.00	5SY4 325-7	191.00	5SY4 325-8	191.00		
30	—	—	—	—	—	5SY4 330-7	—	—	—			
32	—	5SY4 332-5	191.00	5SY4 332-6	191.00	5SY4 332-7	191.00	5SY4 332-8	191.00			
35	—	—	—	—	—	5SY4 335-7	203.00	—	—			
40	—	5SY4 340-5	203.00	5SY4 340-6	203.00	5SY4 340-7	203.00	5SY4 340-8	203.00			
45	—	—	—	—	—	5SY4 345-7	209.00	—	—			
50	—	5SY4 350-5	215.00	5SY4 350-6	215.00	5SY4 350-7	215.00	5SY4 350-8	215.00			
60	—	—	—	—	—	5SY4 360-7	227.00	—	—			
63	—	5SY4 363-5	227.00	5SY4 363-6	227.00	5SY4 363-7	227.00	5SY4 363-8	227.00			
3-pole + N												
	0.3	—	—	—	—	5SY4 614-7	276.00	5SY4 614-8	276.00	0.660	3	
	0.5	—	—	—	—	5SY4 605-7	276.00	5SY4 605-8	276.00			
	1	4	5SY4 601-5	276.00	—	—	5SY4 601-7	276.00	5SY4 601-8	276.00		
	1.6	—	5SY4 615-5	276.00	—	—	5SY4 615-7	276.00	5SY4 615-8	276.00		
	2	—	5SY4 602-5	276.00	—	—	5SY4 602-7	276.00	5SY4 602-8	276.00		
	3	—	5SY4 603-5	276.00	—	—	5SY4 603-7	276.00	5SY4 603-8	276.00		
	4	—	5SY4 604-5	276.00	—	—	5SY4 604-7	276.00	5SY4 604-8	276.00		
	6	—	5SY4 606-5	276.00	5SY4 606-6	276.00	5SY4 606-7	276.00	5SY4 606-8	276.00		
	8	—	5SY4 608-5	276.00	—	—	5SY4 608-7	276.00	5SY4 608-8	276.00		
	10	—	5SY4 610-5	276.00	5SY4 610-6	276.00	5SY4 610-7	276.00	5SY4 610-8	276.00		
	13	—	5SY4 613-5	276.00	5SY4 613-6	276.00	5SY4 613-7	276.00	5SY4 613-8	276.00		
	16	—	5SY4 616-5	276.00	5SY4 616-6	276.00	5SY4 616-7	276.00	5SY4 616-8	276.00		
	20	—	5SY4 620-5	276.00	5SY4 620-6	276.00	5SY4 620-7	276.00	5SY4 620-8	276.00		
	25	—	5SY4 625-5	276.00	5SY4 625-6	276.00	5SY4 625-7	276.00	5SY4 625-8	276.00		
	32	—	5SY4 632-5	276.00	5SY4 632-6	276.00	5SY4 632-7	276.00	5SY4 632-8	276.00		
	40	—	5SY4 640-5	292.00	5SY4 640-6	292.00	5SY4 640-7	292.00	5SY4 640-8	292.00		
50	—	5SY4 650-5	308.00	5SY4 650-6	308.00	5SY4 650-7	308.00	5SY4 650-8	308.00			
63	—	5SY4 663-5	324.00	5SY4 663-6	324.00	5SY4 663-7	324.00	5SY4 663-8	324.00			
4-pole												
	0.3	—	—	—	—	5SY4 414-7	301.00	5SY4 414-8	301.00	0.660	3	
	0.5	—	—	—	—	5SY4 405-7	301.00	5SY4 405-8	301.00			
	1	4	5SY4 401-5	301.00	—	—	5SY4 401-7	301.00	5SY4 401-8	301.00		
	1.6	—	5SY4 415-5	301.00	—	—	5SY4 415-7	301.00	5SY4 415-8	301.00		
	2	—	5SY4 402-5	301.00	—	—	5SY4 402-7	301.00	5SY4 402-8	301.00		
	3	—	5SY4 403-5	301.00	—	—	5SY4 403-7	301.00	5SY4 403-8	301.00		
	4	—	5SY4 404-5	301.00	—	—	5SY4 404-7	301.00	5SY4 404-8	301.00		
	6	—	5SY4 406-5	301.00	5SY4 406-6	301.00	5SY4 406-7	301.00	5SY4 406-8	301.00		
	8	—	5SY4 408-5	301.00	—	—	5SY4 408-7	301.00	5SY4 408-8	301.00		
	10	—	5SY4 410-5	301.00	5SY4 410-6	301.00	5SY4 410-7	301.00	5SY4 410-8	301.00		
	13	—	5SY4 413-5	301.00	5SY4 413-6	301.00	5SY4 413-7	301.00	5SY4 413-8	301.00		
	16	—	5SY4 416-5	301.00	5SY4 416-6	301.00	5SY4 416-7	301.00	5SY4 416-8	301.00		
	20	—	5SY4 420-5	301.00	5SY4 420-6	301.00	5SY4 420-7	301.00	5SY4 420-8	301.00		
	25	—	5SY4 425-5	301.00	5SY4 425-6	301.00	5SY4 425-7	301.00	5SY4 425-8	301.00		
	32	—	5SY4 432-5	301.00	5SY4 432-6	301.00	5SY4 432-7	301.00	5SY4 432-8	301.00		
	40	—	5SY4 440-5	317.00	5SY4 440-6	317.00	5SY4 440-7	317.00	5SY4 440-8	317.00		
50	—	5SY4 450-5	333.00	5SY4 450-6	333.00	5SY4 450-7	333.00	5SY4 450-8	333.00			
63	—	5SY4 463-5	349.00	5SY4 463-6	349.00	5SY4 463-7	349.00	5SY4 463-8	349.00			

1 MW = modular width of 18 mm
Depth 70 mm = device mounting

Control Circuit Protection Supplementary Protectors, High-Current Product Range

勝特力材料 886-3-5753170
 勝特力电子(上海) 86-21-34970699
 勝特力电子(深圳) 86-755-83298787
[Http://www.100y.com.tw](http://www.100y.com.tw)

5SP4 70 mm mounting depth

Features

All the new 5SP4 designs have been approved acc. to **UL 1077** and **CSA 22.2 No. 235-M 89** and can therefore be used as "supplementary protectors" for applications of up to 277 V AC (1-pole designs) and 480 V AC (2-pole, 3-pole, and 4-pole designs).

Selection and ordering data

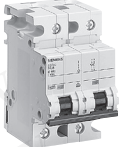
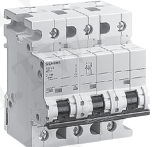
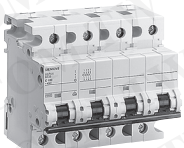

	I_n	MW	Characteristic B		Characteristic C		Characteristic D		Weight 1 item kg	Pack. unit Items
			Order No.	List Price \$ 1 item	Order No.	List Price \$ 1 item	Order No.	List Price \$ 1 item		
 <p>1-pole</p> <p>1 2</p>	80	1.5	5SP4 180-6	180.00	5SP4 180-7	180.00	5SP4 180-8	180.00	0.258	6
	100		5SP4 191-6	220.00	5SP4 191-7	180.00	5SP4 191-8	180.00		
	125		5SP4 192-6	265.00	5SP4 192-7	180.00	-	-		
 <p>2-pole</p> <p>1 3 2 4</p>	80	3	5SP4 280-6	440.00	5SP4 280-7	361.00	5SP4 280-8	361.00	0.516	3
	100		5SP4 291-6	485.00	5SP4 291-7	361.00	5SP4 291-8	361.00		
	125		5SP4 292-6	530.00	5SP4 292-7	661.00	-	-		
 <p>3-pole</p> <p>1 3 5 2 4 6</p>	80	4.5	5SP4 380-6	685.00	5SP4 380-7	541.00	5SP4 380-8	541.00	0.762	2
	100		5SP4 391-6	725.00	5SP4 391-7	541.00	5SP4 391-8	541.00		
	125		5SP4 392-6	770.00	5SP4 392-7	541.00	-	-		
 <p>4-pole</p> <p>1 3 5 7 2 4 6 8</p>	80	6	5SP4 480-6	860.00	5SP4 480-7	721.00	5SP4 480-8	721.00	1.032	1
	100		5SP4 491-6	950.00	5SP4 491-7	721.00	5SP4 491-8	721.00		
	125		5SP4 492-6	1179.00	5SP4 492-7	721.00	-	-		

1 MW = modular width of 27 mm
 Depth 70 mm = device mounting
 depth of 70 mm

Features

- U_n : 230/400 V, 50-60 Hz, 220 V DC per pole, applicable in networks up to: 250/440 V AC
 - 220 V DC: 1-pole
 - 440 V DC: 2-pole
- Standards: EN 60 898-1, DIN VDE 0641 Part 11, IEC 60 898
- Additional components can be retrofitted.
- **Devices do not comply with UL1077**

Selection and ordering data

	I_n	MW ¹⁾	Characteristic B		Characteristic C		Weight 1 item	Pack. unit	
			Order No.	List Price \$ 1 item	Order No.	List Price \$ 1 item			
1-pole									
									
		0.3	1	-		5SY5 114-7	98.00	0.147	12
		0.5		-		5SY5 105-7	98.00		
		1		-		5SY5 101-7	98.00		
		1.6		-		5SY5 115-7	98.00		
		2		-		5SY5 102-7	98.00		
		3		-		5SY5 103-7	98.00		
		4		-		5SY5 104-7	98.00		
		6		5SY5 106-6	98.00	5SY5 106-7	98.00		
		8		-		5SY5 108-7	98.00		
		10		5SY5 110-6	98.00	5SY5 110-7	98.00		
		13		5SY5 113-6	98.00	5SY5 113-7	98.00		
		16		5SY5 116-6	98.00	5SY5 116-7	98.00		
		20		5SY5 120-6	98.00	5SY5 120-7	98.00		
		25		5SY5 125-6	98.00	5SY5 125-7	98.00		
	32 ¹⁾		5SY5 132-6	98.00	5SY5 132-7	98.00			
	40		5SY5 140-6	114.00	5SY5 140-7	114.00			
	50		5SY5 150-6	130.00	5SY5 150-7	130.00			
	63		5SY5 163-6	146.00	5SY5 163-7	146.00			
2-pole									
									
		0.3	2	-		5SY5 214-7	196.00	0.304	6
		0.5		-		5SY5 205-7	196.00		
		1		-		5SY5 201-7	196.00		
		1.6		-		5SY5 215-7	196.00		
		2		-		5SY5 202-7	196.00		
		3		-		5SY5 203-7	196.00		
		4		-		5SY5 204-7	196.00		
		6		5SY5 206-6	196.00	5SY5 206-7	196.00		
		8		-		5SY5 208-7	196.00		
		10		5SY5 210-6	196.00	5SY5 210-7	196.00		
		13		5SY5 213-6	196.00	5SY5 213-7	196.00		
		16		5SY5 216-6	196.00	5SY5 216-7	196.00		
		20		5SY5 220-6	196.00	5SY5 220-7	196.00		
		25		5SY5 225-6	196.00	5SY5 225-7	196.00		
	32		5SY5 232-6	196.00	5SY5 232-7	196.00			
	40		5SY5 240-6	212.00	5SY5 240-7	212.00			
	50		5SY5 250-6	228.00	5SY5 250-7	228.00			
	63		5SY5 263-6	244.00	5SY5 263-7	244.00			

1) MW = modular width of 18 mm
 Depth 70 mm = device mounting depth of 70 mm

Control Circuit Protection Supplementary Protectors

Additional components for 5SY4,
5SY5 and 5SP4 supplementary protectors

勝特力材料 886-3-5753170
胜特力电子(上海) 86-21-34970699
胜特力电子(深圳) 86-755-83298787
Http://www.100y.com.tw

Features

- UL Recognized to UL 1077 (5ST3 010, 011, 012, 020, 021 & 022)
- Individual retrofitting possible
- Assembly via factory-fitted clips
- Short-circuit protection via supplementary protectors of characteristic B or C and $I_n = 6 A$ or 6 A gL fuses
- Low output versions in accordance with EN 61131-2 for controlling PLCs

Design

Auxiliary switches (AS) and fault signal contacts (FC) (5ST30.0, 5ST30.1, 5ST30.2)

- Min. contact load: 50 mA, 24 V
- Max. contact load:
NO contacts:
2 A, 400 V AC, AC-14
6 A, 230 V AC, AC-14
1 A, 220 V DC, DC-13
1 A, 110 V DC, DC-13
3 A, 60 V DC, DC-13
6 A, 24 V DC, DC-13
NC contacts:
2 A, 400 V AC, AC-13
6 A, 230 V AC, AC-13
1 A, 220 V DC, DC-13
1 A, 110 V DC, DC-13
3 A, 60 V DC, DC-13
6 A, 24 V DC, DC-13
- Connectable to *instabus EIB* and AS-Interface bus via binary inputs

Auxiliary switches (AS) with low output (5ST3013, 5ST3014, 5ST3015)

- Area of application: 1 mA / 5 V DC to 50 mA / 30 V DC

Application

Indication of the supplementary protectors' switching state:

- AS: ON/OFF
- FC: tripped

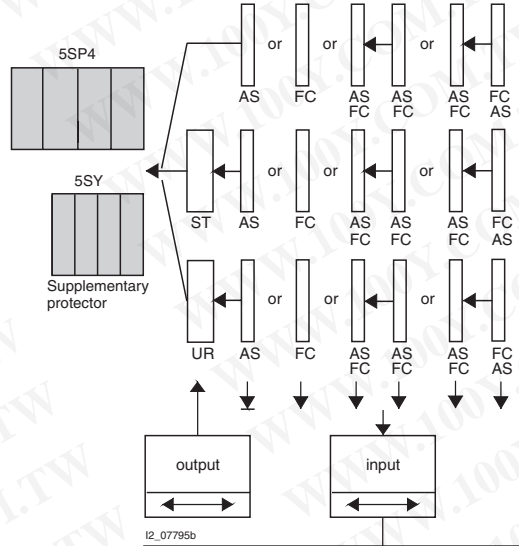

Selection and ordering data

	MW	Order No.	List Price \$ 1 item	Price group	Weight 1 item kg	Pack. unit Items
	Auxiliary switches (AS) for 5SY4, 5SY5, 5SP4 supplementary protectors					
		1 NO + 1 NC, low output ¹⁾	0.5	5ST3 010 5ST3 013	68.00 69.00	0.050 1
		2 NO, low output ¹⁾		5ST3 011 5ST3 014	34.00 69.00	
		2 NC, low output ¹⁾		5ST3 012 5ST3 015	34.00 69.00	
	Fault signal contacts (FC) for 5SY4, 5SY5, 5SP4 supplementary protectors					
		1 NO + 1 NC	0.5	5ST3 020	54.00	0.050 1
	2 NO		5ST3 021	54.00		
	2 NC		5ST3 022	54.00		

¹⁾UL/CSA pending

Features

Shunt trips

- Response limits acc. to DIN VDE 0660 Part 100, 7.2.1.4
- Suitable for voltages: 110 to 415 V AC, 110 V AC, 24 to 48 V AC/DC

Application

Remote tripping of the supplementary protectors

Selection and ordering data

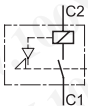
MW	Order No.	List Price \$ 1 item	Price group	Weight 1 item kg	Pack. unit Items
 <p>Shunt trips (ST) for 5SY4, 5SY5, 5SP4 supplementary protectors 1)</p>  <p>110-415 V AC 1 24-48 V AC/DC 1</p>	5ST3 030	105.00	027	0.098	1
	5ST3 031	105.00	027		

Features

Undervoltage releases

- Response limits acc. to DIN VDE 0660 Part 100, 7.2.1.3
- Suitable for voltages: 230 V AC, 110 V DC, 24 V DC
- Connectable to *instabus EIB* and AS-Interface bus via binary inputs.

Application

- Applicable as remote trip in an EMERGENCY-OFF loop
- Assures disconnection of the control circuit acc. to EN 60 204
- In cases of interrupted or insufficient voltage, the undervoltage release trips the supplementary protector or prevents it from switching on.

Selection and ordering data

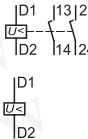
MW	Order No.	List Price \$ 1 item	Price group	Weight 1 item kg	Pack. unit Items
 <p>Undervoltage releases (UR) for 5SY4, 5SY5, 5SP4 supplementary protectors 1)</p>  <p>230 V AC 1 110 V DC 1 24 V DC 1</p> <p>230 V AC 1 110 V DC 1 24 V DC 1</p>	5ST3 040	153.00	027	0.115	1
	5ST3 041	153.00	027		
	5ST3 042	153.00	027		
	5ST3 043	154.00	027		
	5ST3 044	116.00	027		
	5ST3 045	188.00	027		

1) Without UL 1077 or CSA 22.2 No. 235-M 89

Control Circuit Protection Supplementary Protector Accessories

勝特力材料 886-3-5753170
 勝特力电子(上海) 86-21-34970699
 勝特力电子(深圳) 86-755-83298787
 Http://www.100y.com.tw



Accessories for 5SY supplementary protectors

Features

Busbar system ¹⁾



- Acc. to DIN 57 606 and DIN 57 659
- Load for one-side/central infeed: 65 A/120 A for 16 mm²
- Pin-type connections
- Single and multi-phase
- Cu: 16 mm² and fully insulated
- Lug spacing: 18 mm
- No additional connection terminal required for stranded connections up to 35 mm²
- Excellent accessibility of the feeder cables
- Busbars do not comply with UL1077

Selection and ordering data

	Length mm	Order No.	List Price \$ 1 item	Price group	Weight 1 item kg	Pack. unit Items
Accessories for 5SY4, 5SY5 miniature circuit-breakers						
Busbars 16mm ²						
Fully insulated:						
	1-phase	214	5ST3 700	13.00	027	0.040 50
	1-phase + AS		5ST3 702	16.00	027	
	2-phase		5ST3 704	25.00	027	0.060 25
	2-phase + AS		5ST3 706	31.00	027	
	3-phase		5ST3 708	37.00	027	0.100 25
	3-phase + AS		5ST3 711	46.00	027	
	3 × (1-phase + AS)		5ST3 713	46.00	027	
	4-phase		5ST3 715	58.00	027	0.150 20
	3-phase, for a 5SM3 4-pole RCCB module with 8 miniature circuit-breakers:					
	3/N + 8 connections		5ST3 717	37.00	027	0.150 25
Without end caps:						
	1-phase	1016	5ST3 701	36.00	027	0.190 50
	1-phase + AS		5ST3 703	48.00	027	
	2-phase		5ST3 705	99.00	027	0.290 20
	2-phase + AS		5ST3 707	124.00	027	
	3-phase		5ST3 710	149.00	027	0.430 20
	3-phase + AS		5ST3 712	187.00	027	
	3 × (1-phase + AS)		5ST3 714	184.00	027	
	4-phase		5ST3 716	228.00	027	0.700 15
End caps for lateral insulation of cut-to-length busbars						
			5ST3 748	1.70	027	0.001 10
			5ST3 750	1.90	027	0.001 10
			5ST3 718	31.00	027	0.001 10

1) Without UL 1077 or CSA 22.2, No. 235-M 89

Selection and ordering data

		Order No.	List Price \$	Weight kg	Pack. unit
Accessories for 5SY4, 5SY5, 5SP4 supplementary protectors				1 item	1 item Items
	Handle locking device applicable with all types of poles; sealable against unintended on- and off-switching; padlock with a shackle of max. 3 mm	5ST3 801	24.00	0.007	1
	Terminal cover applicable with all types of poles; as an additional cover for screw openings; prevents removal of the device from the standard mounting rail; sealable	5ST3 800	5.00	0.001	10
	Padlock for handle locking device 5ST3 801	5ST3 802	36.00	0.027	1
	Locking mechanism consisting of 5ST3 801 handle locking device and 5ST3 802 padlock	5ST3 803	60.00	0.027	1 set

Selection and ordering data

		Order No.	List Price \$	Weight kg	Pack. unit
	Inscription labels (white) for 5SY4, 5SY5, 5SP4 miniature circuit-breakers 15 x 9 mm, 3 frames containing 44 labels each, attachable to the lower casing collar • Self-adhesive	5ST2 173	115.00	0.038	1 Set

Control Circuit Protection

5SX2 Supplementary Protectors



勝特力材料 886-3-5753170
 勝特力电子(上海) 86-21-34970699
 勝特力电子(深圳) 86-755-83298787
[Http://www.100y.com.tw](http://www.100y.com.tw)

5SX2, N-type 55 mm mounting depth

Features

The 5SX2 has been approved acc. to **UL 1077 and CSA 22.2 No. 235-M 89** and can therefore be used as "supplementary protectors" for applications of up to 277 V AC (1-pole design) and 480 V AC (2-pole and 3-pole design).

Selection and ordering data

	I_n	MW	Characteristic A ¹⁾		Characteristic B		Characteristic C		Characteristic D		Weight 1 item	Pack. unit
			Order No.	List Price \$	Order No.	List Price \$	Order No.	List Price \$	Order No.	List Price \$		
1-pole												
	A			1 item		1 item		1 item		1 item	kg	Items
		0.3	1	-	-	-	5SX2 114-7 ¹⁾	54.00	-	-	0.140	12
		0.5	-	-	-	-	5SX2 105-7	54.00	5SX2 105-8	54.00		
		1	-	-	-	-	5SX2 101-7	54.00	5SX2 101-8	54.00		
		1.6	-	-	-	-	5SX2 115-7	54.00	5SX2 115-8	54.00		
		2	-	-	-	-	5SX2 102-7	54.00	5SX2 102-8	54.00		
		3	-	-	-	-	5SX2 103-7	54.00	5SX2 103-8	54.00		
		4	-	-	-	-	5SX2 104-7	54.00	5SX2 104-8	54.00		
		5	-	-	-	-	5SX2 111-7	54.00	-	-		
		6	-	-	-	-	5SX2 106-7	54.00	5SX2 106-8	54.00		
		8	-	-	-	-	5SX2 108-7	54.00	5SX2 108-8	54.00		
		10	-	-	-	-	5SX2 110-7	54.00	5SX2 110-8	54.00		
		13	-	-	-	-	5SX2 113-7	54.00	5SX2 113-8	54.00		
		15	-	-	-	-	5SX2 118-7	54.00	-	-		
		16	-	-	-	-	5SX2 116-7	54.00	5SX2 116-8	54.00		
		20	-	-	-	-	5SX2 120-7	54.00	5SX2 120-8	54.00		
		25	-	-	-	-	5SX2 125-7	54.00	5SX2 125-8	54.00		
	30	-	-	-	-	5SX2 130-7	54.00	-	-			
	32	-	-	-	-	5SX2 132-7	54.00	5SX2 132-8	54.00			
	40	-	-	-	-	5SX2 140-7	54.00	5SX2 140-8 ¹⁾	54.00	0.115		
	50	-	-	-	-	5SX2 150-7	54.00	5SX2 150-8 ¹⁾	54.00			
	63	-	-	-	-	5SX2 163-7 ¹⁾	54.00	-	-	0.150		
2-pole												
		0.5	2	-	-	5SX2 205-7	108.00	5SX2 205-8	108.00	0.280	6	
		1	-	-	-	5SX2 201-7	108.00	5SX2 201-8	108.00			
		1.6	-	-	-	5SX2 215-7	108.00	5SX2 215-8	108.00			
		2	-	-	-	5SX2 202-7	108.00	5SX2 202-8	108.00			
		3	-	-	-	5SX2 203-7	108.00	5SX2 203-8	108.00			
		4	-	-	-	5SX2 204-7	108.00	5SX2 204-8	108.00			
		5	-	-	-	5SX2 211-7	108.00	-	-			
		6	-	-	-	5SX2 206-7	108.00	5SX2 206-8	108.00			
		8	-	-	-	5SX2 208-7	108.00	5SX2 208-8	108.00			
		10	-	-	-	5SX2 210-7	108.00	5SX2 210-8	108.00			
		13	-	-	-	5SX2 213-7	108.00	5SX2 213-8	108.00			
		15	-	-	-	5SX2 218-7	108.00	-	-			
		16	-	-	-	5SX2 216-7	108.00	5SX2 216-8	108.00			
		20	-	-	-	5SX2 220-7	108.00	5SX2 220-8	108.00			
		25	-	-	-	5SX2 225-7	108.00	5SX2 225-8	108.00			
		30	-	-	-	5SX2 230-7	108.00	-	-			
		32	-	-	-	5SX2 232-7	108.00	5SX2 232-8	108.00			
	40	-	-	-	5SX2 240-7	108.00	5SX2 240-8 ¹⁾	108.00	0.300			
	50	-	-	-	5SX2 250-7	108.00	5SX2 250-8 ¹⁾	108.00				
	63	-	-	-	5SX2 263-7 ¹⁾	108.00	-	-				

1) Without UL 1077 or CSA 22.2 No. 235-M89

1 MW = modular width of 18 mm
 N-type = device mounting depth of 55 mm

Features

The 5SX2 has been approved acc. to **UL 1077 and CSA 22.2 No. 235-M 89** and can therefore be used as "supplementary protectors" for applications of up to 277 V AC (1-pole design) and 480 V AC (2-pole and 3-pole design).

Selection and ordering data

I_n	MW	Characteristic A ¹⁾		Characteristic B		Characteristic C		Characteristic D		Weight 1 item	Pack. unit
		Order No.	List Price \$ 1 item	Order No.	List Price \$ 1 item	Order No.	List Price \$ 1 item	Order No.	List Price \$ 1 item		
A										kg	Items
	3					5SX2 305-7	162.00	5SX2 305-8	162.00	0.440	4
	1	5SX2 301-5	162.00	-	-	5SX2 301-7	162.00	5SX2 301-8	162.00		
	1.6	5SX2 315-5	162.00	-	-	5SX2 315-7	162.00	5SX2 315-8	162.00		
	2	5SX2 302-5	162.00	-	-	5SX2 302-7	162.00	5SX2 302-8	162.00		
	3	5SX2 303-5	162.00	-	-	5SX2 303-7	162.00	5SX2 303-8	162.00		
	4	5SX2 304-5	162.00	-	-	5SX2 304-7	162.00	5SX2 304-8	162.00		
	5	-	-	-	-	5SX2 311-7	162.00	-	-		
	6	5SX2 306-5	162.00	5SX2 306-6	162.00	5SX2 306-7	162.00	5SX2 306-8	162.00		
	8	-	-	-	-	5SX2 308-7	162.00	5SX2 308-8	162.00		
	10	5SX2 310-5	162.00	5SX2 310-6	162.00	5SX2 310-7	162.00	5SX2 310-8	162.00		
	13	-	-	5SX2 313-6	162.00	5SX2 313-7	162.00	5SX2 313-8	162.00		
	15	-	-	-	-	5SX2 318-7	162.00	-	-		
	16	5SX2 316-5	162.00	5SX2 316-6	162.00	5SX2 316-7	162.00	5SX2 316-8	162.00		
	20	5SX2 320-5	162.00	5SX2 320-6	162.00	5SX2 320-7	162.00	5SX2 320-8	162.00		
	25	5SX2 325-5	162.00	5SX2 325-6	162.00	5SX2 325-7	162.00	5SX2 325-8	162.00		
	30	-	-	-	-	5SX2 330-7	162.00	-	-		
	32	5SX2 332-5	162.00	5SX2 332-6	162.00	5SX2 332-7	162.00	5SX2 332-8	162.00		
	40	5SX2 340-5	162.00	5SX2 340-6	162.00	5SX2 340-7	162.00	5SX2 340-8 ¹⁾	162.00	0.450	
	50	-	-	5SX2 350-6	162.00	5SX2 350-7	162.00	5SX2 350-8 ¹⁾	162.00		
	63	-	-	-	-	5SX2 363-7 ¹⁾	162.00	-	-		



3-pole



1) Without UL 1077 or CSA 22.2 No. 235-M 89

1 MW = modular width of 18 mm
 N-type = device mounting depth of 55 mm

Control Circuit Protection

5SX2 Supplementary Protectors

勝特力材料 886-3-5753170
 勝特力电子(上海) 86-21-34970699
 勝特力电子(深圳) 86-755-83298787
[Http://www.100y.com.tw](http://www.100y.com.tw)

Additional components for 5SX2

Accessories

Additional components

- Individually retrofittable

Auxiliary switches (AS) and fault signal contacts (FC)

- Auxiliary switch 5SX9100 UL recognized to UL1077
- Assembly with factory-fitted clips
- Max. contact load:
 6 A, 230 V AC, AC-15
 1 A, 220 V DC, DC-13
 acc. to DIN VDE 0660 Part 200, EN 60 947-5-1, DIN VDE 0640, and EN62019
- Short-circuit protection via 5SX supplementary protectors; with $I_n = 6$ A or gL 6 fuses

Application

Remote indication of the miniature circuit-breaker's switching state:
 - AS: ON/OFF
 - FS: tripped

Shunt trips (ST)





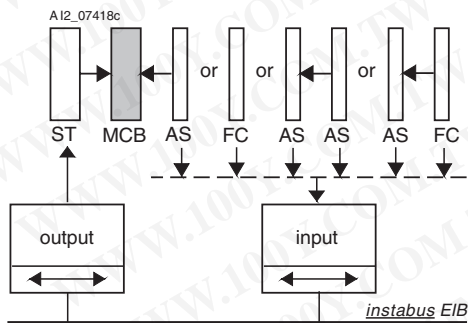

- Assembly with enclosed screws
- Applicable for voltages of 110 to 415 V AC
- Short-circuit protection via 5SX...-7 supplementary protectors with $I_n \geq 16$ A

Application

- Remote tripping of the supplementary protectors

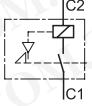

Selection and ordering data

	MW	Order No.	List Price \$	Weight 1 item	Pack. unit
			1 item	kg	Items
Auxiliary switches (AS)¹⁾					
	1 NO + 1 NC	0.5	5SX9 100	54.00	0.040 1
	2 NO		5SX9 101	54.00	
	2 NC		5SX9 102	54.00	
Fault signal contacts (FC)¹⁾					
	1 NO + 1 NC	0.5	5SX9 200	54.00	0.040 1
	2 NO		5SX9 201	91.00	
	2 NC		5SX9 202	54.00	
Shunt trip (ST)¹⁾					
	100% ED	1	5SX9 300	108.00	0.141 1

1) Without UL 1077 or CSA 22.2 No. 235-M 89 except 5SX9100

Accessories

5ST2 1 busbar system ¹⁾

Features











- Acc. to DIN 57 606 and DIN 57 659

- Load for one-side/central infeed:
50 A/90 A for 10 mm²
65 A/120 A for 16 mm²
- Fork-type connections

- Single and multi-phase
• Cu: 10 mm² and 16 mm², fully insulated

- Lug spacing: 18 mm
- No additional connection terminal required for bottom connection

Selection and ordering data

	Length mm	Order No.	List Price \$ 1 item	Weight 1 item	Pack. unit Items
Cu busbars 10 mm²					
With end caps					
	1-phase	5ST2 137	18.00	0.090	25
	2-phase	5ST2 138	21.50	0.100	10
	3-phase	5ST2 140	29.00	0.150	
Without end caps					
	1-phase	5ST2 146	56.00	0.410	10
	2-phase	5ST2 147	78.00	0.520	5
	3-phase	5ST2 148	106.00	0.840	10
Cu busbars 16 mm²					
With end caps					
	1-phase	5ST2 142	18.00	0.100	25
	2-phase	5ST2 143	21.50	0.150	10
	3-phase	5ST2 144	29.00	0.230	
	3-phase + N	5ST2 145		0.320	
Without end caps					
	1-phase	5ST2 151	65.00	0.490	10
	2-phase	5ST2 152	90.00	0.700	5
	3-phase	5ST2 153	123.00	1.100	10
	3-phase + N	5ST2 154	293.00	1.500	5
Without end caps					
lug spacing acc. to the devices' busbar mounting; 1-pole, 2-pole, 3-pole with one auxiliary switch each					
	1-phase + AS	5ST2 163	65.00	0.460	5
	2-phase + AS	5ST2 164	182.00	0.900	5
	3-phase + AS	5ST2 165	123.00	1.490	10
End caps					
for lateral insulation of cut-to-length busbars					
	1- and 2-phase	5ST2 155	1.20	0.013	10
	3- and 4-phase	5ST2 156	1.80	0.017	
Connection terminals up to 35 mm² (stranded)					
for top or bottom direct infeed into miniature circuit-breakers; side-by-side mounting possible for 1- and 2-phase busbars for 3- and 4-phase busbars					
		5ST2 166	12.00	0.002	10
		5ST2 167	12.00		
Connection terminal up to 35 mm² (stranded)					
for direct infeed into miniature circuit-breakers, side-by-side mounting possible					
		5ST2 157	10.10	0.030	10
Spacer (contour of N-type, 0.5 MW miniature circuit-breakers)					
		5ST2 122	3.80	0.002	10
Handle locking devices					
for N-type, 1-pole 5SX miniature circuit-breakers; for on-switching (red part) off-switching (transparent part)					
		5ST2 168	30.00		
		5ST2 170	38.50		
Covers					
applicable for the assembly of mini distribution boards;					
	• End plate	5ST2 134	11.00	0.022	10
	• Angled profile (approx. length: 1 m)	5ST2 135	24.50	0.330	5

1) Without UL 1077 or CSA 22.2 No. 235-M 89

Control Circuit Protection Supplementary Protectors, General Data

勝特力材料 886-3-5753170
 勝特力电子(上海) 86-21-34970699
 勝特力电子(深圳) 86-755-83298787
 Http://www.100y.com.tw

5SX, 5SY, and 5SP supplementary protectors

Technical data

Design	Tripping characteristic	Depth [mm]	Rated currents I_n	Standards			Rated short-circuit capacity ¹⁾ Energy limitation class
				UL 1077	EN 60 898	EN 60 947	
Standard product range							
5SX2	A	55	1 - 40 A	-	•	•	6 000 3
	B		6 - 50 A	•	•	•	
	C		0.3 - 63 A	•	•	•	
	D		0.5 - 50 A	•	•	•	
Industry guard product range							
5SY4	A	70	1 - 63 A	•	•	•	10 000 3
	B		6 - 63 A	•	•	•	
	C		0.3 - 63 A	•	•	•	
	D		0.3 - 63 A	•	•	•	
AC/DC product range							
5SY5	B	70	6 - 63 A	-	•	-	10 000 3
	C		0.3 - 63 A	-	•	-	
High-current product range							
5SP4	B	70	80 - 125 A	•	•	•	10 000
	C		80 - 125 A	•	•	•	
	D		80 - 100 A	•	•	•	

Part number selection chart

Series	Interrupting rating according to EN 60898 (kA)		Number of poles						Rated current (A)																		Tripping characteristic												
	6	10	1	2	3	4	1+N	3+N	0.3	0.5	1	1.6	2	3	4	5	6	8	10	13	15	16	20	25	30	32	40	50	63	80	100	125	A	B	C	D			
5SX	2		1	2	3						01	15	02	03	04		06		10			16	20	25		32	40							5					
	2		1	2	3												06		10	13		16	20	25		32	40	50						6					
	2		1						14	05	01	15	02	03	04	11	06	08	10	13	18	16	20	25	30	32	40	50	63							7			
	2			2	3					05	01	15	02	03	04	11	06	08	10	13	18	16	20	25	30	32	40	50	63								7		
	2		1	2	3					05	01	15	02	03	04	11	06	08	10	13		16	20	25		32	40	50										8	
5SY		4	1	2	3	4	5	6			01	15	02	03	04		06		10	13		16	20	25		32	40	50	63							5			
		4	1	2	3	4	5	6									06		10	13		16	20	25		32	40	50	63							6			
5SP		4	1	2	3	4																															6	7	
		4	1	2	3	4																																8	

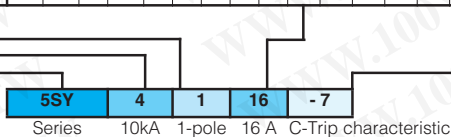

1) For UL 1077 rated breaking capacity see page 16/22

Technical data

		5SX2	5SY4	5SY5	5SP4
Tripping characteristic		A, B, C, D	A, B, C, D	B, C	B, C, D
Number of poles		•	•	•	•
	1	•	•	•	•
	1 + N	•	•	•	•
	2	•	•	•	•
	3	•	•	•	•
	3 + N	•	•	•	•
	4	•	•	•	•
Rated voltage UL 1077	V AC	277/480		-	277/480
	V DC	65/125		-	65/125
Operational voltage EN 60 898	min.	V AC/DC per pole	24		
	max.	V DC/pole	60 ¹⁾	220	60 ¹⁾
	max.	V AC	440		
Rated breaking capacity					
acc. to EN 60 898	kA AC	6	10		
	kA DC	-		10	
acc. to EN 60 947-2	kA AC	10	15	-	15
Insulation coordination					
Rated insulation voltage	V AC	250/440			
Degree of pollution for overvoltage category III		2			3
Protection against electrical shock		•	•	•	•
acc. to DIN VDE 106 Part 100					
Main switch characteristics			•	•	•
acc. to EN 60 204					
Sealability in handle end position		•	•	•	•
Device depth	mm	55	70		
acc. to DIN 43 880					
Degree of protection		IP 00 acc. to DIN 40 050, IP 20 acc. to DIN 40 050 for 5SY., IP 40 when mounted into distribution boards			
Flammability		Category IIb acc. to DIN VDE 0304 Part 3			
Mounting technique		Can be snapped onto 35 mm standard mounting rails (DIN EN 50 022); additionally with • 5SY: quick-assembly system (no tools required for assembly) • 5SP4: screw mounting also possible			
Terminals		5SX2: combined terminals at the bottom for a simultaneous connection of busbars (fork-type) and feeder cables 5SY: combined terminals at both sides for a simultaneous connection of busbars (fork-type) and feeder cables 5SP4: tunnel terminals at both sides			
Terminal tightening torque					
recommended	Nm	2.5 - 3			3 - 3.5
Conductor cross sections					
Solid and stranded, max.					
• upper terminal	mm ²	16	35		50
• lower terminal	mm ²	25	35		50
Finely stranded with end sleeves, max.					
• upper terminal	mm ²	10	25		35
• lower terminal	mm ²	16	25		35
Differing conductor cross sections may be clamped together simultaneously; details are available upon request.					
Supply connection		As required, the specified polarity must be observed for DC applications.			
Mounting position		As required.			
Service life		Averagely 20,000 operations at the rated load ²⁾ .			
Ambient temperature	°C	-25 ... +45; temporarily: +55; max. humidity: 95 %; storage temperature: -40 ... +75			
Resistance to climate		6 cycles acc. to IEC 60 068-2-30			
Resistance to vibrations	m/s ²	60 at 10 Hz up to 150 Hz acc. to IEC 60 068-2-6			

1) ≙ Battery charging voltage of 72 V.

2) ≙ 10,000 operations for 5SY5, 40 A, 50 A and 63 A at the rated load.

Control Circuit Protection Supplementary Protectors, General Data

Tripping characteristics and breaking capacity

勝特力材料 886-3-5753170
勝特力电子(上海) 86-21-34970699
勝特力电子(深圳) 86-755-83298787
Http://www.100y.com.tw

Tripping characteristics

Tripping performance at an ambient temperature of 30 °C

Tripping characteristic	Standards	Thermal release Test currents:				Electromagnetic release Test currents:		
		low test current I_1	high test current I_2	tripping time $63 A \geq I_n$ $63A \leq I_n$		hold I_4	trips at the latest at I_5	tripping time t
A		$1.13 \times I_n$	$1.45 \times I_n$	$> 1 h$ $< 1 h$	$> 2 h$ $< 2 h$	$2 \times I_n$	$3 \times I_n$	$\geq 0.1 s$ $< 0.1 s$
B	IEC 60 898/EN 60 898 DIN VDE 0641 Part 11	$1.13 \times I_n$	$1.45 \times I_n$	$> 1 h$ $< 1 h$	$> 2 h$ $< 2 h$	$3 \times I_n$	$5 \times I_n$	$\geq 0.1 s$ $< 0.1 s$
C		$1.13 \times I_n$	$1.45 \times I_n$	$> 1 h$ $< 1 h$	$> 2 h$ $< 2 h$	$5 \times I_n$	$10 \times I_n$	$\geq 0.1 s$ $< 0.1 s$
D		$1.13 \times I_n$	$1.45 \times I_n$	$> 1 h$ $< 1 h$	$> 2 h$ $< 2 h$	$10 \times I_n$	$20 \times I_n$	$\geq 0.1 s$ $< 0.1 s$

(IEC 60 898: $50 \times I_n$)

Breaking capacity

Breaking capacity ratings for UL1077 are broken down in four main line voltages that are tested. These voltages shown in the table below.

For IEC ratings, there are special requirements with regard to the breaking capacity.

The values are standardized and determined according to the testing conditions of EN 60 898 and DIN VDE 0641 Part 11.

The most usual values are

6 000 and 10 000.

For other test conditions, other values can be specified which lie above those of EN 60 898 and DIN VDE 0641 Part 11.

An example of another standard is EN 60 947-2 or DIN VDE 0660 Part 101 for MCBs.

Rated breaking capacity

Rated current	I_n [A]	UL 1077 1-pole 120/240 V AC	1-pole 240 V AC (in pairs)	1-pole 277 V AC	2-, 3-, 4-pole 480 V AC
		I_{cn} [kA]	I_{cn} [kA]	I_{cu} [kA]	I_{cu} [kA]
5SX2	0.5 - 63	14	7.5	5	5
5SP4	80 - 125	14	7.5	5	5
5SY4	0.3 - 63	14	7.5	5	5

Rated current	I_n [A]	UL 1077 1-pole 65 V DC	2-pole 125 V DC		
		I_{cn} [A]	I_{cn} [A]		
5SX2	0.5 - 63	400	600		
5SP4	80 - 125	400	600		
5SY4	0.3 - 63	400	600		

Rated current	I_n [A]	EN 60 898 (IEC 60 898) 1-pole 230 V AC	2-, 3-, 4-pole 400 V AC	EN 60 947-2 (IEC 60 947-2) 1-pole 230 V AC	2-, 3-, 4-pole 400 V AC
		I_{cn} [kA]	I_{cn} [kA]	I_{cu} [kA]	I_{cu} [kA]
5SX2	0.5 - 63	6	6	$10^{1)}$	$10^{1)}$
5SP4	80 - 125	10	10	15	15
5SY4	0.3 - 63	10	10	15	15

Rated current	I_n [A]	EN 60 898-2 1-pole 230 V AC	2-pole 400 V AC	EN 60 898-2 1-pole 220 V DC	2-pole 440 V DC
		I_{cn} [kA]	I_{cn} [kA]	I_{cn} [kA]	I_{cn} [kA]
5SY5	0.5 - 63	10	10	10	10

5SX2 supplementary protectors

5SX2,

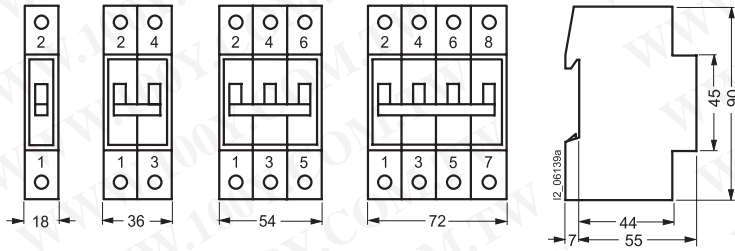

5SX9 auxiliary switch, 5SX9 fault signal

Additional component for 5SX2; can be retrofitted 5SX9 1.., 5SX9 2..

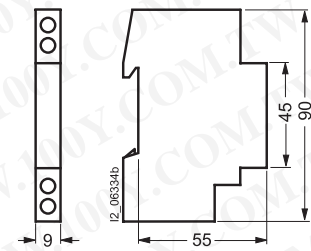

5SY4, 5SY5 supplementary protectors 5SJ4, single pole branch circuit protector

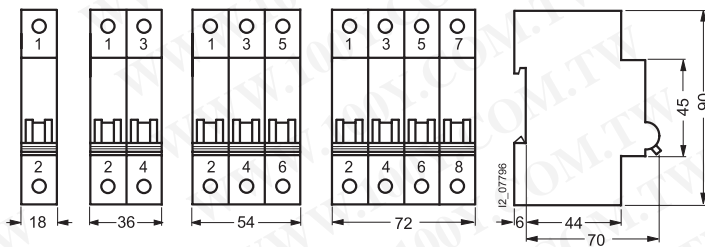

5ST3 auxiliary switch 5ST3 fault signal contact

can be retrofitted to 5SY4, 5SY5, 5SP4

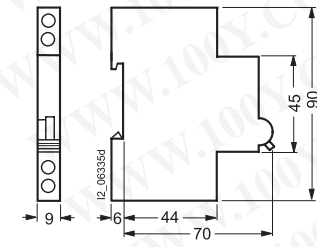

5SP4 supplementary protectors

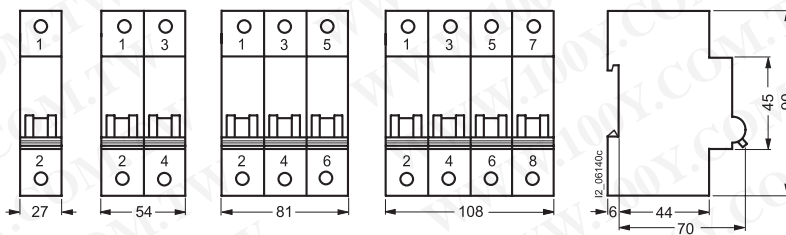

5ST3 shunt trip 5ST3 undervoltage release

can be retrofitted to 5SY4, 5SY5, 5SP4

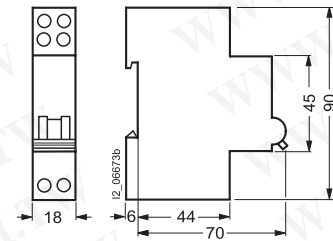

Control Circuit Protection

General Data

勝特力材料 886-3-5753170
勝特力电子(上海) 86-21-34970699
勝特力电子(深圳) 86-755-83298787
[Http://www.100y.com.tw](http://www.100y.com.tw)

3NW7 Cylindrical Fuse Holders

Key Common Features

- Meets a wide variety of fuse sizes
- Multi-pole configurations
- Standard 35 mm (DIN) rail mounting
- Housing material meets UL-94-V0, self-extinguishing
- Meets UL 512 and CSA C22.2, No. 39 certifications
- CE Mark
- No tools required for insertion or removal of fuses
- Finger safe design
- With or without Blown Fuse Indicator

Description

Depending on the cylindrical* fuse size selected 3NW7 fuse holders are available in 1, 1 + N, 2, 3, 3 + N and 4 pole configurations. Fuse sizes include 13/32" x 1-1/2" (Class CC and Midget), 8 mm x 32 mm, 10 mm x 38 mm, 14 mm x 51 mm and 22 x 58 mm.

Class CC fuse holders are UL Listed for branch circuit protection according to UL 512 and CSA C22.2, No. 39. They incorporate a rejection feature that only allows Class CC fuses to be used.

Midget, 8 mm x 32 mm, 10 mm x 38 mm, 14 mm x 51 mm, and 22 x 58 mm fuse holders are UL Recognized (refer to Technical Data for specific fuse holder certifications) as supplementary protectors according to UL 512 and CSA C22.2, No. 39. Supplementary protectors are designed to provide additional protection along with branch circuit protection devices.

All fuse holders are equipped with either a fuse handle or draw mechanism for easy insertion and removal of cylindrical type fuses. During insertion and removal the fuses are isolated from the power/control circuit. Their compact size requires less space than typical open-type fuse holders and they mount directly onto standard 35 mm mounting rails.

Fuse holders for 8 mm x 32 mm, 10 mm x 38 mm fuses in the 1 + N draw design occupy the same mounting space as 1 pole designs. This unique design saves space when compared to the typical handle type fuse holder which requires two poles.

1
2
3
4
5
6
7
8
9
10
11
12
13
14
15
16

Selection and ordering data

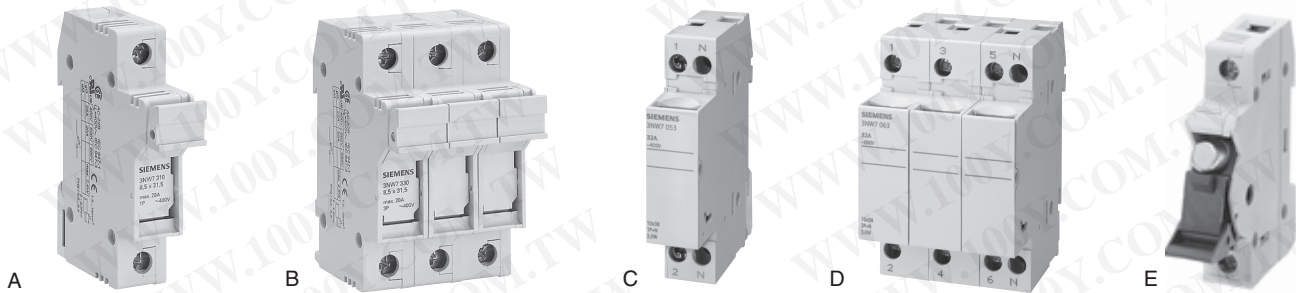

Construction Type

Class CC Fuse Holders: UL Listed for Branch Circuit Protection

No. of Poles	In A	Fuse Size mm x mm	Without Blown Fuse Indicator			With Blown Fuse Indicator ²⁾			
			Order No.	List Price \$ 1 Item	Construction Type	Weight 1 Item kg	Order No.	List Price \$ 1 Item	Construction Type
1 2 3	30	Class CC 10.3 x 38.1 (13/32" x 1-1/2")	3NW7513-0HG 3NW7523-0HG 3NW7533-0HG	32.00 63.00 95.00	E ¹⁾	0.056 0.118 0.172	— — —	— — —	— — —

Midget Class Fuse Holders: UL Recognized for Supplementary Protection

No. of Poles	In A	Fuse Size mm x mm	Without Blown Fuse Indicator			With Blown Fuse Indicator ²⁾				
			Order No.	List Price \$ 1 Item	Construction Type	Weight 1 Item kg	Order No.	List Price \$ 1 Item	Construction Type	Weight 1 Item kg
1 1 + N 2 3 3 + N	30	Midget Class 10.3 x 38.1 (13/32" x 1-1/2")	3NW7011 3NW7051 3NW7021 3NW7031 3NW7061	11.30 35.00 25.50 35.00 52.00	A & B ¹⁾	0.080 0.167 0.162 0.243 0.327	3NW7012 3NW7052 3NW7022 3NW7032 3NW7062	14.00 37.00 27.00 43.00 65.00	A & B	0.080 0.167 0.162 0.243 0.327









Other Supplementary Protectors (Refer to page 16/26 for UL and CSA status)

No. of Poles	In A	Fuse Size mm x mm	Without Blown Fuse Indicator			With Blown Fuse Indicator ²⁾				
			Order No.	List Price \$ 1 Item	Construction Type	Weight 1 Item kg	Order No.	List Price \$ 1 Item	Construction Type	Weight 1 Item kg
1	20	8 x 32	3NW7313	14.00	C	0.058	3NW7312	16.00	A	0.058
	32	10 x 38	3NW7013	11.30	C	0.080	3NW7012	14.00	A	0.080
	50	14 x 51	3NW7111	27.00	A	0.095	3NW7112	29.00	A	0.095
	100	22 x 58	3NW7211	29.00	A	0.145	3NW7212	36.00	A	0.145
1 + N	20	8 x 32	3NW7353	21.00	C & D ¹⁾	0.120	3NW7352	26.00	A & B ¹⁾	0.120
	32	10 x 38	3NW7053	35.00	C & D ¹⁾	0.167	3NW7052	37.00	A & B ¹⁾	0.167
	50	14 x 51	3NW7151	51.00	A & B ¹⁾	0.215	3NW7152	61.00	A & B ¹⁾	0.215
	100	22 x 58	3NW7251	73.00	A & B ¹⁾	0.330	3NW7252	88.00	A & B ¹⁾	0.330
2	20	8 x 32	3NW7323	17.00	C & D ¹⁾	0.112	3NW7322	20.00	A & B ¹⁾	0.112
	32	10 x 38	3NW7023	25.00	C & D ¹⁾	0.162	3NW7022	27.00	A & B ¹⁾	0.162
	50	14 x 51	3NW7121	50.00	A & B ¹⁾	0.195	3NW7122	52.00	A & B ¹⁾	0.195
	100	22 x 58	3NW7221	61.00	A & B ¹⁾	0.300	3NW7222	72.00	A & B ¹⁾	0.300
3	20	8 x 32	3NW7333	30.00	C	0.167	3NW7332	37.00	B	0.167
	32	10 x 38	3NW7033	35.00	C	0.243	3NW7032	43.00	B	0.243
	50	14 x 51	3NW7131	73.00	B	0.295	3NW7132	77.00	B	0.295
	100	22 x 58	3NW7231	121.00	B	0.691	3NW7232	121.00	B	0.480
3 + N	20	8 x 32	3NW7363	34.00	C & D ¹⁾	0.227	3NW7362	44.00	A & B ¹⁾	0.227
	32	10 x 38	3NW7063	52.00	C & D ¹⁾	0.327	3NW7062	65.00	A & B ¹⁾	0.327
	50	14 x 51	3NW7161	94.00	A & B ¹⁾	0.315	3NW7162	113.00	A & B ¹⁾	0.315
	100	22 x 58	3NW7261	175.00	A & B ¹⁾	0.475	3NW7262	185.00	A & B ¹⁾	0.475

1) Same Mechanical Design - Other Pole Types Not Shown
 2) LED is "ON" when fuse is blown (open)

3NW7 Cylindrical Fuse Holders

Technical data

Type	Class CC	Midget 3NW70.1	3NW73.2	3NW73.3	3NW70.3	3NW70.2	3NW71..	3NW72..
Fuse Size (mm x mm)	10.3 x 38.1 (13/32" x 1-1/2")	10.3 x 38.1 (13/32" x 1-1/2")	8 x 32	8 x 32	10 x 38	10 x 38	14 x 51	22 x 58
Standards	UL 512		IEC 60269-1, -2, -2-1 NF C 60-200, 63-210, 63-211 NBN C 63269-2en-2-1 CEI 32-4, -12					
Certifications	UL Listed			Pending				Pending
				Pending				Pending
Rated Voltage (IEC) [V AC]	—	—	400		690			
Rated Voltage (UL) [V AC]	600		400		690			
Rated Current (AC) [A]	0.1 to 30		2 to 20		0.5 to 32		2 to 50	8 to 100
Rated Breaking Capacity [kA]	Fuse Selection Dependent		20		100			
Utilization Category	—	—	AC 20B (Switching without load) DC 20B	AC 20B AC 22B (Switching without load) DC 20B	AC 20B (Switching without load)			
Mounting Position	Any Required (suggest vertical)							
Dimensions	See Catalog Page 16/27							
Finger Touch Safe	Yes							
Degree of Protect according to IEC 60529	IP20							
Operating Temperature Range [°C]	-5 to + 40; 90% max. humidity at +20							
Wire Size [mm ²]	Solid		1.5 to 10				2.5 to 10	4 to 10
	Stranded		2.5 to 16	1.5 to 10		2.5 to 16	2.5 to 25	4 to 50
	Finely Stranded		1.5 to 10				2.5 to 16	4 to 35
Wire Size According to UL/CSA [AWG]			18 to 10 solid				10 to 6 solid or stranded	
Terminal Tightening Torque [Nm]			2.0	1.2	2.0		2.5	

Dimensional drawings

Typical Construction Type C & D

3NW73.3: Fuse Size 8 mm x 32 mm
 3NW70.3: Fuse Size 10 mm x 38 mm

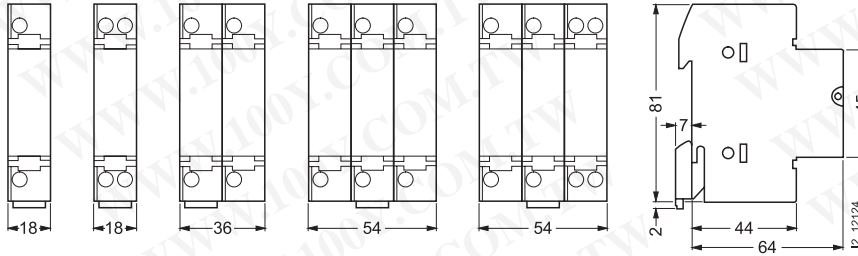

Typical Construction Type A & B

3NW73.2: Fuse Size 8 mm x 32 mm
 3NW70.2: Fuse Size 10 mm x 38 mm
 3NW7.1 Midget: 10.3 mm x 38.1 mm (13/32" x 1-1/2")

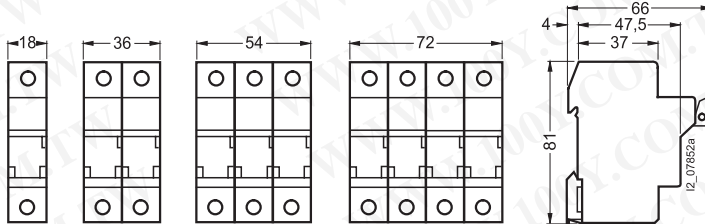

3NW71: 14 mm x 51 mm

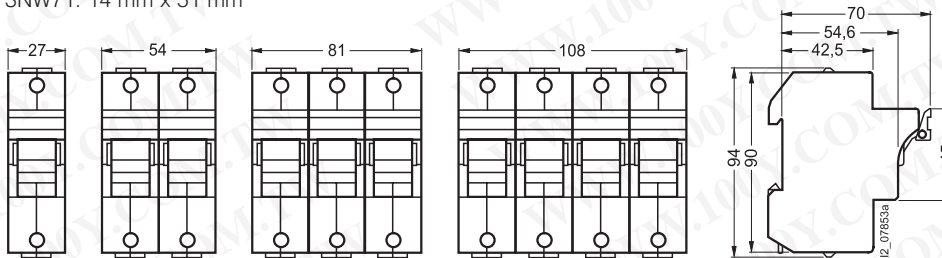

3NW72: 22 mm x 58 mm

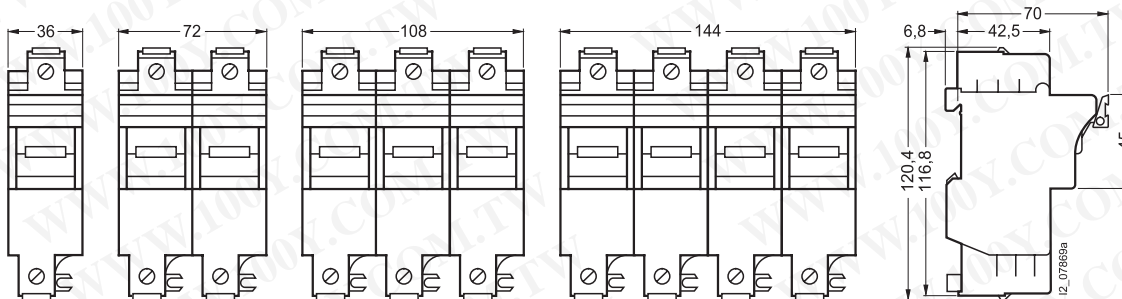

Control Circuit Protection Supplementary Protectors

3NC10 Open Cylindrical Fuse Holders

Features

3NC1038 open fuse holders have been certified in accordance with UL 512 and can be used with 13/32" x 1-1/2" (10 x 38 mm) fuses up to 600 V AC, 30 Amperes maximum.

- Type M Supplementary Fuse Holder for use with 13/32" x 1-1/2" (10 x 38 mm) Fuses
- Typical Supplementary Fuses: Bussmann KTK, FNQ, FNM, BAF and BAN. Includes MIDGET Class Fuses
- Ampere Rating: 1/10 to 30 A
- Voltage Rating: 600 V
- Withstand Rating: 10,000 RMS Symmetrical (or interrupting rating of the fuse used, whichever is lower)
- Wire Range: 14 to 6 AWG
- UL Recognized, UL 512, Fuse Holder
- UL Flammability: 94VO
- Holder Material: Thermoplastic
- Surface Mounted

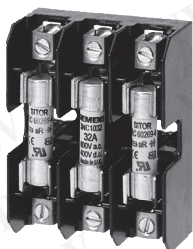

勝特力材料 886-3-5753170
 勝特力电子(上海) 86-21-34970699
 勝特力电子(深圳) 86-755-83298787
[Http://www.100y.com.tw](http://www.100y.com.tw)

Selection and ordering

Description	Number of poles	Order Number	List Price \$	Weight Item kg
Cylindrical Fuse Holder Type M, Supplementary Fuses for 13/32" x 1-1/2" (10 x 38 mm)	1	3NC1038-1	11.50 ea.	0.042
	2	3NC1038-2	25.50 ea.	0.077
	3	3NC1038-3	35.00 ea.	0.113

Dimensions

