

RoHS (Pb) HF Lo Rho Surface Mount Series

Description

The Littelfuse Lo Rho Surface Mount PPTC (polymer positive temperature coefficient) series offers ultra low normal operating resistance while maintaining the same performance of existing Littelfuse PPTC products. Available in 8 hold current ratings, all devices are TUV and UL certified and have maximum fault current of 40A.

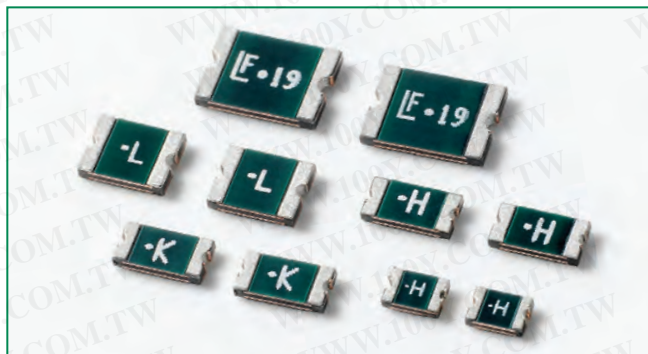

Features

- Lo Rho (low resistance at normal operating hold current)
- RoHS compliant, Lead Free and Halogen Free
- Fast response to fault currents
- Compact design saves board space
- Thin-profile <0.75mm
- Compatible with high temperature solders
- 0805L150 and 1206L150 ideal for USB 3.0

Applications



- USB peripherals including new USB 3.0 standard
- Disk drives
- CD-ROMs
- PDA's / digital cameras
- Plug and play protection for motherboards and peripherals
- Game console port protection

Agency Approvals

AGENCY	AGENCY FILE NUMBER
	E183209
	R50119118

勝特力材料 886-3-5753170
 勝特力电子(上海) 86-21-34970699
 勝特力电子(深圳) 86-755-83298787
[Http://www.100y.com.tw](http://www.100y.com.tw)

Electrical Characteristics

Part Number	Marking	I _{hold} (A)	I _{trip} (A)	V _{max} (Vdc)	I _{max} (A)	P _d typ. (W)	Maximum Time-To-Trip		Resistance		Agency Approvals	
							Current (A)	Time (Sec.)	R _{min} (Ω)	R _{1max} (Ω)		
0805L075SLYR	-G	0.75	1.50	6	50	0.6	8.00	0.20	0.040	0.160	X	X
0805L110SLYR	-H	1.10	1.80	6	50	0.6	8.00	0.30	0.030	0.130	X	X
0805L150SLYR	-K	1.50	3.00	6	50	0.6	8.00	0.50	0.015	0.065	X	X
1206L110SLYR	-H	1.10	2.20	6	50	0.8	8.00	0.30	0.015	0.100	X	X
1206L150SLYR	-K	1.50	3.00	6	50	0.8	8.00	0.30	0.010	0.065	X	X
1206L300SLWVR	-N	3.00	6.00	6	50	0.8	8.00	4.00	0.003	0.020	X	X
1206L350SLWVR	-T	3.50	7.00	6	50	0.8	8.00	5.00	0.003	0.018	X	X
1206L380SLWVR	X	3.80	8.00	6	50	0.8	8.00	5.00	0.002	0.016	X	X
1210L200SLYR	-L	2.00	4.00	6	50	0.8	8.00	3.00	0.005	0.024	X	X
1210L350SLWVR	-T	3.50	7.00	6	50	0.8	17.50	2.00	0.003	0.018	X	X
1210L380SLYR	X	3.80	8.00	6	50	1.0	8.00	5.00	0.002	0.016	X	X
1812L190SLPR	LF 19	1.90	4.90	6	50	1.0	9.50	4.50	0.003	0.025	X	X
1812L350SLPR*	LF-35	3.50	8.10	6	50	1.0	17.50*	2.00*	0.003	0.025**	X	X

Notes:

0805L150 and 1206L150 are ideal to serve VBus protection of USB 3.0 port applications

*1812L350 Typical Time-to-Trip is 50A at 0.013-0.020 seconds and meets the 8A at 5 seconds maximum Time-to-Trip requirement.

**1812L350 R_{1min}=0.015ohm (resistance range 0.015-0.025ohm).

I_{hold} = Hold current: maximum current device will pass without tripping in 20°C still air.

I_{trip} = Trip current: minimum current at which the device will trip in 20°C still air.

V_{max} = Maximum voltage device can withstand without damage at rated current (I_{max}).

I_{max} = Maximum fault current device can withstand without damage at rated voltage (V_{max}).

P_d = Power dissipated from device when in the tripped state at 20°C still air.

R_{min} = Minimum resistance of device in initial (un-soldered) state.

R_{1max} = Maximum resistance of device at 20°C measured one hour after tripping or reflow soldering of 260°C for 20 sec.

Caution: Operation beyond the specified rating may result in damage and possible arcing and flame.

Temperature Derating

Ambient Operation Temperature								
	-40°C	-20°C	0°C	20°C	40°C	60°C	70°C	85°C
Part Number	Hold Current (A)							
0805L075SLYR	1.24	1.07	0.94	0.75	0.62	0.47	0.37	0.23
0805L110SLYR	1.93	1.65	1.38	1.10	0.83	0.55	0.41	0.21
0805L150SLYR	2.37	2.07	1.80	1.50	1.25	0.93	0.74	0.50
1206L110SLYR	2.00	1.70	1.40	1.10	0.83	0.56	0.44	0.24
1206L150SLYR	2.67	2.32	1.95	1.50	1.15	0.78	0.64	0.36
1206L300SLWVR	4.35	3.90	3.60	3.00	2.61	2.04	1.74	1.05
1206L350SLWVR	5.53	4.79	4.20	3.50	2.91	2.19	1.96	1.44
1206L380SLWVR	6.00	5.13	4.56	3.80	3.15	2.47	1.98	1.60
1210L200SLYR	3.26	2.87	2.50	2.00	1.70	1.29	1.09	0.78
1210L350SLWVR	5.00	4.60	4.05	3.50	2.80	2.00	1.60	1.00
1210L380SLYR	6.00	5.28	4.52	3.80	3.15	2.39	2.09	1.60
1812L190SLPR	3.00	2.58	2.22	1.90	1.49	1.14	0.93	0.61
1812L350SLPR	5.43	4.73	4.13	3.50	2.80	2.10	1.75	1.12

Average Time Current Curves

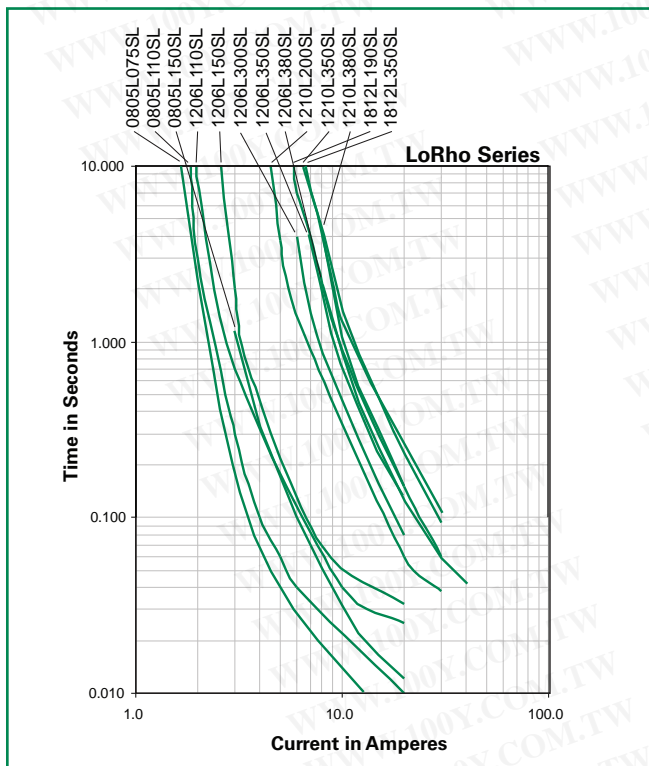

The average time current curves and Temperature Derating curve performance is affected by a number of variables, and these curves provided as guidance only. Customer must verify the performance in their application.

Physical Specifications

Terminal Material	Solder-Plated Copper (Solder Material: Matte Tin (Sn))
Lead Solderability	Meets EIA Specification RS186-9E, ANSI/J-STD-002, Category 3.

Temperature Derating Curve

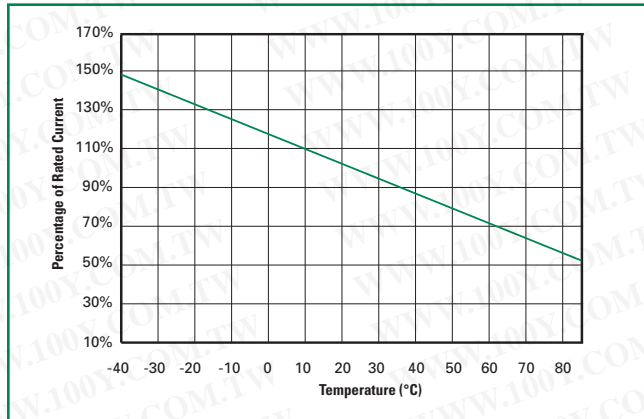

Environmental Specifications

Operating Temperature	-40°C to +85°C
Maximum Device Surface Temperature in Tripped State	125°C
Passive Aging	+85°C, 1000 hours -/+ 10% typical resistance change
Humidity Aging	+85°C, 85% R.H., 100 hours -/+ 15% typical resistance change
Thermal Shock	MIL-STD-202, Method 107G +85°C/-40°C 20 times -30% typical resistance change
Solvent Resistance	MIL-STD-202, Method 215 No change
Vibration	MIL-STD-883C, Method 2007.1, Condition A No change
Moisture Sensitivity Level	Level 1, J-STD-020C

Soldering Parameters

Profile Feature		Pb-Free Assembly
Average Ramp-Up Rate ($T_{S(max)}$ to T_p)		3°C/second max
Pre Heat:	Temperature Min ($T_{s(min)}$)	150°C
	Temperature Max ($T_{s(max)}$)	200°C
	Time (Min to Max) (t_s)	60 – 180 secs
Time Maintained Above:	Temperature (T_L)	217°C
	Temperature (t_t)	60 – 150 seconds
Peak / Classification Temperature (T_p)		260 ^{+0/-5} °C
Time within 5°C of actual peak Temperature (t_p)		20 – 40 seconds
Ramp-down Rate		6°C/second max
Time 25°C to peak Temperature (T_p)		8 minutes Max.

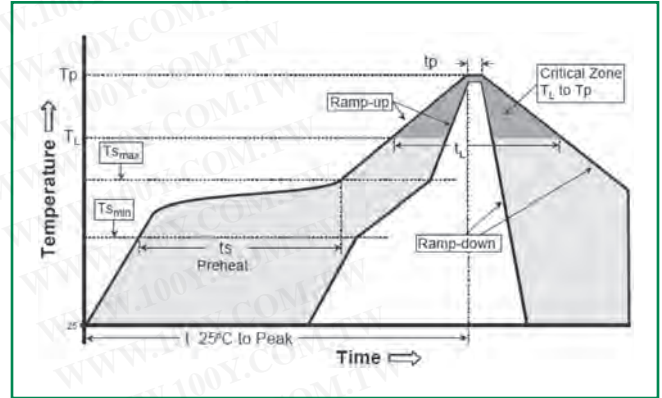

- All temperature refer to topside of the package, measured on the package body surface
- If reflow temperature exceeds the recommended profile, devices may not meet the performance requirements
- Recommended reflow methods: IR, vapor phase oven, hot air oven, N₂ environment for lead
- Recommended maximum paste thickness is 0.25mm (0.010 inch)
- Devices can be cleaned using standard industry methods and solvents
- Devices can be reworked using the standard industry practices

Dimensions

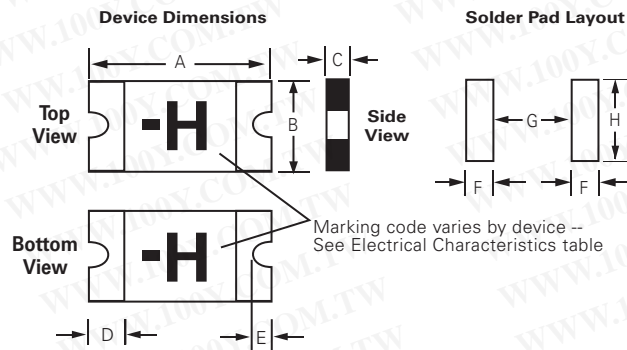

Part Number	Device Dimension										Solder Pad Layout		
	A		B		C		D		E		F	G	H
	mm	mm	mm	mm	mm	mm	mm	mm	mm	mm	mm	mm	
0805L075SLYR	2.00	2.20	1.20	1.50	0.40	0.75	0.20	0.55	0.05	0.45	1.00	1.20	1.50
0805L110SLYR	2.00	2.20	1.20	1.50	0.40	0.75	0.20	0.55	0.10	0.45	1.00	1.20	1.50
0805L150SLYR	2.00	2.20	1.20	1.50	0.40	0.75	0.20	0.55	0.10	0.45	1.00	1.20	1.50
1206L110SLYR	3.00	3.40	1.50	1.80	0.40	0.75	0.25	0.75	0.10	0.45	1.00	1.80	1.80
1206L150SLYR	3.00	3.40	1.50	1.80	0.40	0.70	0.25	0.75	0.10	0.45	1.00	1.80	1.80
1206L300SLWR	3.00	3.40	1.50	1.80	0.60	1.00	0.25	0.75	0.05	0.45	1.00	1.80	1.80
1206L350SLWR	3.00	3.40	1.50	1.80	0.60	1.00	0.25	0.75	0.05	0.45	1.00	1.80	1.80
1206L380SLWR	3.00	3.40	1.50	1.80	0.60	1.00	0.25	0.75	0.05	0.45	1.00	1.80	1.80
1210L200SLYR	3.00	3.43	2.35	2.80	0.40	0.70	0.25	0.75	0.20	0.50	1.00	2.00	2.50
1210L350SLWR	3.00	3.43	2.35	2.80	0.60	1.00	0.25	0.75	0.20	0.50	1.00	2.00	2.50
1210L380SLYR	3.00	3.43	2.35	2.80	0.40	0.65	0.25	0.75	0.10	0.50	1.00	2.00	2.50
1812L190SLPR	4.37	4.73	3.07	3.41	0.40	0.70	0.30	1.20	0.25	0.65	1.78	3.45	3.15
1812L350SLPR	4.37	4.73	3.07	3.41	0.40	0.70	0.30	1.20	0.25	0.65	1.78	3.45	3.15

Part Ordering Number System

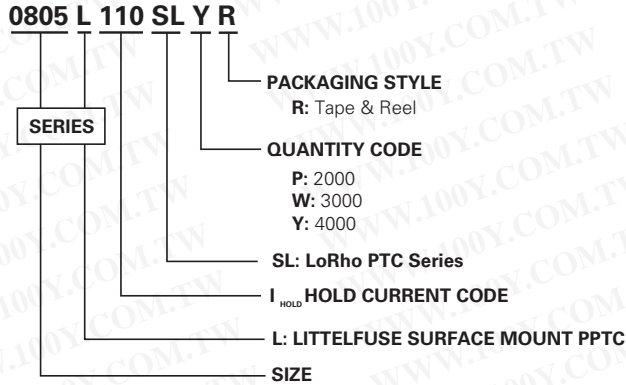

勝特力材料 886-3-5753170
 勝特力电子(上海) 86-21-34970699
 勝特力电子(深圳) 86-755-83298787
 Http://www.100y.com.tw

Packaging

Part Number	I_{hold} (A)	I_{hold} Code	Packaging Option	Quantity	Quantity & Packaging Codes
0805L075SLYR	0.75	075	Tape & Reel	4000	YR
0805L110SLYR	1.10	110		4000	YR
0805L150SLYR	1.50	150		4000	YR
1206L110SLYR	1.10	110		4000	YR
1206L150SLYR	1.50	150		4000	YR
1206L300SLWR	3.00	300		3000	WR
1206L350SLWR	3.50	350		3000	WR
1206L380SLWR	3.80	380		3000	WR
1210L200SLYR	2.00	200		4000	YR
1210L350SLWR	3.50	350		3000	WR
1210L380SLWR	3.80	380		3000	WR
1812L190SLPR	1.90	190		2000	PR
1812L350SLPR	3.50	350		2000	RR

Tape and Reel Specifications

TAPE SPECIFICATIONS: EIA-481-1 (mm)				
	0805L075SL 0805L110SL 0805L150SL	1206L110SL 1206L150SL 1206L300SL 1206L350SL 1206L380SL	1210L200SL 1210L350SL 1210L380SL	1812L190SL 1812L350SL
W	8.0+/-0.10	8.15+0.15-0.30	8.0+/-0.30	12.00+0.30-0.10
F	3.5+/-0.05	3.50+/-0.05	3.5+/-0.05	5.50+/-0.05
E₁	1.75+/-0.10	1.75+/-0.10	1.75+/-0.10	1.75+/-0.10
D₀	1.55+/-0.05	1.55+/-0.05	1.55+/-0.05	1.50+0.10
D₁	1.0 (min)	1.00 (MIN)	1.0 (min)	1.50+0.25
P₀	4.0+/-0.10	4.00+/-0.10	4.0+/-0.10	4.00+/-0.10
P₁	4.0+/-0.10	4.00+/-0.10	4.0+/-0.10	8.00+/-0.10
P₂	2.0+/-0.05	2.00+/-0.05	2.0+/-0.05	2.00+/-0.05
A₀	1.45+/-0.10	1.95+/-0.10	2.82+/-0.10	3.58+/-0.10
B₀	2.30+/-0.10	3.65+/-0.10	3.46+/-0.10	4.93+/-0.10
T	0.25+/-0.10	0.25+/-0.10	0.25+/-0.10	0.25+/-0.10
K₀	0.74+/-0.10	0.87+/-0.10	1.00+/-0.10	1.02+/-0.10
Leader min.	390	390	390	390
Trailer min.	160	160	160	160

REEL DIMENSIONS: EIA-481-1 (mm)		
	0805L075SL 0805L110SL 0805L150SL 1210L200SL 1210L350SL 1210L380SL	1206L110SL 1206L150SL 1206L300SL 1206L350SL 1206L380SL 1812P190SL 1812L350SL
H	12.0+/-0.05	16.0+/-0.2
W	9.0+/-0.5	13.2+/-1.5
D	Ø60+0.5	Ø 60.2+/-0.5
F	Ø13.0+/-0.2	Ø 13.0+/-0.5
C	Ø178+/-1.0	Ø 178+/-1.0
H₁	11+/-0.5	11+/-0.5
W₁	2.2+/-0.5	2.5+0.5
W₂	3.0+0.5	3.0+0.5
W₃	4.0+0.5	4.0+0.5
W₄	5.5+0.5	5.0+0.5

Tape and Reel Diagram

