



GS Semiconductor fuselinks



勝特力材料 886-3-5753170
勝特力电子(上海) 86-21-54151736
勝特力电子(深圳) 86-755-83298787
[Http://www.100y.com.tw](http://www.100y.com.tw)





TYPE 'GS'

Semiconductor Fuselinks

Technical information

Full GS range of fuselinks are designed to the requirements of IEC269 -IV (1986)

Precise Pre-determined performance ensuring low arc voltage and minimum let through of current and energy.

Exceptionally compact dimensions.

Available in a wide range of current and voltage ratings.

Versions available with dimensions, to British* requirements.

Special versions also available to suit particular applications.

* This catalogue covers 'British' version.

勝特力材料 886-3-5753170
勝特力电子(上海) 86-21-54151736
勝特力电子(深圳) 86-755-83298787
[Http://www.100y.com.tw](http://www.100y.com.tw)

Fast acting British fixing centres

A.C. Voltage Rating	MAX.D.C. Voltage Rating Time Constant 20m secs.	Nominal R.M.S Current Rating Amp.	List number For Ordering Purpose Not Incorporating Trip Indicator fuse	Dimensions See Fig.					
240V R.M.S. also tested to 318V R.M.S	200V	5	GSA5	1					
		10	GSA10						
		15	GSA15						
		20	GSA 20						
		600V R.M.S. also tested to 707V R.M.S	400V	25	GSA25	2			
				35	GSA35				
				50	GSA50				
				75	GSA 75				
				100	GSA 100				
						150	GS450/150	3	
200	GS450/200								
250	GS450/250								
						300	GS450/300	4	
						400	GS450/400		
		500	GS450/500						
						5	GSB5		1
						10	GSB10		
15	GSB15								
20	GSB20								
				25	GSB25	2			
		45	GSB45						
		50	GSB50						
		75	GSB75						
				100	GS1000/100		3		
150	GS1000/150								
200	GS1000/200								
				250	GS1000/250	4			
				300	GS1000/300				
		400	GS1000/400						
		500	GS1000/500						



GS Semiconductor Fuselinks

ULTRA Fast acting British fixing centres

A.C Voltage Voltage Rating	Max D.C. Voltage Rating Time Const. 20m secs	Normal R.M.S. Current Rating Amp.	List Number For ordering Purpose Not Incorporating Trip Indicator Fuse	Dimesnions See Fig.
800V R.M.S also tested to 880V R.M.S	500V	63	+ GSMJ63	7
		120	+ GSMJ120	8
		180	+ GSMJ180	9
		240	+ GSMJ240	10
		300	+ GSMJ300	11
		350	+ GSMJ350	12
		400	GSMJ400	13
		460	GSMJ460	13
		520	GSMJ520	13
		580	GSMJ580	13
		630	GSMJ630	13
		680	GSMJ680	13
		800	GSMJ800	14
		1000	GSMJ1000	14
		1200	GSMJ1200	14
1000V R.M.S also tested to 1100V R.M.S	700V	63	++ GSMK63	7
		120	++ GSMK120	8
		180	++ GSMK180	9
		240	++ GSMK240	10
		300	++ GSMK300	11
		350	++ GSMK350	12
		400	GSMK400	13
		460	GSMK460	13
		520	GSMK520	13
		580	GSMK580	13
		630	GSMK630	13
		680	GSMK680	13
		800	GSMK800	14
		1000	GSMK1000	14
		1200	GSMK1200	14

+ End terminations with side and end slots meets DIN 43653 110 mm fixing centres
 ++ End termination with side and end slots meets DIN 43653 130 mm fixing centres

ULTRA Fast acting British fixing centres

A.C Voltage Voltage Rating	Max D.C. Voltage Rating Time Const. 20m secs	Normal R.M.S. Current Rating Amp.	List Number For ordering Purpose Not Incorporating Trip Indicator Fuse	Dimesnions See Fig.	
660V R.M.S also tested to 720V R.M.S	400V	16	GSG1000/16	5	
		25	GSG1000/25		
		30	GSG1000/30		
		35	GSG1000/35		
		40	GSG1000/40		
		45	GSG1000/45		
		55	GSG1000/55		
		350V	75	GSG1000/75	6
			85	GSG1000/85	
			110	GSG1000/110	
			150	GSG1000/150	
			175	GSG1000/175	
			200	GSG1000/200	4
			235	GSG1000/235	
			300	GSG1000/300	
325	GSG1000/325				
350	GSG1000/350				

勝特力材料 886-3-5753170
 勝特力电子(上海) 86-21-54151736
 勝特力电子(深圳) 86-755-83298787
[Http://www.100y.com.tw](http://www.100y.com.tw)

Trip indicator and Micro switch

A micro switch attachment is available for use with this range of trip indicator fuses & incorporates single pole change over contacts rated for 5A@250V ac & 0.4A@250V dc

Fuse	Trip Indicator Fuselinks	Mounting Kit (Code Ref)
GSA25 to 100A	TI 300	SFE9000001
GS450/150-500A	TI 300	SFE9000002
GSB25-75A	TI 600	SFE9000003
GSG 1000/25-150A/785E GSG 1000/75-150A	TI 600	SFE9000003
GSG 1000/100-500A	TI 600	SFE9000004
GSG 1000/175-350A/784E GSG 1000/235A	TI 600	SFE9000004
GSMJ 63A	TI 1200	SFE9000011
GSMJ 120-1200A/954 GSMJ400-460A/955	TI 1200	SFE9000008
GSMJ 520-680A		
GSMK 63A	TI 2000	SFE9000011
GSMK 120-1200A/954 GSMK400-460A/955		
GSMK 520-680A	TI 2000	SFE9000008

Refer figure 15 & 16

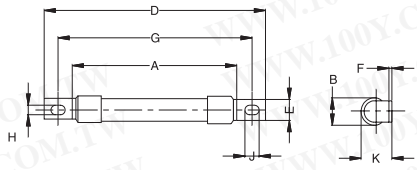

Fig. 1

Type	Rating Amp	A	B	D	E	F	G	H	J	K
GSA	5-20	28.3	8.3	46	6.35	1	37.4	3.8	5	8.1
GSB	5-20	54.7	8.3	72.4	6.35	1	63.8	3.8	5	8.1

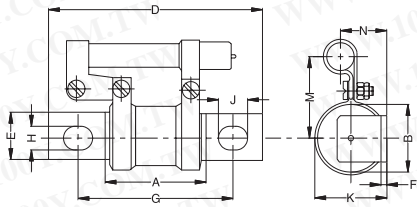

Fig. 2

Type	Rating Amp	A	B	D	E	F	G	H	J	K	M	N
GSA	25-100	29.5	17.5	58.5	12.7	1.6	43	6.5	8.1	18.2	21.8	10
GSB	25-75	50.5	18.2	80	12.7	1.6	64	6.5	8.1	18.2	21.8	10

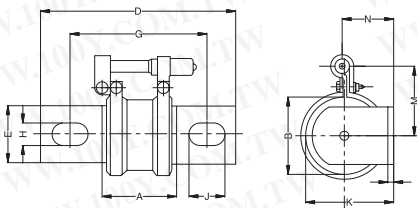

Fig. 3

Type	Rating Amp	A	B	D	E	F	G	H	J	K	M	N
GS450	150-250	34	35	85.5	25.4	3.2	60	10.3	15.9	39	30	21.5
GS1000	100-200	55.5	35	106.5	25.4	3.2	81.5	10.3	15.9	39	30	21.5

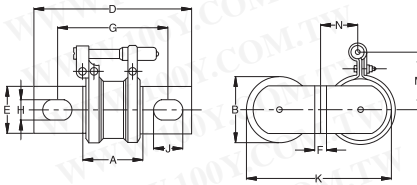

Fig. 4

Type	Rating Amp	A	B	D	E	F	G	H	J	K	M	N
GS450	300-500	34	35	85.5	25.4	6.4	60	10.3	15.8	78	30	24.5
GS1000	300-500	55.5	35	106.5	25.4	6.4	81.5	10.3	15.9	78	30	24.5
GSG1000	175-350	54	35	105	25.4	6.4	81.5	10.3	15.9	78	30	24.5

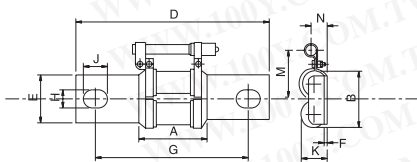

Fig. 5

Type	Rating Amp	A	B	D	E	F	G	H	J	K	M	N
GSG1000	16-55	49	17.5	78.5	12.7	1.6	64	6.5	8.1	18.2	21.8	10

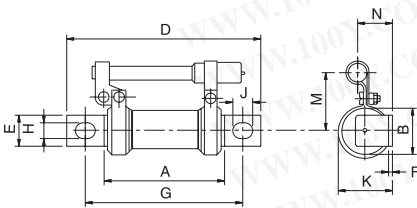

Fig. 6

Type	Rating Amp	A	B	D	E	F	G	H	J	K	M	N
GSG1000	75-150	40	35.7	94.5	31.8	1.6	74	8.3	10.9	19	31	10

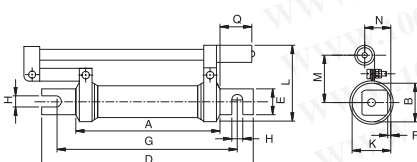

Fig. 7

Type	Rating Amp	A	B	D	E	F	G	H	K	L	M	N	Q
GSMJ	63	75	17.5	125	12	1.6	110	6.3	18.2	27.5	21.8	10	10
GSMK	63	90	17.5	145	12	1.6	130	6.3	18.2	27.5	21.8	10	10

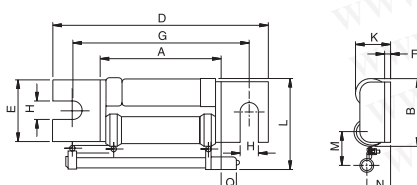

Fig. 8

Type	Rating Amp	A	B	D	E	F	G	H	K	L	M	N	Q
GSMJ	120	75	41	135	38	3.2	110	11	21	60	22.8	13	10
GSMK	120	95	41	155	38	3.2	130	11	21	60	22.8	13	10



GS Semiconductor Fuselinks

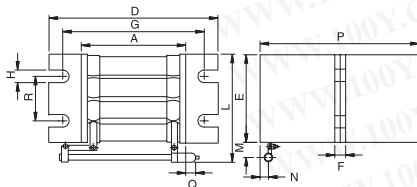
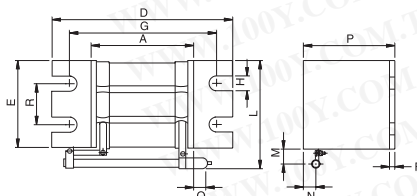
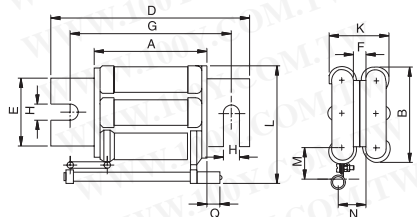
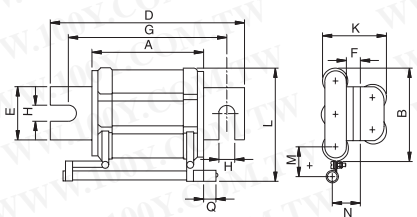
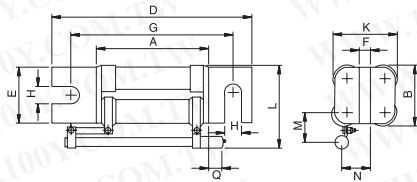
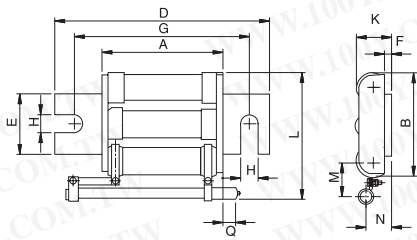

Fig. 9

Type	Rating Amp	A	B	D	E	F	G	H	K	L	M	N	Q
GSMJ	180	75	61	135	38	3.2	110	11	21	80	22.8	13	10
GSMK	180	95	61	155	38	3.2	130	11	21	80	22.8	13	10

Fig. 10

Type	Rating Amp	A	B	D	E	F	G	H	K	L	M	N	Q
GSMJ	240	75	41	135	38	6.4	110	11	42	60	22.8	16	10
GSMK	240	95	41	155	38	6.4	130	11	42	60	22.8	16	10

Fig. 11

Type	Rating Amp	A	B	D	E	F	G	H	K	L	M	N	Q
GSMJ	300	75	61	135	38	6.4	110	11	42	80	22.8	16	10
GSMK	300	95	61	155	38	6.4	130	11	42	80	22.8	16	10

Fig. 12

Type	Rating Amp	A	B	D	E	F	G	H	K	L	M	N	Q
GSMJ	350	75	61	135	38	9.6	110	11	45	80	22.8	19.5	10
GSMK	350	95	61	155	38	9.6	130	11	45	80	22.8	19.5	7

Fig. 13

Type	Rating Amp	A	D	E	F	G	H	L	M	N	P	Q	R
GSMJ	400-460	75	135	60	4.8	110	11	77	11.5	5.5	70	10	30
	520-680	77	135	80	6.3	110	11	97	11.5	5.5	90	10	40
GSMK	400-460	95	155	60	4.8	130	11	77	11.5	5.5	70	7	30
	520-680	97	155	80	6.3	130	11	97	11.5	5.5	90	7	40

Fig. 14

Type	Rating Amp	A	D	E	F	G	H	L	M	N	P	Q	R
GSMJ	800	75	135	60	9.6	110	11	77	11.5	5.5	140	10	30
	1000-1200	77	135	80	12.6	110	11	97	11.5	5.5	180	10	40
GSMK	800	95	155	60	9.6	130	11	77	11.5	5.5	140	7	30
	1000-1200	97	155	80	12.6	130	11	97	11.5	5.5	180	7	40

Fig. 15. Microswitch

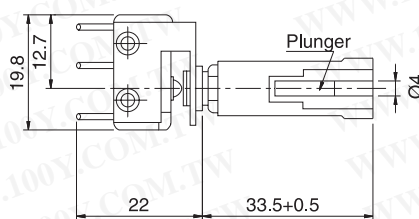
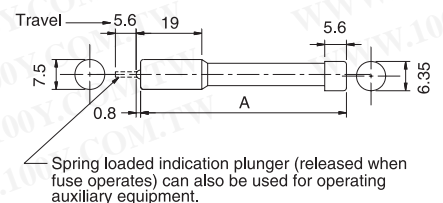

Fig. 16. Trip indicator fuses



勝特力材料 886-3-5753170
勝特力电子(上海) 86-21-54151736
勝特力电子(深圳) 86-755-83298787
[Http://www.100y.com.tw](http://www.100y.com.tw)



Application notes

for the Short - circuit Protection of Semi-Conductors by

GE Power Controls H.B.C Fuse-Links

Semi-conductor devices find application in the field of traction, distribution of power, motor drives and in process industries. In an installation these devices are normally protected in the same manner as other forms of equipment, except that emphasis is on keeping certain electrical quantities within defined limits. The survival limits of diodes and thyristors are extremely limited due to their high power-to-size ratio. The only device which seems to have adequate high response to protect them is the fast acting specially designed fuse.

Fuse - Links for the protection of Semi-Conductor Devices :

Due to very low thermal capacity of the junction, a semi-conductor is susceptible to damage immediately on the incidence of a very large overcurrent. Since a great variety of circuit conditions are obtainable, the application of the fuse requires very careful analysis of the duty and the minimum information required concerning the diodes themselves is :

- Load current
- Applied voltage
- I^2t withstand
- I peak and
- Transient over-voltage withstand.

Fuse Selection :

The major factors which determine the choice of fuse for use with a particular semi-conductor are needed to be considered with respect to a particular arrangement. The normal service condition of the semi-conductor device is first analysed. Since the individual cell is a low-power device, a number of cells are required in series and parallel for large powers. Half-wave circuits, if the maximum voltage of one cell permits, are employed, but for higher voltages, bridge circuits, with their transformers, are common.

The following Series-Parallel circuit combinations are generally in vogue:

- 1) Series connected rectifier cells, (fig. 1).

The cells are in series with the fuselink and such strings are connected in parallel in one arm of rectifier. In this arrangement correct reverse voltage distribution should be ensured.

- 2) Parallel connected rectifier cells. (fig. 2) In this arrangement, good current sharing should be ensured.

In any combination of the arrangements, the cells can fail either by over-voltage or overcurrent. Over-currents can be caused by external faults as well as internal faults such as backfire fault in one cell imposing overcurrents on healthy cells.

After the backfire fault I, the faulty cell is of no value but it is important to disconnect it to prevent accelerated damage to healthy cells.

Continuous current rating :

After determining the load current and the circuit arrangement, with semi-conductor cells, the position of fuse-links in the circuit should be determined. Thus, the maximum RMS current which will flow can be decided and the current rating of the fuse-links can be established.

Thermal rating of the semi-conductor devices as compared with energy limitation by the fuse-link in the event of an overcurrent ;

After an initial selection based on R.M.S. current rating the I^2t with stand value of the cell should be higher than the I^2t let-through value of the protective fuse corresponding to fault-clearance time.

The circuit conditions which influence the I^2t let-through value of the fuse link are prospective current and applied voltage.

i. Prospective Short Circuit Current :

The peak prospective current of the supply is usually known.

(peak asymmetrical short-circuit current- = R.M.S. Symmetrical value $\times \sqrt{2} \times 1.6$.) If this R.M.S. value is not known the same can be calculated as follows :

$$\text{Prospective current} = \frac{\text{Equipment Input load current} \times 100 \text{ A}}{\text{Supply percent Impedance}}$$

ii. Peak Inverse Voltage :

The cell survival value of peak inverse voltage should be higher than that of the corresponding protective fuselink.

From the fuse manufacturer's data on fuse-links, the I^2t value, against peak asymmetrical short-circuit current and the applied peak inverse voltage, for the selected fuse-link is read off and if this value does not exceed the I^2t of the chosen semi-conductor device, the fuse-link will protect the device.

The selection of fuse-link for an application depends very much upon the method of connection of the semi-conductor and the location of the fuse-links for their short circuit protection. This is best illustrated by examples and we shall consider a few typical arrangements in practice.

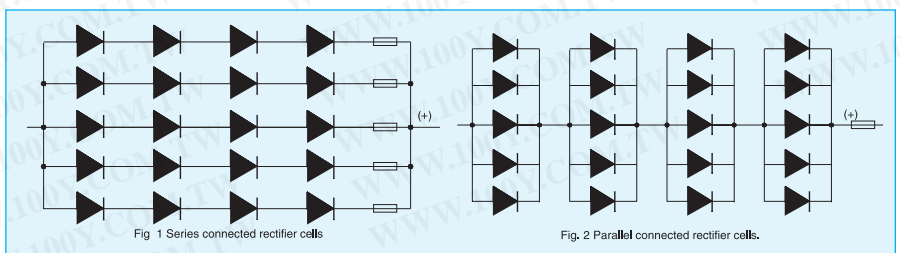

Example 1 :

A 3 phase fully controlled bridge circuit is shown in fig. 3. The particulars are

- a) Non-repetitive peak on-state current (I_{TSM}) is 1500A
- b) The I^2t withstand value of the device is 11000 A²S.
- c) Non-repetitive peak reverse voltage (V_{RSM}) is 1200V

The circuit information is as below :

- a) The incoming supply is 415V 3 phase with 5% impedance
- b) The D.C. load current is 190A
- c) One thyristor device per arm is provided.

For the type of connection

shown, the ratio $\frac{I_{rms}}{I_d} = 0.816$
 and $\frac{I_{arm}}{I_d} = 0.577$

- 1) A.C. Line Current
= $190 \times 0.816 = 155 \text{ A.}$
- 2) The arm current
= $190 \times 0.577 = 110 \text{ A.}$
- 3) The maximum fault current that is likely to flow = $155 \times 100/5 = 3100\text{A}$

Now having established the circuit and device information, select a suitable fuse - link having

- 1) The peak inverse withstand of 1000V.
- 2) A nominal rated current equal to or greater than the current flowing through the device it protects.
- 3) An I^2t let through value less than the device I^2t withstand value of 11000 A²S.
- 4) A peak cut-off current less than the device peak withstand current.

From the range of HBC fuse-links GE Power Controls for the short circuit protection of semi-conductors, type GSG1000/150A is the nearest equivalent fuse-link.

勝特力材料 886-3-5753170
 勝特力电子(上海) 86-21-54151736
 勝特力电子(深圳) 86-755-83298787
[Http://www.100y.com.tw](http://www.100y.com.tw)

3 Phase Fully Controlled Bridge Circuit

- 1) The fuse-link has a rated P.I.V. equivalent to rated P.I.V. of the device.
- 2) The 150A fuse-link has a rating matching with the line current and the nominal current rating of the device.
- 3) The I^2t let through value of GSG1000/150A fuse-link at a prospective current of 3100A at a P.I.V. of 600V is 9000 A²S which is less than the with-stand value of 11000 A²S. of the device.
- 4) The cut-off current of GSG1000/150A fuse-link at 3100 Amp. r.m.s prospective current is 2500A. The device I_{TSM} is 1500A and the peak withstand value is therefore $1500 \times 2 = 3000\text{A}$. The fuse-link will protect the device since the cut-off current of the fuse-link is only 2500A.
- 5) The peak arc voltage of GSG 1000/150A fuse-link at 415V r.m.s is 800Volts. This is less than the rated peak value of the reverse voltage of the device.

Thus for the above application GSG 1000/150A incorporated in the a.c input side of the circuit will provide short circuit protection.

If we consider GSG 1000/110A fuse-link in place of GSG 1000/150A, it will be interesting to note that the arm current in the 3 phase bridge circuit is the same as that of the fuse rating. The fuse will provide a closer degree of protection to the device.

While the GSG1000/150A fuse-link is the apt recommendation for the example under consideration, GSG1000/110A fuse-link may however be considered where the peak withstand current of the semiconductor device is still lower than the assumed value-i.e. in this example 3000A- providing of course that other considerations such as ambient temperature variations, contribution of heat by other fuse-links in service and the possible difference in the performance of the devices from designed values with their total or individual contributions, do not enhance the operating temperature of the fuse-links under normal working conditions.

Example 2 :

Consider a single phase antiparallel controller circuit shown in Fig 4

- a) Non-repetitive peak on-state current I_{TSM} is 650 A.
- b) The I^2t withstand value of the device is 2120 A²S
- c) Non-repetitive peak reverse voltage V_{RSM} is 800V.

The circuit information is as below :

- a) The incoming supply is 250V single phase a.c. with 2% impedance.
- b) The r.m.s. line current is 70A.
- c) One thyristor per arm is provided and there are two positions for accommodating the fuse-link, position A and B.

The r.m.s. current through thyristor = $70\text{A} \times 0.707 = 50\text{A}$

The maximum fault current that is likely to flow = $70 \times 100/2 = 3500\text{A}$

The first consideration will be GSG 1000/75 Amp. on the line in position A.

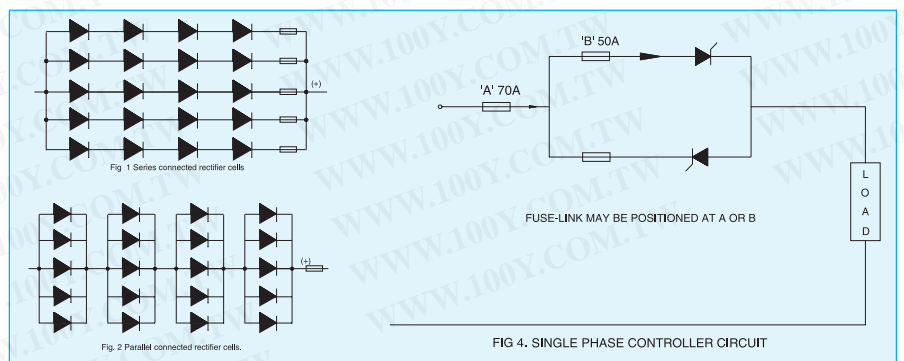

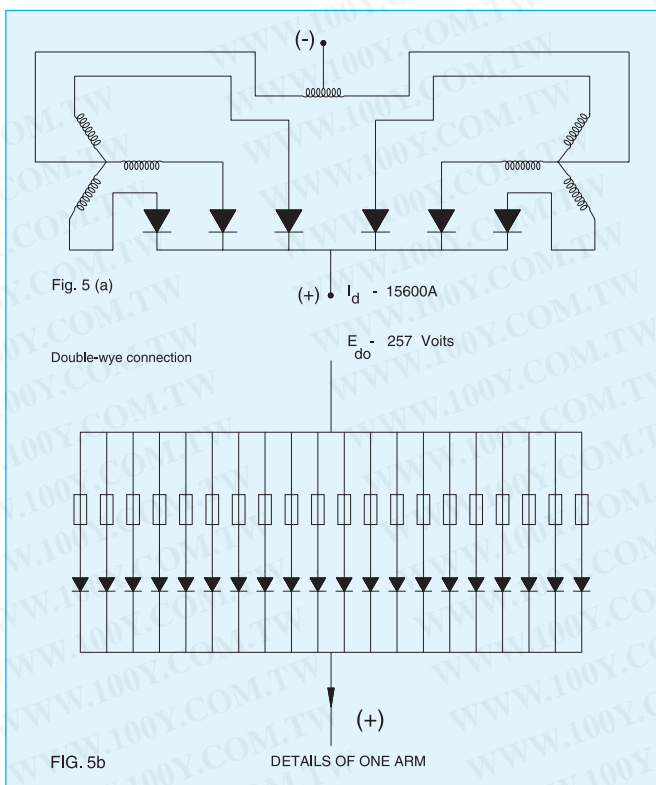

I) From the range of fuse-links from GE Power Controls GSG 1000/75A is the nearest rating for the line current of 70A.

- 1) The I^2t let through by the fuse-link at 3500A RMS fault current and 250V RMS is 1100 A²S.
- 2) The cut off current at a fault current of 3500A r.m.s. is 1400A. While the I^2t is within acceptable limits of the thyristor the cut off current exceeds $2X I_{TSM}$. The I_{TSM} value quoted by most manufacturers are known to be conservative and the factor 2 used is low. Recommendations on the basis of I^2t alone have been made and there is no known case of a fuse failing to protect, having been thus recommended.

II) Now consider two GSG1000/55A fuse-link one in series with each thyristor (position B)

- 1) The I^2t let through by the fuse-link at 3500A. r.m.s. fault current and 250V r.m.s. is 800 Amp.² Sec.
- 2) The cut-off current at 3500A r.m.s. is 1250A.
- 3) The peak arc voltage at 250V r.m.s. is 550V

The fuse-link GSG 1000/55A satisfies all requirements. Hence, the recommendation for this application, would be GSG1000/55A.

Example 3:

Let us now consider a rectifier installation, say for a caustic soda plant, the circuit for which is shown in Fig. 5 (a) and 5 (b).

A. The circuit information is

- i) Rectifier connection - double wye 3 phase
- ii) Output current (DC) $I_d = 15600A$.
- iii) The no-load a.c. voltage $E_{do} = 257V$
- iv) Protection available for the circuit is with standard air circuit breaker on input side, fuses for rectifier protection and short circuiter of incoming supply for fault in output side and overload tripping arrangement for D.C. output.

B. Transformer information: (Double wye connection)

- i) The ratio of secondary r.m.s. current (I_{rms}) in the line from the transformer to the total d.c. output current (I_d)
 i.e. $I_{rms} / I_d = 0.289$.
 therefore $I_{rms} = 15600 \times 0.289 = 4500$ Amp.
 and current per arm = 4500 Amp.
- ii) Assuming 6% impedance for transformer the maximum fault current is $4500 \times 100/6 = 75000$ Amp.

iii) The ratio of no load a.c. r.m.s. voltage (E_{rms}) line to line to no-load d.c. voltage (E_{do})

i.e. $E_{rms} / E_{do} = 1.48$
 therefore $E_{rms} = 1.48 \times 257 = 380$ Volts

iv) The ratio of average rectified current per arm (I_{av}) to the total d.c. output value (I_d)

i.e. $I_{av} / I_d = 0.167$
 therefore Mean Current per arm = $15600 \times 0.167 = 2600$ A.

C. The device information is

- i) $I_{FSM} = 5 \times 10^3$ A.
- ii) $I^2t = 153 \times 10^3$ A²S.
- iii) $V_{RSM} = 1200V$
- iv) IF (DC) = 340Amp.

To make up for the arm current of 4500 Amp. a number of cells are to be straight in parallel and for eleven or more cells the derating factor for non-uniform sharing of current in parallel paths will be 75%. Allowance of 2 strings in an arm is made so that in case of failure up to 2 strings in an arm the equipment can remain in operation until routine maintenance.

Hence number of parallel paths per arm assuming one cell

per arm = $4500 / 340 \times 0.75 + 2 = 20$

勝特力材料 886-3-5753170
勝特力电子(上海) 86-21-54151736
勝特力电子(深圳) 86-755-83298787
[Http://www.100y.com.tw](http://www.100y.com.tw)



GS Semiconductor Fuselinks

Application Data		Circuit Information						Transformer Information			Power Factor	Impedance Factor	Conduction Period	
Column Ref Number		1	2	3	4	5	6	7	8	9	10	11	12	
Abbreviations		$\frac{Erms}{Edo}$	$\frac{fr}{fs}$	$\frac{lav}{ld}$	$\frac{lrms}{ld}$	$\frac{Epr}{Edo}$	$\frac{Epr}{Erms}$	$\frac{lrms}{ld}$	$\frac{Pp}{P}$	$\frac{Ps}{P}$	PF	Z	B	
Single Phase	Half Wave Resistive or Inductive Load		2.22	1	1.0	1.57	3.14	1.41	1.57	2.47	3.5	0.405	200	180
	Full Wave Center Tap		2.22	2	0.5	0.707	3.14	2.83	0.707	1.11	1.57	0.90	200	180
	Bridge		1.11	2	0.5	0.707	1.57	1.41	1.00	1.11	1.11	0.90	200	180
Three Phase	Wye		1.48	3	0.333	0.577	2.09	2.45	0.577	1.21	1.48	0.826	191	120
	Bridge		0.74	6	0.333	0.577	1.05	2.45	0.816	1.05	1.05	0.955	200	120
	Double Wye		1.48	6	0.167	0.289	2.00	2.45	0.289	1.05	1.48	0.955	141	120
Six Phase	Star		1.48	6	0.167	0.408	1.05	2.83	0.408	1.28	1.81	0.955	58	60
	Parrallel Bridge (without IPT)		0.715	12	0.167	0.408	1.05	2.83	0.577	1.01	1.43	0.985	200	60
	Parrallel Bridge (with IPT)		0.74	12	0.167	0.289	1.05	2.83	0.408	1.01	1.05	0.985	200	120
	Series Bridge		0.37	12	0.333	0.577	1.05	2.45	0.816	1.01	1.05	0.985	200	120

勝特力材料 886-3-5753170
 勝特力电子(上海) 86-21-54151736
 勝特力电子(深圳) 86-755-83298787
[Http://www.100y.com.tw](http://www.100y.com.tw)



Silicon rectifier circuit diagrams references

Column 1 - Ratio of no load rms ac voltage (E_{rms}) (line-to-line) to no-load dc voltage (E_{do}). The no-load dc voltage is given approximately by :

$$E_{do} = (E_d + nE_f) \left\{ 1 + \frac{X_1}{Z} + \frac{R}{100} \right\}$$

Where E_d = full load D.C. voltage

E_f = Forward voltage drop

n - number of devices in series per arm (half wave)

or

2X number of devices in series per arm (bridge)

R = Percent resistive drop in transformer

X_1 = percent reactive drop in transformer

Z = impedance factor given, in column 11

Note - Busbars, saturable reactors, tap changers and system impedance, may increase both the resistive and reactive voltage drop.

Column 2 - Ratio of dc ripple frequency (f_r) over the line frequency (f_s)

Note - The overlap (high commutating reactance) increases the ripple voltage. Phase control also increases the ripple voltage substantially.

Column 3 - Ratio of average rectified dc (I_{av}) per arm to the total D.C. output current (I_d).

Column 4 - Ratio of rms current (I_{rms}) per arm to the total D.C. output current (I_d).

Note - Fuses are dimensioned for rms current.

Column 5 - Ratio of the reverse voltage across the rectifier (E_{pr}) to the no-load D.C. voltage E_{do} .

Column 6 - Ratio of the reverse voltage across the rectifier (E_{pr}) to the secondary rms voltage (E_{rms}) across the transformer leg.

Column 7 - Ratio of the secondary rms current (I_{rms}) in the line from the transformer to the total D.C. output current (I_d).

Note - Fuses in the A.C. leads of bridge rectifiers must be dimensioned for this secondary current.

Column 8 - Ratio of the primary rated power (P_p) of the rectifier transformer to the ideal output power (P) of the rectifier. This power is given by $P = I_{dc} \times E_{do}$. This value is used for fault current calculation.

Column 9 - Ratio of the secondary rated power (P_r) of the rectifier transformer to the ideal out-put power (P) of the rectifier (see column 8). This indicates the frame size required.

Column 10 - Maximum obtainable power factor Ratio of the apparent power (in KVA) to the real power (in KW) in the primary of the transformer. Overlap and phase control reduce the power factor to a value below this maximum.

Column 11 - The impedance factor needed to calculate voltage drop.

Column 12 - The conduction period

勝特力材料 886-3-5753170
勝特力电子(上海) 86-21-54151736
勝特力电子(深圳) 86-755-83298787
[Http://www.100y.com.tw](http://www.100y.com.tw)



D) Selection of fuse for diode protection

The actual current in a string assuming failure of two cells $4500/18 \times 0.75 = 333A$.

Fault current/string = $75000/18 \times 0.75 = 5550A$.

Considering GS 1000/400A in series with each cell, the I^2t value at 5550A. R.M.S. and 540 V p.i.v. = 150000 A²S.

The cut-off current at 5550A = 7.5×10^3 A.

Case 1 : Fault on D.C. busbars :

Disregarding the drop in rectifier, the fault current can be assumed to be 75000A (restricted only by the percentage impedance of the transformer) Fault current per string in an arm = $75000/18 \times 0.75 = 5550A$.

From values for fuse-link it can be seen that the GS1000/400 A. fuse will protect the diode.

However, for a fault on the D.C. busbars, the short circuiter will short circuit the input before the rectifier thereby allowing the breaker on the input side to operate. The normal time of operation for a short circuiter is of the order of 2 milliseconds.

The I^2t let through for 2 milliseconds (time taken by short circuiter) with a fault current of 5550A r.m.s.

$$= \int_0^{0.002} (5550 \times \sqrt{2})^2 \sin^2 \omega t dt$$
$$= 14.6 \times 10^6 \text{ A}^2\text{S.}$$

The pre-arcing I^2t of the GS1000/400A fuse-link is $60 \times 10^3 \text{ A}^2\text{S}$.

Since total $I^2t = I^2t$ for each cell x (no. of cells in parallel)² = $(60 \times 10^3) \times (20)^2 = 24 \times 10^6 \text{ A}^2\text{S}$.

(*assuming all fuses in 20 parallel paths are intact)

The I^2t let through by the short circuiter is less than the pre-arcing I^2t of the fuse combination and hence the operation of fuse-links for this condition is not warranted.

Case 2 : Backfire fault :

I^2t let through by one fuse in series with faulty cell at 75000 A. 540 P.I.V. (380V r.m.s.) = 350000 A²S. This I^2t is shared by 18 cells in the return arm during the period of conduction. Hence the I^2t let through each string.

$$= 350000 / (18)^2 = 1.8 \times 10^3 \text{ A}^2\text{S.}$$

The above value is considerably less than the pre-arcing I^2t for GS 1000/400 Amp. ($60 \times 10^3 \text{ A}^2\text{S}$.) and hence only the fuse in series with the faulty cell will operate.

The characteristics of the selected fuse-link may have to be co-ordinated with characteristics of other devices for overload protection and where a fuse-link is required for overload protection also, a suitable fuse-link may be selected by co-ordination of time current characteristics and cell-survival characteristics.

As a large number of circuit configurations are used in practice and since in the application of fuse-links the circuit details form the basis for a co-ordinated fuse selection, the most common configurations and the relationships of associated parameters are furnished in the

table given. The choice of the appropriate fuse-link depends on the completeness of the circuit and device information for a particular application.

Other considerations affecting the rating of fuse-link :

1) **Ambient temperature** : The effect of ambient temperature on the current rating of the fuse-link is pronounced when the maximum end cap temperature permissible is exceeded and in such cases derating of the fuse-link becomes necessary. A derating factor is usually applied on the standard rating. A thumb rule of 1% deration for every °C rise above 35°C ambient will give the deration on the standard rating whose end cap temperature is equal to 110°C. This deration will give a safe working temperature on the end cap.

2) **Enclosure** : The standard ratings of the fuse-links are normally *free air* ratings. If the fuses are installed in an enclosure, the temperature of the enclosure is likely to be higher. For instance in an 40°C ambient if the fuses are in an enclosure the temperature of the enclosure is likely to be of the order of 55°C with reasonable ventilation.

This means that fuse-links which have an end cap temperature rise of 55°C in open air will have to be derated when installed in an enclosure. Further deration may be needed if the enclosure is completely sealed and also incorporates components which produce heat due to the passage of current. Alternatively, if forced ventilation is adopted uprating of the fuse is also possible.

3) **Pulsing** : Where continous current duty is involved the basis of rating the fuse on RMS current is satisfactory. On the other hand where the duty involves a specific duty cycle in terms of a few cycles or even one half of a cycle of a sine wave, further checks will have to be made to ensure that the fuse selected on the basis of continuous rating will give performance without deterioration. The following considerations are important in selecting the fuselink.

i) The RMS value of the current during the duty cycle (comprising ON/OFF periods) must not exceed the current rating of the fuse-link.

ii) the RMS value of the current during ON time must not exceed 50% of the RMS current which would cause the fuse to operate for the same ON time.

iii) If the pulse is less than 10 milliseconds then the I^2t value of the pulse should not be greater than 50% of the short circuit pre-arcing I^2t value shown in the published fuse characteristics.

The foregoing considerations applied to the standard fuse rating may result in a higher rated fuse-link to be chosen. In all such cases, a second check to ensure that the fault let-through values by the fuse-link do not exceed the limiting values of the semiconductor devices for safe operation.

勝特力材料 886-3-5753170
勝特力电子(上海) 86-21-54151736
勝特力电子(深圳) 86-755-83298787
Http://www.100y.com.tw