

# DUO series Contactors

## SC-E series

勝特力材料 886-3-5753170  
 勝特力电子(上海) 86-21-34970699  
 勝特力电子(深圳) 86-755-83298787  
[Http://www.100y.com.tw](http://www.100y.com.tw)

### SC-E series magnetic contactors/non-reversing

#### ■ Features

- Models SC-E02 to SC-E4 have 3-pole main circuits and come in three sizes with widths of 43mm (up to 25A), 54mm (up to 50A), and 67mm (up to 80A).
- Models SC-E1 to SC-E7 employ a box type terminal that allows wires to be connected directly to the main circuit.
- Equipped with a finger-protection terminal structure (IP20) that prevents accidental finger touch to live parts.
- Models SC-E5 to SC-E7 use a SUPER MAGNET (AC/DC-input/DC-operate) to achieve high operating reliability.



#### ■ Standards

IEC 60947-4-1, EN 60947-4-1, VDE 0660, JIS C 8201-4-1  
 UL 508, CSA C22.2

#### ■ Ordering information

Specify the following:

1. Type number
2. Operating coil order voltage (See page 02/51)

#### ■ Type number nomenclature

##### SC-E02 P / G

###### Operating coil voltage

- Blank: AC operated (E02 to E4)  
 AC/DC operated (E5 to E7)
- G: DC operated (E02 to E4)

###### Wiring

- Blank: Straight wiring connection
- P: Ring terminal connection

###### Frame size

02 to E7

#### ■ Accessories

A full range of accessories with the emphasis on utility.

##### Contactors: SC-E series

##### Thermal overload relays: TK-E series

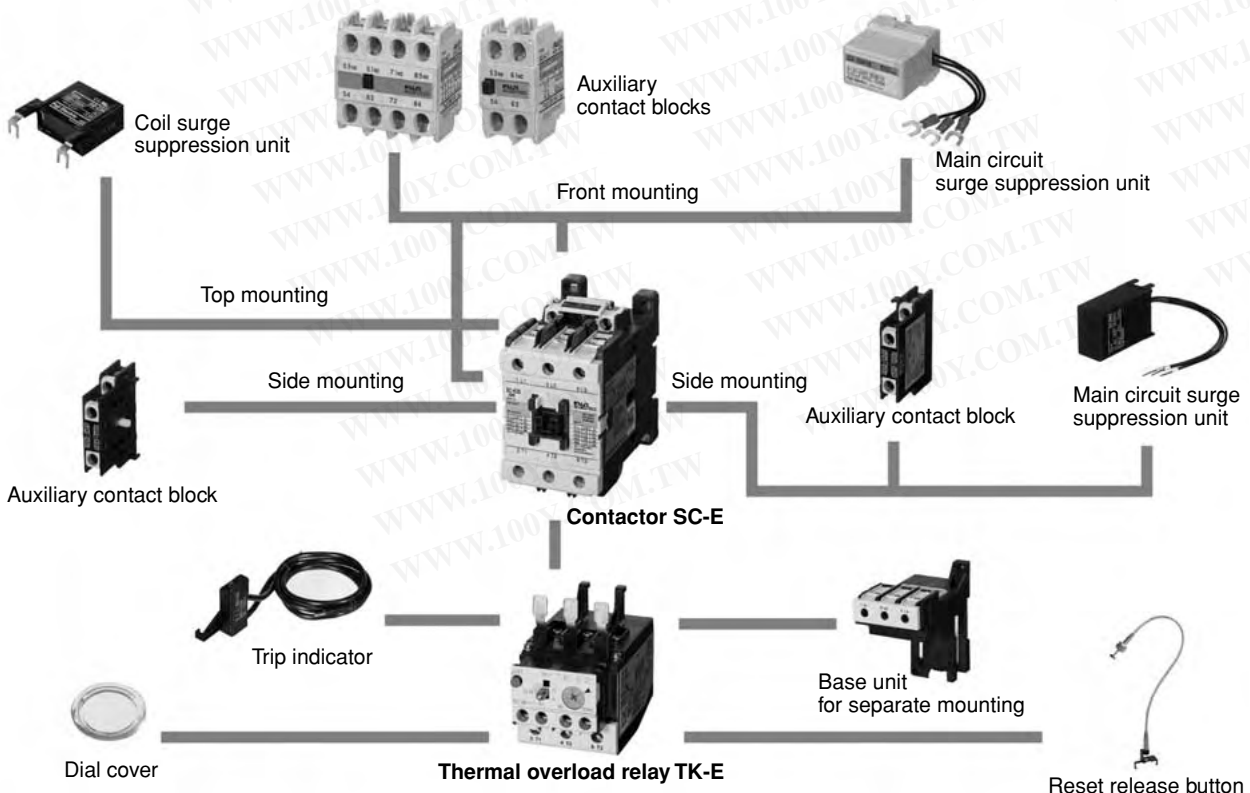

■ Types and ratings

Operating coil	Max. motor capacity (kW)				Rated operating current (A)						Rated thermal current (A)	Aux. contact arrangement	Contactor type
	3-phase AC-3				3-phase AC-3				Resistive load AC-1				
	200 240V	380 440V	500 550V	600 690V	200 240V	380 440V	500 550V	600 690V	200 240V	380 440V			
AC operated	2.2	4	4	4	9	9	7	5	20	20	20	—	SC-E02
	3	5.5	5.5	5.5	12	12	9	7	20	20	20	—	SC-E03
	4	7.5	7.5	7.5	18	18	13	9	25	25	25	—	SC-E04
	5.5	11	11	7.5	25	25	17	9	32	32	32	—	SC-E05
	7.5	15	15	11	32	32	24	15	50	50	50	—	SC-E1
	11	18.5	18.5	15	40	40	29	19	60	60	60	—	SC-E2
	15	22	25	22	50	50	38	26	65	65	65	—	SC-E2S
	18.5	30	37	30	68	65	60	38	100	100	100	—	SC-E3
AC/DC operated	22	40	37	37	80	80	60	44	105	105	105	—	SC-E4
	30	55	55	55	105	105	85	64	150	150	150	2NO+2NC	SC-E5
	37	60	60	60	125	125	90	72	150	150	150	2NO+2NC	SC-E6
DC operated	45	75	75	90	150	150	120	103	200	200	200	2NO+2NC	SC-E7
	2.2	4	4	4	9	9	7	5	20	20	20	—	SC-E02/G
	3	5.5	5.5	5.5	12	12	9	7	20	20	20	—	SC-E03/G
	4	7.5	7.5	7.5	18	18	13	9	25	25	25	—	SC-E04/G
	5.5	11	11	7.5	25	25	17	9	32	32	32	—	SC-E05/G
	7.5	15	15	11	32	32	24	15	50	50	50	—	SC-E1/G
	11	18.5	18.5	15	40	40	29	19	60	60	60	—	SC-E2/G
	15	22	25	22	50	50	38	26	65	65	65	—	SC-E2S/G
	18.5	30	37	30	68	65	60	38	100	100	100	—	SC-E3/G
	22	40	37	37	80	80	60	44	105	105	105	—	SC-E4/G

Note :Ratings conform to IEC 60947-4-1

■ Performance data

Frame size	Making current (A)		Breaking current (A)		Operating cycles per hour	Durability (operations)	
	220V	440V	220V	440V		Electrical	Mechanical
SC-E02	108	108	90	90	1800	2 million	10 million
SC-E03	144	144	120	120	1800	1.5 million	10 million
SC-E04	216	216	180	180	1800	1.5 million	10 million
SC-E05	250	250	200	200	1200	1.5 million	10 million
SC-E1	384	384	320	320	1200	1.5 million	10 million
SC-E2	480	480	400	400	1200	1.5 million	10 million
SC-E2S	500	500	400	400	1200	1.5 million	10 million
SC-E3	816	780	680	650	1200	1.5 million	5 million
SC-E4	816	800	680	650	1200	1 million	5 million
SC-E5	1260	1260	1050	1050	1200	1 million	5 million
SC-E6	1500	1500	1250	1250	1200	1 million	5 million
SC-E7	1800	1800	1500	1500	1200	1 million	5 million

# DUO series Contactors

## SC-E series

### SC-E series magnetic contactors/reversing

#### ■ Features

- Ideal for the forward-reverse operation of 3-phase motors or plugging stops.
- Mechanical interlock
- Snap-on mounting to 35mm-wide top hat rail (DIN). (E02 to E4)

#### ■ Type number nomenclature

##### SC-E2RM/G

#### Operating coil voltage

- Blank: AC operated (E02 to E4)  
 AC/DC operated (E5 to E7)  
 G: DC operated (E02 to E4)

#### Frame size

02 to E7



#### ■ Ordering information

Specify the following:

1. Type number
2. Operating coil order voltage (See page 02/51)
3. Auxiliary contact arrangement

#### ■ Types and ratings

Operating coil	Max. motor capacity (kW)				Rated operating current (A)				Rated thermal current (A)	Aux. contact arrangement	Contactor type		
	3-phase AC-3				3-phase AC-3							Resistive load AC-1	
	200 240V	380 440V	500 550V	600 690V	200 240V	380 440V	500 550V	600 690V				200 240V	380 440V
AC operated	2.2	4	4	4	9	9	7	5	20	20	20	(1NO+1NC) × 2, 2NC × 2	SC-E02RM*1
	3	5.5	5.5	5.5	12	12	9	7	20	20	20	(1NO+1NC) × 2, 2NC × 2 (3NO+1NC) × 2, (2NO+2NC) × 2	SC-E03RM*1
	4	7.5	7.5	7.5	18	18	13	9	25	25	25	(1NO+1NC) × 2, 2NC × 2 (3NO+1NC) × 2, (2NO+2NC) × 2	SC-E04RM*1
	5.5	11	11	7.5	25	25	17	9	32	32	32	(1NO+1NC) × 2, 2NC × 2 (3NO+1NC) × 2, (2NO+2NC) × 2	SC-E05RM*1
	7.5	15	15	11	32	32	24	15	50	50	50	(1NO+1NC) × 2, 2NC × 2 (3NO+1NC) × 2, (2NO+2NC) × 2	SC-E1RM*1
	11	18.5	18.5	15	40	40	29	19	60	60	60	(1NO+1NC) × 2, 2NC × 2 (3NO+1NC) × 2, (2NO+2NC) × 2	SC-E2RM*1
	15	22	25	22	50	50	38	26	65	65	65	(1NO+1NC) × 2, 2NC × 2 (3NO+1NC) × 2, (2NO+2NC) × 2	SC-E2SRM*1
	18.5	30	37	30	68	65	60	38	100	100	100	(1NO+1NC) × 2, 2NC × 2 (3NO+1NC) × 2, (2NO+2NC) × 2	SC-E3RM*1
	22	40	37	37	80	80	60	44	105	105	105	(1NO+1NC) × 2, 2NC × 2 (3NO+1NC) × 2, (2NO+2NC) × 2	SC-E4RM*1
AC/DC operated	30	55	55	55	105	105	85	64	150	150	150	(2NO+2NC) × 2	SC-E5RM
	37	60	60	60	125	125	90	72	150	150	150	(2NO+2NC) × 2	SC-E6RM
	45	75	75	90	150	150	120	103	200	200	200	(2NO+2NC) × 2	SC-E7RM

Notes: • Ratings conform to IEC 60947-4-1

- \*1 The above types are shipped in a set containing two magnetic contactors, one SZ-RM mechanical interlock unit, two front mounting auxiliary contact blocks, and electrical interlock wiring. The power connection kit for the reversing contactor is sold separately.
- To prevent short-circuit faults when using SC-E02R to SC-E04RM types for high-speed switching, provide a time delay relay or other electrical interlock to ensure that the switching time is 15ms min.
- For combined use with an MMS, instead of ordering a reversing type, order and assemble the individual components (two magnetic contactors, one SZ-RM mechanical interlock unit, two auxiliary contact blocks, and the power connection kit (SZ-ERW□/A, SZ-ERW□/B)).
- \*1 Equipped with the SZ-A11/T, SZ-A02/T, SZ-A31/T, or SZ-A22/T front mounting auxiliary contact block.

• For motor starter use, order the power connection kit and thermal overload relay.

Type	TOR
SC-E02RM to SC-E05RM	TK-E02
SC-E1RM to SC-E2SRM	TK-E2
SC-E3RM to SC-E4RM	TK-E3
SC-E5RM to SC-E7RM	TK-E6H

■ Types and ratings

Operating coil	Max. motor capacity (kW)				Rated operating current (A)				Rated thermal current (A)	Aux. contact arrangement	Contactor type		
	3-phase AC-3				3-phase AC-3							Resistive load AC-1	
	200	380	500	600	200	380	500	600	200	380			
	240V	440V	550V	690V	240V	440V	550V	690V	240V	440V			
DC operated	2.2	4	4	4	9	9	7	5	20	20	20	(1NO+1NC) × 2, 2NC × 2 (3NO+1NC) × 2, (2NO+2NC) × 2	SC-E02RM/G*1
	3	5.5	5.5	5.5	12	12	9	7	20	20	20	(1NO+1NC) × 2, 2NC × 2 (3NO+1NC) × 2, (2NO+2NC) × 2	SC-E03RM/G*1
	4	7.5	7.5	7.5	18	18	13	9	25	25	25	(1NO+1NC) × 2, 2NC × 2 (3NO+1NC) × 2, (2NO+2NC) × 2	SC-E04RM/G*1
	5.5	11	11	7.5	25	25	17	9	32	32	32	(1NO+1NC) × 2, 2NC × 2 (3NO+1NC) × 2, (2NO+2NC) × 2	SC-E05RM/G*1
	7.5	15	15	11	32	32	24	15	50	50	50	(1NO+1NC) × 2, 2NC × 2 (3NO+1NC) × 2, (2NO+2NC) × 2	SC-E1RM/G*1
	11	18.5	18.5	15	40	40	29	19	60	60	60	(1NO+1NC) × 2, 2NC × 2 (3NO+1NC) × 2, (2NO+2NC) × 2	SC-E2RM/G*1
	15	22	25	22	50	50	38	26	65	65	65	(1NO+1NC) × 2, 2NC × 2 (3NO+1NC) × 2, (2NO+2NC) × 2	SC-E2SRM/G*1
	18.5	30	37	30	68	65	60	38	100	100	100	(1NO+1NC) × 2, 2NC × 2 (3NO+1NC) × 2, (2NO+2NC) × 2	SC-E3RM/G*1
	22	40	37	37	80	80	60	44	105	105	105	(1NO+1NC) × 2, 2NC × 2 (3NO+1NC) × 2, (2NO+2NC) × 2	SC-E4RM/G*1

Notes: • Ratings conform to IEC 60947-4-1

- \*1 The above types are shipped in a set containing two magnetic contactors, one SZ-RM mechanical interlock unit, two front mounting auxiliary contact blocks, and electrical interlock wiring. The power connection kit for the reversing contactor is sold separately.
- To prevent short-circuit faults when using SC-E02R/G to SC-E04RM/G types for high-speed switching, provide a time delay relay or other electrical interlock to ensure that the switching time is 15ms min.
- For combined use with an MMS, instead of ordering a reversing type, order and assemble the individual components (two magnetic contactors, one SZ-RM mechanical interlock unit, two auxiliary contact blocks, and the power connection kit (SZ-ERW□/A, SZ-ERW□/B).
- \*1 Equipped with the SZ-A11/T, SZ-A02/T, SZ-A31/T, or SZ-A22/T front mounting auxiliary contact block.

• For motor starter use, order the power connection kit and thermal overload relay.

Type	TOR
SC-E02RM/G to SC-E05RM/G	TK-E02
SC-E1RM/G to SC-E2SRM/G	TK-E2
SC-E3RM/G to SC-E4RM/G	TK-E3
SC-E5RM/G to SC-E7RM/G	TK-E6H

■ Performance data

Frame size	Making current (A)		Breaking current (A)		Operating cycles per hour	Durability (operations)	
	220V	440V	220V	440V		Electrical	Mechanical
SC-E02	108	108	90	90	1800	2 million	10 million
SC-E03	144	144	120	120	1800	1.5 million	10 million
SC-E04	216	216	180	180	1800	1.5 million	10 million
SC-E05	250	250	200	200	1200	1.5 million	10 million
SC-E1	384	384	320	320	1200	1.5 million	10 million
SC-E2	480	480	400	400	1200	1.5 million	10 million
SC-E2S	500	500	400	400	1200	1.5 million	10 million
SC-E3	816	780	680	650	1200	1.5 million	5 million
SC-E4	816	800	680	650	1200	1 million	5 million
SC-E5	1260	1260	1050	1050	1200	1 million	5 million
SC-E6	1500	1500	1250	1250	1200	1 million	5 million
SC-E7	1800	1800	1500	1500	1200	1 million	5 million

# DUO series Contactors

## SC-E series

### SC-E series contactors, ring terminal connection types

#### ■ Features

- The new type allows wiring with ring crimp terminals in addition to the conventional straight wiring connection. Types SC-E02P to SC-E2SP also enable straight wiring connection.
- A new slide-type terminal cover is easy to mount and remove. Up to two ring crimp terminals can be connected from the upper terminal part.
- Three module designs with widths of 43mm (up to 25A), 54mm (up to 50A), and 67mm (up to 80A) provide an ideal combination with manual motor starters for ring terminal connection.
- UL, CSA (cUL) approval is pending.



#### ■ Types and rings

##### • Magnetic contactors

Operating coil	Max. motor capacity (kW)		Rated operational current (A)				Rated thermal current (A)	Aux. contact arrangement	Type
	3-phase AC-3		3-phase AC-3		3-phase AC-1				
	200V	380V	200V	380V	200V	380V			
	240V	440V	240V	440V	240V	440V			
AC operated	2.2	4	9	9	20	20	20	—	SC-E02P
	3	5.5	12	12	20	20	20	—	SC-E03P
	4	7.5	18	18	25	25	25	—	SC-E04P
	5.5	11	25	25	32	32	32	—	SC-E05P
	7.5	15	32	32	50	50	50	—	SC-E1P
	11	18.5	40	40	60	60	60	—	SC-E2P
	15	22	50	50	65	65	65	—	SC-E2SP
	18.5	30	68	65	100	100	100	—	SC-E3P
DC operated	2.2	4	9	9	20	20	20	—	SC-E02P/G
	3	5.5	12	12	20	20	20	—	SC-E03P/G
	4	7.5	18	18	25	25	25	—	SC-E04P/G
	5.5	11	25	25	32	32	32	—	SC-E05P/G
	7.5	15	32	32	50	50	50	—	SC-E1P/G
	11	18.5	40	40	60	60	60	—	SC-E2P/G
	15	22	50	50	65	65	65	—	SC-E2SP/G
	18.5	30	68	65	100	100	100	—	SC-E3P/G
	22	40	80	80	105	105	105	—	SC-E4P/G

##### • Thermal overload relays

Applicable contactor	Type	Auxiliary contact arrangement	Trip category (JIS) Resistive load AC-1	No. of heater elements
Non-reversing SC-E02P, E02P/G SC-E03P, E03P/G SC-E04P, E04P/G SC-E05P, E05P/G	TK-E02	1NO+1NC	10A	3
SC-E1P, E1P/G SC-E2P, E2P/G SC-E2SP, E2SP/G	TK-N2/T	1NO+1NC	10A	3
SC-E3P, E3P/G SC-E4P, E4P/G	TK-N3/T	1NO+1NC	10A	3

• **Coil characteristics:** See page 02/53

• **dimensions:** See page 02/58

■ Operating coil

• AC coil, SC-E02 to SC-E4

Order voltage	Coil operating voltage and frequency
<b>AC24V</b>	24V AC 50Hz / 24–26V AC 60Hz
<b>AC48V</b>	48V AC 50Hz / 48–52V AC 60Hz
<b>AC100V</b>	100V AC 50Hz / 100–110V AC 60Hz
<b>AC110V</b>	100–110V AC 50Hz / 110–120V AC 60Hz
<b>AC120V</b>	110–120V AC 50Hz / 120–130V AC 60Hz
<b>AC200V</b>	200V AC 50Hz / 200–220V AC 60Hz
<b>AC220V</b>	200–220V AC 50Hz / 220–240V AC 60Hz
<b>AC240V</b>	220–240V AC 50Hz / 240–260V AC 60Hz
<b>AC380V</b>	346–380V AC 50Hz / 380–420V AC 60Hz
<b>AC400V</b>	380–400V AC 50Hz / 400–440V AC 60Hz
<b>AC440V</b>	415–440V AC 50Hz / 440–480V AC 60Hz
<b>AC500V</b>	480–500V AC 50Hz / 500–550V AC 60Hz

Note: Other voltages are available in 24 to 600V AC on request.

• DC coil, SC-E02/G to SC-E4/G

Order voltage	Coil operating voltage
<b>DC12V</b>	12V DC
<b>DC24V</b>	24V DC
<b>DC48V</b>	48V DC
<b>DC60V</b>	60V DC
<b>DC100V</b>	100V DC
<b>DC110V</b>	110V DC
<b>DC120V</b>	120V DC
<b>DC200V</b>	200V DC
<b>DC210V</b>	210V DC
<b>DC220V</b>	220V DC

Note: Other voltages are available in 12 to 250V DC on request.

• AC/DC coil (SUPER MAGNET), SC-E5 to SC-E7

Order voltage	Coil operating voltage and frequency
<b>24V</b>	24–25V AC 50/60Hz, 24V DC
<b>48V</b>	48–50V AC 50/60Hz, 48V DC
<b>100V</b>	100–127V AC 50/60Hz, 100–120V DC *1
<b>200V</b>	200–250V AC 50/60Hz, 200–240V DC *2
<b>400V</b>	380–450V AC 50/60Hz
<b>500V</b>	460–575V AC 50/60Hz

Notes: • Other voltages are available in 24 to 575V AC (24 to 240V DC) on request.

\*1 The coil voltage from DC power supply with single-phase full-wave rectification will be 100–110V.

\*2 The coil voltage from DC power supply with single-phase full-wave rectification will be 200–220V.

■ Coil characteristics

• AC operated

Frame size	Power consumption (VA)		Power loss (W)		Pick-up voltage (V)		Drop-out voltage (V)		Operating time (ms)	
	Inrush	Sealed	200V	220V	200V	220V	200V	220V	Coil ON →	Coil OFF →
	200V 50Hz	200V 50Hz	50Hz	60Hz	50Hz	60Hz	50Hz	60Hz	Contact ON	Contact OFF
E02 to E05	90	9	2.7	2.8	105–136	116–146	75–106	88–120	9–20	5–16
E1 to E2S	120	12.7	3.6	3.8	110–130	120–140	75–105	85–115	10–17	6–13
E3, E4	180	13.3	4.5	5	115–135	130–150	85–110	100–125	10–18	8–18
E5	80	4	3.2	3.6	140–150	140–150	60–100	60–100	39–45	27–33
E6, E7	190	4.9	3.4	3.7	140–150	140–150	60–100	60–100	31–37	30–36

• DC operated

Frame size	Power consumption (W)		Time constant (ms)	Pick-up voltage (V)	Drop-out voltage (V)	Operating time (ms)	
	Inrush	Sealed				Coil ON →	Coil OFF →
	200V	200V	Sealed	200V DC	200V DC	Contact ON	Contact OFF
E02/G to E05/G	7	7	50	92–130	30–60	45–49	10–26
E1/G to E2S/G	9	9	60	80–120	30–70	40–50	8–17
E3/G, E4/G	12	12	70	80–120	24–60	60–70	14–21
E5	90	2.8	1	140–160	40–100	35–41	26–32
E6, E7	225	3.2	1	140–160	40–100	28–34	27–33

# DUO series Contactors

## SC-E series

### ■ Auxiliary contact ratings

Based on IEC 60974-4-1, EN 60947-4-1, JIS C 8201-4-1

Frame size	Rated insulation voltage (V)	Rated thermal current (A)	Making and breaking capacity at AC (A)		Rated operational current (A)				Minimum operating voltage and current
					AC Voltage	AC-15 Ind. load	DC Voltage	DC-13 Ind. load	
E02 to E4 E02/G to E4/G	–	–	–	–	–	–	–	–	–
E5 to E7	690	10	120V 60 220V 30 440V 15 600V 12	60 30 15 12	120V 6 220V 3 440V 1.5 600V 1.2	6 3 1.5 1.2	24V 3 48V 1.5 110V 0.55 220V 0.27	3 1.5 0.55 0.27	5V DC, 3mA

### ■ Types and ratings for UL and CSA

Operating coil	Rated insulation voltage (V)	Max. motor capacity (Hp)				Rated operating current (A)				Rated thermal current (A)	Type
		3-phase motor				3-phase motor					
		200V	220 240V	400 480V	550 600V	200V	220 240V	400 480V	550 600V		
AC operated	600	2	2	5	5	7.8	6.8	7.6	6.1	20	SC-E02
		3	3	7.5	7.5	11	9.6	11	9	20	SC-E03
		5	5	10	10	17.5	15.2	14	11	25	SC-E04
		5	7.5	15	15	17.5	22	21	17	32	SC-E05
		7.5	10	25	25	25.3	28	34	27	50	SC-E1
		10	15	30	30	32.2	42	40	32	60	SC-E2
		15	20	30	30	48.3	54	40	32	65	SC-E2S
		20	25	50	50	62.1	68	65	52	100	SC-E3
AC/DC operated	600	25	30	50	50	78.2	80	65	52	105	SC-E4
		30	30	60	75	92	80	77	77	150	SC-E5
		40	40	75	100	119.6	104	96	99	150	SC-E6
DC operated	600	50	50	100	125	149.5	130	124	125	200	SC-E7
		2	2	5	5	7.8	6.8	7.6	6.1	20	SC-E02/G
		3	3	7.5	7.5	11	9.6	11	9	20	SC-E03/G
		5	5	10	10	17.5	15.2	14	11	25	SC-E04/G
		5	7.5	15	15	17.5	22	21	17	32	SC-E05/G
		7.5	10	25	25	25.3	28	34	27	50	SC-E1/G
		10	15	30	30	32.2	42	40	32	60	SC-E2/G
15	20	30	30	48.3	54	40	32	65	SC-E2S/G		
20	25	50	50	62.1	68	65	52	100	SC-E3/G		
25	30	50	50	78.2	80	65	52	105	SC-E4/G		

### ■ Auxiliary contact ratings for UL and CSA

Frame size	Rated insulation voltage (V)	Rated thermal current (A)	Making and breaking current (A)							
			AC (rating code A600)			DC (rating code Q300)				
			Voltage	Making	Breaking	Voltage	Making	Breaking		
E02 to E4 E02/G to E4/G	–	–	–	–	–	–	–	–	–	–
E5 to E7	600	10	120V 60 240V 30 480V 15 600V 12	60 30 15 12	6 3 1.5 1.2	125V 0.55 250V 0.27	0.55 0.27	0.55 0.27		

■ Electrical durability

• AC-3 duty / SC-E02 to SC-E05

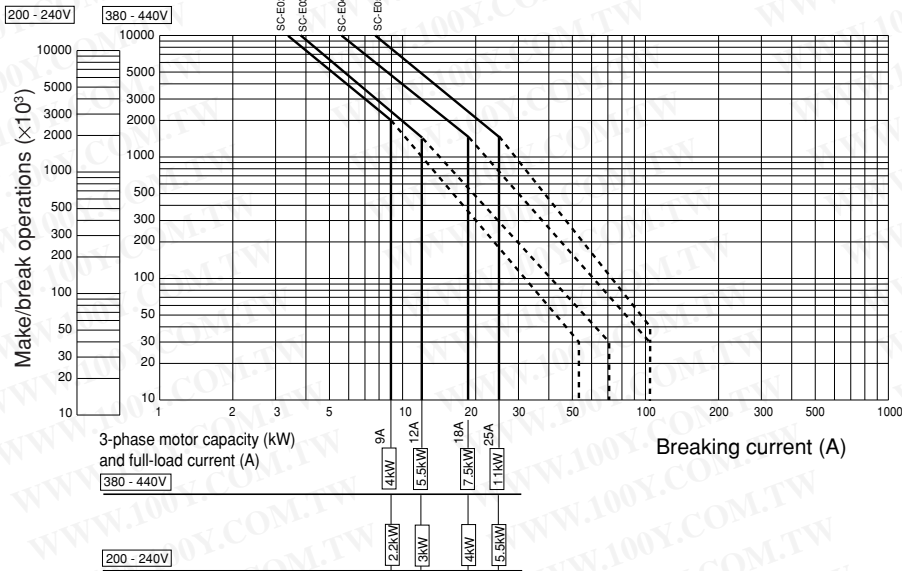

• AC-3 duty / SC-E1 to SC-E7

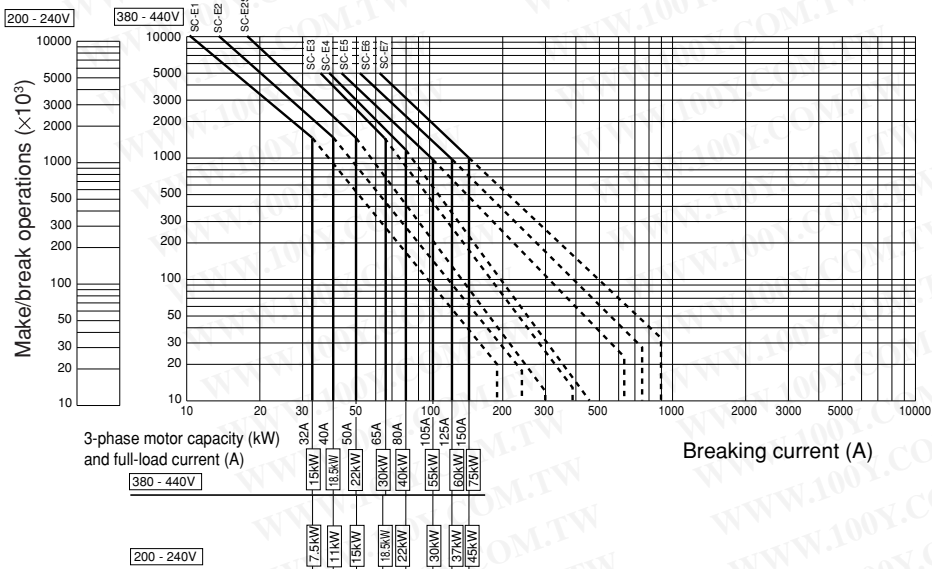

• AC-1 duty / SC-E02 to SC-E7

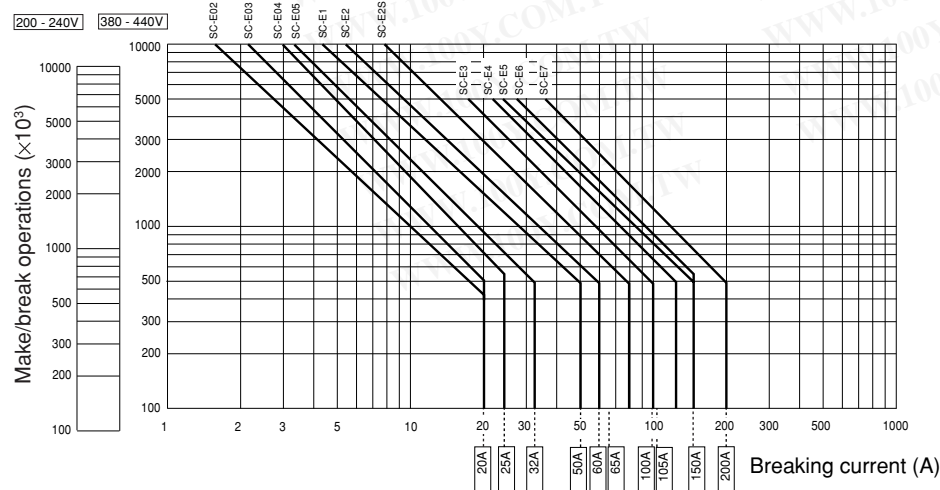

# DUO series Contactors

## SC-E series

### Optional accessories

#### ■ Optional accessories

##### • Auxiliary contact blocks with terminal covers

The front mounting auxiliary contact block allows two or four auxiliary contacts to be added without increasing the mounting area of the magnetic contactors. The side mounting auxiliary contact block allows two auxiliary contacts to be added to the magnetic contactors without increasing the depth.

Applicable contactor	Mounting	No. of contacts	Contact arrangement	Type
SC-E02 to E4	Front mounting	4	4NO 3NO+1NC 2NO+2NC	<b>SZ-A40/T</b> <b>SZ-A31/T</b> <b>SZ-A22/T</b>
		2	2NO 1NO+1NC 2NC	<b>SZ-A20/T</b> <b>SZ-A11/T</b> <b>SZ-A02/T</b>
SC-E02 to E4	Side mounting	2	1NO+1NC	<b>SZ-AS1/T</b>
SC-E5, E6, E7		2	1NO+1NC	<b>SZ-AS2/T</b>

##### • Main circuit surge suppression units

When contactor is energized or de-energized, a surge voltage is generated from motor circuit. This unit suppresses this surge voltage and protects electronic equipment from malfunction or damage.

Applicable contactor	Mounting	Rated voltage and frequency	CR constant	Applicable 3-phase motor	Type
SC-E02 to E05	Front mounting	250V AC	C=0.22 $\mu$ F	200–240V AC	<b>SZ-ZM1E</b>
	Side mounting	50/60Hz	R=100 $\Omega$	0.1–5.5kW	<b>SZ-ZM2E</b>
SC-E1 to E4	Front mounting	250V AC	C=0.33 $\mu$ F	200–240V AC	<b>SZ-ZM3E</b>
	Side mounting	50/60Hz	R=47 $\Omega$	0.1–22kW	<b>SZ-ZM4E</b>

##### • Coil surge suppression units

This unit suppresses surge voltage due to contactor ON-OFF operations, and can be easily connected to contactor coil terminals.

Applicable contactor		Operating coil voltage	Device	Operation indicator	Type
AC operated	DC operated				
SC-E02 to E05	SC-E02/G to E05/G	24–48V AC/DC	Varistor	–	<b>SZ-Z1</b>
	–	100–250V AC/DC		–	<b>SZ-Z2</b>
	–	380–440V AC		–	<b>SZ-Z3</b>
SC-E02 to E05	SC-E02/G to E05/G	24–48V AC/DC		Red LED	<b>SZ-Z6</b>
		100–250V AC/DC		Red LED	<b>SZ-Z7</b>
SC-E1 to E4	SC-E1/G to E4/G	24–48V AC/DC		–	<b>SZ-Z31</b>
		100–250V AC/DC		–	<b>SZ-Z32</b>
		380–440V AC		–	<b>SZ-Z33</b>
SC-E02 to E05	SC-E02/G to E05/G	24–48V AC/DC	CR	–	<b>SZ-Z4</b>
		100–250V AC/DC		–	<b>SZ-Z5</b>
SC-E02 to E05	SC-E02/G to E05/G	24–48V AC/DC		Red LED	<b>SZ-Z8</b>
		100–250V AC/DC		Red LED	<b>SZ-Z9</b>
SC-E1 to E4	–	24–48V AC		–	<b>SZ-Z34</b>
		100–250V AC		–	<b>SZ-Z35</b>
–	SC-E1/G to E4/G	24–48V DC		–	<b>SZ-Z36</b>
		100–250V DC		–	<b>SZ-Z37</b>

Front mounting



**SZ-A22/T**

KK02-081



**SZ-A11/T**

AF88-080

Side mounting



**SZ-AS1/T**  
**SZ-AS2/T**



KK01-090

Main circuit surge suppression units



Front mounting  
**SZ-ZM1E**

KK02-077



Side mounting  
**SZ-ZM4E**

KK02-079

Coil surge suppression unit



Top mounting  
CR  
**SZ-Z4**

AF88-766

• **Mechanical interlock unit**

The mechanical interlock unit provides a mechanical interlock with assembly parts to convert a magnetic contactor into a reversing magnetic contactor.

Applicable contactor	Type
SC-E02 to E4	<b>SZ-RM</b>
SC-E02/G to E4/G	

• **Power connection kit for reversing**

This kit includes an electrical interlock circuit to convert a magnetic contactor into a reversing magnetic contactor.

Applicable contactor	Wiring side	Type
SC-E02 to E05 SC-E02/G to E05/G	Line side	<b>SZ-ERW1/A</b>
	Load side	<b>SZ-ERW1/B</b>
	Load side (For starter)	<b>SZ-ERW1/D</b>
SC-E1 to E2S SC-E1/G to E2S/G	Line side	<b>SZ-ERW2/A</b>
	Load side	<b>SZ-ERW2/B</b>
	Load side (For starter)	<b>SZ-ERW2/D</b>
SC-E3, E4 SC-E3/G, E4/G	Line side	<b>SZ-ERW3/A</b>
	Load side	<b>SZ-ERW3/B</b>
	Load side (For starter)	<b>SZ-ERW3/D</b>
SC-E5	Line side	<b>SZ-ERW4/A</b>
	Load side	<b>SZ-ERW4/B</b>
SC-E6	Line side	<b>SZ-ERW5/A</b>
	Load side	<b>SZ-ERW5/B</b>
SC-E7	Line side	<b>SZ-ERW6/A</b>
	Load side	<b>SZ-ERW6/B</b>

Note : • When the SC-E02 to SC-E4 magnetic contactors and mechanical interlock unit are ordered separately, there is no electrical interlock circuit included. In this case, also order the SZ-A□/T auxiliary contact block to provide an electrical interlock.  
 • The SC-E5 to SC-E7 cannot be assembled as reversing motor starters. Use a separate mounting thermal overload relay (TK-E6H).



**Auxiliary contact blocks**

**Contact ratings**

• Based on IEC and JIS

Rated thermal current (A)	Making and breaking capacity at AC (A)		Rated operational current (A)			Minimum operating voltage and current	
			AC Voltage	DC Voltage	DC Voltage		
10	120V	60	120V	6	24V	3	5V DC 3mA
	220V	30	220V	3	48V	1.5	
	440V	15	440V	1.5	110V	0.55	
	600V	12	600V	1.2	220V	0.27	

• Based on UL and CSA

Rated thermal current (A)	Making and breaking current (A)					
	AC (rating code A600)			DC (rating code Q300)		
	Volts	Making	Breaking	Volts	Making	Breaking
10	120V	60	6	125V	0.55	0.55
	240V	30	3	250V	0.27	0.27
	480V	15	1.5			
	600V	12	1.2			

# DUO series Contactors

## SC-E series

### Dimensions

■ Dimensions, mm  
 • Non-reversing/AC operated  
 SC-E02, E03, E04, E05

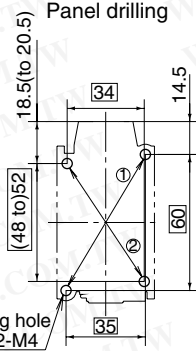
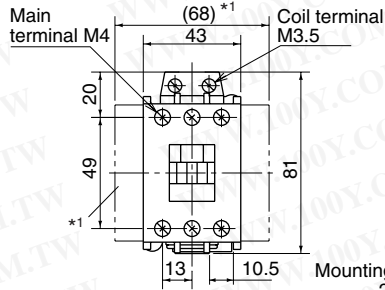
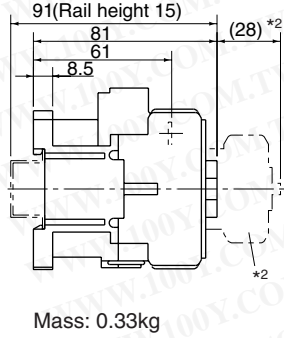

■ Wiring diagrams

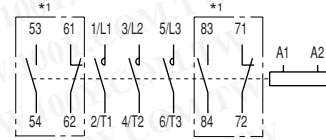

\*1 In case of aux. contact 2NO+2NC

Use the two mounting holes on a diagonal line  
 ① or ② to mount contactor  
 ①: 35 × 60 ②: 34 × (48 to 52)

SC-E1, E2, E2S

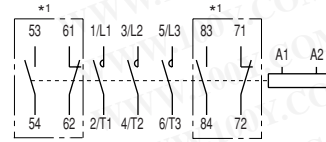
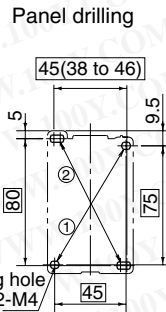
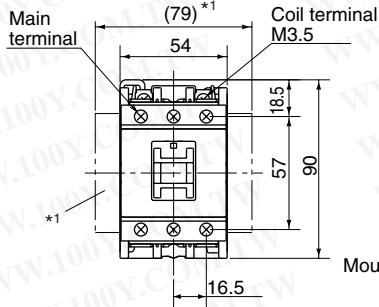
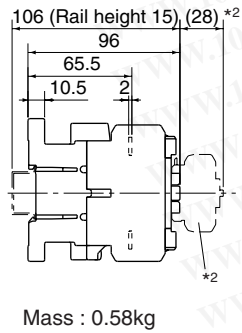

\*1 In case of aux. contact 2NO+2NC

Use the two mounting holes on a diagonal line  
 ① or ② to mount contactor  
 ①: 45 × 75 ②: 45 (38 to 46) × 80

SC-E3, E4

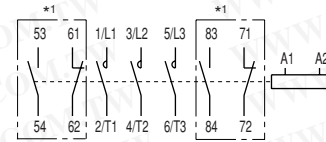
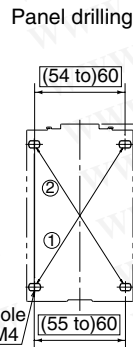
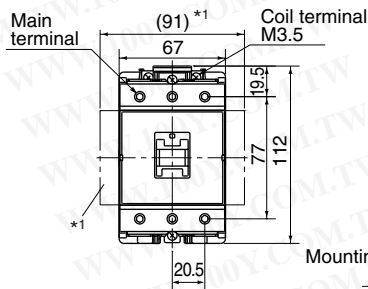
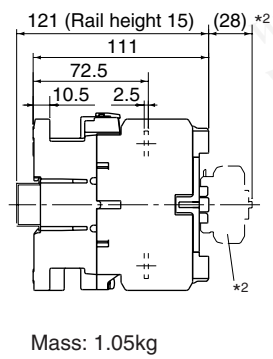

\*1 In case of aux. contact 2NO+2NC

Use the two mounting holes on a diagonal line  
 ① or ② to mount contactor  
 ①: (55 to) 60 × 90 ②: (54 to) 60 × 90

SC-E5

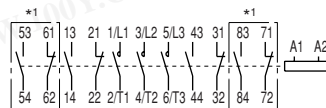
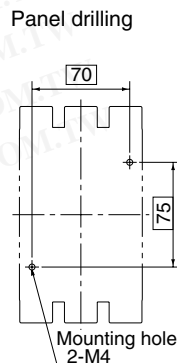
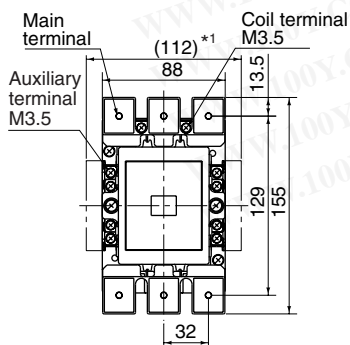
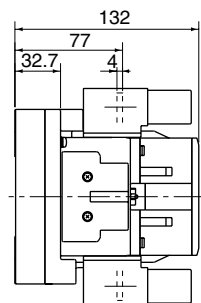

\*1 In case of aux. contact 4NO+4NC

Mass: 2.04kg

\*1 Side mounting aux. contact block  
 \*2 Front mounting aux. contact block

■ Dimensions, mm

• Non-reversing/AC operated

SC-E6

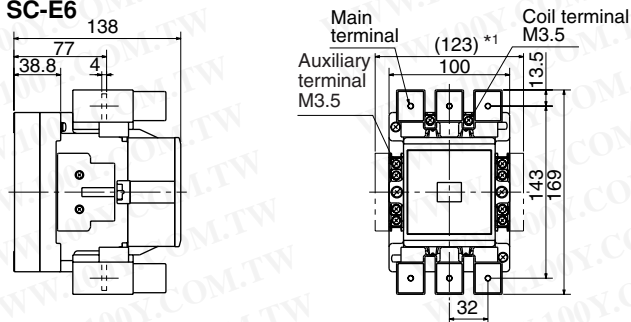

Mass: 2.55kg

SC-E7

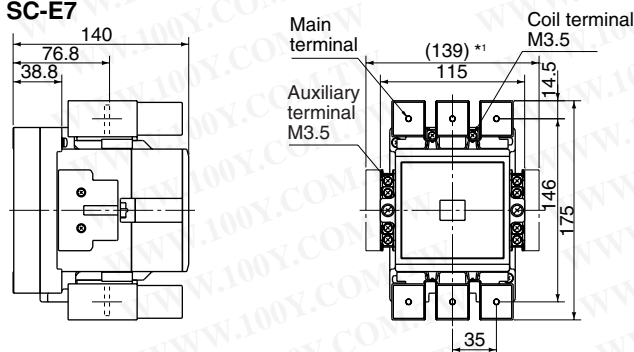

Mass: 2.86kg

• Non-reversing/DC operated

SC-E02/G, E03/G, E04/G, E05/G

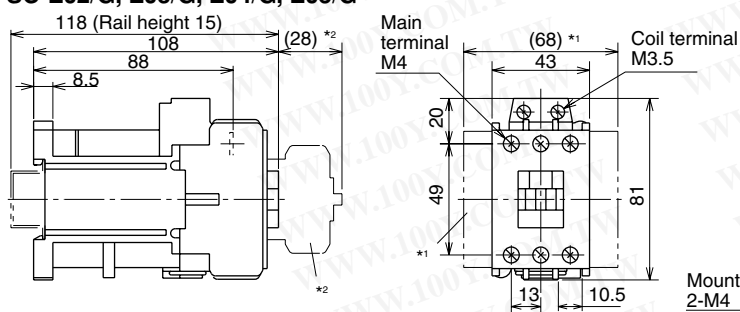

Mass: 0.59kg

SC-E1/G, E2/G, E2S/G

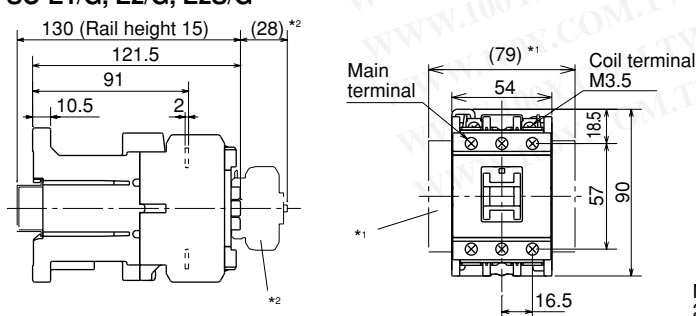

Mass: 0.79kg

\*1 Side mounting aux. contact block  
\*2 Front mounting aux. contact block

Use the two mounting holes on a diagonal line  
① or ② to mount contactor  
①: 45×75 ②: 45 (38 to 46)×80

# DUO series Contactors

## SC-E series

### Dimensions

#### ■ Dimensions, mm

#### • Non-reversing/DC operated SC-E3/G, E4/G

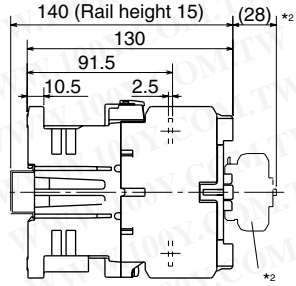

Mass: 1.4kg

\*1 Side mounting aux. contact block  
\*2 Front mounting aux. contact block

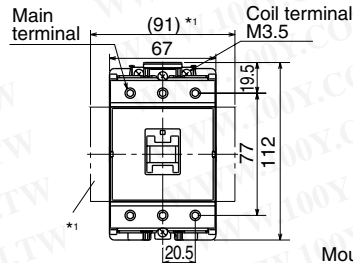

#### Panel drilling

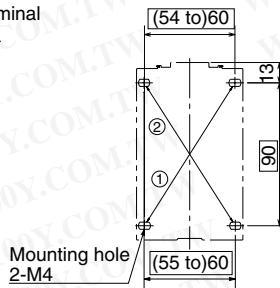

#### ■ Wiring diagrams

#### SC-E02RM to E4RM

(1NO+1NC) × 2

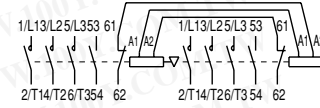

2NC × 2

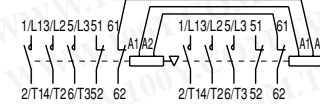

#### • Reversing/AC operated SC-E02RM, E03RM, E04RM, E05RM

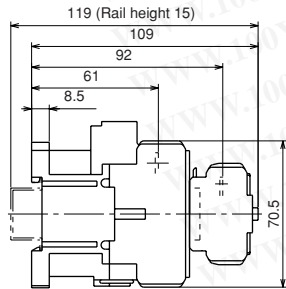

Mass : 0.8kg (AUX.4P)  
0.77kg(AUX.2P)

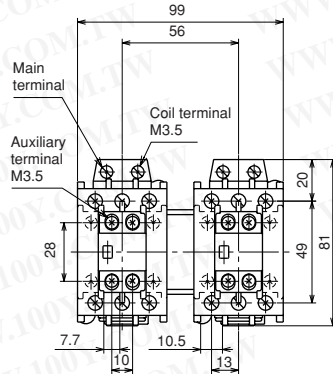

#### Panel drilling

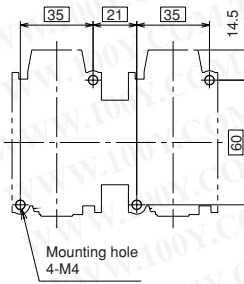

(2NO+2NC) × 2

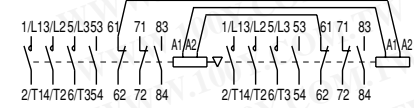

(3NO+NC) × 2

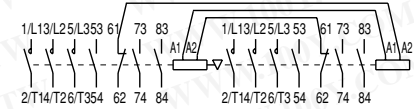

#### SC-E1RM, E2RM, E2SRM

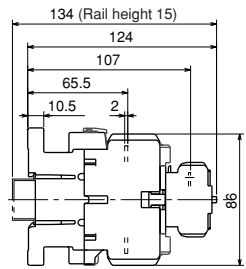

Mass : 1.3kg (AUX.4P)  
1.27kg(AUX.2P)

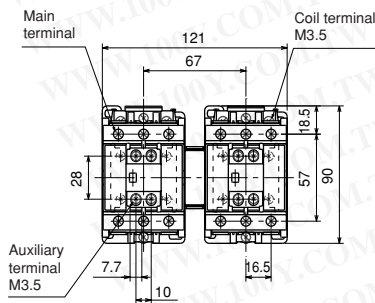

#### Panel drilling

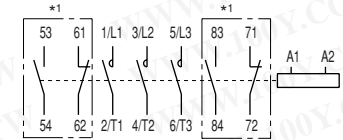
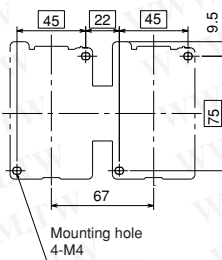

\*1 In case of aux. contact 2NO+2NC

Use the two mounting holes on a diagonal line  
① or ② to mount contactor  
①: (55 to) 60 × 90 ②: (54 to) 60 × 90

#### SC-E3RM, E4RM

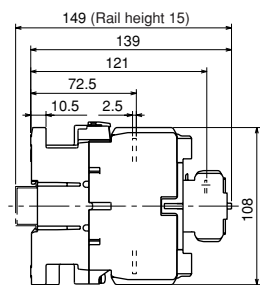

Mass : 2.24kg(AUX.4P)  
2.21kg(AUX.2P)

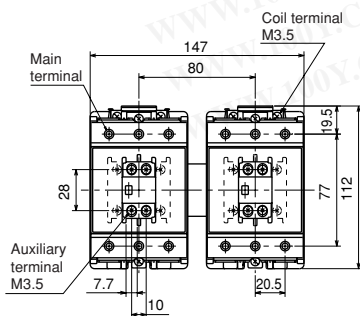

#### Panel drilling

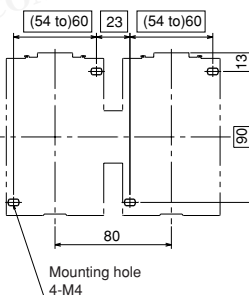

■ Dimensions, mm  
 • Reversing/AC operated  
**SC-E5RM**

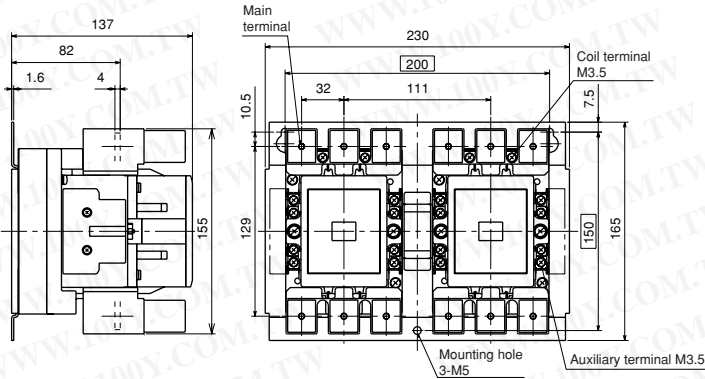

Mass : 4.64kg

**SC-E6RM**

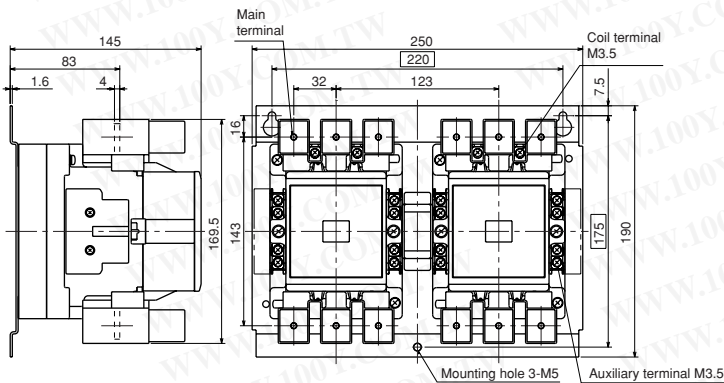

Mass : 5.8kg

**SC-E7RM**

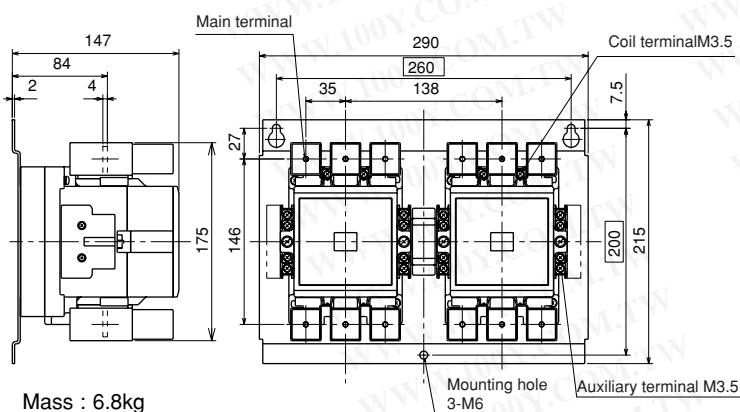

Mass : 6.8kg

■ Wiring diagrams  
**SC-E5RM to E7RM**

(1NO+1NC) × 2

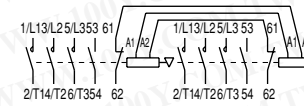

2NC × 2

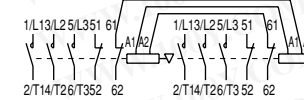

(2NO+2NC) × 2

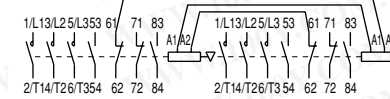

(3NO+NC) × 2

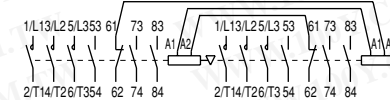

# DUO series Contactors

## SC-E series

### Dimensions

#### ■ Dimensions, mm

• Reversing/DC operated

SC-02RM/G, 03RM/G, 04RM/G, 05RM/G

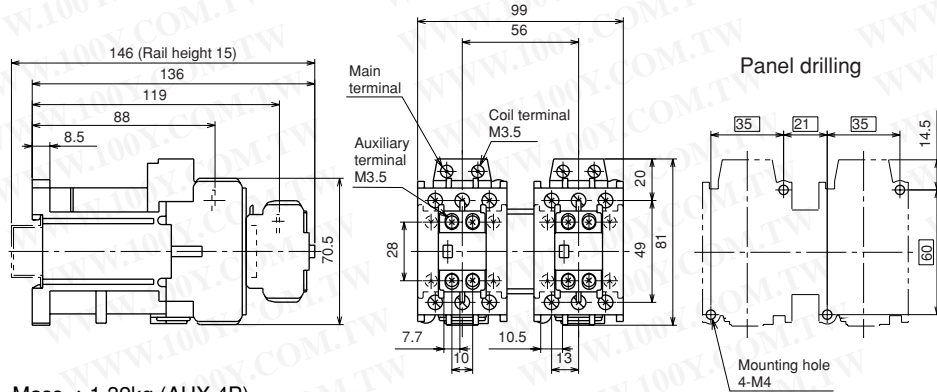

Mass : 1.32kg (AUX.4P)  
1.29kg(AUX.2P)

#### ■ Wiring diagrams

SC-E5RM to E7RM

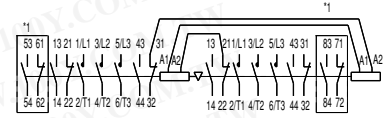

#### SC-E1RM/G, E2RM/G, E2SRM/G

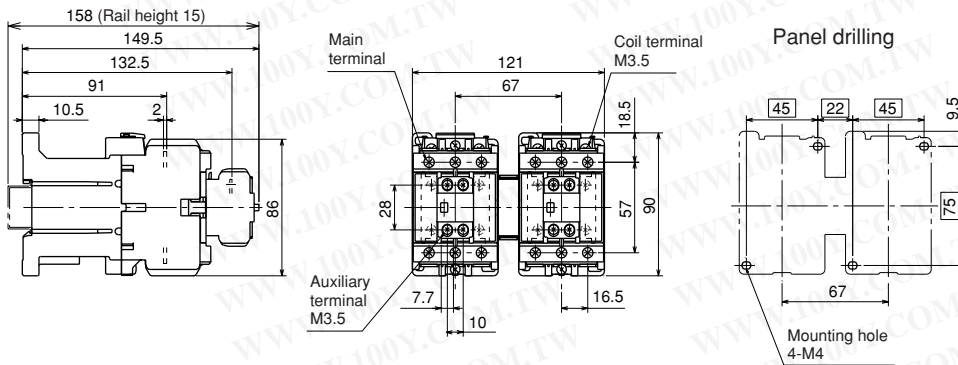

Mass : 1.72kg (AUX.4P)  
1.69kg(AUX.2P)

#### SC-E3RM/G, E4RM/G

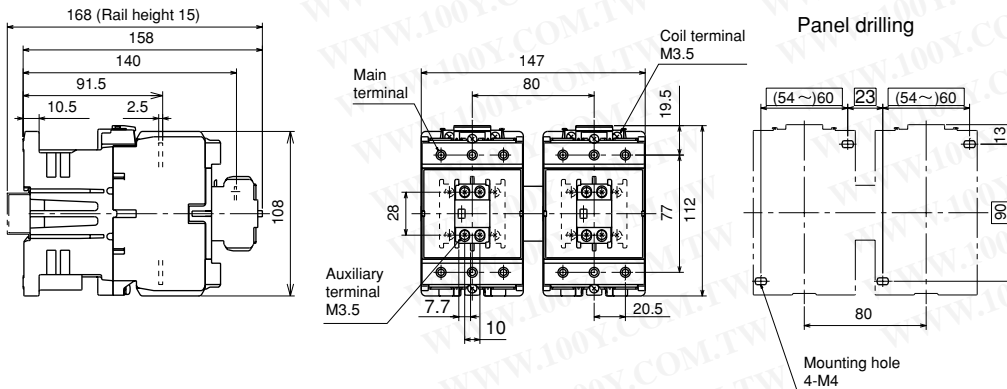

Mass : 2.84kg (AUX.4P)  
2.81kg(AUX.2P)

■ Dimensions, mm

• Auxiliary contact blocks/Front mounting

SZ-A40/T, A31/T, A22/T, A20/T, A11/T, A02/T for SC-E02 to E4

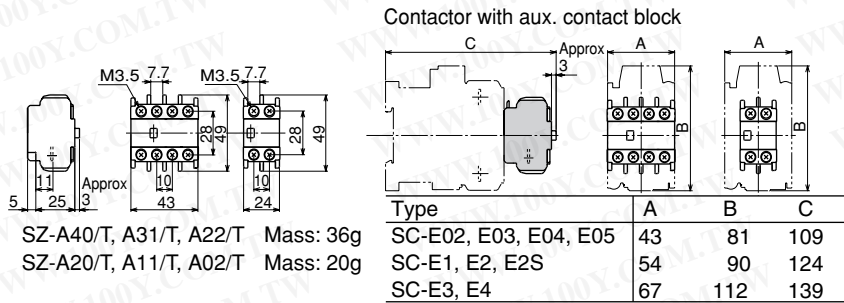

■ Wiring diagrams

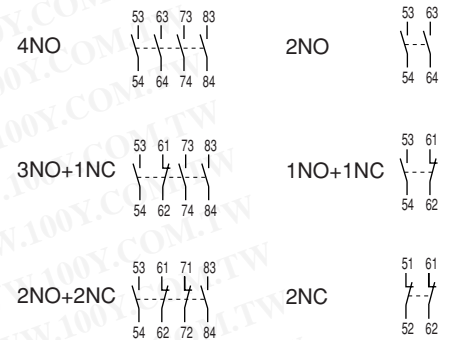

02

• Auxiliary contact blocks/Side mounting

SZ-AS1/T, for SC-E02 to E4

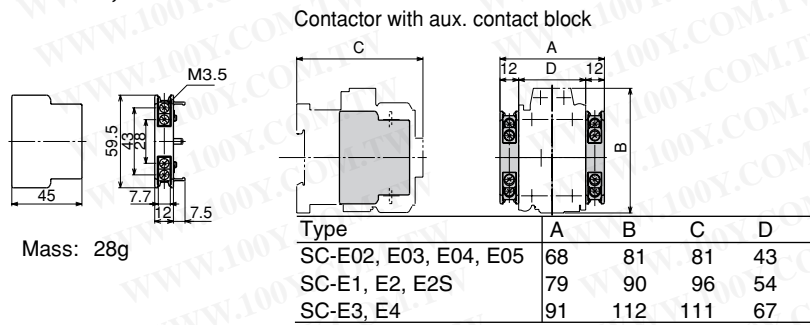

1NO+1NC

Mounted on right side



Mounted on left side



SZ-AS2/T, for SC-E5 to E7

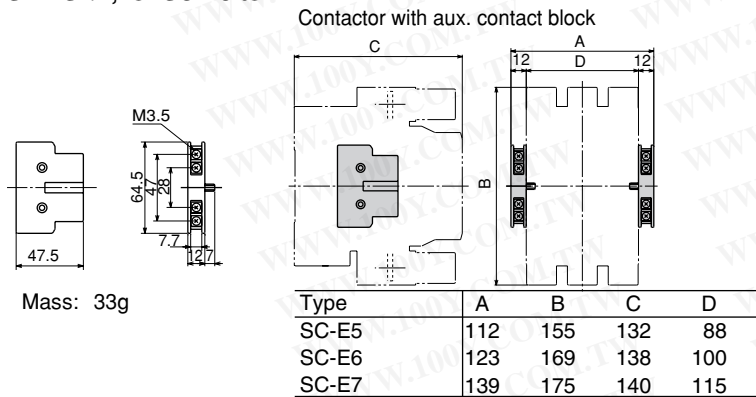

1NO+1NC

Mounted on right side



Mounted on left side



# DUO series Contactors

## SC-E series

### Dimensions

#### ■ Dimensions, mm

#### • Main circuit surge suppression units

##### SZ-ZM1E

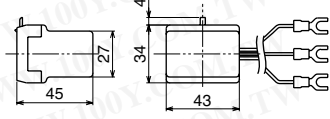

##### SZ-ZM3E

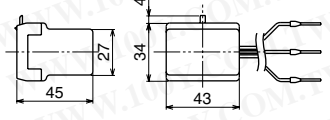

Mass: 60g

##### SZ-ZM2E

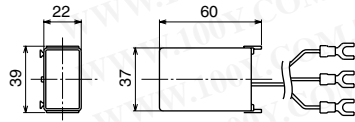

##### SZ-ZM4E

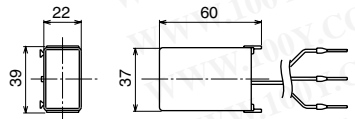

Mass: 60g

Contactor with surge suppression unit

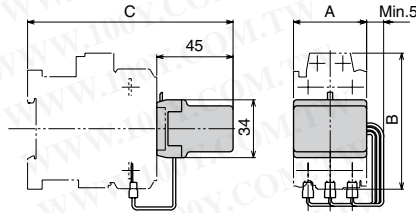

Type	A	B	C
SC-E02+SZ-ZM1E	43	81	121
SC-E03+SZ-ZM1E			
SC-E04+SZ-ZM1E			
SC-E05+SZ-ZM1E			
SC-E1+SZ-ZM3E	54	90	136
SC-E2+SZ-ZM3E			
SC-E2S+SZ-ZM3E			
SC-E3+SZ-ZM3E	67	112	151
SC-E4+SZ-ZM3E			

Contactor with surge suppression unit

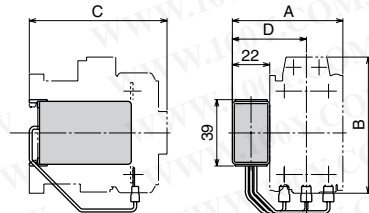

Type	A	B	C	D
SC-E02+SZ-ZM2E	65	81	81	43.5
SC-E03+SZ-ZM2E				
SC-E04+SZ-ZM2E				
SC-E05+SZ-ZM2E				
SC-E1+SZ-ZM2E				
SC-E2+SZ-ZM4E	76	90	96	49
SC-E2S+SZ-ZM4E				
SC-E3+SZ-ZM4E	89	112	111	55.5
SC-E4+SZ-ZM4E				

#### Connection diagram

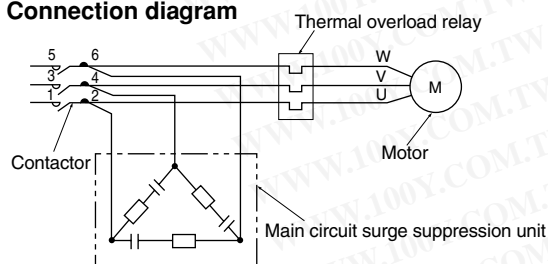

#### • Coil surge suppression units

##### SZ-Z1, Z2, Z3, Z4, Z5

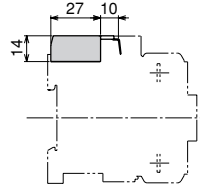

Mass: 14g

SC-E02 to E05 + SZ-Z1 to Z3  
(Built-in varistor)

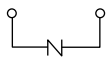

SC-E02 to E05 + SZ-Z4, Z5  
(Built-in CR)



##### SZ-Z6, Z7, Z8, Z9

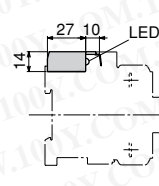

Mass: 16g

SC-E02 to E05 + SZ-Z6, Z7  
(Built-in varistor with operating indicator)

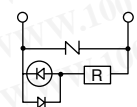

SC-E02 to E05 + SZ-Z8, Z9  
(Built-in CR with operating indicator)

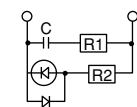

##### SZ-Z31, Z32, Z33, Z34, Z35, Z36, Z37

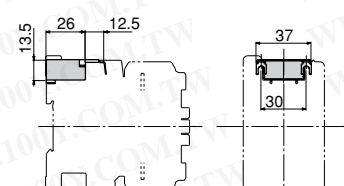

Mass: 15g

SC-E1 to E4 + SZ-Z31 to Z33  
(Built-in varistor)

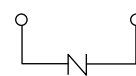

SC-E1 to E4 + SZ-Z34, Z35  
(Built-in CR)  
SC-E1/G to E4/G + SZ-Z36, Z37  
(Built-in CR)

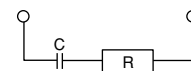

■ Dimensions, mm  
• Mechanical interlock unit  
SZ-RM

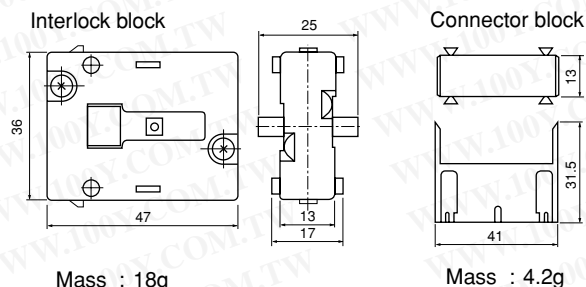

• Power connection kit for reversing  
For crossover wiring/SZ-ERW1/A

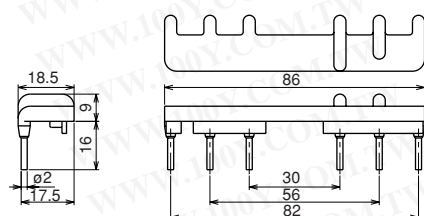

Mass : 19g

Used with	Wiring side	Wiring
SC-E02RM, E03RM, E04RM, E05RM SC-E02RM/G, E03RM/G, E04RM/G, E05RM/G	Line side	

Note : When using this connection kit, use a separate mounting thermal overload relay to connect to the magnetic contactor. If the attachment tab is used for assembly to the magnetic contactor, interference by components will make assembly impossible. To assemble using the attachment tab, use the SZ-ERW1/D type power connection kit.

For phase replacing wiring/SZ-ERW1/B

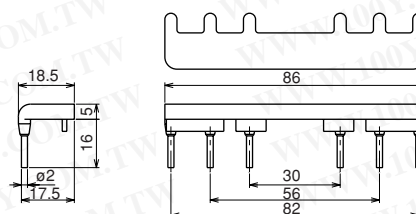

Mass : 17g

Used with	Wiring side	Wiring
SC-E02RM, E03RM, E04RM, E05RM SC-E02RM/G, E03RM/G, E04RM/G, E05RM/G	Load side	

Note : When using this connection kit, use a separate mounting thermal overload relay to connect to the magnetic contactor. If the attachment tab is used for assembly to the magnetic contactor, interference by components will make assembly impossible. To assemble using the attachment tab, use the SZ-ERW1/D type power connection kit.

For phase replacing wiring/SZ-ERW1/D

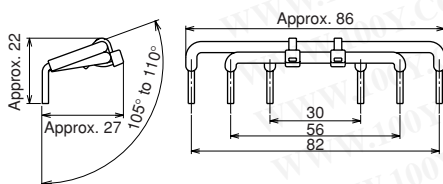

Mass : 13g

Used with	Wiring side	Wiring	Cable
SC-E02RM, E03RM, E04RM, E05RM SC-E02RM/G, E03RM/G, E04RM/G, E05RM/G	Load side		UL No3271 AWG12(Dia. Ø2) Color : Black

Note : Use this connection kit for assembly using the attachment tab of the thermal overload relay.

For crossover wiring/SZ-ERW2/A

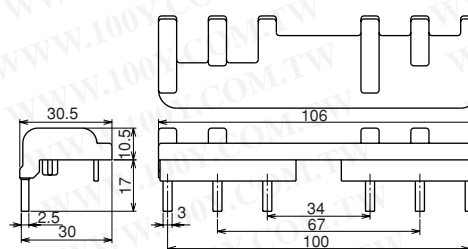

Mass : 48g

Used with	Wiring side	Wiring
SC-E1RM, E2RM, E2SRM SC-E1RM/G, E2RM/G, E2SRM/G	Line side	

Note : When using this connection kit, use a separate mounting thermal overload relay to connect to the magnetic contactor. If the attachment tab is used for assembly to the magnetic contactor, interference by components will make assembly impossible. To assemble using the attachment tab, use the SZ-ERW2/D type power connection kit.

# DUO series Contactors

## SC-E series

### Dimensions

#### ■ Dimensions, mm

##### For phase replacing wiring/SZ-ERW2/B

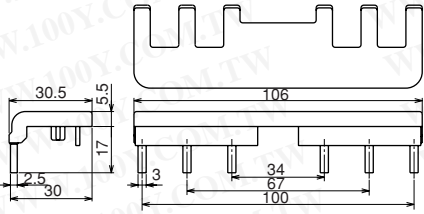

Mass : 42g

Used with	Wiring side	Wiring
SC-E1RM, E2RM, E2SRM	Load side	
SC-E1RM/G, E2RM/G, E2SRM/G		

Note : When using this connection kit, use a separate mounting thermal overload relay to connect to the magnetic contactor. If the attachment tab is used for assembly to the magnetic contactor, interference by components will make assembly impossible. To assemble using the attachment tab, use the SZ-ERW2/D type power connection kit.

##### For crossover wiring/SZ-ERW3/A

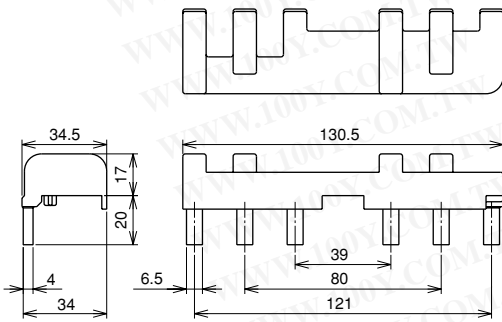

Mass : 162g

Used with	Wiring side	Wiring
SC-E3RM, E4RM	Line side	
SC-E3RM/G, E4RM/G		

Note : When using this connection kit, use a separate mounting thermal overload relay to connect to the magnetic contactor. If the attachment tab is used for assembly to the magnetic contactor, interference by components will make assembly impossible. To assemble using the attachment tab, use the SZ-ERW3/D type power connection kit.

##### For phase replacing wiring/SZ-ERW3/B

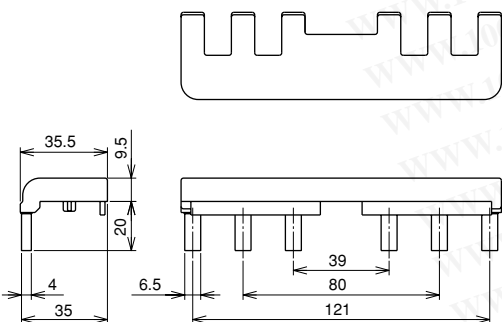

Mass : 138g

Used with	Wiring side	Wiring
SC-E3RM, E4RM	Load side	
SC-E3RM/G, E4RM/G		

Note : When using this connection kit, use a separate mounting thermal overload relay to connect to the magnetic contactor. If the attachment tab is used for assembly to the magnetic contactor, interference by components will make assembly impossible. To assemble using the attachment tab, use the SZ-ERW3/D type power connection kit.

##### For phase replacing wiring/SZ-ERW2/D

Terminal No. : 6/T3 – 2/T1

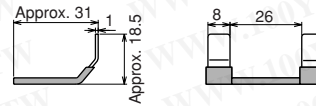

Terminal No. : 4/T2 – 4/T2

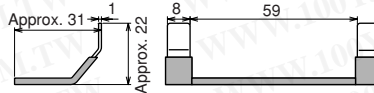

Terminal No. : 2/T1 – 6/T3

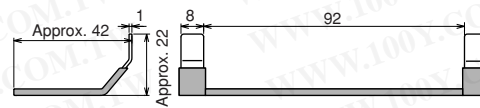

Mass : 31g

Used with	Wiring side	Wiring
SC-E1RM, E2RM, E2SRM	Load side	
SC-E1RM/G, E2RM/G, E2SRM/G		

Note : Use this connection kit for assembly using the attachment tab of the thermal overload relay.

##### For phase replacing wiring/SZ-ERW3/D

Terminal No. : 6/T3 – 2/T1

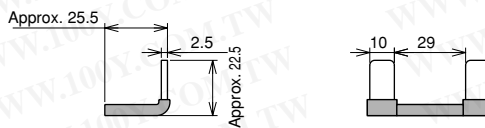

Terminal No. : 4/T2 – 4/T2

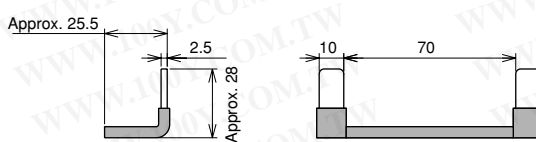

Terminal No. : 2/T1 – 6/T3

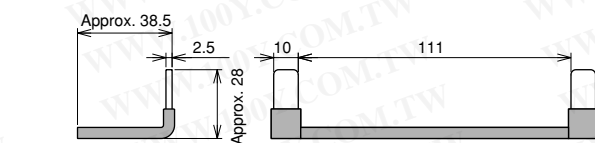

Mass : 110g

Used with	Wiring side	Wiring
SC-E3RM, E4RM	Load side	
SC-E3RM/G, E4RM/G		

Note : Use this connection kit for assembly using the attachment tab of the thermal overload relay.

■ Dimensions, mm

For crossover wiring/SZ-ERW4/A  
 For phase replacing wiring/SZ-ERW4/B

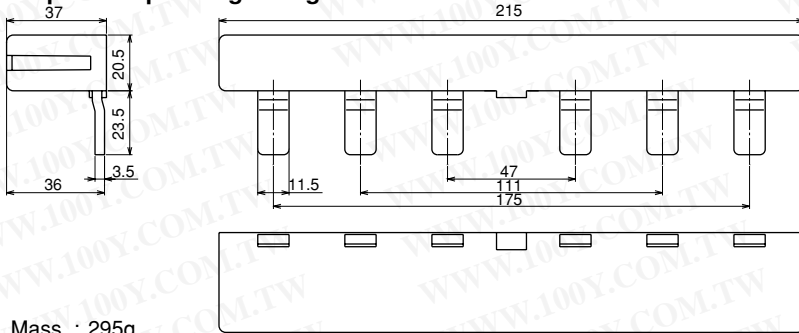

Mass : 295g

Used with	Type	Wiring side	Wiring
SC-E5RM	SZ-ERW4/A	Line side	
	SZ-ERW4/B	Load side	

Note : When using this connection kit, use a separate mounting thermal overload relay to connect to the magnetic contactor.

For crossover wiring/SZ-ERW5/A  
 For phase replacing wiring/SZ-ERW5/B

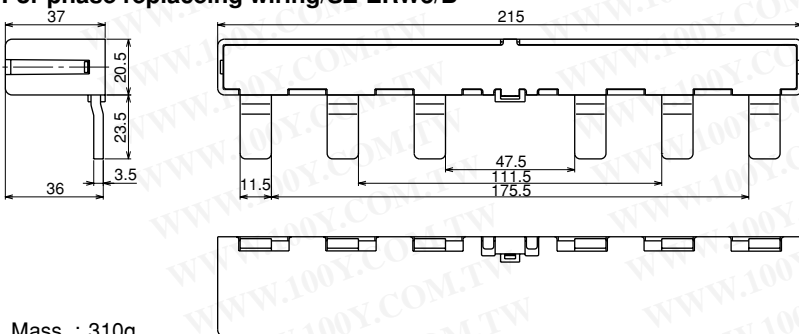

Mass : 310g

Used with	Type	Wiring side	Wiring
SC-E6RM	SZ-ERW5/A	Line side	
	SZ-ERW5/B	Load side	

Note : When using this connection kit, use a separate mounting thermal overload relay to connect to the magnetic contactor.

For crossover wiring/SZ-ERW6/A  
 For phase replacing wiring/SZ-ERW6/B

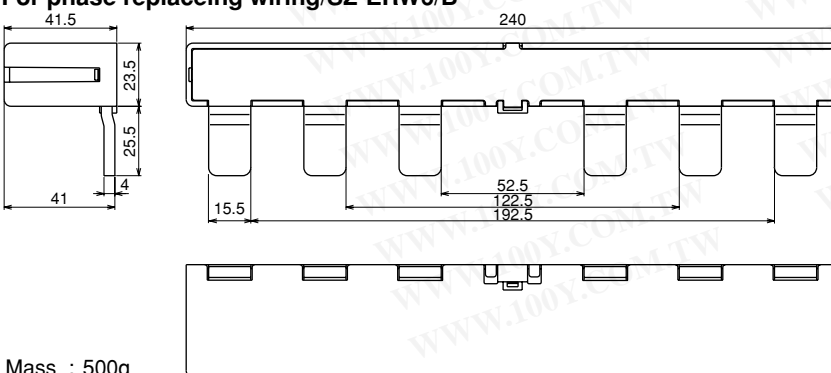

Mass : 500g

Used with	Type	Wiring side	Wiring
SC-E7RM	SZ-ERW6/A	Line side	
	SZ-ERW6/B	Load side	

Note : When using this connection kit, use a separate mounting thermal overload relay to connect to the magnetic contactor.

# DUO series Contactors

## SC-E series

### Operation conditions

#### ■ Standard operating conditions

The magnetic contactors are manufactured for use in the standard operating conditions given in the table at the right. Consult FUJI before using the magnetic contactors in different conditions.

#### ■ Wirings

##### • Connection wires and terminal processing

Be sure to perform wiring correctly with reference to the connections diagram. Main terminals for models SC-E02 to SC-E7 are wired using solid wires or stranded wires. Stranded wires or flexible stranded wires can be connected by twisting them together, crimping a sleeve (ferrule) onto them before connecting.



##### • Tightening torque

If wires are not tightened sufficiently, they may become hot or come loose and result in a fire, short-circuit, electric shock, or some other potentially dangerous situation. Be sure to tighten the wires to the torques specified in the tables below.

##### • Connectable wire sizes, tightening tools, tightening torques

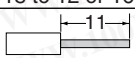
###### Main circuit

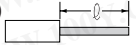
Contactor type	SC-E02, SC-E03, SC-E04, SC-E05	
Solid wire (mm <sup>2</sup> )	One	0.75 to 6
	Two	1 to 4 or 1.5 to 6
Stranded wire (mm <sup>2</sup> ) *1	One	0.75 to 6
	Two	1 to 4 or 1.5 to 6
AWG	One	18 to 10
	Two	18 to 12 or 16 to 10
Sheath stripping length (mm)		
Terminal screw size	M4	
Tool	⊕ Phillips screwdriver, H-type, No. 2 (ISO 8764) ⊖ Flat-blade screwdriver, 1×5.5×L-type, B (ISO 2830)	
Tightening torque (N·m)	1.2 to 1.5	

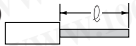
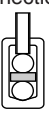
Contactor type	SC-E1, E2, E2S			SC-E3, E4	SC-E5, E6	SC-E7
Top-only connection 	Solid or stranded wire (mm <sup>2</sup> ) *1		0.75 to 35	1 to 70	2.5 to 70	4 to 120
	Flexible stranded wire with sleeve (mm <sup>2</sup> )		0.75 to 25	1 to 50	2.5 to 50	2.5 to 95
	Flexible stranded wire without sleeve (mm <sup>2</sup> )		0.75 to 25	1 to 50	2.5 to 50	4 to 95
	AWG		18 to 2	16 to 2/0	12 to 2/0	12 to 250MCM
Sheath stripping length (mm)			15	19.5	26.5	28.5
Bottom-only connection 	Solid or stranded wire (mm <sup>2</sup> ) *1		0.75 to 25	1 to 50	2.5 to 70	4 to 120
	Flexible stranded wire with sleeve (mm <sup>2</sup> )		0.75 to 16	1 to 35	2.5 to 50	2.5 to 95
	Flexible stranded wire without sleeve (mm <sup>2</sup> )		0.75 to 16	1 to 35	2.5 to 50	4 to 95
	AWG		18 to 3	16 to 1/0	12 to 2/0	12 to 250MCM
Sheath stripping length (mm)			12.5	16	26.5	28.5
Top/bottom connection 	Solid or stranded wire (mm <sup>2</sup> ) *1	Top/bottom	0.75 to 25	1 to 50	2.5 to 70	4 to 120
	Flexible stranded wire with sleeve (mm <sup>2</sup> )	Top/bottom	0.75 to 16	1 to 35	2.5 to 50	2.5 to 95
	Flexible stranded wire without sleeve (mm <sup>2</sup> )	Top/bottom	0.75 to 16	1 to 35	2.5 to 50	4 to 95
	AWG	Top/bottom	18 to 3	16 to 1/0	12 to 2/0	12 to 250MCM
Tool	⊕ Phillips screwdriver, H-type, No. 2 (ISO 8764) ⊖ Flat-blade screwdriver, 1×5.5×L-type, B (ISO 2830)			⊙ Hex. wrench 4 (ISO 2936)		
Tightening torque (N·m)	2.5			8		10
Self-locking torque (N·m) *2	1			2		

Notes: \*1 Stranded wire (0 to 35mm<sup>2</sup>) consists of 7 wires or less.  
Stranded wire (38 to 120mm<sup>2</sup>) consists of 19 wires or less.  
Flexible stranded wire consists of more number wires than the above.

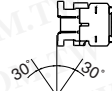
Ambient temperature	Operating: -5 to 55°C No sudden temperature changes resulting in condensation or icing (The average temperature over a 24-hour period must not exceed 35°C) Storage: -40 to 65°C
Humidity	45 to 85%RH
Altitude	2000m or lower
Atmosphere	No excessive dust, smoke, corrosive gases, flammable gases, steam, or salt
Vibration	10 to 55Hz 15m/s <sup>2</sup>
Shock	50m/s <sup>2</sup>
Mounting	Screw mounting, 35mm IEC top hat rail mounting (SC-E02 to SC-E4)
Mounting angle	 
Standard	IEC 60947-4-1, EN 60947-4-1, VDE 0660 JIS C 8201-4-1, UL 508, CSA C22.2 TÜV (EN60947-4-1)

###### Control circuit







Solid or stranded wire (mm <sup>2</sup> )	One	0.75 to 2.5 (ø1 to 1.6)
	Two	0.75 to 1.5 or 1.5 to 2.5
AWG	One	18 to 14
	Two	18 to 14
Sheath stripping length (mm)		
Fork terminal	Max. 7.7mm wide	
Terminal screw size	M3.5	
Tool	⊕ Phillips screwdriver, H-type, No. 2 (ISO 8764) ⊖ Flat-blade screwdriver, 1×5.5×L-type, B (ISO 2830)	
Tightening torque (N·m)	0.8 to 1	

Tightening torque (N·m) 0.8 to 1



勝特力材料 886-3-5753170  
 勝特力电子(上海) 86-21-34970699  
 勝特力电子(深圳) 86-755-83298787  
[Http://www.100y.com.tw](http://www.100y.com.tw)



• **Connectable wire size and tightening torque (Ring terminal connection type)**

**Main circuit**

Contacteur type	Terminal screw *1	Connectable wire size (mm <sup>2</sup> )	Applicable ring terminal max. width (mm) *2 *4	Tightening torque (N·m)
SC-E02P to E05P	M4  	1.25 to 6	9.7 (R1.25-4 to R5.5-4)	1.2 to 1.5
SC-E1P to E2SP	M5  	2 to 22	12.4 *3 (R2-5 to R22-5)	2.0 to 2.5
SC-E3P, E4P	M6  	2 to 38	16.7 *3 (R2-6 to R38-6)	4.0 to 5.0



**Control circuit**

Contacteur type	Terminal screw *1	Connectable wire size (mm <sup>2</sup> )	Applicable ring terminal max. width (mm) *2	Tightening torque (N·m)
	Coil terminal (Contacteur)	Coil terminal (Contacteur)	Coil terminal (Contacteur)	Coil terminal (Contacteur)
SC-E02P to E4P	M3.5  	1.25 to 2 (1.2 to 2mm dia.)	7.7 (R1.25-3.5 to R2-3.5)	0.8 to 1.0

Note 1 The motor starter has plus-minus shaped terminal screws of   (M4, M5).

Note 2 Two wires or two crimp terminals can be connected to each terminal.

Note 3 Use insulation caps to use ring crimp terminals.

\*1  : Cross-recessed pan-head screw  : Non-oriented square washer, turtleback washer

- : Circular bright plain washer  : Cross-recessed hexagonal head bolt

\*2 Round crimp terminal JIS C 2805

\*3 Use crimp terminals of max. width or less. (Use narrow-width terminals made by crimp terminal manufacturers.)

\*4 Use crimp terminal manufacturers' standard models.