

勝特力材料 886-3-5753170
 勝特力电子(上海) 86-21-34970699
 勝特力电子(深圳) 86-755-83298787
 Http://www.100y.com.tw

Other Protistor® Fuses BS88-4 Fuses

10x51, 17x49, 2X17x49, - 690 VAC



EXTREMELY HIGH BREAKING CAPACITY FUSES:
 PROTECTION OF POWER SEMICONDUCTORS AS PER
 IEC STANDARD 60269.1 AND 4

690 V VOLTAGE RATING COMPLYING WITH IEC 33
 GR CLASS (RATINGS FROM 5 TO 160 A)
 AS PER VDE 636-23 AND IEC 60269.4

TWO MODELS COMPLYING WITH BS 88-4
 - WITHOUT INDICATOR
 - WITH SEPARATE TRIP-INDICATOR
 (SIZES 17x49 AND 2x17x49)

17x49 URS fuses are UL Recognized 

Main Characteristics

Voltage rating U_N (V)	Size	Class	Current rating I_N (A)	Pre-arcing $I^2t @ 1 \text{ ms}$ I^2t_p (A ² s)	Total clearing $I^2t @ 660 \text{ V}$ A ² s		Watts loss		Tested Breaking capacity
					$I_p \leq 30I_N$	$I_p > 30I_N$	$0.8 I_N$	I_N	
690V	10 x51	URE	5	1.3	10	15	1.05	2	200k A @ 690 V
			6	1.3	13.5	20.5	1.3	2.5	
			10	3.3	25	35	2.2	4.1	
			12	5.5	40	58	2.3	4.3	
			15	9.7	70	100	2.4	4.4	
			20	19.4	120	200	3.1	5.8	
	17x49	URS	16	9.7	75	107	2.7	4.8	200k A @ 690 V
			20	17.3	130	185	2.9	5.3	
			25	27	200	285	3.7	6.7	
			32	53	400	570	4.7	8.6	
			35	70	510	725	5.2	9.6	
			40	98	760	1080	5.7	10.5	
			45	130	900	1280	6.2	11.4	
			50	156	1000	1420	6.8	12.6	
			55	210	1380	1970	7.2	13.3	
			63	315	2000	2850	7.5	13.9	
			75	525	3350	4630	7.8	14.4	
			80	625	3900	5700	8.5	15.8	
	2x17x49	URT	65	210	1590	2270	9.5	17.4	200k A @ 690 V
			75	310	2300	3280	10.9	20	
			85	430	3050	4350	11.9	21.9	
			90	252	3600	5130	12.4	22.8	
			110	850	5500	7840	13.8	26.5	
			145	1730	11000	15700	15.5	28.5	
150			2090	13400	18500	15.6	28.7		
160			2500	15600	22800	16.9	31.5		

Minimum operating voltage for separate trip indicator = 20 V

Semiconductor (AC) fuses



Other Protistor® Fuses

BS88-4 Fuses

10x51, 17x49, 2X17x49, - 690 VAC

CP 10x51 Without trip-indicator

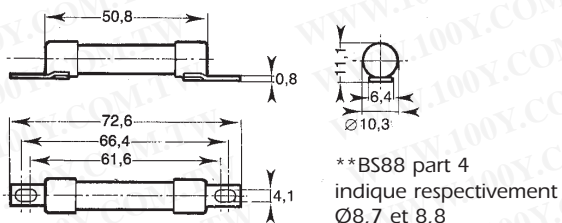

Size	Designation	Ref. Number	Pack.	Catalog Number
10x51	6,9 URE 10/5	D082458	10 (13g)	BS10UE69V5
	6,9 URE 10/6	X097057		BS10UE69V6
	6,9 URE 10/10	C082457		BS10UE69V10
	6,9 URE 10/12	Z097059		BS10UE69V12
	6,9 URE 10/15	B082456		BS10UE69V15
	6,9 URE 10/20	A082455		BS10UE69V20

CP 17x49 Without trip-indicator

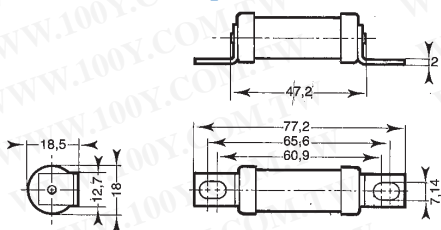

Size	Designation	Ref. Number	Pack.	Catalog Number
17x49	6,9 URS 17/16	G075883	10 (51g)	BS17US69V16
	6,9 URS 17/20	H075884		BS17US69V20
	6,9 URS 17/25	J075885		BS17US69V25
	6,9 URS 17/32	K075886		BS17US69V32
	6,9 URS 17/35	L075887		BS17US69V35
	6,9 URS 17/40	M075888		BS17US69V40
	6,9 URS 17/45	N075889		BS17US69V45
	6,9 URS 17/50	P075890		BS17US69V50
	6,9 URS 17/55	Q075891		BS17US69V55
	6,9 URS 17/63	R075892		BS17US69V63
	6,9 URS 17/75	S075893		BS17US69V75
	6,9 URS 17/80	T075894		BS17US69V80

CP 17x49 With separated trip-indicator BS88

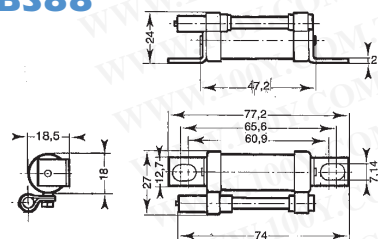

Size	Designation	Ref. Number	Pack.	Catalog Number
17x49	6,6 URS 17P16	V075895	10 (61g)	BS17US69V16P
	6,9 URS 17P20	W075896		BS17US69V20P
	6,9 URS 17P25	X075897		BS17US69V25P
	6,9 URS 17P32	Y075898		BS17US69V32P
	6,9 URS 17P35	Z075899		BS17US69V35P
	6,9 URS 17P40	A075900		BS17US69V40P
	6,9 URS 17P45	B075901		BS17US69V45P
	6,9 URS 17P50	K081084		BS17US69V50P
	6,9 URS 17P55	C075902		BS17US69V55P
	6,9 URS 17P63	D075903		BS17US69V63P
	6,9 URS 17P75	E075904		BS17US69V75P
	6,9 URS 17P80	F075905		BS17US69V80P

CP 2x17x49 Without trip-indicator

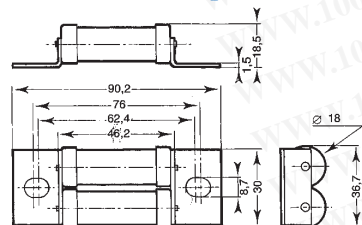

Size	Designation	Ref. Number	Pack.	Catalog Number
2x17x49	6,6 URT 217/65	G075906	5 (82g)	BS217UT69V65
	6,9 URT 217/75	F099572		BS217UT69V75
	6,9 URT 217/85	H075907		BS217UT69V85
	6,9 URT 217/90	A099958		BS217UT69V90
	6,9 URT 217/110	B099959		BS217UT69V110
	6,9 URT 217/140	J075908		BS217UT69V140
	6,9 URT 217/150	C099960		BS217UT69V150
	6,9 URT 217/160	K075909		BS217UT69V160

CP 2x17x49 With separated trip-indicator

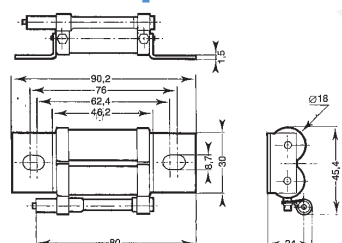

Size	Designation	Ref. Number	Pack.	Catalog Number
2x17x49	6,6 URT 217P65	L075910	5 (95g)	BS217UT69V65P
	6,9 URT 217P75	M075911		BS217UT69V75P
	6,9 URT 217P85	N075912		BS217UT69V85P
	6,9 URT 217P90	P075913		BS217UT69V90P
	6,9 URT 217P110	Q075914		BS217UT69V110P
	6,9 URT 217P140	R075915		BS217UT69V140P
	6,9 URT 217P150	S075916		BS217UT69V150P
	6,9 URT 217P160	T075917		BS217UT69V160P



Semiconductor (AC) fuses

Other Protistor® Fuses BS88-4 Fuses

10x51, 17x49, 2X17x49, - 690 VAC

Times vs current characteristics

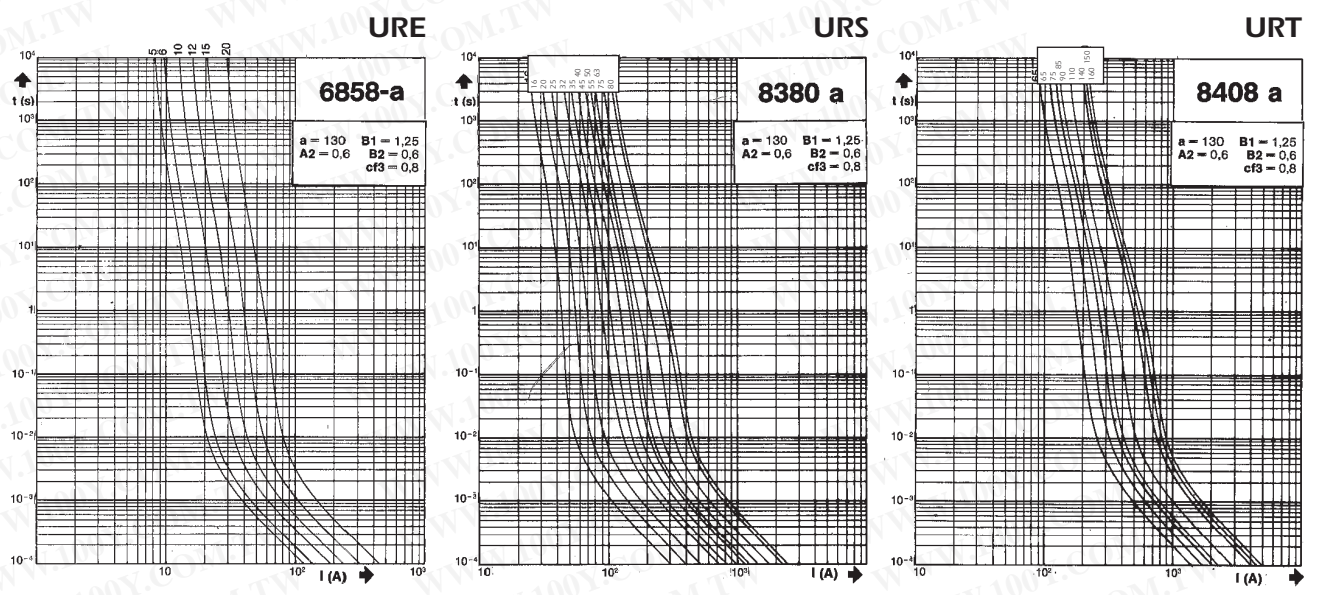

- These curves indicate, for each rated current, the pre-arcing time vs. the R/M.S. pre-arcing current.
- Tolerance for the mean pre-arcing current $\pm 10\%$

Corrective factor - Peak arc voltage

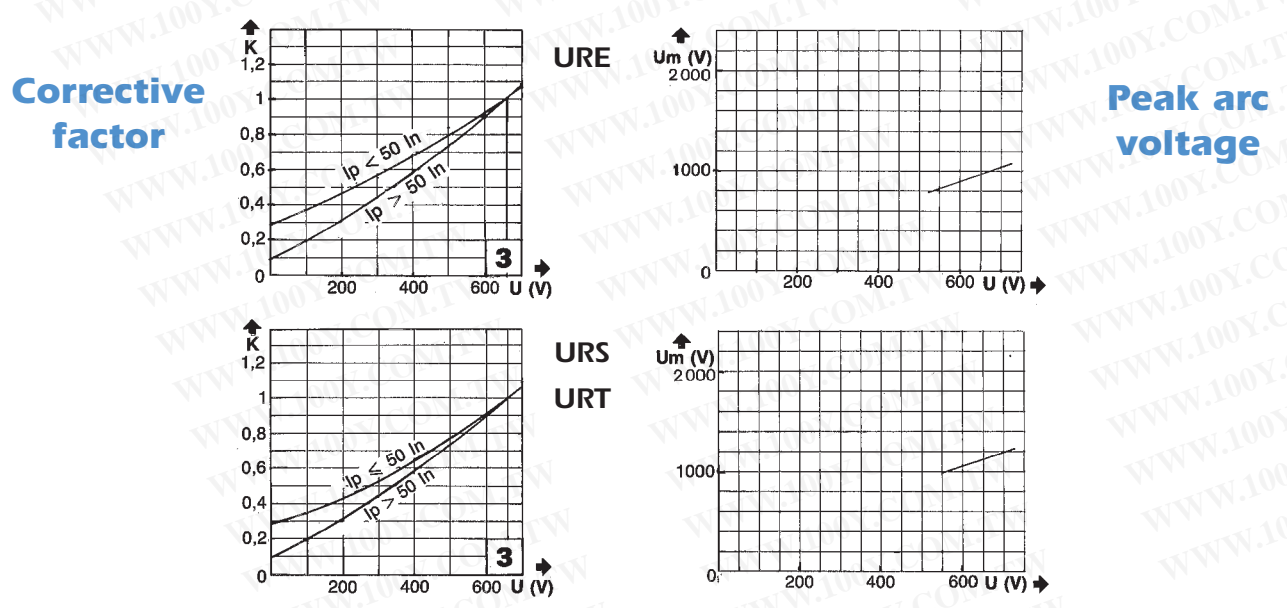

Corrective factor

* The mean curves show the variation of the total clearing time ($I^2 t_f$) and the total clearing duration t_f as a function of operating voltage U

Peak arc voltage

This curve show the peak value U_m of the arc voltage which appears across the fuse link as a function of the operating voltage U @ $\cos \varphi = 0.15$.

Semiconductor (AC) fuses



Other Protistor® Fuses

BS88-4 Fuses

10x51, 17x49, 2X17x49, - 690 VAC

D.C Applications data

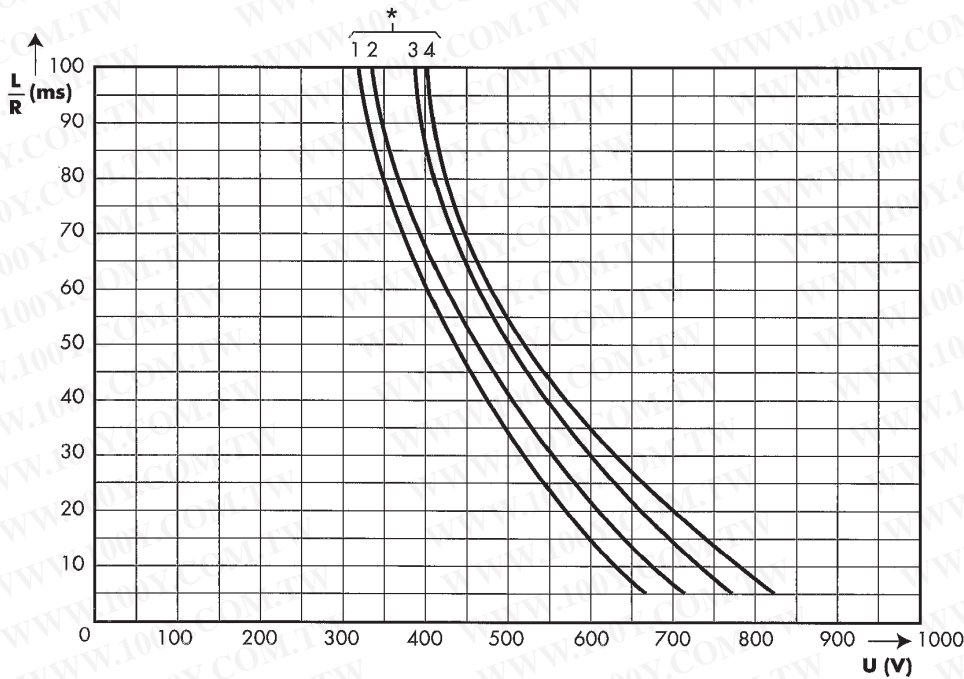

▪ These curve indicate the permissible value of time constant L/R as a function of the D.C. working voltage.

▪ These I_{pm} values give the minimum DC interrupting current in amps.

Curves and I _{pm} for each rating			
Class	Rated current	*	I _{pm} (A)
URE	5	4	40
	6	4	48
	10	4	60
	12	4	84
	15	4	112
	20	4	140
URS	16	3	96
	20	3	140
	25	3	175
	32	3	255
	35	3	300
	40	3	320
	45	3	335
	50	3	350
	55	3	365
	63	3	390
75	2	425	
80	1	440	
URT	65	3	510
	75	3	550
	85	3	590
	90	3	610
	110	3	685
	140	3	800
	150	2	840
	160	1	880

Other Protistor® Fuses BS88-4 Fuses Microswitches for BS88-4 Protistor®

勝特力材料 886-3-5753170
勝特力电子(上海) 86-21-34970699
勝特力电子(深圳) 86-755-83298787
Http://www.100y.com.tw

MICROSWITCH SYSTEMS ADAPTED
TO THE FOLLOWING FUSES:

- BS88 - 4 separated trip-indicator
- BS88 - 4 built-in trip-indicator

Main Characteristics

Code	AC Insulation voltage rating (***)	Positive operating voltage/current	Current rating	Current	Interrupting rating						AC voltage withstand test (*)	Impulse voltage test Uimp1.2/50 μs (**)	Fire class according to UL 94
					Non inductive circuit		Inductive circuit : L/R = 25ms						
					30V	110V	250V	30V	110V	250V			
MC 6,3 GR 2-5 N	1000 V	20 V 100 mA	5 A	50/60 Hz	-	5 A	0,3 A	-	3 A	2 A	3.5 kV	-	H.B.
				DC	4 A	0.4 A	-	3 A	0.4 A	-			
MC 36 GR 2-5	1000 V	20 V 100 mA	5 A	50/60 Hz	-	5 A	5 A	-	5 A	5 A	7.5 kV	-	H.B.
				DC	4 A	0.4 A	-	2 A	0.4 A	-			

* Between power circuit and microswitch terminals as per IEC 60 and 694 (50/60 Hz 1 min duration in dry air)

** Between power circuit and microswitch terminals Uimp: impulse voltage as per IEC 947-1

*** Between power circuit and microswitch terminals

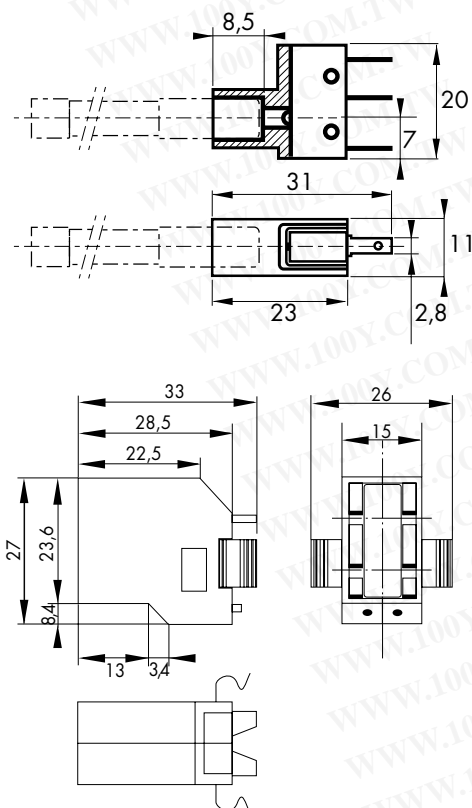

Catalog Number	Ref. Number	Weight (g)	Pack.
MC 6,3 GR 2-5 N (for separate trip-indicator)	Y 310015	10	3

Catalog Number	Ref. Number	Weight (g)	Pack.
MC 36 GR 2-5 (for built-in trip-indicator)	P 092496	10	3