

690/700 Volt

SEMICONDUCTOR PROTECTION FUSES



Ferraz Shawmut 690/700V PSC fuse-links provide maximum flexibility in equipment design and ultimate protection for today's power conversion equipment. These square body fuse-links are available in four different body sizes, each size having seven worldwide acceptable mounting styles. The different mounting styles and body sizes along with a broad range of ampere ratings allow greatest flexibility in equipment design.

The Ferraz Shawmut PSC fuses have been engineered to provide state-of-the-art protection for SCR's, diodes, thyristors, GTO's and IGBT devices. They have pure silver, die-cut elements embedded in solidified sand, which helps control arcing characteristics for low I²t and high interrupting rating. All contact surfaces are silver plated and all hardware is non-magnetic.

All fuse links are equipped with a low voltage trip-indicator. This trip-indicator can operate a field mountable microswitch which is easily mounted directly onto the fuse even while in service.

HIGHLIGHTS:

- Extremely Fast Acting
- Current Limiting
- Very Low I²t
- Worldwide Acceptability Superior Cycling Ability

APPLICATIONS:

- Protection of rectifiers, inverters, DC drives,
- UPS Systems, reduced voltage motor starters, and other equipment in globally accepted applications

Features/Benefits

- **Choice of mounting styles** gives wide choice for equipment design
- **Broad range of ampere ratings** in a given body size for design flexibility
- **IEC 269-4 compliance** for worldwide semiconductor applications

* For Microswitch information see page J8

Ratings

- **AC:** 40-2500A
500-700 VAC
200 kA IR
- **DC:** Consult Factory

Approvals

- UL Recognized Component File E76491
- Sizes 30, 31, 32, 33 tested to IEC 269.4

勝特力材料 886-3-5753170
 勝特力电子(上海) 86-21-34970699
 勝特力电子(深圳) 86-755-83298787
[Http://www.100y.com.tw](http://www.100y.com.tw)



Part Number Designation:

- 6,9 URD:** European/IEC Mounting Style/Approval Tested @ 1.1 V_n
- A070 URD:** North American Mounting Style/Approval Tested @ V_n

*V_n = rated voltage

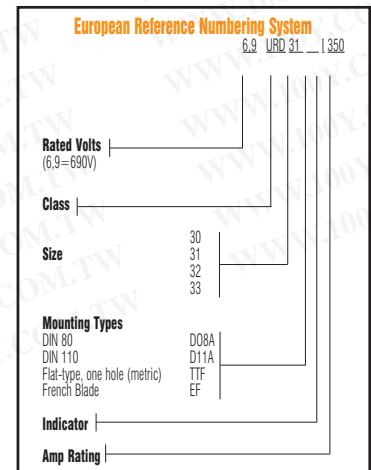
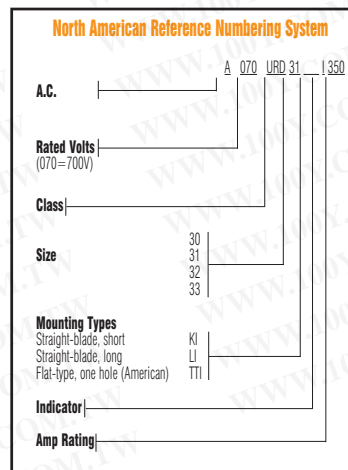

PSC SQUARE BODY

690/700 Volt

SEMICONDUCTOR PROTECTION FUSES

Outline Dimensions

Types D08A and D11A

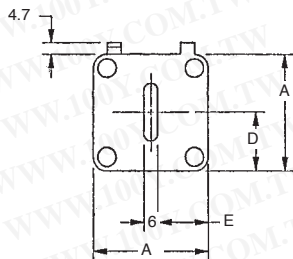
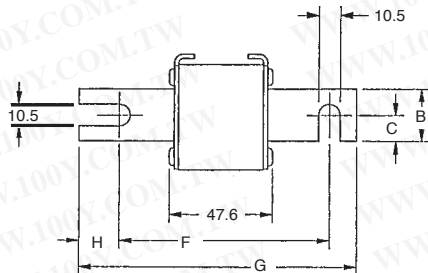

Dimensions

European Blade, Type D08A

BODY SIZE	TYPE	DIMENSIONS - mm						
		A	B	C	D	E	F	G
30	D08	40	25	12.5	21	17	77	110
31		51	25	12.5	25	22.5	77	110
32		60	32	16	30	27	77	110
33		74.5	40	20	37.2	34.25	77	110

European Blade, Type D11A

BODY SIZE	TYPE	DIMENSIONS - mm						
		A	B	C	D	E	F	G
30	D11	40	25	12.5	21	17	101.6	134.6
31		51	25	12.5	25.5	22.5	101.6	134.6
32		60	32	16	30	27	101.6	134.6
33		74.5	40	20	37.2	34.25	101.6	134.6

D

Dimensions

North American Straight Blade, Type KI

Types KI and LI

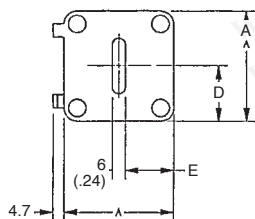
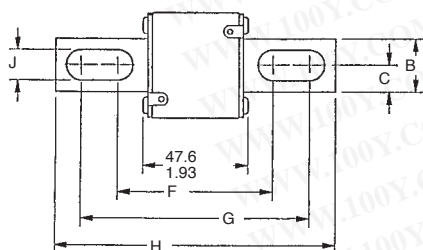

BODY SIZE	TYPE	DIMENSIONS - mm/(in)									
		A	B	C	D	E	F	G	H	J	
30	KI	40 (1.57)	25 (.98)	12.5 (.49)	21 (.83)	18 (.71)	68 (2.68)	107 (4.21)	129 (5.08)	10.5 (.41)	
31		51 (2.01)	25 (.98)	12.5 (.49)	25.5 (1.0)	22.5 (.89)	67.6 (2.66)	107.1 (4.22)	128.8 (5.07)	14.3 (.56)	
32		60 (2.36)	32 (1.26)	16 (.63)	30 (1.18)	27 (1.06)	74.2 (2.92)	109 (4.29)	134 (5.28)	14.6 (.57)	
33		74.5 (2.93)	40 (1.57)	20 (.79)	37.2 (1.46)	34.2 (1.35)	75.4 (2.97)	107.6 (4.24)	134 (5.28)	15.9 (.63)	

North American Straight Blade, Type LI

CATALOG NO.	TYPE	DIMENSIONS - mm/(in)									
		A	B	C	D	E	F	G	H	J	
30	LI	40 (1.57)	25 (.98)	12.5 (.49)	21 (.83)	18 (.71)	87.6 (3.45)	126.6 (4.98)	148.6 (5.85)	10.5 (.41)	
31		51 (2.01)	25 (.98)	12.5 (.49)	25.5 (1.00)	22.5 (.89)	91.6 (3.61)	122.4 (4.82)	148.6 (5.85)	14.6 (.57)	
32		60 (2.36)	32 (1.26)	16 (.63)	30 (1.18)	27 (1.06)	94.2 (3.71)	129 (5.08)	153 (6.02)	14.6 (.57)	
33		74.5 (2.93)	40 (1.57)	20 (.79)	37.2 (1.46)	34.2 (1.35)	94.4 (3.72)	126.6 (4.98)	153 (6.02)	15.9 (.63)	

690/700 Volt

SEMICONDUCTOR PROTECTION FUSES

Outline Dimensions

Types TTI and TTF

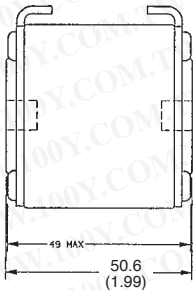
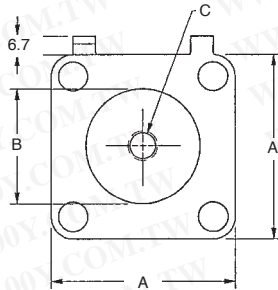

North American Flat Single Hole, Type TTI

BODY SIZE	TYPE	DIMENSIONS - In/(mm)		
		A	B	C
30	TTI	1.57 (40)	1.00 (25)	5/16-18 X .35
31		2.00 (50.8)	1.19 (30.2)	5/16-18 X .35
32		2.37 (60.3)	1.50 (38.1)	3/8-16 X .35
33		2.94 (74.6)	1.81 (46)	1/2-13 X .35

European Flat Single Hole, Type TTF

BODY SIZE	TYPE	DIMENSIONS - In/(mm)		
		A	B	C
30	TTF	40	26	M8 X 1.25 X 6 DP
31		51	30	M8 X 1.25 X 9 DP
32		60	38	M10 X 1.50 X 9 DP
33		74.5	46	M12 X 1.75 X 9 DP

Standard Threaded Studs

SIZE	REF. AND DIMENSION PER PAIR OF STUDS	WEIGHT (g)	MAX STUD MOUNTING TORQUE (Nm)	MAX NUT TIGHTENING TORQUE (Nm)		
				FIG1	FIG 2	FIG 3
30 & 31	S 98 801 (HC M8 X 30 & M 8 X 35)	23	10	13.5	13.5	13.5
32	T 98 802 (HC M 10 X 30 & M 10 X 50)	40		26	26	26
33	V 98 803 (HC M 12 X 35 & M 12 X 50)	60	15	46	46	46
2X32	W 98 804 (HC M 10 X 50)	50		26	26	26
2X33	X 98 805 (HC M 12 X 50)	70		46	46	46

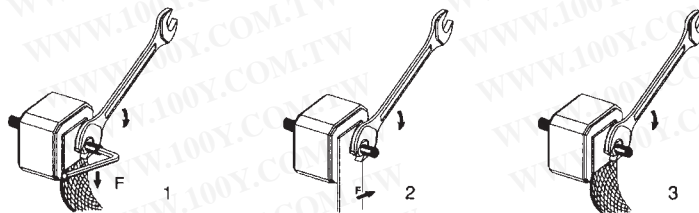

690/700 Volt

SEMICONDUCTOR PROTECTION FUSES

Outline Dimensions

Type EF

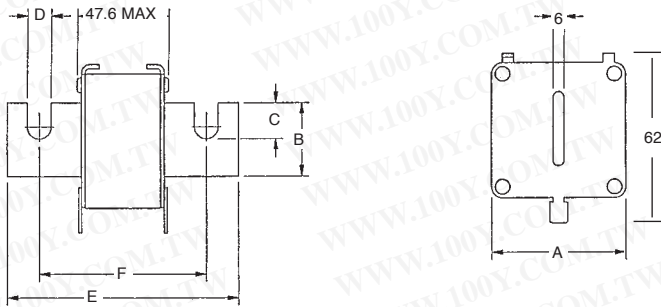

Dimensions

European French Blade, Type EF

BODY SIZE	TYPE	DIMENSIONS - In/(mm)					
		A	B	C	D	E	F
30	EF	40	18	11	9	100	76.6
31		50	25	16	10.5	110	86.5
32		59	32	21.2	13	13	90.8
33		74.5	40	19.5	13	13	91



690/700 Volt

SEMICONDUCTOR PROTECTION FUSES

690 Volt European/IEC Style Ratings and Application Data

Body Size	Amp Rating	Rated Voltage	Melting I ² t (A ² s x 10 ³)	Total I ² t @ 660VAC (A ² s x 10 ³)	**Watts Loss @ Rated Current (W)	DIN 110 Catalog No. Type D11A	DIN 80 Catalog No. Type D08A	French Blade Catalog No. Type EF	Tapped Single Catalog No. Type TTF
30	50	690	0.116	0.68	9	6,9URD30D11A0050	6,9URD30D08A0050	6,9URD30EF0050	6,9URD30TTF0050
	63	690	0.2	1.09	14	6,9URD30D11A0063	6,9URD30D08A0063	6,9URD30EF0063	6,9URD30TTF0063
	80	690	0.33	1.75	19	6,9URD30D11A0080	6,9URD30D08A0080	6,9URD30EF0080	6,9URD30TTF0080
	100	690	0.47	2.5	26	6,9URD30D11A0100	6,9URD30D08A0100	6,9URD30EF0100	6,9URD30TTF0100
	125	690	0.85	4.5	30	6,9URD30D11A0125	6,9URD30D08A0125	6,9URD30EF0125	6,9URD30TTF0125
	160	690	1.6	8.5	37	6,9URD30D11A0160	6,9URD30D08A0160	6,9URD30EF0160	6,9URD30TTF0160
	200	690	3	15.5	42/43	6,9URD30D11A0200	6,9URD30D08A0200	6,9URD30EF0200	6,9URD30TTF0200
	250	690	5.8	30	48/50	6,9URD30D11A0250	6,9URD30D08A0250	6,9URD30EF0250	6,9URD30TTF0250
	315	690	12	62	53/55	6,9URD30D11A0315	6,9URD30D08A0315	6,9URD30EF0315	6,9URD30TTF0315
	350	690	15.5	80	57/60	6,9URD30D11A0350	6,9URD30D08A0350	6,9URD30EF0350	6,9URD30TTF0350
	400	690	23	120	60/65	6,9URD30D11A0400	6,9URD30D08A0400	6,9URD30EF0400	6,9URD30TTF0400
	450	660	26	153	80/88	6,6URD30D11A0450	6,6URD30D08A0450	-	6,6URD30TTF0450
	500	660	41	245	80/88	6,6URD30D11A0500	6,6URD30D08A0500	-	6,6URD30TTF0500
550	660	52	305	80/90	6,6URD30D11A0550	6,6URD30D08A0550	-	6,6URD30TTF0550	
31	200	690	2.6	14	45	6,9URD31D11A0200	6,9URD31D08A0200	6,9URD31EF0200	6,9URD31TTF0200
	250	690	4.7	25	52	6,9URD31D11A0250	6,9URD31D08A0250	6,9URD31EF0250	6,9URD31TTF0250
	315	690	7.5	40	65	6,9URD31D11A0315	6,9URD31D08A0315	6,9URD31EF0315	6,9URD31TTF0315
	350	690	10.5	55	67	6,9URD31D11A0350	6,9URD31D08A0350	6,9URD31EF0350	6,9URD31TTF0350
	400	690	19	100	68	6,9URD31D11A0400	6,9URD31D08A0400	6,9URD31EF0400	6,9URD31TTF0400
	450	690	26.5	140	70	6,9URD31D11A0450	6,9URD31D08A0450	6,9URD31EF0450	6,9URD31TTF0450
	500	690	37	195	70/72	6,9URD31D11A0500	6,9URD31D08A0500	6,9URD31EF0500	6,9URD31TTF0500
	550	690	52	280	70/75	6,9URD31D11A0550	6,9URD31D08A0550	6,9URD31EF0550	6,9URD31TTF0550
	630	690	75	390	75/85	6,6URD31D11A0630	6,6URD31D08A0630	6,9URD31EF0630	6,9URD31TTF0630
	700	690	95	490	85/95	6,9URD31D11A0700	6,9URD31D08A0700	6,9URD31EF0700	6,9URD31TTF0700
800	660	140	815	105/120	6,6URD31D11A0800	6,6URD31D08A0800	-	6,6URD31TTF0800	
32	400	690	15	80	72/75	6,9URD32D11A0400	6,9URD32D08A0400	6,9URD32EF0400	6,9URD32TTF0400
	450	690	22	115	77/80	6,9URD32D11A0450	6,9URD32D08A0450	6,9URD32EF0450	6,9URD32TTF0450
	500	690	28	145	85/90	6,9URD32D11A0500	6,9URD32D08A0500	6,9URD32EF0500	6,9URD32TTF0500
	550	690	37	195	90/95	6,9URD32D11A0550	6,9URD32D08A0550	6,9URD32EF0550	6,9URD32TTF0550
	630	690	54	280	95/105	6,9URD32D11A0630	6,9URD32D08A0630	6,9URD32EF0630	6,9URD32TTF0630
	700	690	76	400	100/110	6,9URD32D11A0700	6,9URD32D08A0700	6,9URD32EF0700	6,9URD32TTF0700
	800	690	115	600	110/120	6,9URD32D11A0800	6,9URD32D08A0800	6,9URD32EF0800	6,9URD32TTF0800
	900	660	170	900	110/125	6,6URD32D11A0900	6,6URD32D08A0900	6,6URD32EF0900	6,6URD32TTF0900
	1000	660	240	1250	115/135	6,6URD32D11A1000	6,6URD32D08A1000	6,6URD32EF1000	6,6URD32TTF1000
	1100	600	270	1620	140/165	-	6URD32D08A1100	-	6URD32TTF1100
	1250	500	410	1940	150/180	-	5URD32D08A1250	-	5URD32TTF1250
33	500	690	19	100	105	6,9URD33D11A0500	6,9URD33D08A0500	6,9URD33EF0500	6,9URD33TTF0500
	550	690	27	140	105/110	6,9URD33D11A0550	6,9URD33D08A0550	6,9URD33EF0550	6,9URD33TTF0550
	630	690	40	130	110/120	6,9URD33D11A0630	6,9URD33D08A0630	6,9URD33EF0630	6,9URD33TTF0630
	700	690	55	300	115/125	6,9URD33D11A0700	6,9URD33D08A0700	6,9URD33EF0700	6,9URD33TTF0700
	800	690	95	490	120/130	6,9URD33D11A0800	6,9URD33D08A0800	6,9URD33EF0800	6,9URD33TTF0800
	900	690	135	700	120/135	6,9URD33D11A0900	6,9URD33D08A0900	6,9URD33EF0900	6,9URD33TTF0900
	1000	690	170	900	135/155	6,9URD33D11A1000	6,9URD33D08A1000	6,9URD33EF1000	6,9URD33TTF1000
	1100	690	240	1260	135/160	6,9URD33D11A1100	6,9URD33D08A1100	6,9URD33EF1100	6,9URD33TTF1100
	1250	660	350	1850	150/180	6,6URD33D11A1250	6,6URD33D08A1250	6,6URD33EF1250	6,6URD33TTF1250
	1400	660	480	2500	160/200	6,6URD33D11A1400	6,6URD33D08A1400	6,6URD33EF1400	6,6URD33TTF1400
	1500	600	500	-	220	6URD33D11A1500	6,6URD33D08A1500	-	6URD33TTF1500
	1600	600	555	-	210/240	6URD33D11A1600	6URD33D08A1600	-	6URD33TTF1600
	1800	600	720	-	225/260	6URD33D11A1800	6URD33D08A1800	-	6URD33TTF1800
	2000	550	950	-	250/290	-	-	-	5,5URD33TTF2000
	2250	500	1250	-	280/330	-	-	-	5URD33TTF2250
	2500	450	1870	-	280/330	-	-	-	4,5URD33TTF2500

** Watts loss data is published for both blade and tapped style mounting configurations. When two watts loss values are shown this represents tapped/blade values respectively.

690/700 Volt

SEMICONDUCTOR PROTECTION FUSES

700 Volt North American Style Ratings and Application Data

Body Size	Amp Rating	Rated Voltage	Melting I ² t (A ² s x 10 ³)	Total I ² t @ Rated Voltage (A ² s x 10 ³)	**Watts Loss @ Rated Current (W)	Long Blade Catalog No. Type LI	Short Blade Catalog No. Type KI	Tapped Terminal Catalog No. Type TTI
30	63	700	0.2	1.2	14	A070URD30LI0063	A070URD30KI0063	A070URD30TTI0063
	80	700	0.33	1.9	19	A070URD30LI0080	A070URD30KI0080	A070URD30TTI0080
	100	700	.47	2.7	26	A070URD30LI0100	A070URD30KI0100	A070URD30TTI0100
	125	700	0.85	4.9	30	A070URD30LI0125	A070URD30KI0125	A070URD30TTI0125
	160	700	1.6	9.2	37	A070URD30LI0160	A070URD30KI0160	A070URD30TTI0160
	200	700	3	16.7	42/43	A070URD30LI0200	A070URD30KI0200	A070URD30TTI0200
	250	700	5.8	32.4	48/50	A070URD30LI0250	A070URD30KI0250	A070URD30TTI0250
	315	700	12	67	53/55	A070URD30LI0315	A070URD30KI0315	A070URD30TTI0315
	350	700	15.5	86	57/60	A070URD30LI0350	A070URD30KI0350	A070URD30TTI0350
	400	700	23	130	60/65	A070URD30LI0400	A070URD30KI0400	A070URD30TTI0400
	450	700	26	165	80/88	A070URD30LI0450	A070URD30KI0450	A070URD30TTI0450
	500	700	41	264	80/88	A070URD30LI0500	A070URD30KI0500	A070URD30TTI0500
550	700	52	330	80/90	A070URD30LI0550	A070URD30KI0550	A070URD30TTI0550	
31	200	700	2.5	14.6	45	A070URD31LI0200	A070URD31KI0200	A070URD31TTI0200
	250	700	4.7	27	52	A070URD31LI0250	A070URD31KI0250	A070URD31TTI0250
	315	700	7.5	43	65	A070URD31LI0315	A070URD31KI0315	A070URD31TTI0315
	350	700	10.5	59	67	A070URD31LI0350	A070URD31KI0350	A070URD31TTI0350
	400	700	19	110	68	A070URD31LI0400	A070URD31KI0400	A070URD31TTI0400
	450	700	26.5	150	70	A070URD31LI0450	A070URD31KI0450	A070URD31TTI0450
	500	700	37	210	70/72	A070URD31LI0500	A070URD31KI0500	A070URD31TTI0500
	550	700	52	300	70/75	A070URD31LI0550	A070URD31KI0550	A070URD31TTI0550
	630	700	75	421	75/85	A070URD31LI0630	A070URD31KI0630	A070URD31TTI0630
	700	700	95	530	85/95	A070URD31LI0700	A070URD31KI0700	A070URD31TTI0700
800	700	140	880	105/120	A070URD31LI0800	A070URD31KI0800	A070URD31TTI0800	
32	400	700	15	86	72/75	A070URD32LI0400	A070URD32KI0400	A070URD32TTI0400
	450	700	22	124	77/80	A070URD32LI0450	A070URD32KI0450	A070URD32TTI0450
	500	700	28	157	85/90	A070URD32LI0500	A070URD32KI0500	A070URD32TTI0500
	550	700	37	211	90/95	A070URD32LI0550	A070URD32KI0550	A070URD32TTI0550
	630	700	54	302	95/105	A070URD32LI0630	A070URD32KI0630	A070URD32TTI0630
	700	700	76	432	100/110	A070URD32LI0700	A070URD32KI0700	A070URD32TTI0700
	800	700	115	648	110/120	A070URD32LI0800	A070URD32KI0800	A070URD32TTI0800
	900	700	170	972	110/125	A070URD32LI900	A070URD32KI900	A070URD32TTI900
	1000	700	240	1350	115/135	A070URD32LI1000	A070URD32KI1000	A070URD32TTI1000
	1100	650	270	1620	140/165	A065URD32LI1100	-	A065URD32TTI1100
	1250	600	410	2100	150/180	A060URD32LI1250	-	A060URD32TTI1250
	1400	550	555	2600	160/190	A055URD32LI1400	-	A055URD32TTI1400
	1600	550	870	4000	165/195	A055URD32LI1600	-	A055URD32TTI1600
	1800	500	1050	4400	195/330	A050URD32LI1800	-	A050URD32TTI1800
33	500	700	19	108	105	A070URD33LI0500	A070URD33KI0500	A070URD33TTI0500
	550	700	27	151	105/110	A070URD33LI0550	A070URD33KI0550	A070URD33TTI0550
	630	700	40	227	110/120	A070URD33LI0630	A070URD33KI0630	A070URD33TTI0630
	700	700	55	324	115/125	A070URD33LI0700	A070URD33KI0700	A070URD33TTI0700
	800	700	95	529	120/130	A070URD33LI0800	A070URD33KI0800	A070URD33TTI0800
	900	700	135	760	120/135	A070URD33LI0900	A070URD33KI0900	A070URD33TTI0900
	1000	700	170	970	135/155	A070URD33LI1000	A070URD33KI1000	A070URD33TTI1000
	1100	700	240	1360	135/160	A070URD33LI1100	A070URD33KI1100	A070URD33TTI1100
	1250	700	350	2000	150/180	A070URD33LI1250	A070URD33KI1250	A070URD33TTI1250
	1400	700	480	2700	160/200	A070URD33LI1400	A070URD33KI1400	A070URD33TTI1400
	1600	650	555	3250	210/240	A065URD33LI1600	A065URD33KI1600	A065URD33TTI1600
	1800	650	720	4330	225/260	A065URD33LI1800	-	A065URD33TTI1800
	2000	600	950	5000	250/290	A060URD33LI2000	-	A060URD33TTI2000
	2250	550	1250	5900	280/330	A055URD33LI2250	-	A055URD33TTI2250
	2500	500	1870	7600	280/330	A050URD33LI2500	-	A050URD33TTI2500

** Watts loss data is published for both blade and tapped style mounting configurations. When two watts loss values are shown this represents tapped/blade values respectively.



勝特力材料 886-3-5753170
 勝特力电子(上海) 86-21-34970699
 勝特力电子(深圳) 86-755-83298787
[Http://www.100y.com.tw](http://www.100y.com.tw)