

42BYG1.8度 两相步进电机

勝特力材料 886-3-5753170
勝特力电子(上海) 86-21-54151736
勝特力电子(深圳) 86-755-83298787
[Http://www.100y.com.tw](http://www.100y.com.tw)

一般规格

(项目)	(规格)
步进角精度	±5% (full step, no load)
电阻精度	±10%
电感精度	±20%
温升	80°CMax. (reted current, 2 phase on)
环境温度	-10°C - +50°C
绝缘等级	100MΩMin. 500 VDC
介电强度	500VAC for one minute
转轴径向跳动	0.06Max. (450 g-load)
转轴轴向跳动	0.08Max. (450 g-load)



技术规格

型号	电压	电流	电阻	电感	最大静转矩	转子转动惯量	重量	机身长			
(单出轴)	(双出轴)	V	A	Ω	MH	Oz-in	Kg-cm	g-cm ²	Kg	MM	
17H130H-01A	17H130H-01B	4	0.95	4.2	2.5						
17H130H-02A	17H130H-02B	9.6	0.4	24	15	22	1.58	6	35	0.22	33
17H130H-03A	17H130H-03B	12	0.31	38.5	21						
17H130H-04A	17H130H-04B	2.8	1.33	2.1	2.5	30	2.2	4			
17H150H-01A	17H150H-01B	4	1.2	3.3	3.2						
17H150H-02A	17H150H-02B	6	0.8	7.5	6.7	36	2.59	6	54	0.28	39
17H150H-03A	17H150H-03B	12	0.4	30	30						
17H150H-04A	17H150H-04B	2.8	1.68	1.65	3.2	50	3.6	4			
17H185H-01A	17H185H-01B	4	1.2	3.3	2.8						
17H185H-02A	17H185H-02B	6	0.8	7.5	6.3	44	3.17	6	68	0.35	47
17H185H-03A	17H185H-03B	12	0.4	30	25						
17H185H-04A	17H185H-04B	2.8	1.68	1.65	2.8	62	4.4	4			

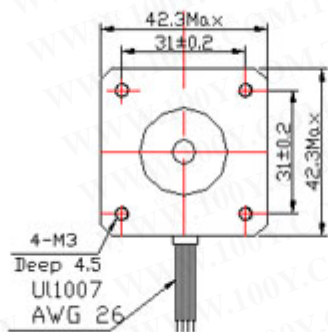
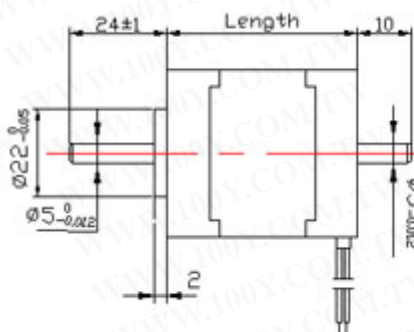

6 LEADES

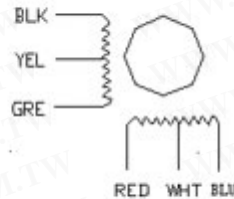

4 LEADES

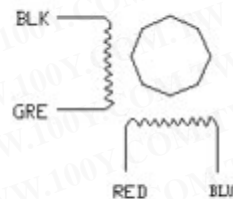

规格

	Inches	mm
17H130H-xx	1.30	33
17H150H-xx	1.50	38

(电机选取项)
 (电机: 特殊长度、线圈、轴承和螺纹)
 (轴: 平面、齿轮、键、长度)
 (接线: 类型、颜色、长度、接插件)

MODEL:17H130H-01 CURRENT:0.95A
VOLTAGE:24VDC FULL STEP

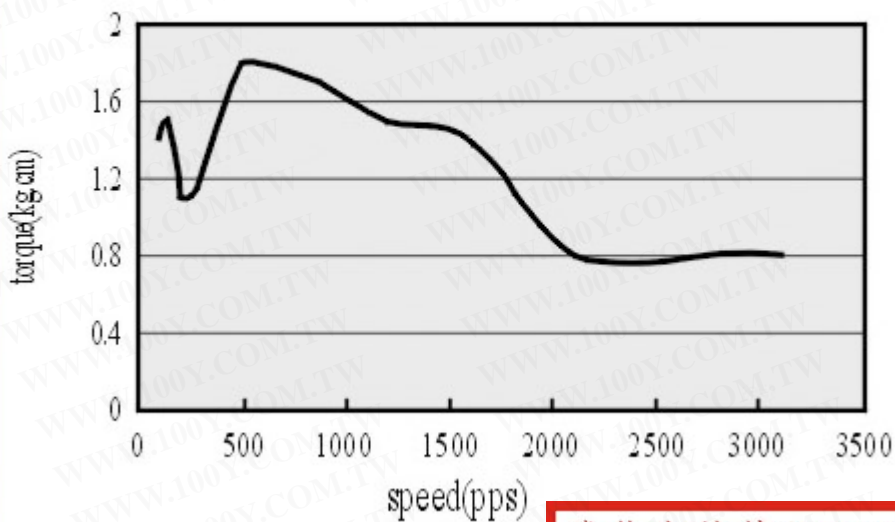

勝特力材料 886-3-5753170
勝特力电子(上海) 86-21-54151736
勝特力电子(深圳) 86-755-83298787
[Http://www.100y.com.tw](http://www.100y.com.tw)

MODEL:17H130H-02 CURRENT:0.4A
VOLTAGE:24VDC FULL STEP

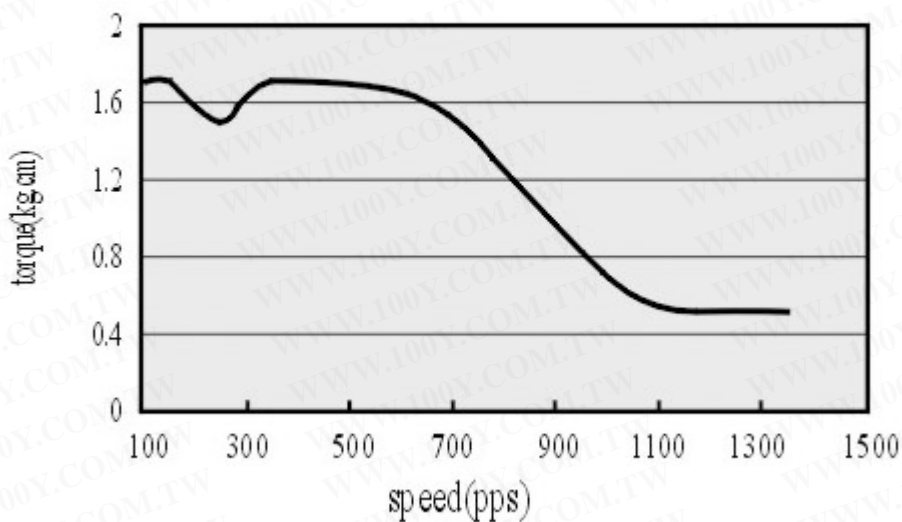

MODEL:17H130H-03 CURRENT:0.31A
VOLTAGE:24VDC FULL STEP

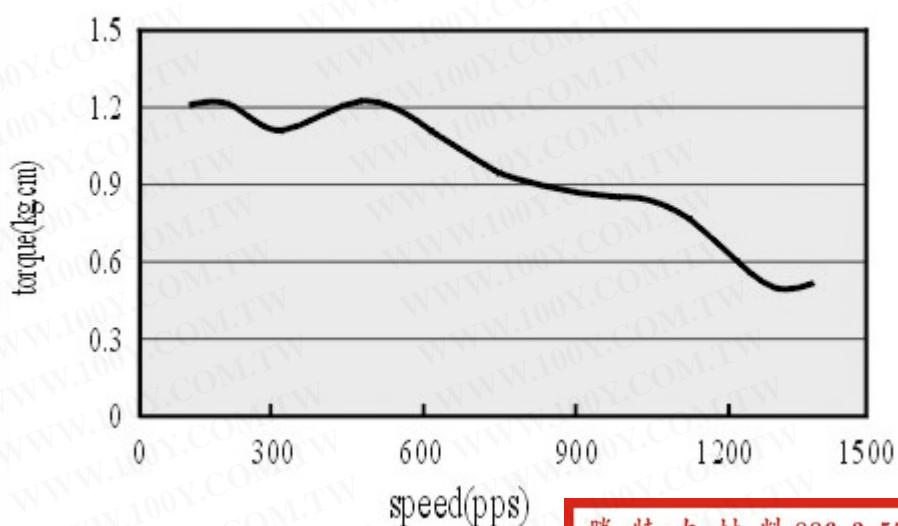

勝特力材料 886-3-5753170
勝特力电子(上海) 86-21-54151736
勝特力电子(深圳) 86-755-83298787
[Http://www.100y.com.tw](http://www.100y.com.tw)

MODEL:17H130H-04 CURRENT:1.33A
VOLTAGE:24VDC FULL STEP

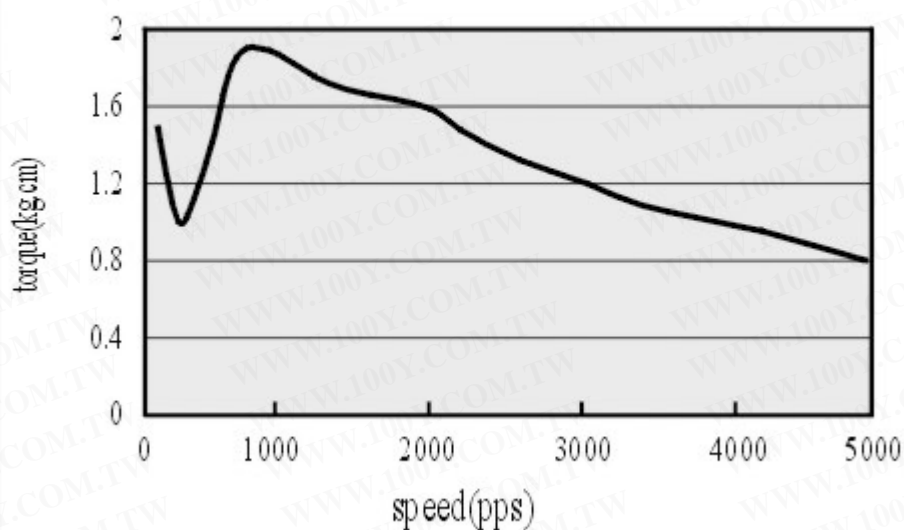

MODEL:17H150H-01 CURRENT:1.2A
VOLTAGE:24VDC FULL STEP

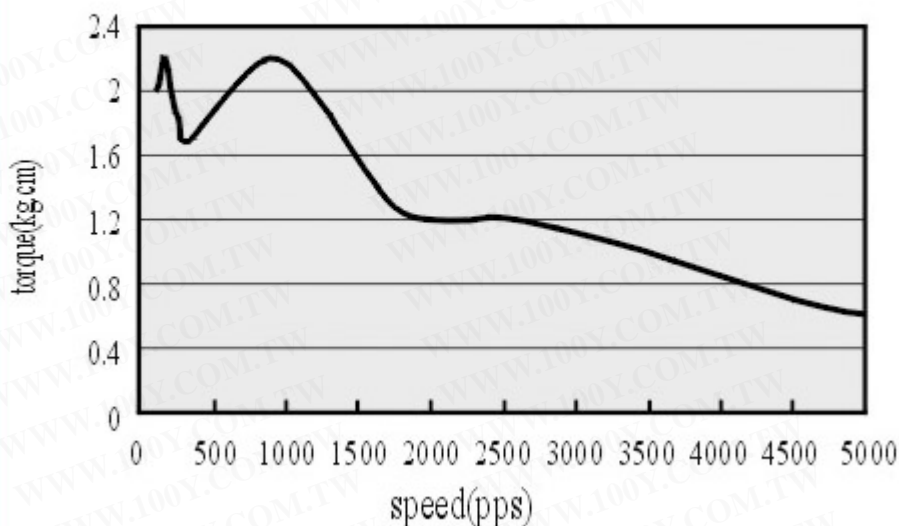

勝特力材料 886-3-5753170
勝特力电子(上海) 86-21-54151736
勝特力电子(深圳) 86-755-83298787
[Http://www.100y.com.tw](http://www.100y.com.tw)

MODEL:17H150H-02 CURRENT:0.8A
VOLTAGE:24VDC FULL STEP



MODEL:17H150H-03 CURRENT:0.4A
VOLTAGE:24VDC FULL STEP

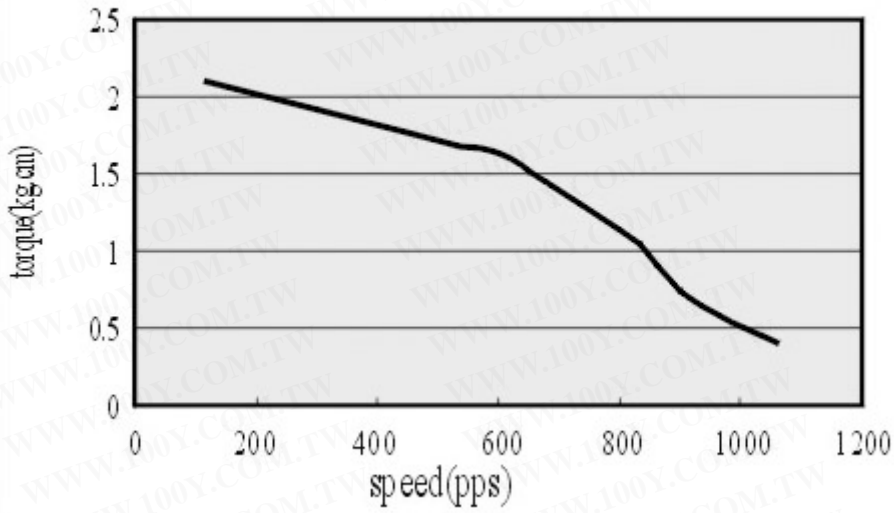

勝特力材料 886-3-5753170
勝特力电子(上海) 86-21-54151736
勝特力电子(深圳) 86-755-83298787
[Http://www.100y.com.tw](http://www.100y.com.tw)

MODEL:17H150H-04 CURRENT:1.63A
VOLTAGE:24VDC FULL STEP

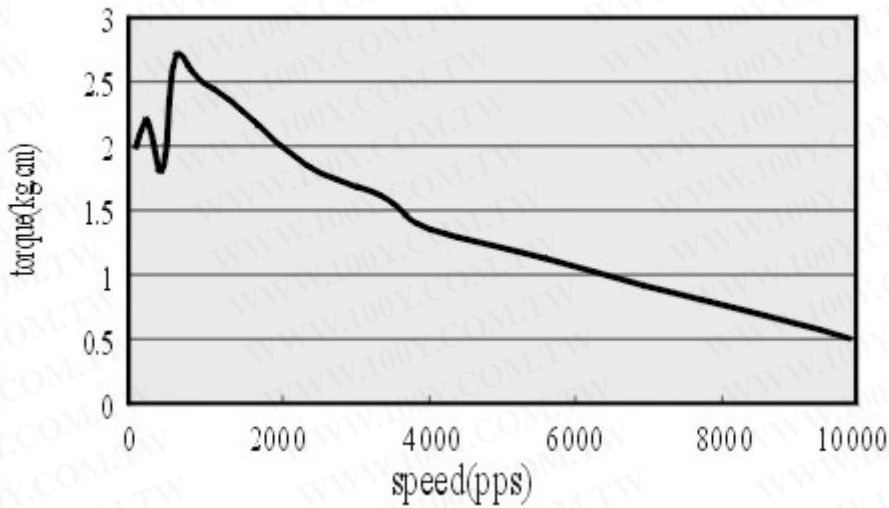

MODEL:17H185H-01 CURRENT:1.2A
VOLTAGE:24VDC FULL STEP

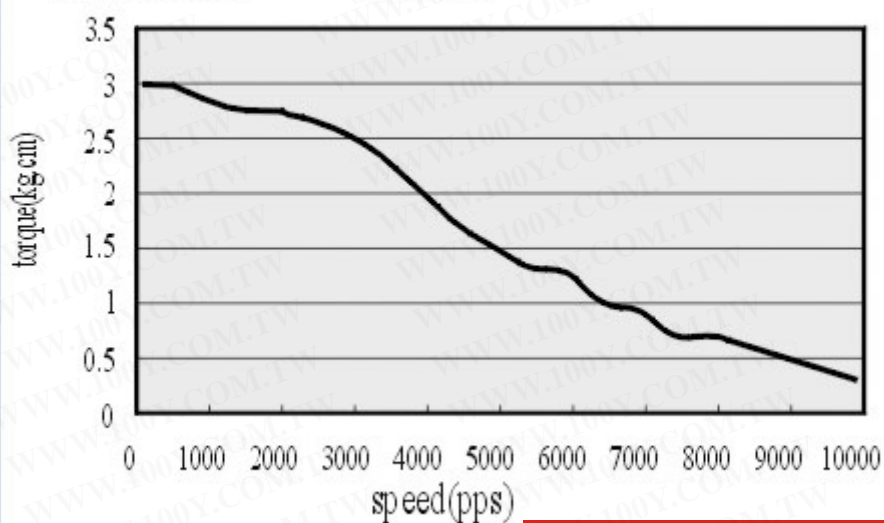

勝特力材料 886-3-5753170
勝特力电子(上海) 86-21-54151736
勝特力电子(深圳) 86-755-83298787
[Http://www.100y.com.tw](http://www.100y.com.tw)

MODEL:17H185H-02 CURRENT:0.8A
VOLTAGE:24VDC FULL STEP

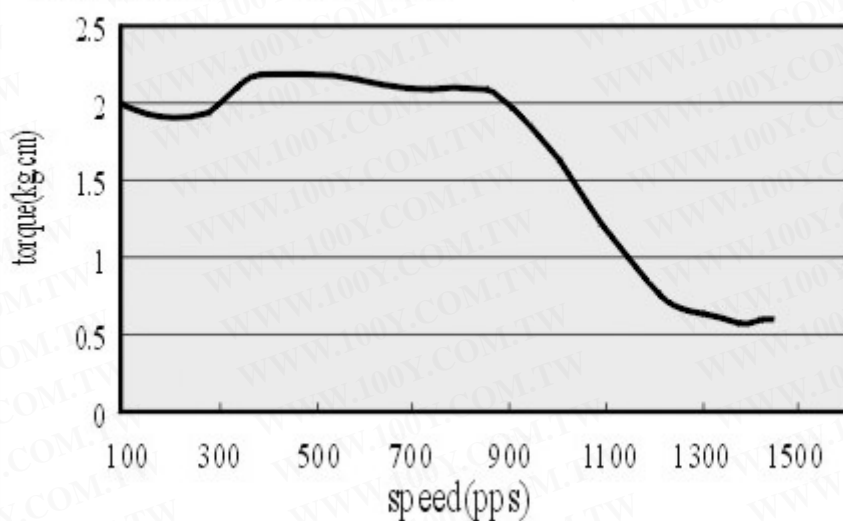

MODEL:17H185H-03 CURRENT:0.4A
VOLTAGE:24VDC FULL STEP

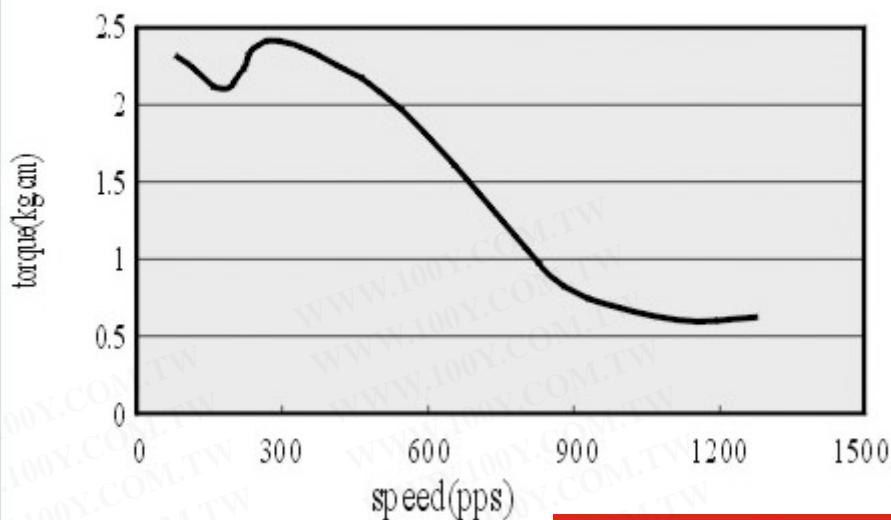

勝特力材料 886-3-5753170
勝特力电子(上海) 86-21-54151736
勝特力电子(深圳) 86-755-83298787
[Http://www.100y.com.tw](http://www.100y.com.tw)

MODEL:17H185H-04 CURRENT:1.68A
VOLTAGE:24VDC FULL STEP

