



勝特力材料 886-3-5753170  
 勝特力电子(上海) 86-21-54151736  
 勝特力电子(深圳) 86-755-83298787  
[Http://www.100y.com.tw](http://www.100y.com.tw)

# SUNON

## SPECIFICATION FOR APPROVAL

**CUSTOMER** :  
**MOTOR TYPE** :   
**DESCRIPTION** : **MagLev Motor Fan**  
**DIMENSIONS** : **30X30X6 mm**  
**MODEL** : **KDE0503PEV3-8**  
**P/N** : **MS.N.GN**  
**SUNON SPEC. NO.** :  
**CUSTOMER APPROVAL NO.** :  
**APPROVED BY CUSTOMER** :  
**(AUTHORIZED)**

<b>DRAWN</b>	<i>Apple</i> 9/17	<b>CHECKED</b>	 9/18	<b>APPROVED</b>		<b>SPEC.NO</b>	<b>D03016130G-00</b>
						<b>ISSUE DATE</b>	<b>09.17.2007</b>
						<b>EDITION</b>	<b>0</b>
						<b>REVISION DATE</b>	
						<b>E.SPEC</b>	<b>EM30013</b>

**DC BRUSHLESS FAN****MODEL : KDE0503PEV3-8****P/N : MS.N.GN**

勝特力材料 886-3-5753170  
勝特力电子(上海) 86-21-54151736  
勝特力电子(深圳) 86-755-83298787  
[Http://www.100y.com.tw](http://www.100y.com.tw)

**CHARACTERISTICS**

- 1. Motor Design** : **Patented single-coil DC brushless 8 pole motor design.**
- 2. Insulation Resistance** : **More than 500M ohm between internal stator and lead wire(+) measured at DC 500V.**
- 3. Dielectric Strength** : **Applied AC 500V for one minute or AC 600V for 2 seconds between housing and lead wire(+)**
- 4. Noise Level** : **Measured in a semi-anechoic chamber with background noise level below 15 dB(A). The fan is running in free air with the microphone at a distance of one meter from the fan intake.**
- 5. Input Power, Current & Speed** : **Measured after continuous 10 minute operation at rated voltage in clean air, and at ambient temperature of 25 degrees C.**
- 6. Tolerance** : **±15% on rated power and current.**
- 7. Air Performance** : **Measured by a double chamber. The values are recorded when the fan speed has stabilized at rated voltage.**

## SPECIFICATIONS

**MODEL: KDE0503PEV3-8**

**P/N : MS.N.GN**

勝特力材料 886-3-5753170  
 勝特力电子(上海) 86-21-54151736  
 勝特力电子(深圳) 86-755-83298787  
[Http://www.100y.com.tw](http://www.100y.com.tw)

- 1-1. Rated Voltage : 5 VDC**
- 1-2. Operating Voltage Range : 3.5~6 VDC**
- 1-3. Starting Voltage : 3.5 VDC (25 deg. C POWER ON/OFF)**
- 1-4. Rated Speed : 5500 RPM  $\pm$  1000 RPM**
- 1-5. Air Delivery : 2.4 CFM**
- 1-6. Static Pressure : 0.06 Inch-H<sub>2</sub>O**
- 1-7. Rated Current : 0.07 AMP**
- 1-8. Rated Power : 0.35 WATTS**
- 1-9. Noise Level : 16.5 dB(A)**
- 1-10. Direction of Rotation : Counter-clockwise viewed from front of fan blade**
- 1-11. Operating Temperature : -10 to +70 deg. C**
- 1-12. Storage Temperature : -40 to +70 deg. C**
- 1-13. Bearing System : Vapo bearing system**
- 1-14. Weight : 6 g**
- 1-15. Safety : UL/CUR/TUV/CE Approvals**
- 1-16. Protection :  Automatic Restart Capability**  
 Note: In a situation where the fan is locked by an external force while the electricity is on, an increase in coil temperature will be prevented by temporarily turning off the electrical power to the motor. The fan will automatically restart when the locked rotor condition is released.  
 Polarity Protection

**MODEL : KDE0503PEV3-8**

**P/N : MS.N.GN**

**PERFORMANCE CURVES**

勝特力材料 886-3-5753170  
勝特力电子(上海) 86-21-54151736  
勝特力电子(深圳) 86-755-83298787  
[Http://www.100y.com.tw](http://www.100y.com.tw)

**STATIC PRESSURE**

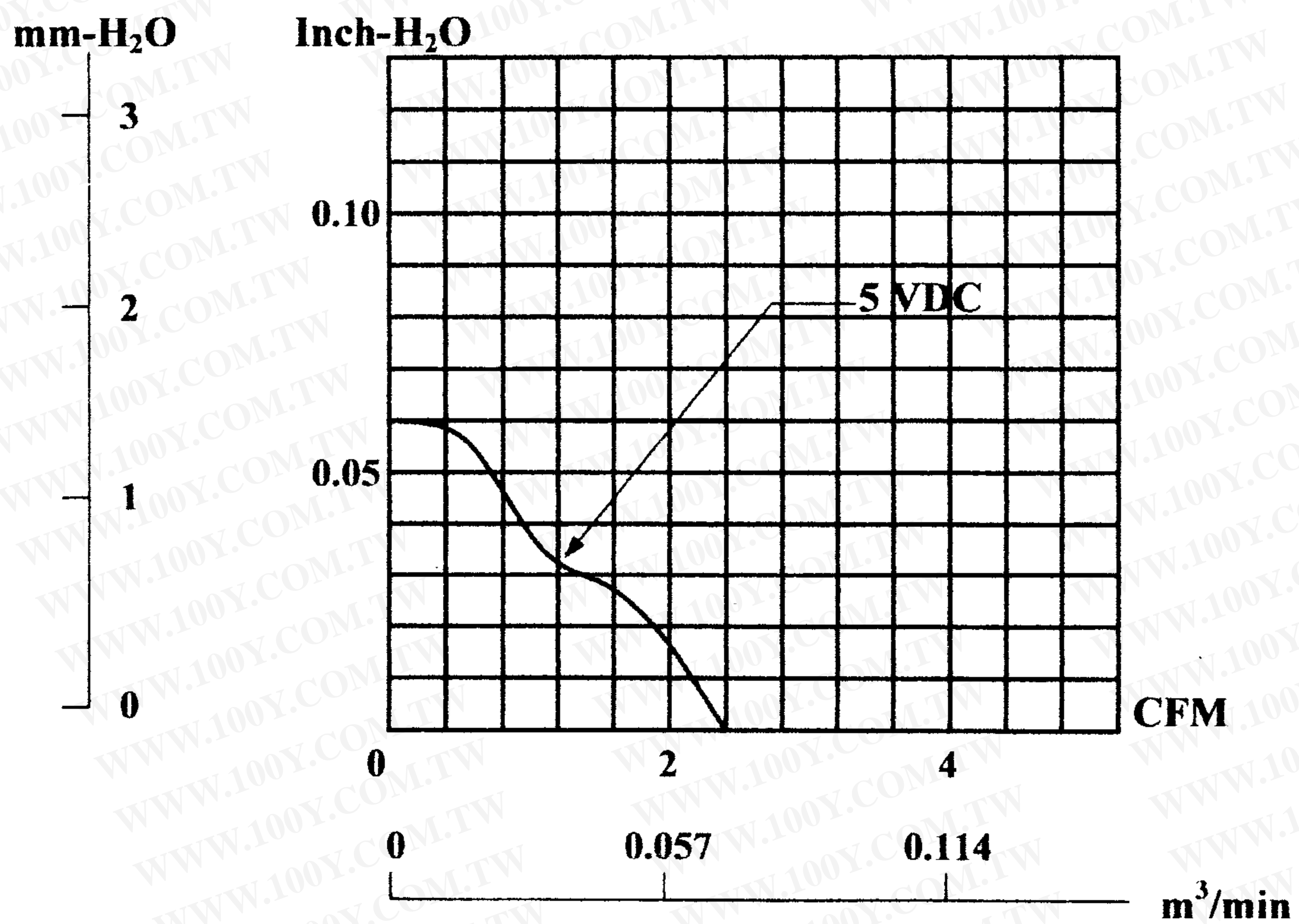

**MATERIAL**

- 2-1. Frame : Thermoplastic PBT of UL 94V-0
- 2-2. Impeller : Thermoplastic PBT of UL 94V-0
- 2-3. Bobbin : Thermoplastic PBT of UL 94V-0
- 2-4. Lead Wire : UL3265,28 awg,+RED,-BLACK

**DIMENSIONS**

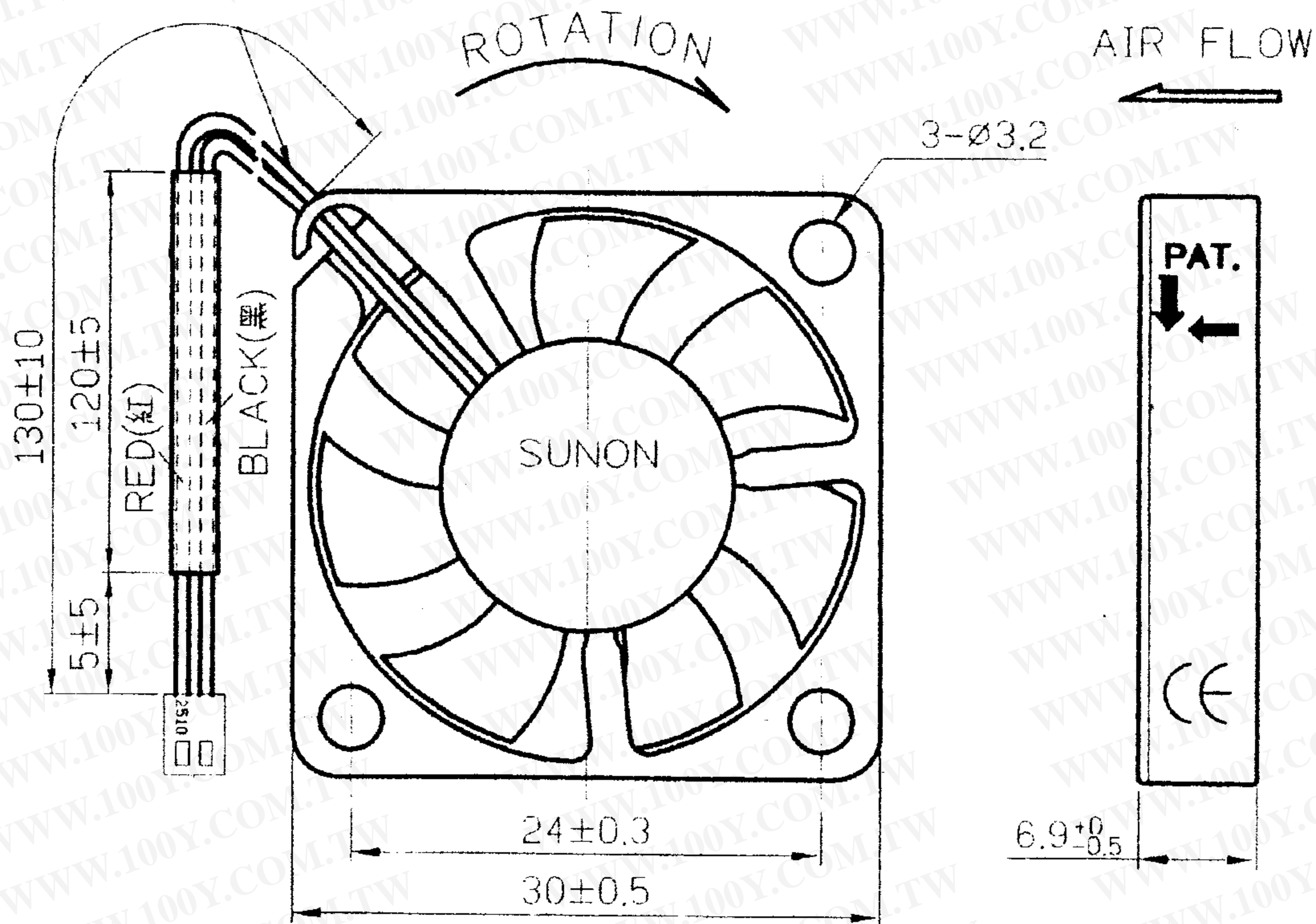

1. Air Flow Direction: Toward label side.
2. Best Mounting Direction: Any orientation.

UNITS: mm

**LABEL**

勝特力材料 886-3-5753170  
 勝特力电子(上海) 86-21-54151736  
 勝特力电子(深圳) 86-755-83298787  
[Http://www.100y.com.tw](http://www.100y.com.tw)

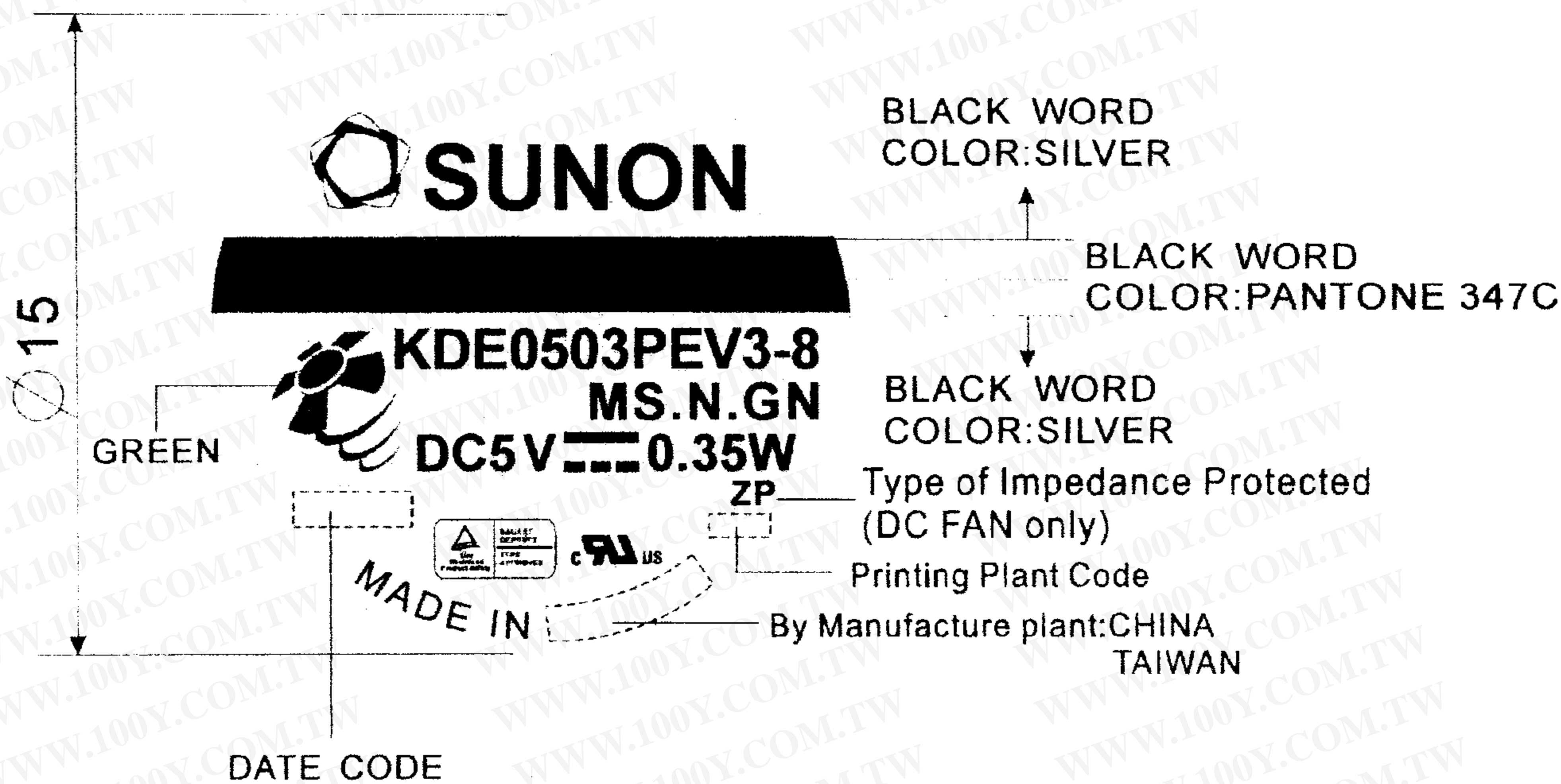

BLACK WORD  
COLOR: SILVER

BLACK WORD  
COLOR: PANTONE 347C

BLACK WORD  
COLOR: SILVER

Type of Impedance Protected  
(DC FAN only)

Printing Plant Code

By Manufacture plant: CHINA  
TAIWAN

DATE CODE

GREEN

MADE IN

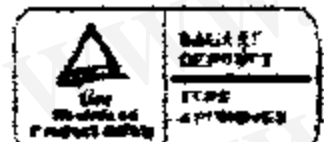

ZP

**KDE0503PEV3-8**  
**MS.N.GN**  
**DC5V 0.35W**

**SUNON**

$\varnothing 15$

**PACKAGE**

勝特力材料 886-3-5753170  
 勝特力电子(上海) 86-21-54151736  
 勝特力电子(深圳) 86-755-83298787  
[Http://www.100y.com.tw](http://www.100y.com.tw)

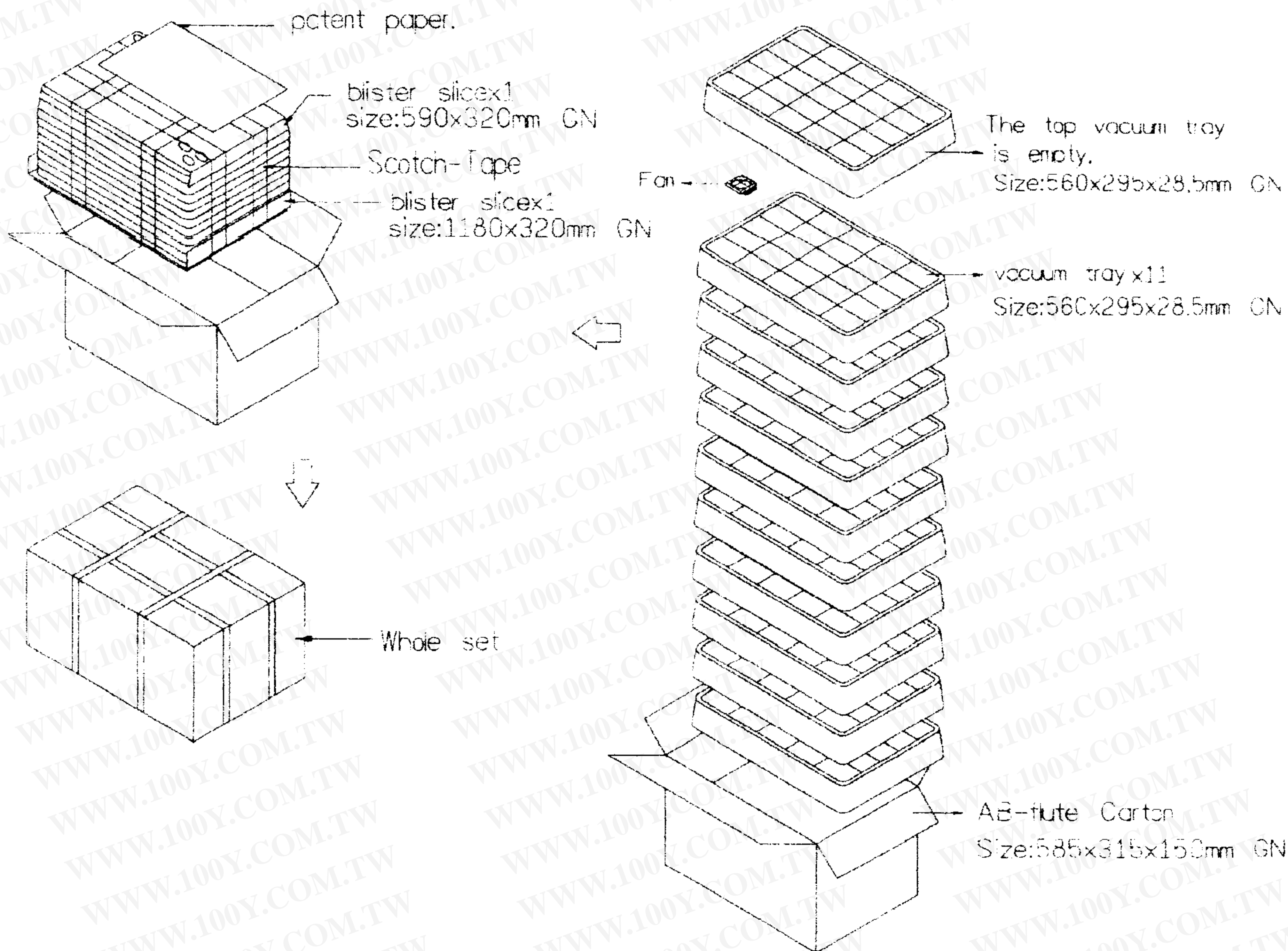

The raw material or component of our products shall not contain hazardous substances which were stated in Sunon's "Index of Inspection technology and criteria for environment loading substances in fan"

CTN SIZE	QTY/ CTN	(Cu/ft) Measurement
585x315x150mm GN	250	0.98

## Notes

### I . SAFETY

- 1. DO NOT use or operate this fan in excess of the limitations set forth in this specification. SUNON is not be responsible for the non-performance of this fan and/or any damages resulting from its use, if it is not used or operated in accordance with the specifications.**
- 2. SUNON recommends adding a protection circuit to the product or application in which this fan is installed, such as a thermo-fuse, or current-fuse or thermo-protector. The failure to use such a device may result in smoke, fire, electric shock by insulation degradation in cases of motor lock, motor lead short circuit, overload, or over voltage, and/or other failure.**
- 3. SUNON recommends installing a protection device to the product or application in which this fan is installed if there is a possibility of reverse-connection between VDC (+) and GND (-). The failure to install such a device may result in smoke, fire, and/or destruction, although these conditions may not manifest immediately.**
- 4. This fan must be installed and used in compliance with all applicable safety standards and regulations.**
- 5. Use proper care when handling and/or installing this fan. Improper handling or installation of this fan may cause damage that could result in unsafe conditions.**
- 6. Use proper care during installation and/or wiring. Failure to use proper care may cause damage to certain components of the fan including, but not limited to, the coil and lead wires, which could result in smoke and/or fire.**
- 7. DO NOT use power or ground PWM to control the fan speed. If the fan speed needs to be adjusted, please contact Sunon to customize the product design for your application.**

## **Notes**

### **II. SPECIFICATION MODIFICATION**

- 1. SUNON offers engineering assistance on fan installation and cooling system design.**
- 2. All changes, modifications and/or revisions to the specifications, if any, are incorporated in the attached specifications.**
- 3. No changes, modifications and/or revisions to these specifications are effective absent agreement, by both Sunon and the customer, in writing.**
- 4. This fan will be shipped in accordance with the attached specification unless SUNON and the customer have agreed otherwise, in writing, as specified in Paragraph 3, above.**

### **III. OTHER**

- 1. When building your device, please examine thoroughly any variation of EMC, temperature rise, life data, quality, etc. of this product by shock/drop/vibration testing, etc. If there are any problems or accidents in connection with this product, it should be mutually discussed and examined.**
- 2. Use proper care when handling this fan. Components such as fan holders or bearings may be damaged, if touched with fingers or other objects. Additionally, static electricity (ESD) may damage the internal circuits of the fan.**
- 3. DO NOT operate this fan in proximity to hazardous materials such as organic silicon, cyanogens, formalin, phenol, or corrosive gas environments including, but not limited to, H<sub>2</sub>S, SO<sub>2</sub>, NO<sub>2</sub>, or Cl<sub>2</sub>.**
- 4. SUNON recommends that you protect this fan from exposure to outside elements such as dust, condensation, humidity or insects. Exposure of this fan to outside elements such as dust, condensation, humidity or insects may affect its performance and may cause safety hazards. SUNON does not warrant against damage to the product caused by outside elements.**

## Notes

5. **This fan must be installed properly and securely. Improper mounting may cause harsh resonance, vibration, and noise.**
6. **Fan guards may prevent injury during handling or installation of the fan and are available for sale with this fan.**
7. **Unless otherwise noted, all testing of this fan is conducted at 25°C ambient temperature and sixty-five percent (65%) relative humidity.**
8. **DO NOT store this fan in an environment with high humidity. This fan must be stored in accordance with the attached specifications regarding storage temperature. If this fan is stored for more than 6 months, SUNON recommends functional testing before using.**
9. **SUNON reserves the right to use components from multiple sources at its discretion. The use of components from other sources will not affect the specifications as described herein.**
10. **The “Life Expectancy” of this fan has not been evaluated for use in combination with any end application. Therefore, the Life Expectancy Test Reports (L10 and MTTF Report) that relate to this fan are only for reference.**

## Declaration of RoHS

### Control declaration of environment-related substances/materials

1. In accordance with the Restriction of Hazardous Substances (RoHS) Directive, Sunon product with P/N: GN models have complied with law and discipline not to employ the forbidden substances, and restrict the allowable concentration of some limited substances deliberately in our components.

No	Substance	Criteria
1	CFCs & HCFCs (ozone depleting substances)	Forbidden
2	Chlorinated Organic Solvent	Forbidden
3	Plastic (Frame, Impeller, wire harness, etc.)	<100ppm
	Solder	<1000ppm
	Steel alloy	<3500ppm
	Aluminium alloy	<4000ppm
	Copper alloy	<4wt%
4	Solder	<20ppm
	Parts composed of metals containing zinc (e.g. brass, zinc for die casting)	<100ppm
	Plastic	<5ppm
5	PBBs and PBDEs	Forbidden
6	PCB and PCT	Forbidden
7	CP, Short-chain Chlorinated paraffins C10-13, Cl ≥48 wt%	Forbidden
8	Mirex	Forbidden
9	PCN	Forbidden
10	Hexavalent Chromium compounds	<100ppm
11	Mercury and its compounds	Forbidden
12	Asbestos	Forbidden
13	Organic Tin compounds	Forbidden
14	Azo compounds	Forbidden
15	TBBP-A in external case plastic parts of products (PCB is exempted)	<1000ppm
16	Nickel in external case parts, which are likely to result in prolonged skin exposure	<1000ppm