

DC Fan

**172mm**

**San Ace 172**

25mm thick(Sidecut type)  
 51mm thick(Sidecut type SG type)  
 51mm thick(Sidecut type GV type)  
 51mm thick(Sidecut type)  
 51mm thick(Round type)



**General Specifications**

Material Frame: Aluminum, Impeller: Plastics (Flammability: UL94V-1)  
 Expected Life Refer to specifications L10:Survival rate:90% at 60 , rated voltage, and continuously run in a free air state  
 Lead Wire ⊕red ⊖black (Sensor) yellow (Control) brown  
 Storage Temperature 30 to 70 Non-condensing

**172mm 150mm 51mm** Mass 760g **SideCut type SG type**

**Specifications** The following nos. have PWM controls and pulse sensors.

Model No.	Rated Voltage V	Operating Voltage Range V	PWM duty cycle %		Rated Current A	Rated Input W	Rated Speed min <sup>-1</sup>	Max. Air Flow		Max. Static Pressure		SPL dB(A)	Operating Temperature	Expected Life h
			100	0				m <sup>3</sup> /min	CFM	Pa	inchH <sub>2</sub> O			
9SG5724P5H61	24	20.4 to 27.6	100	0	2.8	67.2	6,500	11.6	410	540	2.16	71	20 to 70	40,000
			0	0.18	4.32	1,300	2.32	81.9	30	0.12	28			
9SG5748P5G01	48	36 to 72	100	0	2.91	140	8,600	15.46	546	1,000	4.02	78	20 to 60	
			0	0.21	10.1	2,000	3.59	127	75.1	0.30	40			
9SG5748P5H01	48	36 to 72	100	0	1.62	78	6,500	11.60	410	770	3.09	71	20 to 60	
			0	0.21	10.1	2,000	3.59	127	75.1	0.30	40			

Available options: **Without Sensor** **Pulse Sensor**

PWM Frequency 25kHz

**Dimensions Unit : mm**

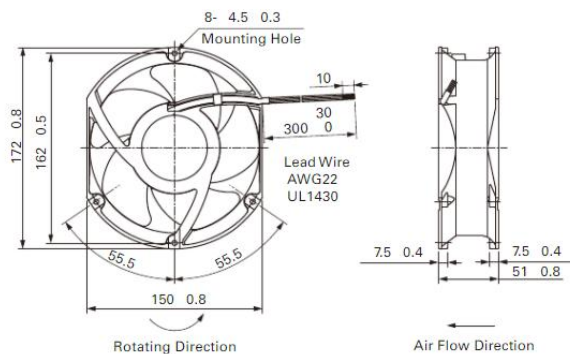

**Reference dimension of mounting holes and vent opening Unit : mm**

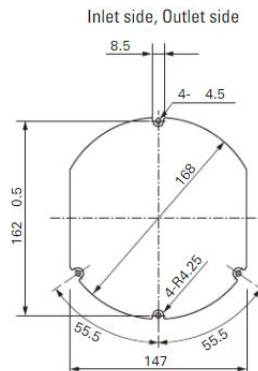

**Options Unit : mm**

**Finger guards**

Model 109-319J Surface treatment Nickel-chrome plating silver Color

For the finger guard Model: 109-319J, fix the finger guard to four holes as shown in the diagram.

Inlet side, Outlet side

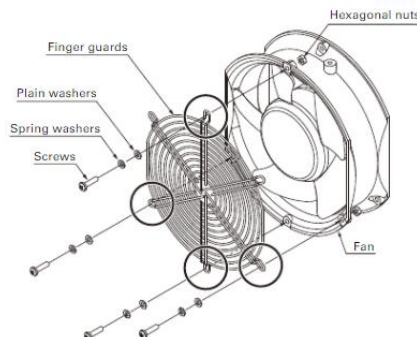
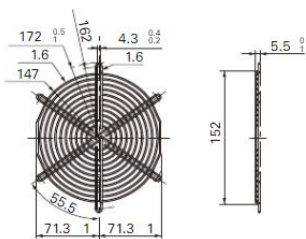

**Options Unit : mm**

**Finger guards**

Model 109-319E Surface treatment Nickel-chrome plating silver Color silver  
 Model 109-319H Surface treatment Cathion electropainting black Color black

Model 109-320 Surface treatment Nickel-chrome plating silver Color silver

For the finger guard Model: 109-319E, 109-319H, 109-320, fix the finger guard to two holes as shown in the diagram. Do not fix it to any other holes.

Inlet side, Outlet side

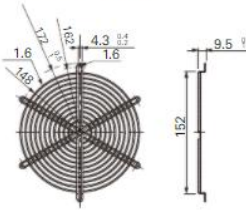

Outlet side

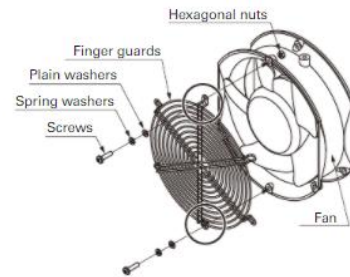
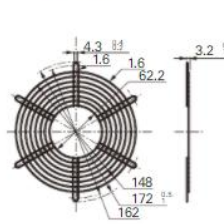

DC Fan 172mm

**Air Flow - Static Pressure Characteristics**

**PWM Duty Cycle**

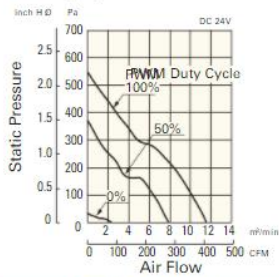

**9SG5724P5H61**

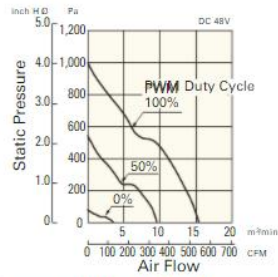

**9SG5748P5G01**

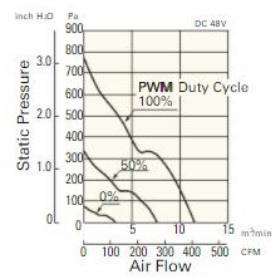

**9SG5748P5H01**

**Operating Voltage Range**

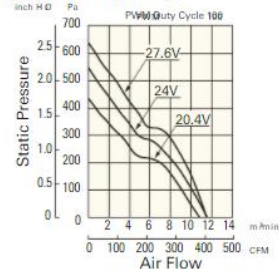

**9SG5724P5H61**

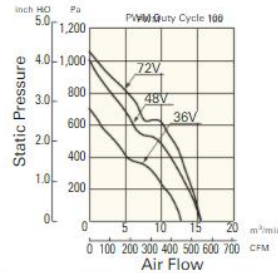

**9SG5748P5G01**

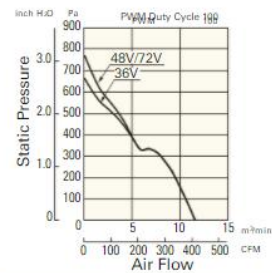

**9SG5748P5H01**

**PWM Duty - Speed Characteristics Example**

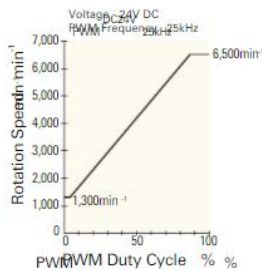

**9SG5724P5H61**

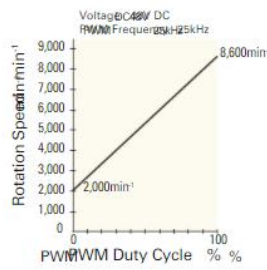

**9SG5748P5G01**

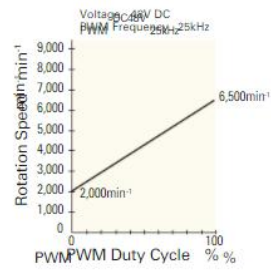

**9SG5748P5H01**