

TRP-C37M

User's Manual

勝特力材料 886-3-5753170
勝特力电子(上海) 86-21-34970699
勝特力电子(深圳) 86-755-83298787
[Http://www.100y.com.tw](http://www.100y.com.tw)

MODBUS TCP to RTU/ASCII Gateway



1. Introduction

The TRP-C37M which is able to analyzes the protocols between Modbus TCP and Modbus RTU / ASCII. It able to assign the UID of Modbus TCP slave from Modbus Serial Master.

The TRP-C37M which is suitable industrial environment Ethernet serial server, wide range power input and serial communicate protection, It Built-in surge, over current, over voltage ensure RS422 / 485 serial communication quality; if user lost password that can fast back to default by external switch.

The TRP-C37M can as serial server that support 3 operates mode, "Direct IP Mode", "Virtual COM Mode", and "Paired Mode", these modes are supported Modbus RTU / ASCII protocols.

The TRP-C37M offers maximum connection 16 host clients to link the one serial server, it is easy to operate in Modscan32 and Modbus Poll many application uses Virtual-COM mode and Pair Mode.

In network security, the TRP-C37M is able to set up 8 sets host IP, only these host IP can access the TRP-C37M.

The TRP-C37M provides a watchdog timer function, The Watchdog timer allows the system to automatically recover from a system crash. When the TRP-C37M MCU stop working correctly, the watchdog timer waits for a preset period of time, and performs a hardware reset .

When The TRP-C37M working at unstable voltage industrial environment, the power detection circuit can prevent the power fail cause of the boot fail then auto re-boot.

The TRP-C37M will be auto detects function which will be auto connect when the LAN disconnect then re-connect or power off then power on.

1-1 Features

- Wide input range DC power supply.
- Built-In watchdog function prevents system boot fail.
- Support Auto-MDIX twisted pair crossover detection and Auto-Correction.
- Modbus Type support TCP Master to Serial Slave and TCP Slave to Serial Master.
- Support 1 serial master to 8 TCP slave ,each TCP slave can free set up UID from 1~64.
- Compatible with Modscan32 ,Modbus Poll,CAS Modbus Scanner and SCADA .. Application.
- Support virtual com maximum connection 16 client.
- Maximum 8 sets host IP that limits network access.
- Surge protection and over current and over voltage on RS-422/485 data lines.
- Support baud rate from 1200~921600Kbps.
- Auto switching RS-232/422/485 signal interface.

勝特力材料 886-3-5753170
勝特力电子(上海) 86-21-34970699
勝特力电子(深圳) 86-755-83298787
[Http://www.100y.com.tw](http://www.100y.com.tw)

- Fully compatible with Ethernet and TCP/IP protocol.
- Supports 10/100 Mbps Ethernet.
- Power/Link/UART RX/UART TX mode LED indicator.
- Heart Beat function ensures a reliable communicating connection.
- Auto reconnection when power or Ethernet fail.
- Back to factory configuration by external switch.
- Support configuration by serial console.
- Update the firmware from LAN.
- Dual power input select from screw terminal or DC-Jack.

1-2 Specification

- Power Input Voltage: DC +10V to +30V.
- LAN: Auto-MDIX, 10/100 Mbps Auto-detecting.
- RS-232: TX, RX, RTS, CTS, DTR, DSR, DCD, GND.
- RS485 signal: differential 2 half-duplex wires (DATA+, DATA-).
- RS422 signal: differential 4 full-duplex wires.(TX+,RX+,TX-,RX-)
- Baud Rate: 1200,2400,4800,9600,19200,38400,57600,115200,921600 K bps.
- Parity: none, even, odd.
- Data Bits: 5, 6, 7 or 8.
- Stop Bits: 1, 1.5 or 2.
- Modbus TCP Type: TCP Master to Serial Slave, TCP Slave to Serial Master.
- TCP Slave to Serial Master Mode: Maximum 8 TCP Port. UID Range:1~64.
- Virtual COM drivers for Windows 98/WIN2000/WIN XP/Vista/WIN2003/WIN7/WIN8.
- Virtual-Com mode support RS232 TXD,RXD,GND/RS422 TX+,TX-,RX+,RX-/RS485 D+,D-.
- Power supply: Screw terminal, or DC jack.
- Serial interface: +/-15 KV ESD.
- RS422/485 interface: Surge, over current, over voltage protection.
- RS422/485 interface: Industrial plug-in screw terminal.
- Plug-in screw terminal wiring: Accepts AWG #12 ~30 wires.
- Power consumption: 12V/140mA.
- Operating Temperature: -10 to 65 °C.
- Humidity: 0~90% Non-Condensing.
- Dimensions: 151(L)*75(W)*26(H) mm.
- Weight: 395g with packing.

2. Hardware Description

The following information is provided to give the user an understanding of how to connect the TRP-C37M to the LAN and serial device. A review of the switch settings and the functionality of the LED's are also provided.

2-1. Panel layout

勝特力材料 886-3-5753170
勝特力电子(上海) 86-21-34970699
勝特力电子(深圳) 86-755-83298787
[Http://www.100y.com.tw](http://www.100y.com.tw)

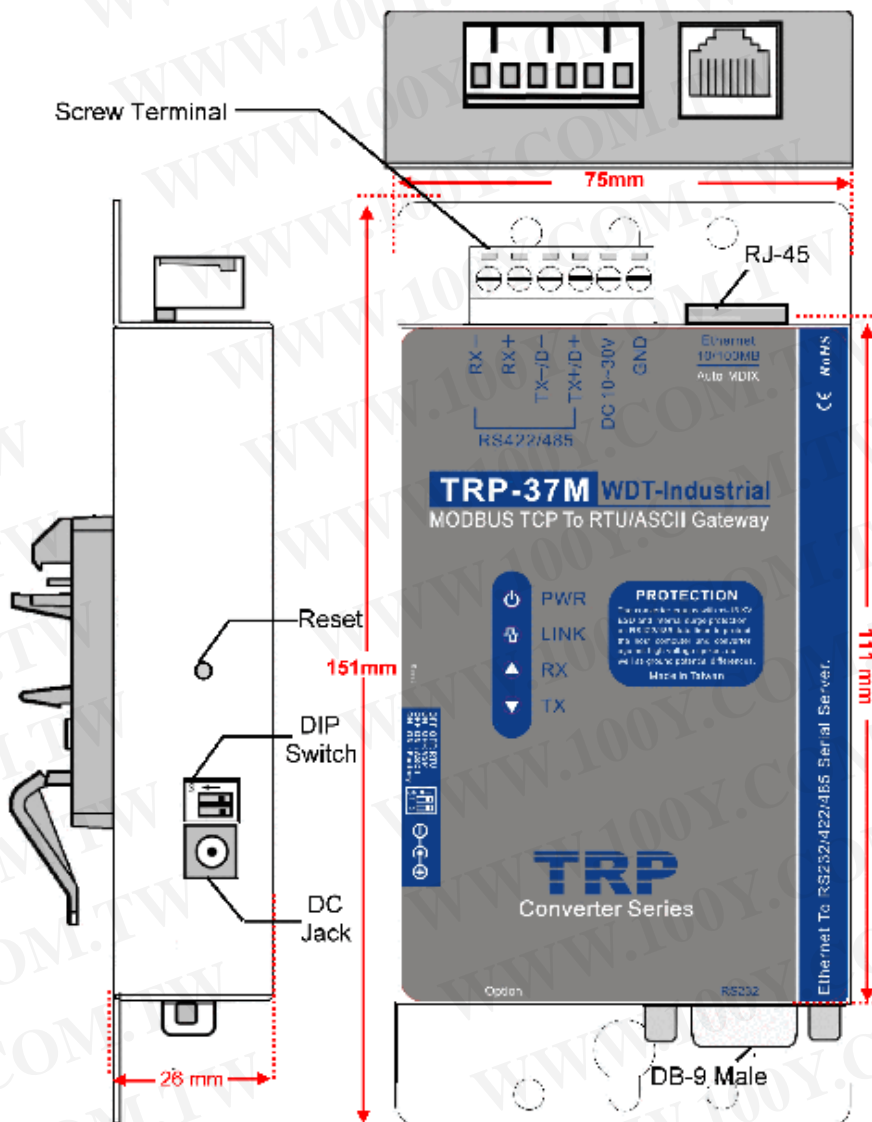

2-2. LED indicator

PWR LED: System is ready.(Blinking)

LINK LED: Ethernet cable connection and data active.

TX/RX LED: UART Transmitting/Receiving Indicator.

2-3. Power Input

DC Jack: Power Input DC +10V to +30V. (Please use the 5.5*2.1mm DC JACK).

There are two types power input.

a. Use the plug of power adaptor than plug in the DC jack on the side.

This approach also allows the user to provide additional power to other devices using the terminal from EU regulation.

b. Wiring terminals on the EU regulation

2-4. Reset Button

Push the reset button will Re-Boot.

2-5. DIP Switches

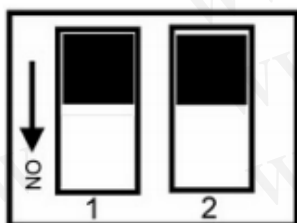

OFF	OFF	: Modbus RTU/Direct IP
ON	OFF	: Paired Mode/Virtual COM
OFF	ON	: Modbus ASCII
ON	ON	: Back to Factory

2-6. How to back factory by external DIP Switches 1,2

Power off then adjusts the SW 1, 2 to ON ON position then power on until the PWR LED blinking.

Adjusts the SW 1,2 to OFF,OFF.

2-7. Factory Setting

Device Setup [X]

Network Setting | Serial Port Setting

Device Name: TRP-C37M Module Name: TRP-C37M

MAC Address: 00-0E-C6-00-02-04 Netmask: 255.255.255.0

DHCP: Enable

Server/Master
Listening IP: 192.168.1.1 Gateway: 192.168.1.3

Data listening port: 502 DNS Server: 168.95.1.1

Client/Slave
Transmit Timer (ms): 10

UID Range	Client/Slave IP Address	Port
1 To 8	0.0.0.0	502
9 To 16	0.0.0.0	502
17 To 24	0.0.0.0	502
25 To 32	0.0.0.0	502
33 To 40	0.0.0.0	502
41 To 48	0.0.0.0	502
49 To 56	0.0.0.0	502
57 To 64	0.0.0.0	502

Heart Beat: Disable

Maximun Connection: 1

TCP Keep Alive Timer: 7

New Password:

Firmware Version: 352

Data Packet Type:
 UDP
 Auto connect after reboot
 TCP

Management Packet Type:
 Broadcast
 Multicast

Submit Save Load

Network Setting | Serial Port Setting

Baud rate: 9600

Data bits: 8

Parity: None

Stop bits: 1

Flow Control: None

2-6. DB-9 Pin male pin assignment

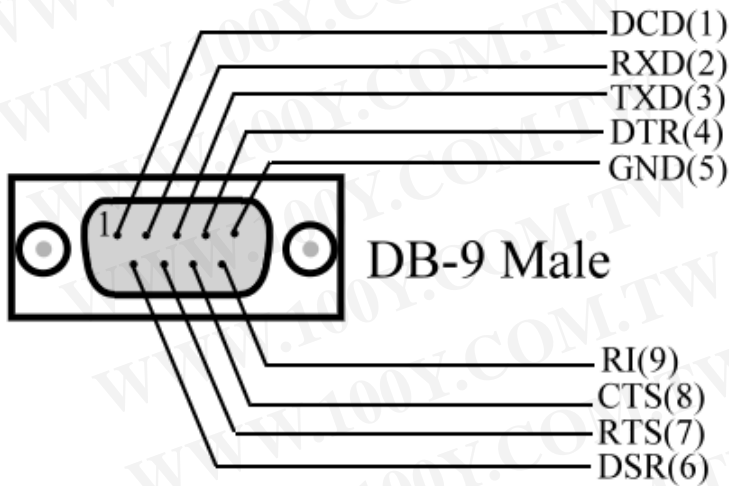

3. Install TRP-C37M Hardware

STEP1: Connect power source with TRP-C37M, the PWR LED will blinking.

STEP2: Connect TRP-C37M with internet port by RJ45 LAN cable.

If the cable is properly connected the “LINK” LED will light up.

**The TRP-C37M Support Auto-MDIX, A straight-through or crossover Ethernet cable can be used to make a connection directly to the HUB/Router/PC.*

STEP3: Connect TRP-C37M with RS232 or RS422/485 RTU/ASCII of serial device.

The TRP-C37M has one DB-9 male connectors for RS232 connection and a screw terminal connector for RS422/485 connection.

The DB-9 serial port is DTE interface. A null modem cable is required to make a connection between the COM port on a PC and the TRP-C37M serial port. A straight through cable is required to connect the TRP-C37M serial port to a DCE device.

The screw terminal connector accepts AWG #12 ~30 wires.

3-1. RS485 Wiring

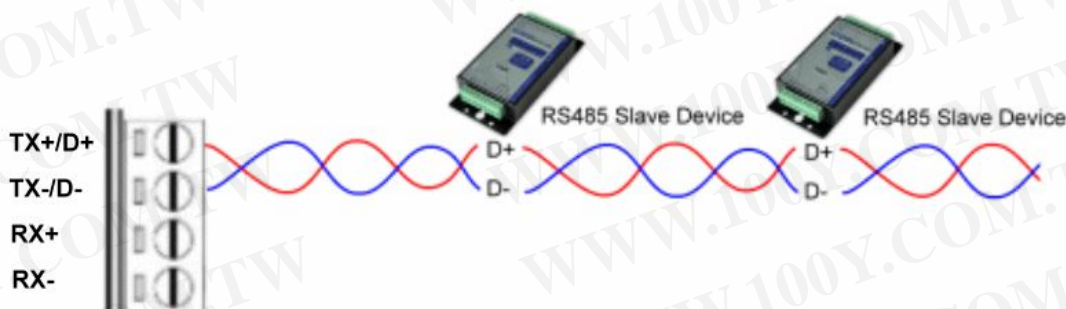

3-2. RS422 Wiring

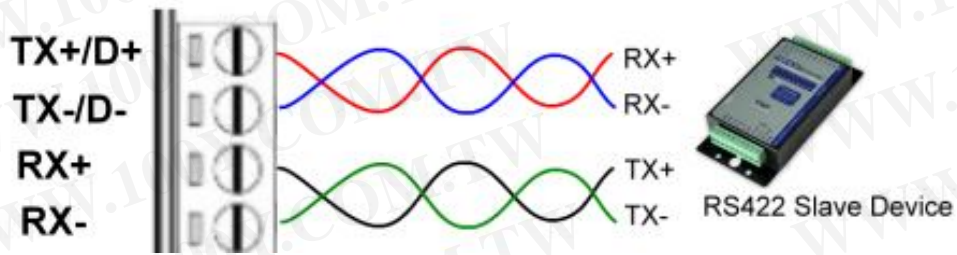

3-3. RS232 Wiring

The RS-232 supports 8 channels plus Signal Ground and is configured as DTE like a computer. Signals are single ended and referenced to Ground. To use handshaking, Flow Control must be set to RTS/CTS during Configuration. Refer to the Pin out table for connections.

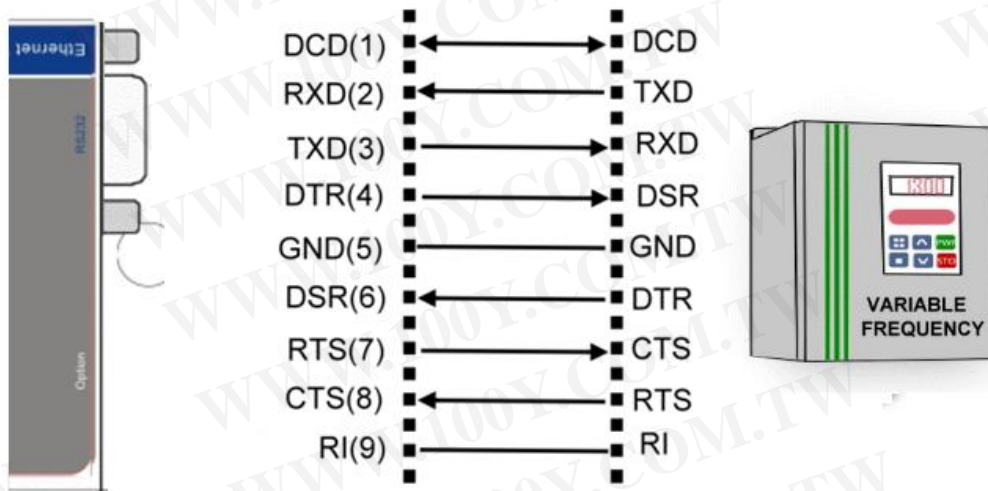

4. How to configure TRP-C37M

There are 3 ways to access the Server Properties and program the TRP-C37M.

a. TRP-C37X DSM utility.

TRYCOM DSM 6.02

TRYCOM **TRP-Ethernet Series DSM**
TRP-C09/C37/C37M/C24H/C26H/C28H/C29H/C68H
IPC

DSM Setting
Setting

DSM Function
Search
IP Search
Device Setup
Web Browser
Restore
Reboot
Upgrade

Device Status List

NO.	Device Name	MAC Address	DHCP	IP	Port	Mode	Status
<input checked="" type="checkbox"/>	1	TRP-C37M	00-0E-C6-00-02-5A	Disable	192.168.0.123	502	Master Idle

Device Setup

Network Setting | Serial Port | Modbus Setting

Device Name: TRP-C37M Module Name: TRP-C37M

MAC Address: 00-0E-C6-00-02-5A Netmask: 255.255.255.0

DHCP: Disable Gateway: 192.168.1.3

Server/Master DNS: 168.95.1.1

Listening IP: 192.168.0.123 Transmit Time/Plus: 3

Data listening port: 502 Heart Beat: Disable

Client/Slave Maximum Connection: 16

UID Range	Client/Slave IP Address	Port	TCP Keep Alive
0 To 0	0.0.0.0	502	7
0 To 0	0.0.0.0	502	
0 To 0	0.0.0.0	0	
0 To 0	0.0.0.0	0	
0 To 0	0.0.0.0	0	
0 To 0	0.0.0.0	0	
0 To 0	0.0.0.0	0	
0 To 0	0.0.0.0	0	

New Password: ***** (0-65535) Firmware Version: 601

Data Packet Type: UDP Auto connect after reboot TCP

Management Packet Type: Broadcast Multicast

Submit Save Load

b. WEB Server



TRP-C37M

WDT-inside

Ethernet to RS232/422/485 Serial Server

Serial Settings

Data Baud Rate	9600 ▼
Data Bits	8 ▼
Data Parity	None ▼
Stop Bits	1 ▼
Flow Control	None ▼

Network Settings

<input type="checkbox"/> Enable DHCP	
Static IP Address	192.168.0.123
Static Subnet Mask	255.255.255.0
Static Default Gateway	192.168.1.3
Static DNS Server	168.95.1.1
Connection Type	TCP ▼
Transmit Timer	3
Maximum Connection	16

Master/Slave

Master Listening Port	502
Slave IP Address	0.0.0.0
Slave Port	502

New Password

..... (0~65535)
 Enable Reboot
Apply Reset

c. Serial Console

```

D:\C37M_0~2\C-37M~1.EXE
Trycom Technology Co.,Ltd
TRP-C37M Console Ver 1.01

Firmware Uerson : 1706

Device Name      : TRP-C37M      Netmask          : 255.255.255.0
MAC Address      : 00-0E-C6-00-01-E3  Gateway          : 192.168.1.3
DHCP             : Enable        DNS              : 168.95.1.1
Master/Server   : Enable        Transmit Timer   : 10
Listening IP     : 192.168.1.1    Heart Beat       : Disable
Listening Port   : 502          Maximum Connection: 1
Slave/Client     : Disable       TCP Keep Alive   : 7
Destination IP   : 0.0.0.0        New Password     : XXXX
Destination Port : 502          Serial Port Setting
UDP             : Disable       Baud Rate        : 9600
Auto Connect    : Disable       Data Bits        : 8
TCP             : Enable        Parity           : NONE
Broadcast       : Enable        Stop Bits        : 1
Multicast       : Disable       Flow Control     : NONE

Note :
(↑↓) Move, (←) Select, + Back, F2 Save, F3 Slave Setting, (ESC) For Exit

```

```

D:\C37M_0~2\C-37M~1.EXE
Trycom Technology Co.,Ltd
TRP-C37M Console Ver 1.01

Firmware Uerson : 1706

UID Range      Slave IP Address  Port
1  1 To 8       0.0.0.0          502
2  9 To 16     0.0.0.0          502
3  17 To 24    0.0.0.0          502
4  25 To 32    0.0.0.0          502
5  33 To 40    0.0.0.0          502
6  41 To 48    0.0.0.0          502
7  49 To 56    0.0.0.0          502
8  57 To 64    0.0.0.0          502

Note :
(↑↓) Move, (←) Select, + Back, (ESC) For Main Setting, (ESC) For Exit

```

4-1. Using TRP-C37X DSM Utility.

The “TRP-C37X DSM” software performs several functions:

- A: Searching for TRP-C37M connected to the network.
- B: Displaying and changing the configuration of TRP-C37M.
- C: Upgrading the TRP-C37M firmware.

*Refer the Firmware upgrade help file.

D: Saving and Loading Configuration from external log File or EEPROM.

4-2. Searching LAN for TRP-C37M

Once TRP-C37M is connected to the LAN the **TRP-C37X DSM** software will search it and display it in a window by name , IP address, Mac....Information.

The screenshot shows the 'TRYCOM DSM 6.02' application window. The title bar reads 'TRYCOM DSM 6.02'. The main window features the 'TRYCOM IPC' logo and the title 'TRP-Ethernet Series DSM' with a subtitle 'TRP-C09/C37/C37M/C24H/C26H/C28H/C29H/C68H'. On the left side, there are two vertical panels: 'DSM Setting' with a 'Setting' button, and 'DSM Function' with buttons for 'Search', 'IP Search', 'Device Setup', 'Web Browser', 'Restore', 'Reboot', and 'Upgrade'. The central area is titled 'Device Status List' and contains a table with the following data:

NO.	Device Name	MAC Address	DHCP	IP	Port	Mode	Status	
<input checked="" type="checkbox"/>	1	TRP-C37M	00-0E-C6-00-02-5A	Disable	192.168.0.123	502	Master	Idle

At the bottom right of the window, there are two status indicators: 'DSM Status: Idle' and 'Progress:'.

4-3. Configuring Server Properties

Select the "NO." item and Double click to open the Server configuration, after setting then click "Submit" will save the configuration to EEPROM.

The screenshot shows the 'Device Setup' window with two tabs: 'Network Setting' and 'Serial Port_Modbus Setting'. The 'Network Setting' tab is active, displaying various configuration fields. The 'Serial Port_Modbus Setting' tab is also visible, showing a table for mapping UID ranges to IP addresses and ports.

Network Setting:

- Device Name: TRP-C37M
- Module Name: TRP-C37M
- MAC Address: 00-0E-C6-00-02-5A
- Netmask: 255.255.255.0
- DHCP: Disable
- Gateway: 192.168.1.3
- Server/Master Listening IP: 192.168.0.123
- DNS: 168.95.1.1
- Data listening port: 502
- Transmit Time/Plus: 3
- Heart Beat: Disable
- Maximum Connection: 16
- TCP Keep Alive: 7
- New Password: ***** (0~65535)
- Firmware Version: 601

Serial Port_Modbus Setting:

UID Range		Client/Slave IP Address	Port
0	To 0	0.0.0.0	502
0	To 0	0.0.0.0	502
0	To 0	0.0.0.0	0
0	To 0	0.0.0.0	0
0	To 0	0.0.0.0	0
0	To 0	0.0.0.0	0
0	To 0	0.0.0.0	0
0	To 0	0.0.0.0	0

Data Packet Type:

- UDP
- Auto connect after reboot
- TCP

Management Packet Type:

- Broadcast
- Multicast

Buttons at the bottom: Submit, Save, Load.

Device Name

Device server name, Maximum 10 chars.

MAC Address

The Device server MAC address.

DHCP

If DHCP is disabled, it allows user setting the IP address, Subnet mask, Gateway.

If DHCP is enabled ,the IP address, Subnet mask, Gateway address will be dynamically configuration by DHCP server such router.

When “DHCP” is enabled ,but the DHCP server is not available on the network, the TRP-C37M will timeout then back to factory setting IP=192.168.1.1.

Master mode:

Listening IP: The Gateway IP address.

Listening port:RS232/422/485 port address.

Slave Mode:

UID Range(1~64) Using UID range to map a query from Modbus serial master with an UID within this range to an IP and port.

Slave IP Address and TCP port

The TRP-C37M maps a message from MODBUS serial master to a serial slave.

Netmask

The default LAN Netmask is configured for a Class C address. This may be reconfigured by the user.

Gateway

Input the gateway IP address that can be allows users to access the serial gateway from internet.

DNS

Short for Domain Name System, an Internet service that translates domain names into IP addresses. Because domain names are alphabetic, they're easier to remember. The Internet however, is really based on IP addresses. Every time you use a domain name, therefore, a DNS service must translate the name into the corresponding IP address.

Transmit timer:0~500 mS/Unit

Time interval to send out serial data char starting packet.

****The function main support serial data input to TRP-C37M RS232/422/485 port, if serial data is a mass of serial data over 1K Byte ,Trying to adjust the Timer to 200ms.***

Hear Beat: Disable /Enable

When Hear Beat enable, it allows open a 5300 port, 5 sec interval to send out data char packet that provides a easy way to ensure the LAN communications between Host PC Client and gateway devices.

Maximum Connection: 1~16

The function allows the user to configure the TRP-C37M Serial Gateway to have up to 16 TCP client connections.

TCP Keep Alive: 1~7 /Minute

When TRP-C37M in Server mode, the TRP-C37M without data over the 1~7 Min setting value, The TRP-C37M will be disconnecting TCP.

When TRP-C37M in Client mode, the TRP-C37M without data over the 1~7 Min setting value, The TRP-C37M will be reconnecting TCP.

New Password: 12345

It only accepts value from 0~65535 integer, if input the wrong password over 5 times, the WEB-Page will lock until the TRP-C37M re-boot.

Firmware Version

Firmware Version.

Serial Port setting

Baud Rate: UART Speed from 1200,2400,4800,9600,19200,38400,57600,115200,921600 k bps

Data Bit: 5,6,7,8

Parity: Odd, Even, None

Stop Bits: 1, 1.5,2

Flow Control: Xon/Xoff, Hardware, None

Submit

Save the setting value to EEPROM.

Save

Save the setting value to external log file.

Load

Load the setting value to external log file.

Upgrade

Upgrade the firmware

4-4 using the WEB Server mode

The Web Server can be used to configure the TRP-C37M Serial Gateway from any web browser software (such as I.E).

In Internet Explorer type the IP Address of the Serial Gateway into the address field and press the **Enter** key. The following window will appear:

Example:

If TRP-C37M IP is 192.168.1.1 Please Input the 192.168.1.1 then enters at web address, the web-page will appear..... See diagram below.

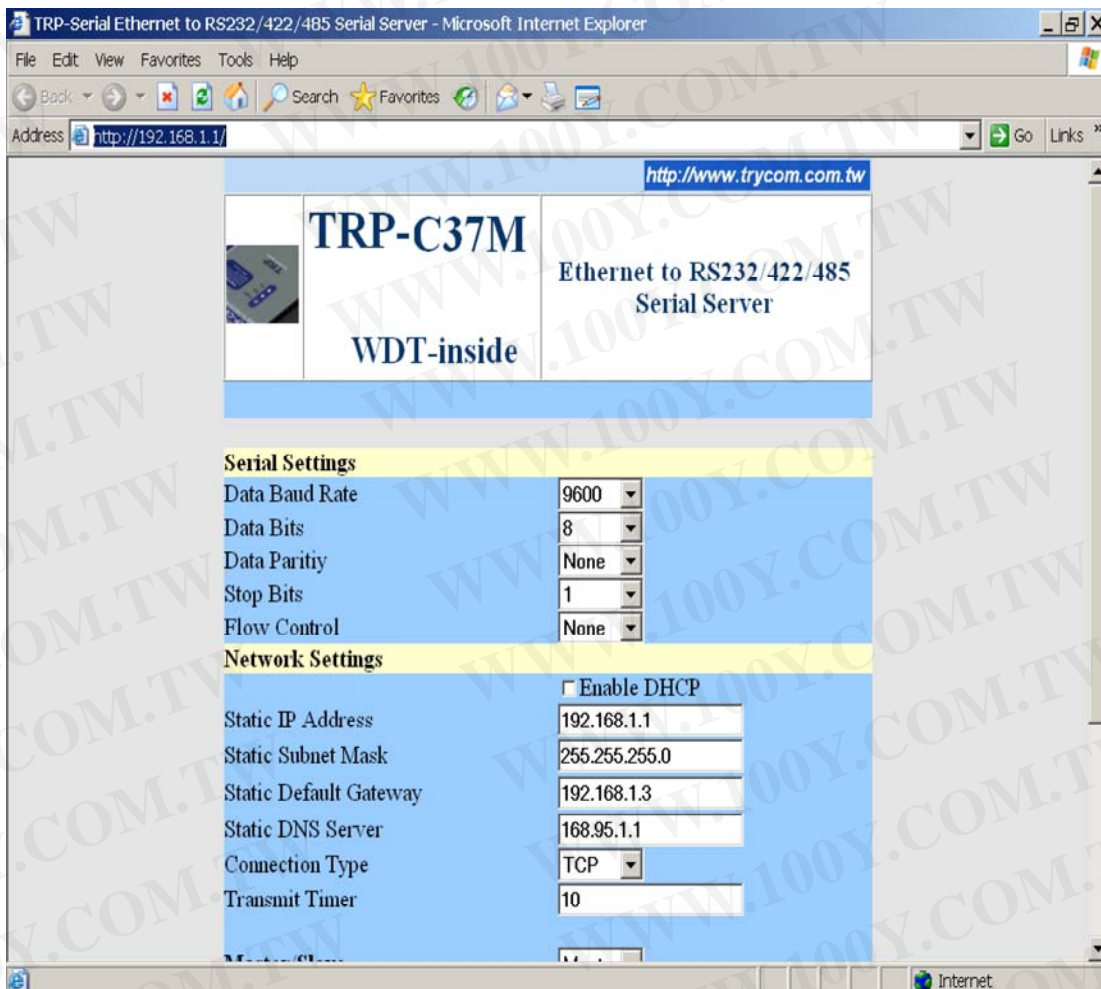

4-5 using the serial console mode

The serial console can be used to configure the TRP-C37M Serial Server from DB-9 connector link the HOST PC by null modem cable.

COM PORT



Host PC

Null-MODEM CABLE

PIN2----PIN3
 PIN3----PIN2
 PIN5----PIN5

RS232 Port



Insert the TRP-Serial CD then find the CONSOLE.exe, The CONSOLE file support all windows O.S include MS-DOS, Run the CONSOLE file and **Re-boot** the TRP-C37M then select correct host COM port number and data format.

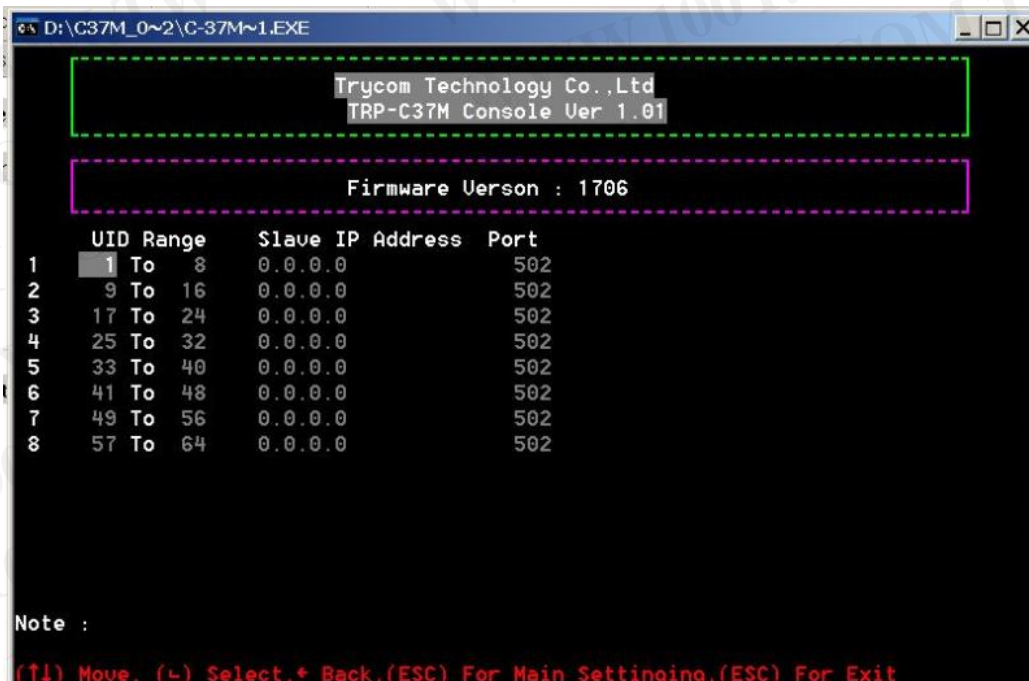
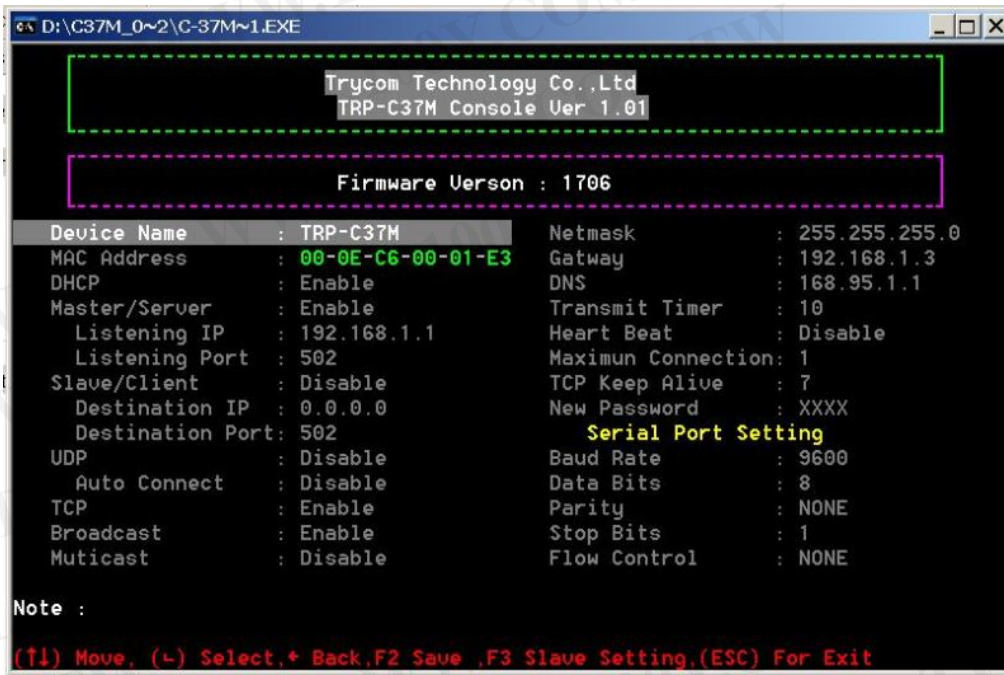

4-6 How to setup the network security

In network security, the TRP-C37M is able to setup 1~ 8 sets host IP, only these host IP can access the TRP-C37M.

The TRP-C37M actually can make connections with any Host IP,

Once the user has filled in the Host IP, these IP are valid, the TRP-C37M will be pass with them.

Other host IP will not pass.

Refer to the following example illustrates.

*Please make sure the firmware version is 601 above,

and the DSM utility version 6.02 above.

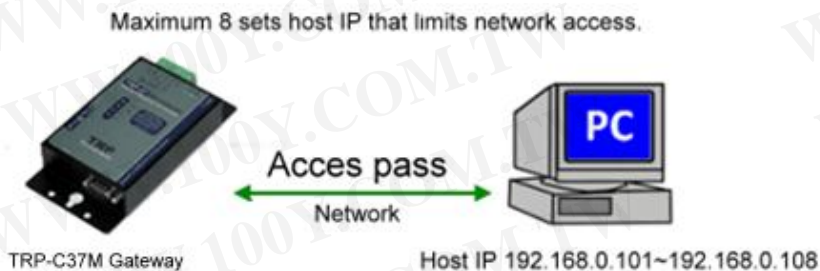

Device Setup

Network Setting | Serial Port | Modbus Setting

Device Name	TRP-C37M	Module Name	TRP-C37M
MAC Address	00-DE-C6-00-02-5A	Netmask	255.255.255.0
DHCP	Disable	Gateway	192.168.1.3
<input checked="" type="radio"/> Server/Master		DNS	168.95.1.1
Listening IP	192.168.0.123	Transmit Time/Plus	3
Data listening port	502	Heart Beat	Disable
<input type="radio"/> Client/Slave		Maximum Connection	16
UID Range		TCP Keep Alive	7
Client/Slave IP Address	Port	New Password	***** (0-65535)
<input type="checkbox"/> To <input type="checkbox"/>	<input type="checkbox"/> 192.168.0.101	<input type="checkbox"/> 502	
<input type="checkbox"/> To <input type="checkbox"/>	<input type="checkbox"/> 192.168.0.102	<input type="checkbox"/> 502	
<input type="checkbox"/> To <input type="checkbox"/>	<input type="checkbox"/> 192.168.0.103	<input type="checkbox"/> 0	
<input type="checkbox"/> To <input type="checkbox"/>	<input type="checkbox"/> 192.168.0.104	<input type="checkbox"/> 0	
<input type="checkbox"/> To <input type="checkbox"/>	<input type="checkbox"/> 192.168.0.105	<input type="checkbox"/> 0	
<input type="checkbox"/> To <input type="checkbox"/>	<input type="checkbox"/> 192.168.0.106	<input type="checkbox"/> 0	
<input type="checkbox"/> To <input type="checkbox"/>	<input type="checkbox"/> 192.168.0.107	<input type="checkbox"/> 0	
<input type="checkbox"/> To <input type="checkbox"/>	<input type="checkbox"/> 192.168.0.108	<input type="checkbox"/> 0	

Firmware Version: 601

Data Packet Type: UDP, Auto connect after reboot, TCP

Management Packet Type: Broadcast, Multicast

Buttons: Submit, Save, Load

5. Install the Virtual-COM

The Virtual-COM utility support TCP/IP 、 UDP data mapping to the HOST PC virtual-com, it can creative Maximum 512~1024 virtual-com port, Support Server 、 Client 、 UDP mode, Support all Windows O.S include Win98/Win2000/WinXP/Vista/Win2003/WIN7,Support Multi-virtual com at different PC to one Serial Gateway; Support Ethernet and Internet , If TRP-C37M off line or power fail, The Virtual-Com utility will try to Reconnection.

Step 1. Adjust the switch position to “ON, OFF”.

Step 2. Insert the TRP-Serial CD and find the TRP-C37M folder.

Step 3. Click “Vcomm.exe” icon then install Virtual-COM utility.

*The Virtual COM utility support multi-language, please select which language do you need.

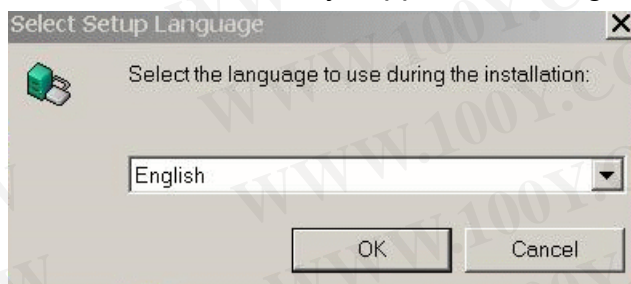

Step4. Click “OK” button and select “VSP run as Client support Server Device”.

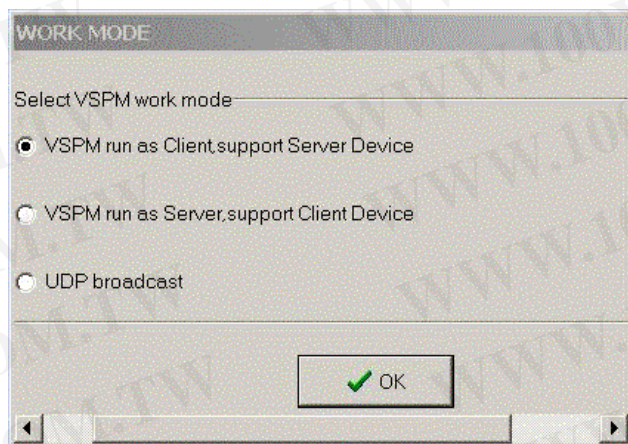

Step5. Select “Create virtual serial by device scanner”, then press “OK”

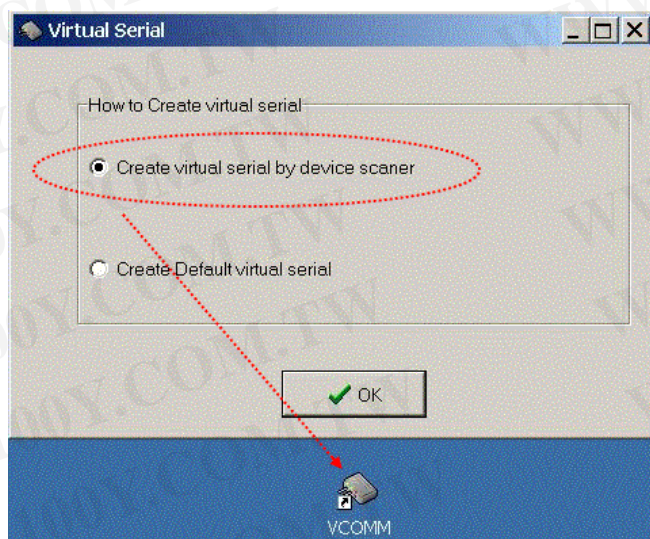

Step6. Run VCOMM.exe then click right button select “New Virtual COM”

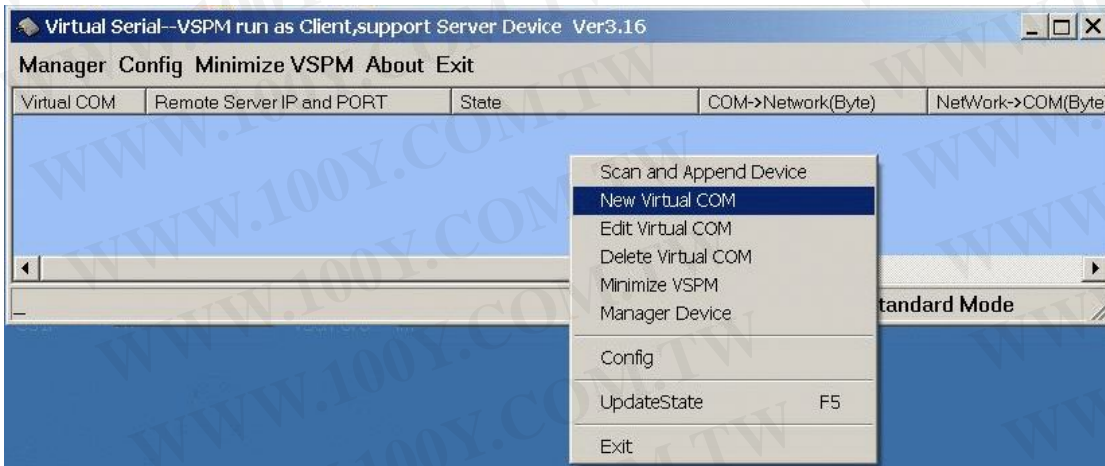

Step7. Select “Select Serial Port” and input TRP-C37M IP and port then press “OK”.

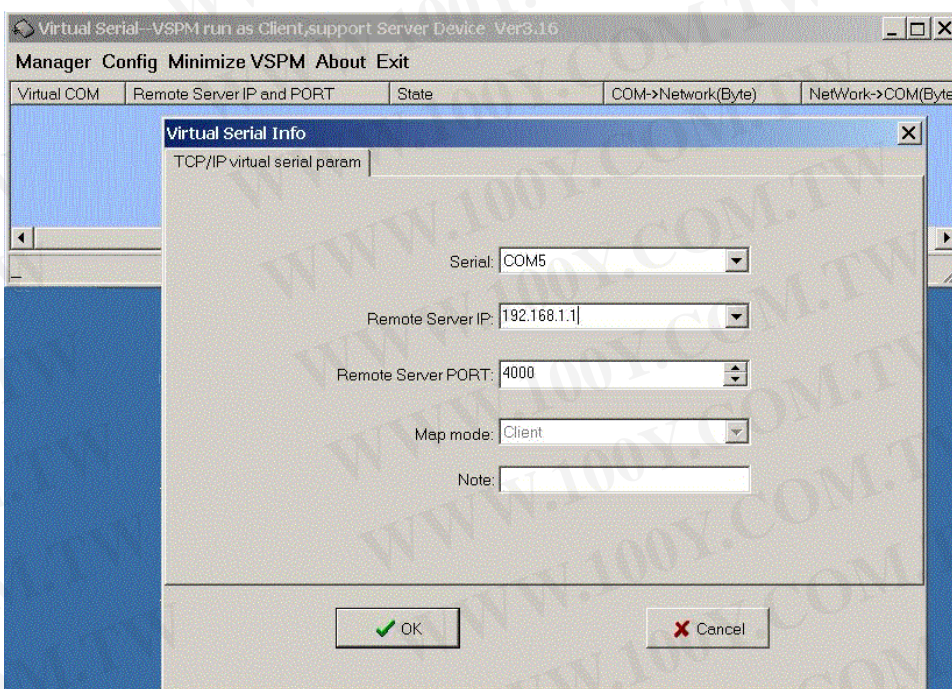

Step8. If Virtual-Com setting success, the display will appear bellow.

Step9. Run TRPCOM utility then select virtual-com port make a TRP-C37M loop test.

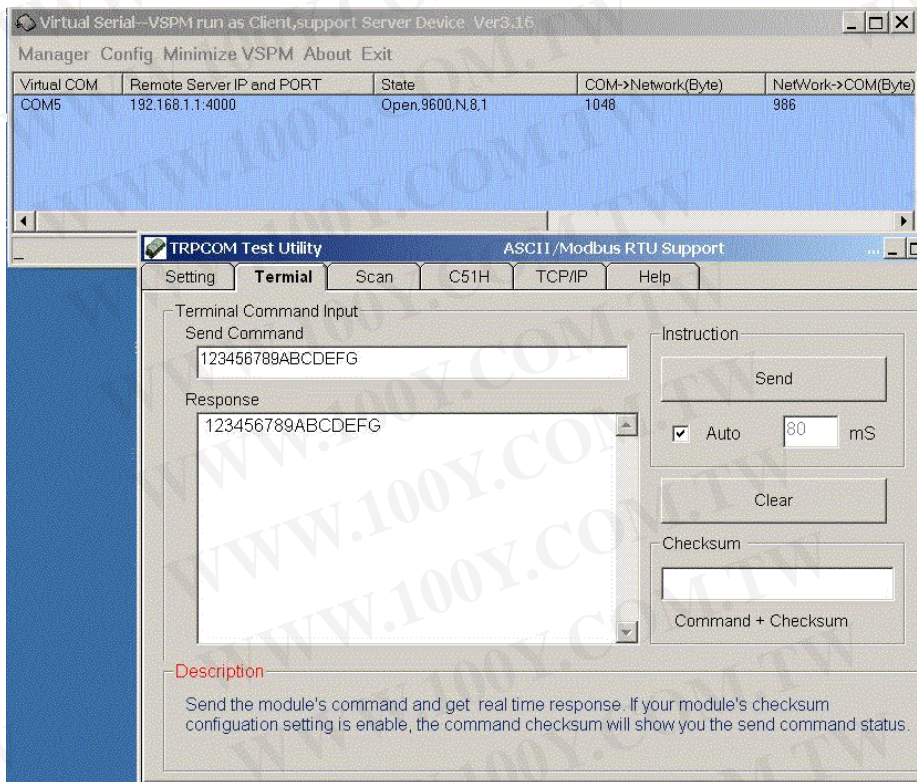

*If in VCOMM's configuration select "Boot with windows", the virtual-com will Auto-connection when windows start.

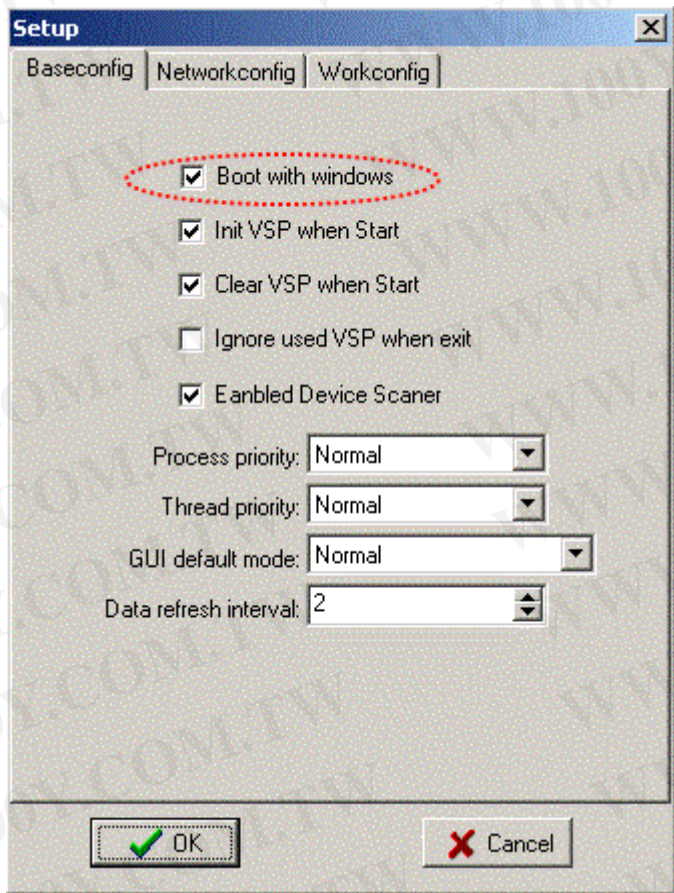

6. Application

6-1 Modbus TCP Master to Modbus RTU/ASCII Serial Slave Mode

**Notice: If TRP-C37M is MODBUS RTU protocol, Please turn the switch 1,2 to OFF,OFF.*

OR if TRP-C37M device is MODBUS ASCII, Please turn the switch1,2 to OFF,ON.



Example:

Step1: Connect PC-----Ethernet-----TRP-C37M-----RS232/422/485---MODBUS RTU/ASCII device.

Step2.Run Modscan32 utility and input IP/Port, click "OK" button, then Select function code, the response will appear below.

**The Modscan32 utility copyright belong the Win-TECH Software Design, user can find it from the www.win-tech.com.*

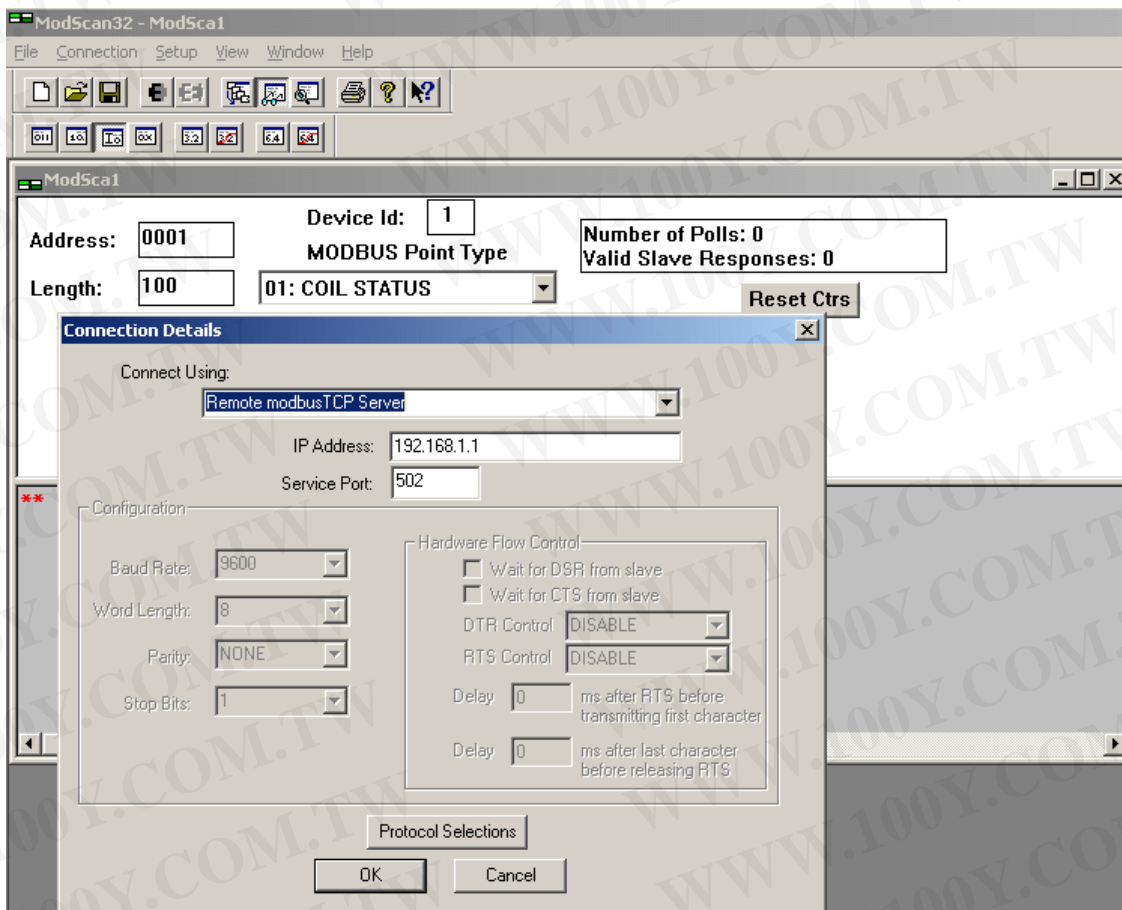

Step3.Select function code.

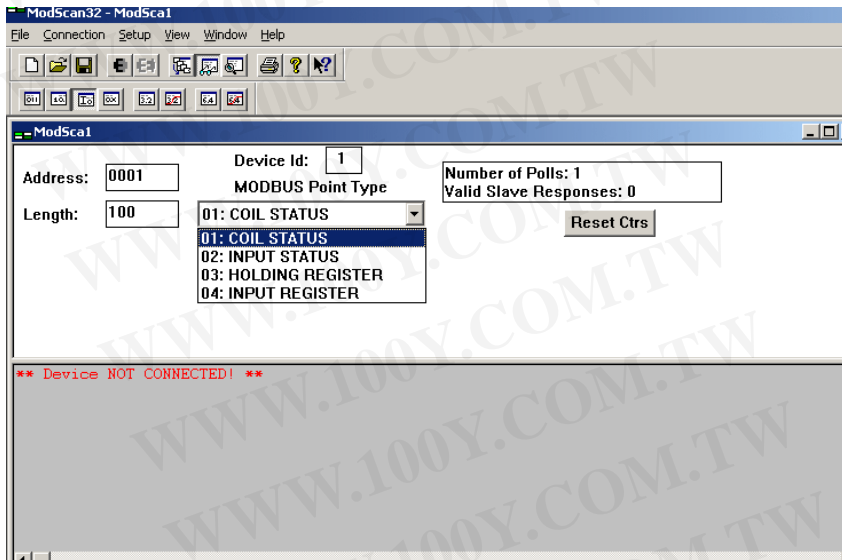

Step4.the modscan32 will be response below.

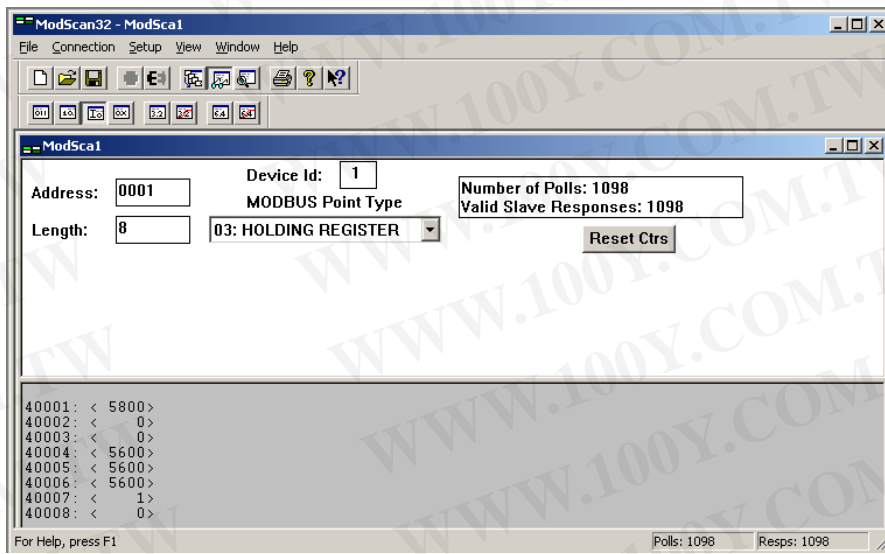

6-2 Modbus TCP Slave to Serial Master

***Notice: If TRP-C37M is MODBUS RTU protocol, Please turn the switch 1,2 to OFF,OFF.
OR if TRP-C37M device is MODBUS ASCII, Please turn the switch1,2 to OFF,ON.**



Example:

Step1: Connect Serial Master PC-----RS232-----TRP-C37M-----Ethernet---Multi TCP Slave PC.

Step2: Run DSM Search the TRP-C37M and change the setting.

The screenshot shows the 'Device Setup' window with two tabs: 'Network Setting' and 'Serial Port Setting'. The 'Serial Port Setting' tab is active. The device name is 'TRP-C37M'. The MAC address is '00-0E-C6-00-02-04'. The DHCP is set to 'Enable'. The listening IP is '192.168.1.1' and the data listening port is '502'. The device is configured as a 'Client/Slave'. A table lists client/slave configurations with a red circle around the first row (UID 1 to 8, IP 192.168.1.8, port 502). Other settings include Netmask (255.255.255.0), Gateway (192.168.1.3), DNS Server (168.95.1.1), Transmit Timer (10 ms), Heart Beat (Disable), Maximum Connection (1), TCP Keep Alive Timer (7), New Password (blank), and Firmware Version (352). Packet type options are checked for TCP and Broadcast.

UID Range	Client/Slave IP Address	Port
1 To 8	192.168.1.8	502
9 To 16	0.0.0.0	502
17 To 24	0.0.0.0	502
25 To 32	0.0.0.0	502
33 To 40	0.0.0.0	502
41 To 48	0.0.0.0	502
49 To 56	0.0.0.0	502
57 To 64	0.0.0.0	502

Step3: Run Modbus Poll utility from serial master PC.

***The Modbus Poll and Modbus Slave utility copyright belong the Witte Communications Company Design; user can find it from the www.modbustools.com.**

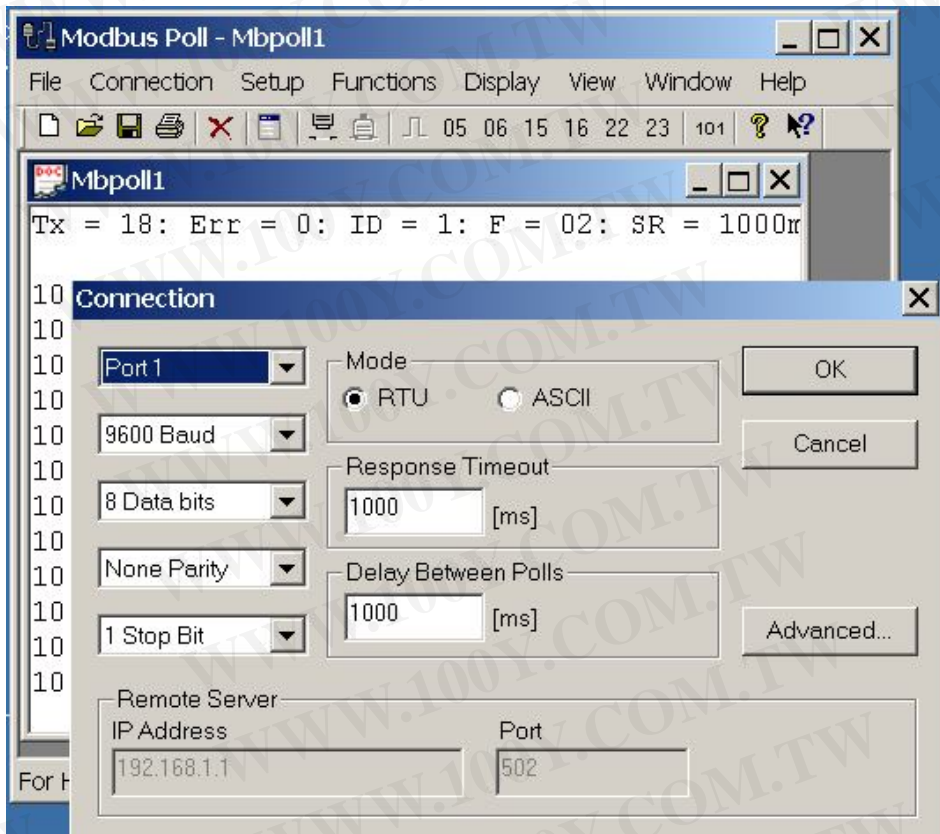

Step4: Run Modbus Slave utility from TCP Slave PC and setting the function code as same as the Modbus poll.

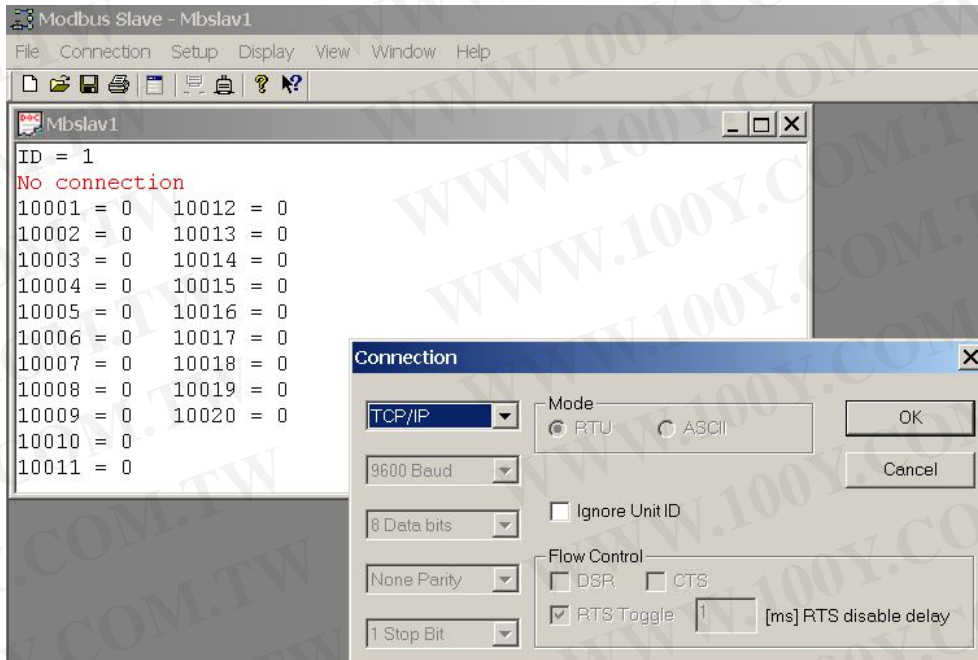

6-3 Virtual COM Mode *Bridge Mode

*Notice: Please turn the switch 1,2 to ON,OFF for Virtual-COM Mode.

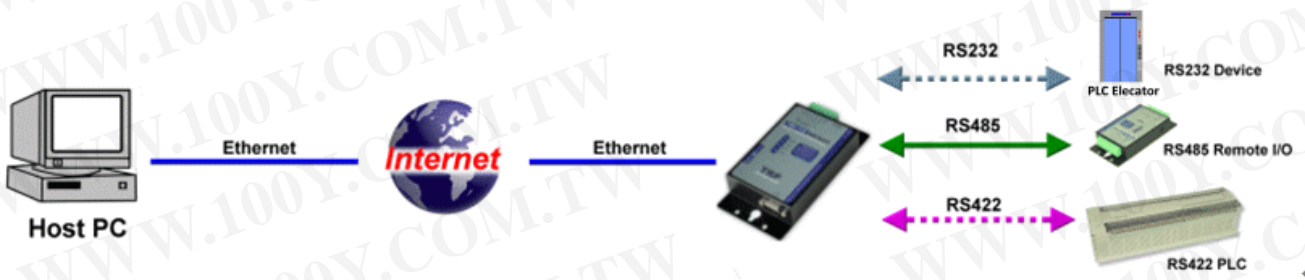

Example:

Step1. Connect PC-----Ethernet-----TRP-C37M-----RS232/422/485---MODBUS RTU/ASCII device.

Step2. Run Virtual-COM utility and make a virtual-COM port, Run modscan32 utility and input com port number, press “OK”.

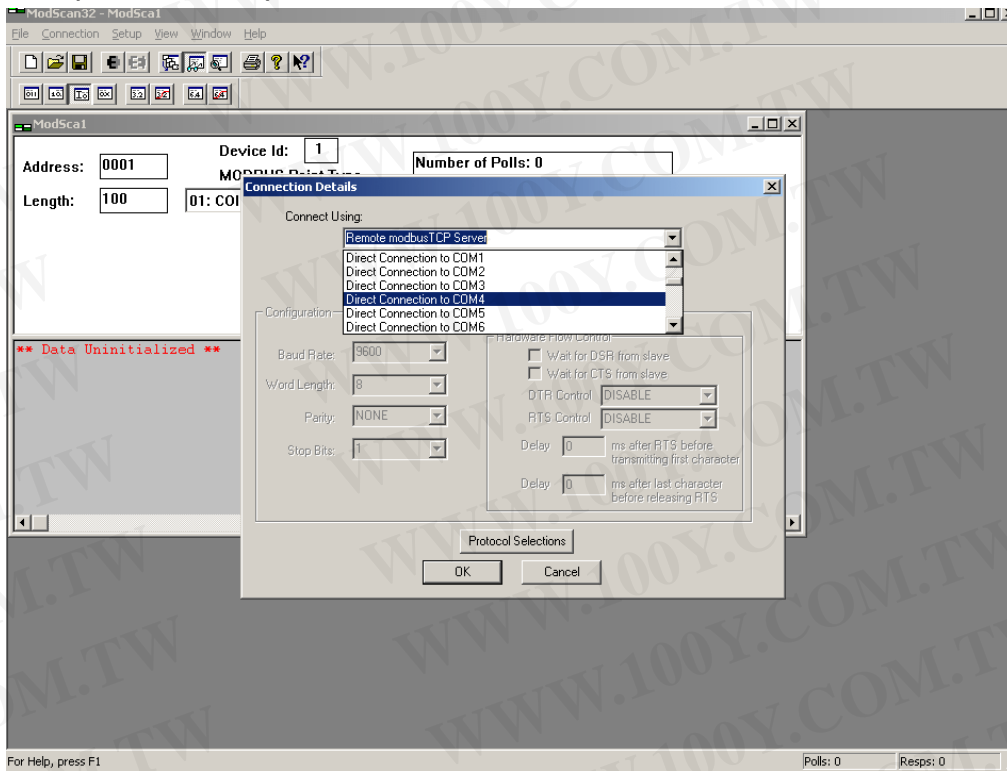

Step3. Select function code which you need.

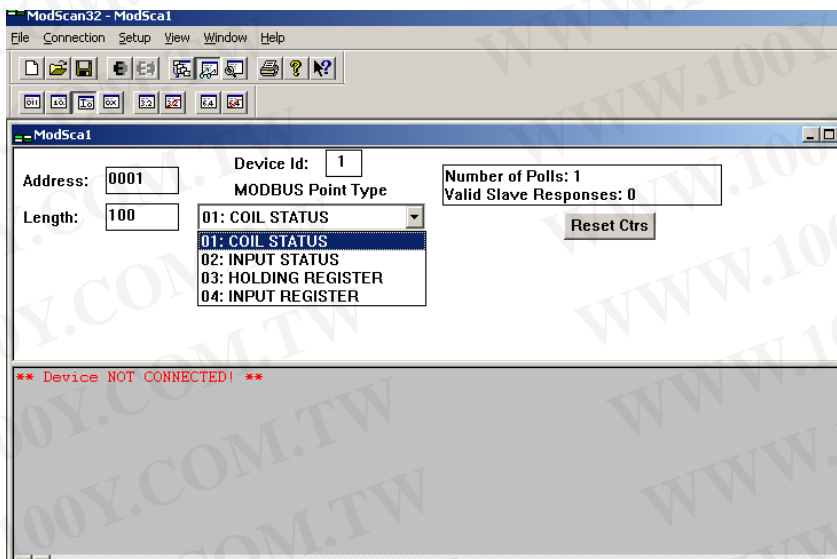

Step4.the modscan32 will be response below.

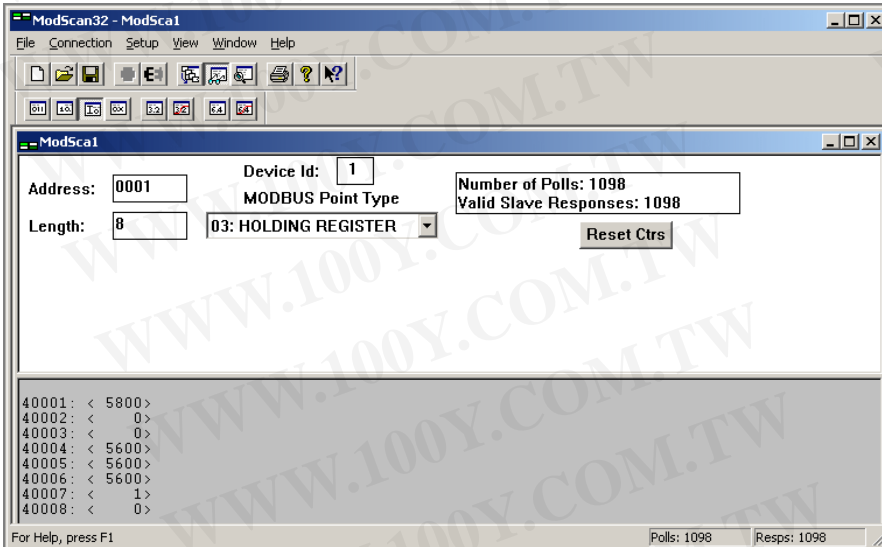

6-4 Paired Mode *Bridge Mode

*Notice: Please turn the switch 1,2 to ON,OFF for Paired Mode.



Example:

Step1. Connect PC---RS232/422/485---TRP-C37M----Ethernet-----TRP-C37M----MODBUS RTU/ASCII slave device.

Step2.Run DSM set up **TRP-C37M as Client**, Input destination IP and Port.

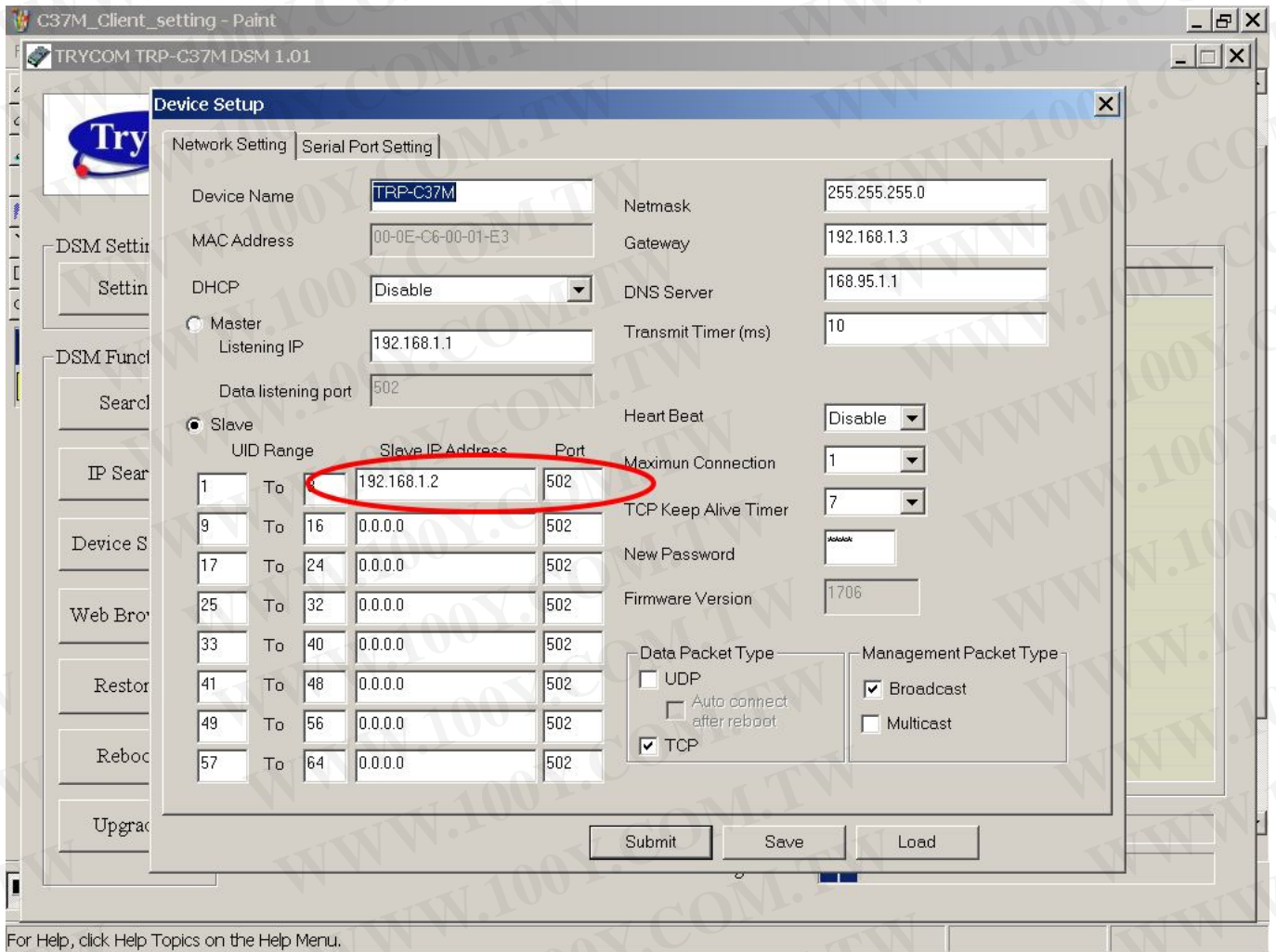

Step3.Run DSM set up **TRP-C37M as Server** and be sure the IP and port as same as client setting.

Network Setting | Serial Port Setting

Device Name: TRP-C37M

MAC Address: 00-0E-C6-00-01-E3

DHCP: Disable

Master

Listening IP: 192.168.1.2

Data listening port: 502

Slave

UID Range	Slave IP Address	Port
1 To 8	0.0.0.0	502
9 To 16	0.0.0.0	502
17 To 24	0.0.0.0	502
25 To 32	0.0.0.0	502
33 To 40	0.0.0.0	502
41 To 48	0.0.0.0	502
49 To 56	0.0.0.0	502
57 To 64	0.0.0.0	502

Netmask: 255.255.255.0

Gateway: 192.168.1.3

DNS Server: 168.95.1.1

Transmit Timer (ms): 10

Heart Beat: Disable

Maximum Connection: 1

TCP Keep Alive Timer: 7

New Password: *****

Firmware Version: 1706

Data Packet Type: UDP, Auto connect after reboot, TCP

Management Packet Type: Broadcast, Multicast

Same step3 and step4 same refer above.

6-5 Multi-Client to 1 TRP-C37M Server

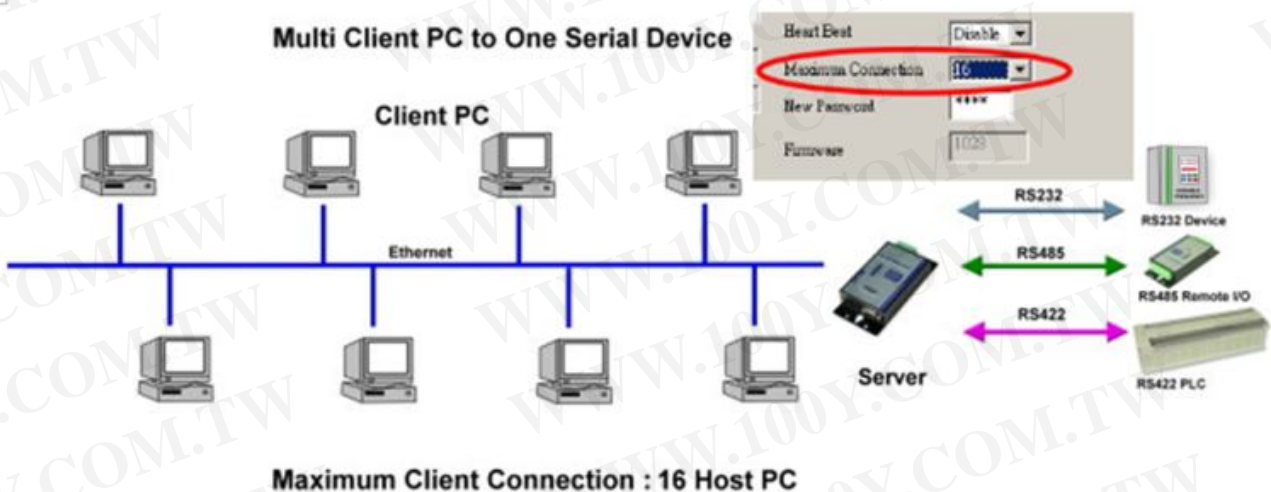

Example:

***Running at Multi-Direct IP Mode**

Step1. Connect Multi-PC ---Ethernet---TRP-C37M Server----TRP-C28 (RS485 ID=1)

Step2. Run DSM Set up **TRP-C37M** Maximum connection=16.

Step3.All host PC run Modscan32.

***Running in Multi-Virtual COM Mode**

Step1. All PC run Virtual com utility and make a self virtual-COM port, Run TRPCOM utility and select com port number, and press “OK”.

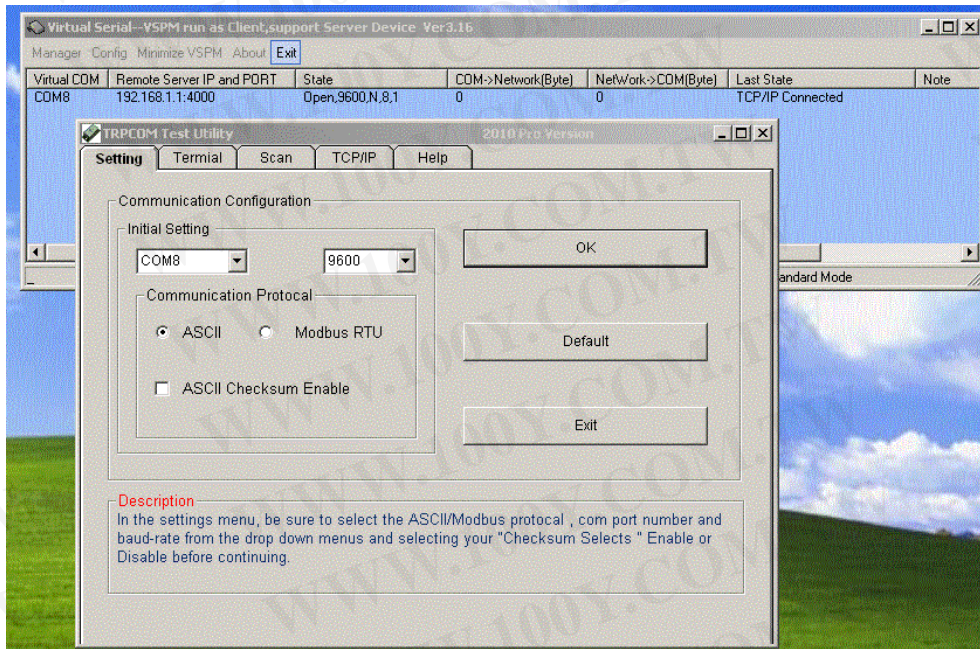

Step3.Select “Terminal” and send command, the response will appear TRP-C28 channel 2 counter value.

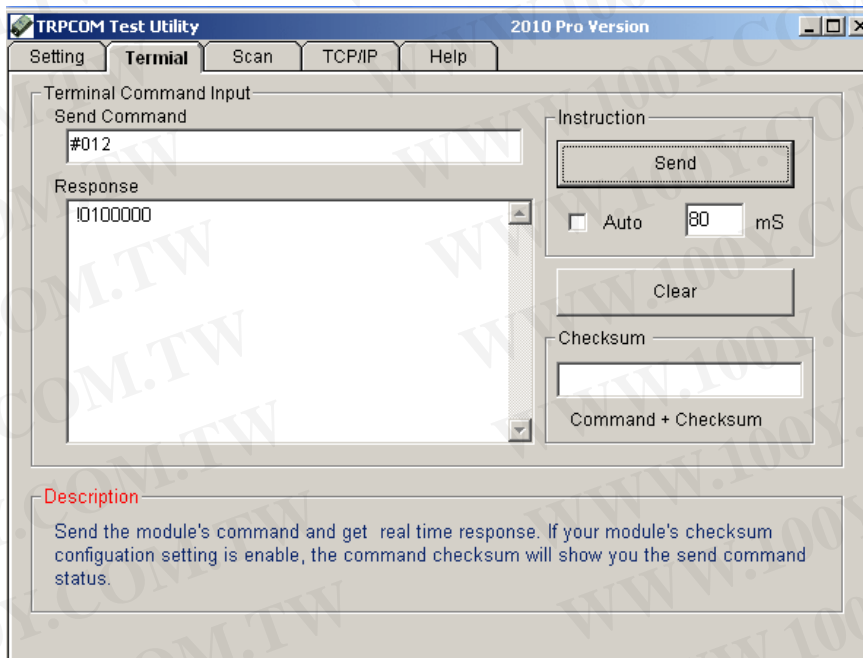

6-6 Heart Beat

The heart Beat function help customer detection the TRP-C37M LAN on-line or off-line, User can open one 5300 port, if TRP-C37M on line, the 5300 port will send a char starting period of 5 sec.

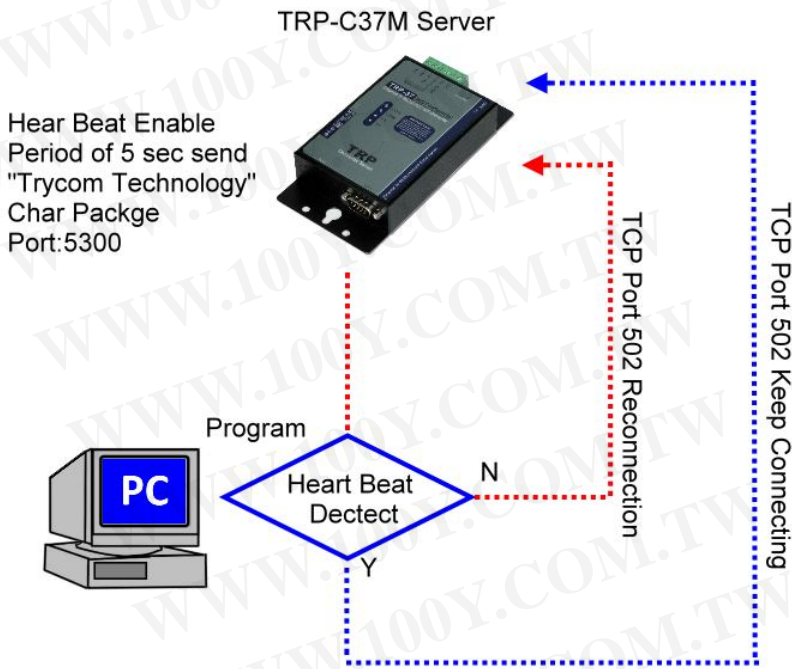

Step1: Run TRP-C37X DSM utility to set up the heart beat enable.

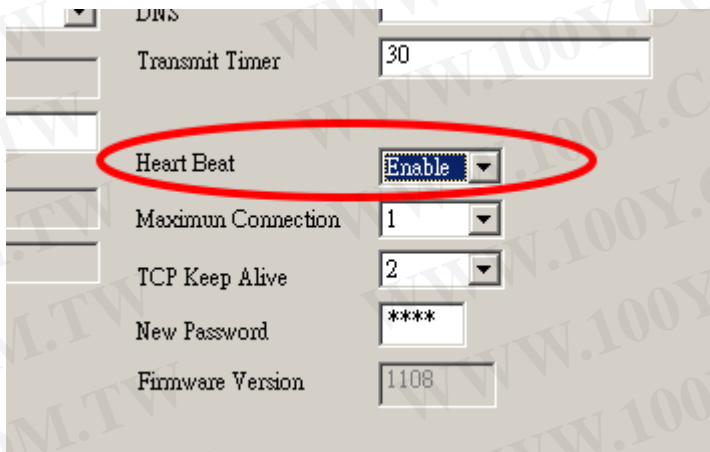

Step2: RUN TRPCOM then click "Link" button
Wait until the Response screen appear the message

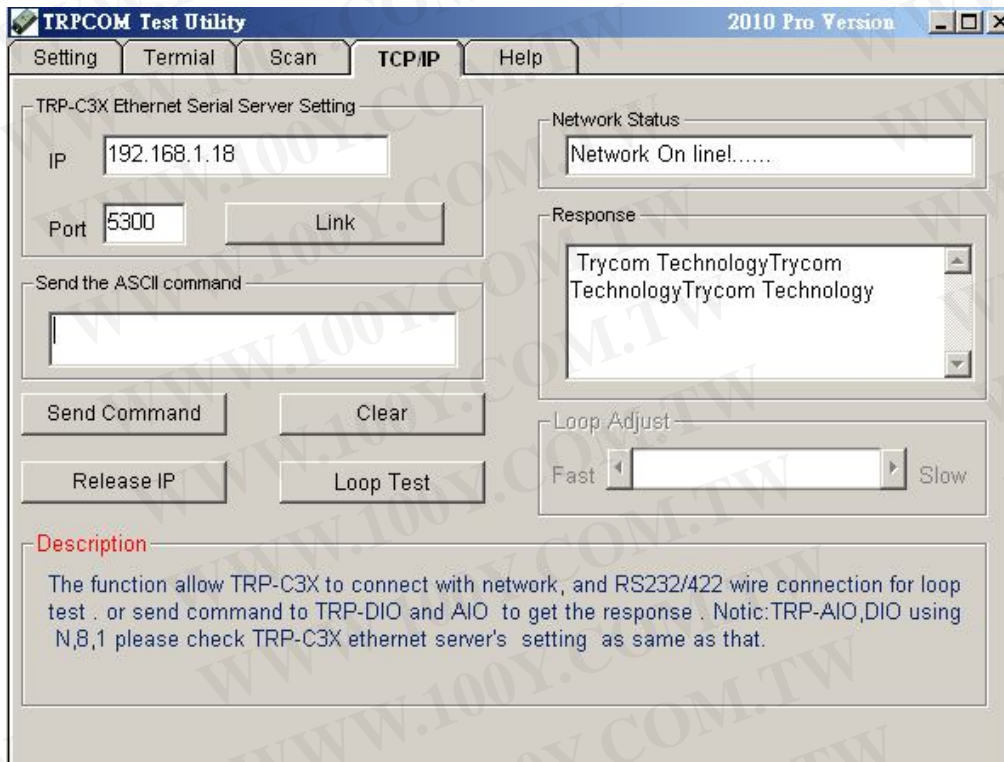

Step3: Click windows start then select Accessories then click "Command Prompt", type dos command telnet 192.168.1.1 5300

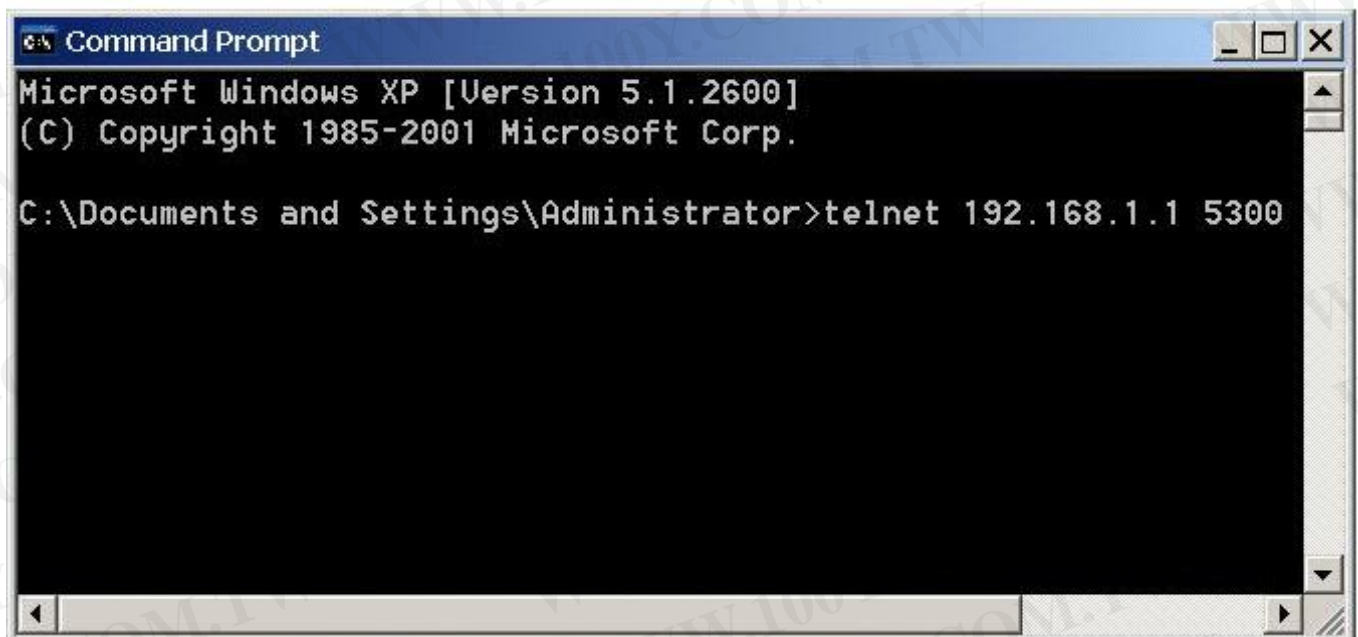

Wait until the Response screen appear the char message

7. Using TRPCOM Utility test TRP-C37M.

We recommend use the virtual-com mode test all RS232/422/485 function.

***Please turn the switch 1,2 to ON,OFF**

*Support all ASCII and Binary code includes MODBUS RTU/ASCII Protocol in Virtual-com Mode.

TRPCOM Utility is demo utility which may help to test TRP-C37M UART interface .User may

find the utility in the TRP-C37M support CD. Double click "TRPCOM Utility", the installShield Wizard will guide you complete installation.

User can directly link TRP-C37M to TRP-Serial Remote IO Modules by RS485, The basic wiring connect.

RS485 Test

DATA+ to DATA+, DATA- to DATA-

DATA+ to DATA+, DATA- to DATA-



How to operator please see the diagram below.

RS422 Loop back Test

Hardware connects wiring for RS422 loop test.

TX+ to RX+, TX- to RX-

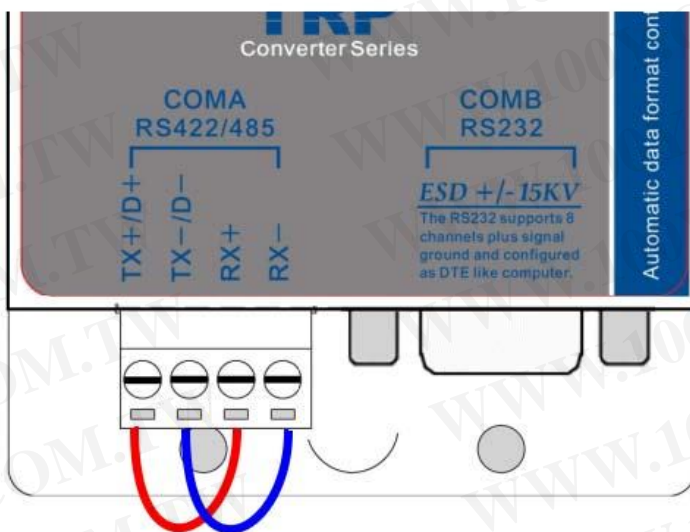

RS232 Loop Back Test

Hardware wiring connection for RS232 Loop Test.

TXD to RXD, RTS to CTS.

Pin2,3 Short
Pin7,8 Short

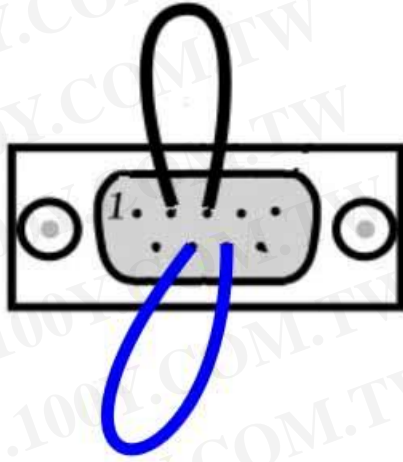

STEP1.RUN Virtual COM utility and set up the TRP-C37M IP and PORT.

STEP2.RUN TRPCOM test utility then select virtual-com port number.

STEP3.Select terminal and key-in some word at “send command” text filed.

STEP4.Click “Send Command” and get response.

Virtual Serial--VSPM run as Client,support Server Device Ver3.16

STEP1

Virtual COM	Remote Server IP and PORT	State	COM->Network(Byte)	Network->COM(Byte)	Last State
COM8	192.168.1.1:502	Can't Create:COM8,Ma...	0	0	Can't Create:COM8,Maybe it ...
COM9	192.168.1.1:502	Can't Create:COM9,Ma...	0	0	Can't Create:COM9,Maybe it ...

TRPCOM Test Utility 2010 Pro Version

STEP2

Setting | Terminal | Scan | TCP/IP | Help

Communication Configuration

Initial Setting

COM8 9600 OK

Communication Protocol

Standard Mode

TRPCOM Test Utility 2010 Pro Version

Setting | **Terminal** | Scan | TCP/IP | Help

STEP3

Terminal Command Input

Send Command

0123456789abcdefghijklmnopqrstuwxzy

Response

0123456789abcdefghijklmnopqrstuwxzy

Instruction

Send

Auto 80 mS

Clear

Checksum

Command + Checksum

Description

Send the module's command and get real time response. If your module's checksum configuration setting is enable, the command checksum will show you the send command status.

7. Application1.

Modbus TCP Master to Modbus RTU/ASCII serial Device



Modbus RTU/ASCII Serial Master to Modbus TCP Slave Device



7. Application 2.(As Bridge)

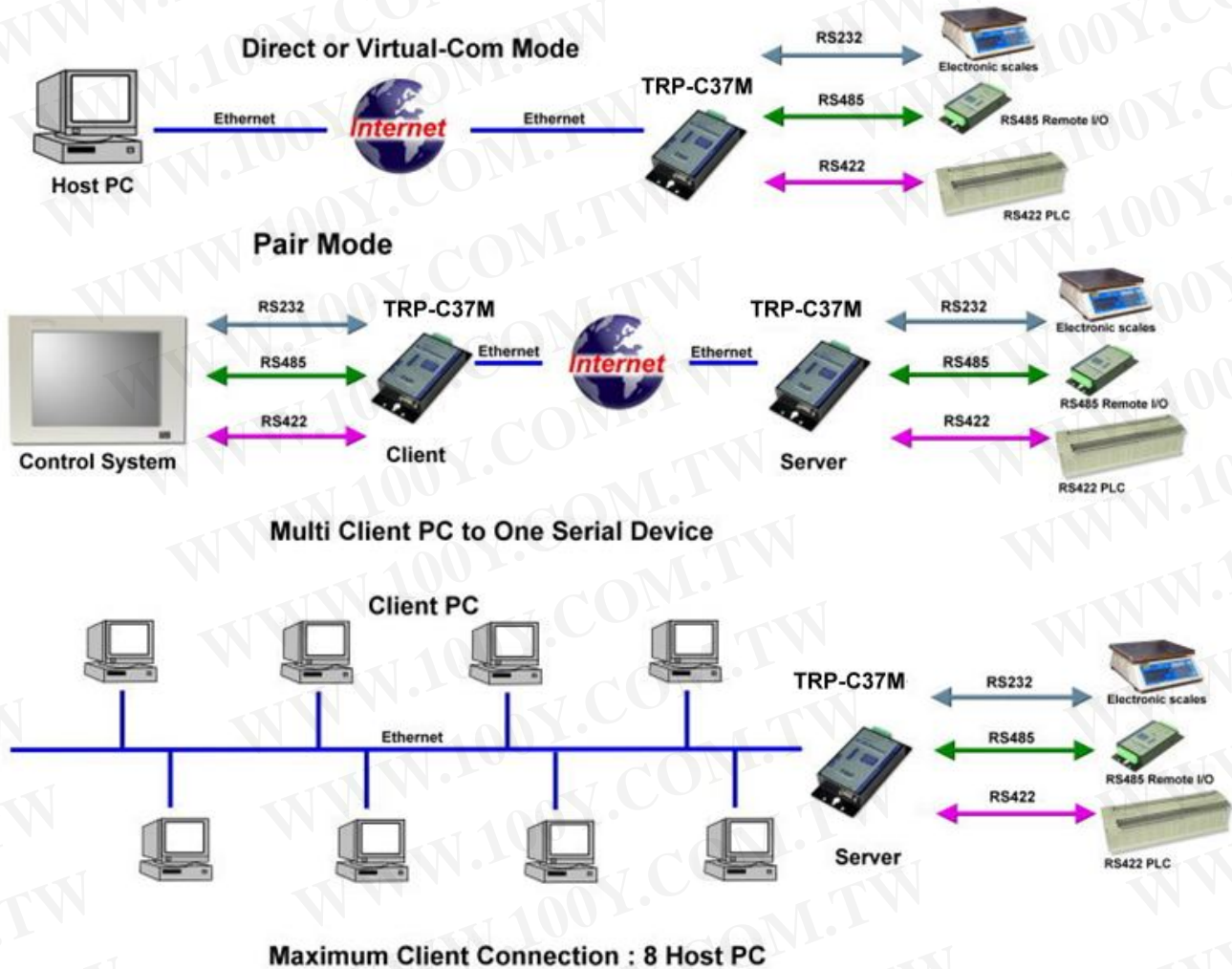

8. Appendix

What is different between TRP-C37 and TRP-C37M

TRP-C37 RS232/422/485 Serial Device Server

The TRP-C37 which is only to send the data between the TCP and Serial, it cannot process the data and perform operations.

This means that no matter what it received any data that can only be responsible for two-way Transmission.

TRP-C37M Modbus TCP to RTU/ASCII Gateway

The TRP-C37M which is able to analyzes the protocols between Modbus TCP and Modbus RTU / ASCII.

The TRP-C37M can assign the UID of Modbus TCP slave from Modbus Serial Master.

TRP-C37M has all the features of TRP-C37.