

TRP-C29U

8-channel isolated digital input and 8-channel isolated digital output(O.C) USB serial interface module, Support ASCII and Modbus Protocol.



勝特力材料 886-3-5753170
勝特力电子(上海) 86-21-34970699
勝特力电子(深圳) 86-755-83298787
[Http://www.100y.com.tw](http://www.100y.com.tw)

1.Introduction

TRP-C29U is USB to serial interface that provides with 8 optical isolated digital input channels and 8-channel digital output open collector. All channel features screw terminals for convenient connection of field signals as well as LED's to indicate channel status. Input channels are equipped with 3750Vrms DC isolation . For easy user access, TRP-C29U can enter configuration mode and self-test mode with outer dip-switch. TRP-C29U support both ASCII and Modbus protocol, with a full set of command, dual watch-dog, and auto reset function. the module can be bi-directionally remote controlled by PC in ASCII or Modbus RTU protocol.

1-1.Features

- USB directly power supply input.
- System get a serial com port when USB plug in.
- Support ASCII and Modbus RTU protocol.
- Supports baud rates from 1.2Kbps to 115.2 Kbps.
- All 8 channels digital input can be used as counter.
- Digital input signal with 3750Vrms isolation protection.
- Dual watchdog: Module's firmware, host computer traffic.
- LED for each channels working status.
- DIN rail and panel mount support.
- Driver Support: Android/Win8.1/Vista64/32,Windows 98/ME/2000/XP/WIN 7/CE5.0~7.0, and Linux, and Mac OS. Configured and self-test by outer dip-switch.

1-2.Specifications

- Built-in USB 2.0 to serial bridge.
- Input channel: 8 digital input channels.
- Input optical isolation: 3750 Vrms.
- Input logical level 0 +/-1V (max).
- Input logical level 1 +/- 4.0V ~ +/-30V.
- Digital Input can be used as counter channel:8
- Input counter: Dec 0~65535(max) or Hex 0000~FFFF (max).
- Input impedance: 3Kohm.
- Input Counter frequency: 100Hz.
- Input distance: 500M (max).
- Digital output Maximum voltage: +/-30V.
- Digital output Maximum current: 100 mA.
- Digital output isolation: 3750Vrms.
- Communication interface: USB to serial .
- Communication speed: Baud rate from 1.2kbps to 115.2Kbps.
- Dual watchdog: Hardware reset circuit, module and host operating status.
- Signal LED: Power on, all channels.
- Power supply: Directly input from USB.
- Connection type: Screw terminal, accepts AWG #12~32 wires
- Power consumption: 1.2W.
- Operating environment: -10 to 50°C.
- Storage temperature: -20 to 70°C.
- Humidity: 10-90% Non-condensing.
- Dimension: 151mm X 75mm X 26mm .
- Weight: 400g.

勝特力材料 886-3-5753170
勝特力电子(上海) 86-21-34970699
勝特力电子(深圳) 86-755-83298787
[Http://www.100y.com.tw](http://www.100y.com.tw)

1-3. Panel Layout

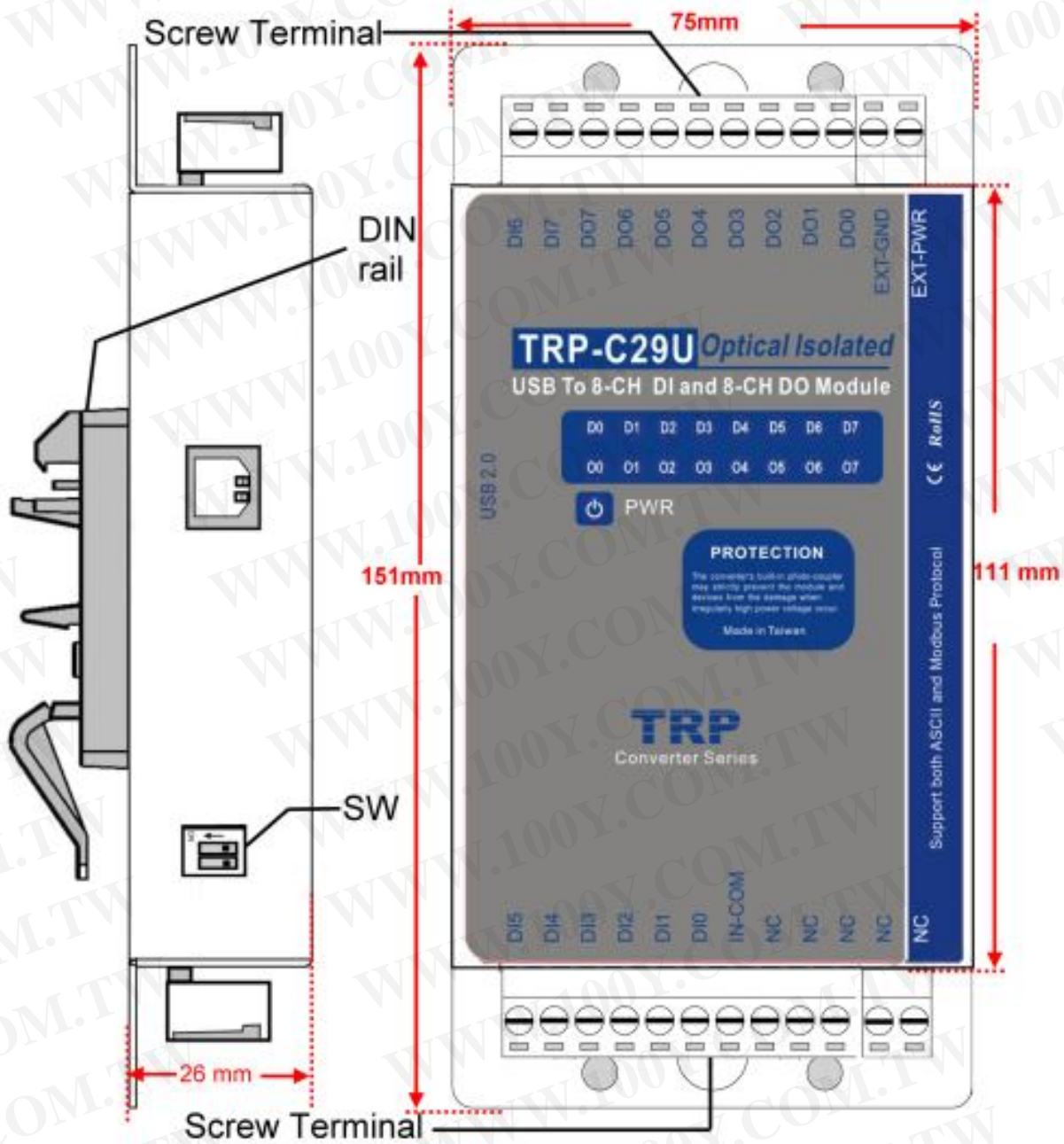

勝特力材料 886-3-5753170
勝特力电子(上海) 86-21-34970699
勝特力电子(深圳) 86-755-83298787
[Http://www.100y.com.tw](http://www.100y.com.tw)

1-4. Block Diagram

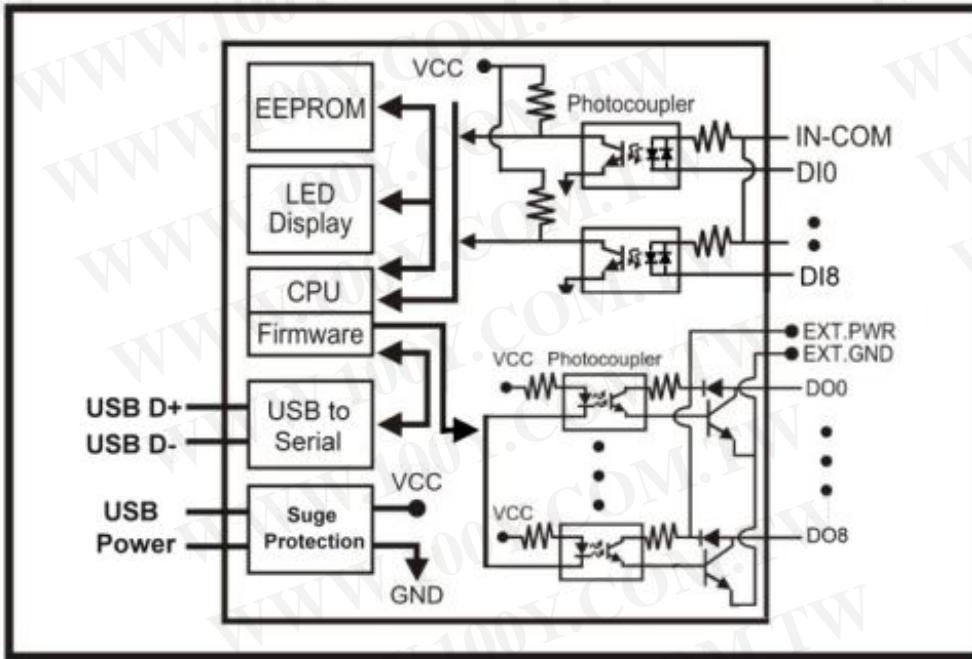

1-5. Pin Definitions

DI5	Digital Input CH 5	DI6	Digital Input CH 6
DI4	Digital Input CH 4	DI7	Digital Input CH 7
DI3	Digital Input CH 3	DO7	Open Collector output CH7
DI2	Digital Input CH 2	DO6	Open Collector output CH6
DI1	Digital Input CH 1	DO5	Open Collector output CH5
DI0	Digital Input CH 0	DO4	Open Collector output CH4
IN_COM	External Voltage for Digital Input	DO3	Open Collector output CH3
NC	None	DO2	Open Collector output CH2
NC	RS485+	DO1	Open Collector output CH1
NC	RS485-	DO0	Open Collector output CH0
NC	Input Voltage 10~30V	EXT-GND	External Voltage Ground for DO
NC	Input Voltage Ground	EXT-PWR	External Voltage Power for DO

2-1. Communication Wiring



2-2. Wire Connection

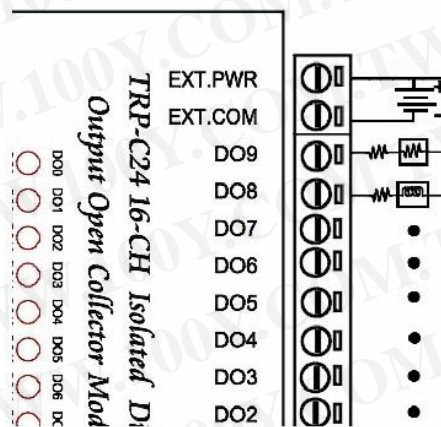
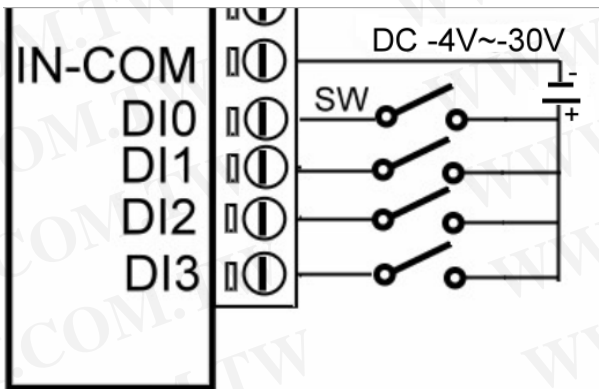
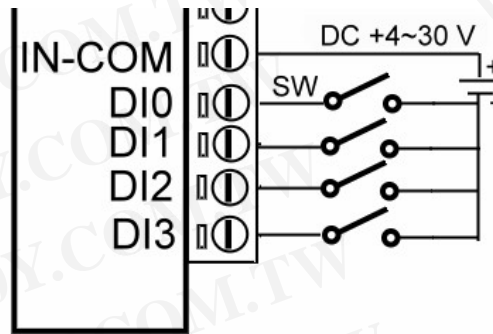
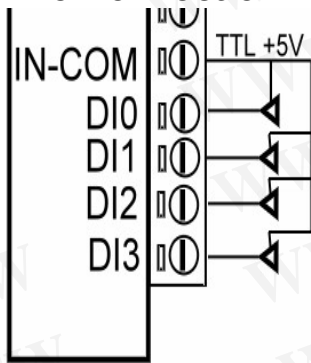

3. USB to serial Driver Install

***Notice: When you finished the TRP-C29U USB to serial driver install, the O.S will detect dual serial ports. For TRP-C29U there only one set of serial port can be use and the other one set of serial port is non-function**

1. Power on your computer and boot to Windows.
2. Put the driver CD in the CD-ROM then select the driver of O.S you want (See figure1)

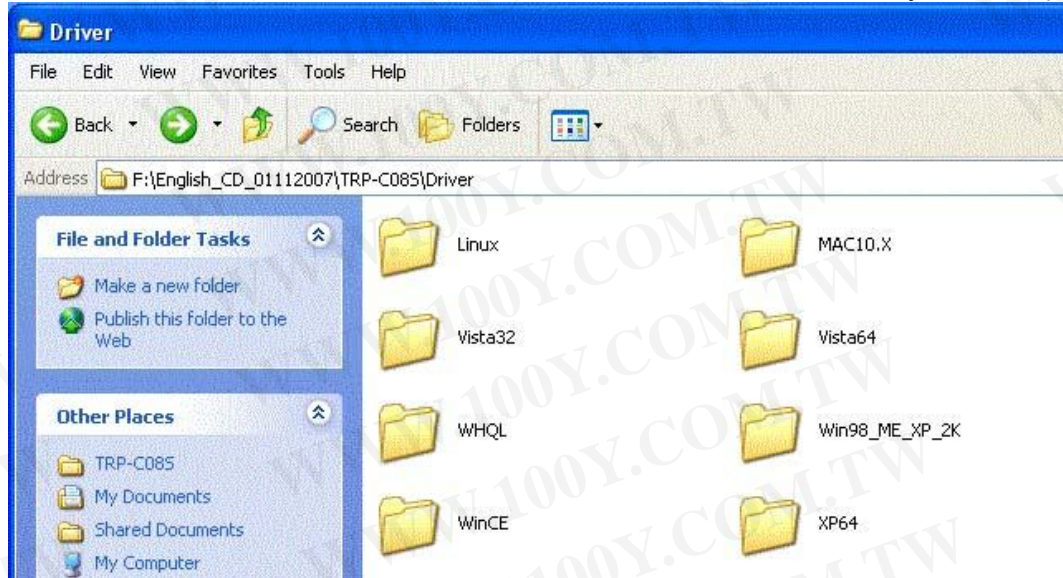

Fig.1

3-1 .Install Vista32/64 driver

Find "MSSetup.exe" utility which in the Vista64 folder. Double click on MSSetup.exe to start the installation process. Make sure that the User installing the driver must be a member of the Administrator group on the system

You will get a "User Account Control" window saying "An unidentified program wants access to your computer". Click on *Allow* to continue installing the Driver.

You will get an installation window as below, press "Install" button to install the drivers for High-Speed USB Multi Serial Device.



During the installation process, a "Windows Security" warning message pops up informing that "Windows cannot verify the publisher of this driver software". Ignore the warning message by clicking on the option "install this driver software anyway".

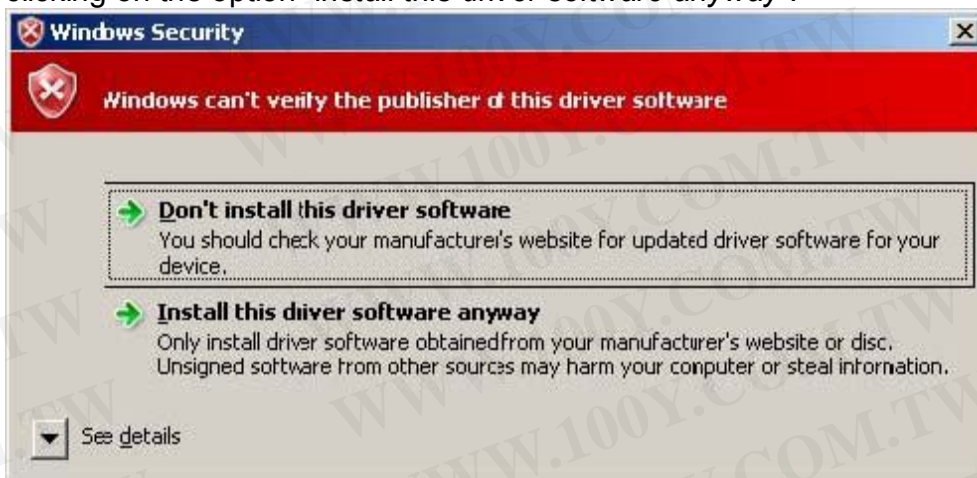

You will get the above message two times and you have to select "install this driver software anyway". The utility displays a message stating "Installation completed". Use "Exit" button to complete the driver installation.



3-1-1. TRP-C29U Device Installation & Detection:

Connect TRP-C29U to the USB Host controller of the PC using a USB cable. The first time you plug-in the cable into the USB port, Windows will start installing the device driver software. You can see the installation status at the pop-up message of system tray. After installation, the pop-up message says “Your devices are ready to use”, *Device driver software installed successfully*.

TRP-C29U device detection can be confirmed by checking at the Device manager. Check for “High-Speed USB MultiSerial Compound Device” under *Universal Serial Bus controllers* and you will find “MosChip High-Speed USB Serial Port (ComX)” under the category *Ports (COM & LPT)*. Here ‘X’ in ‘ComX’ represents the serial port number. You can see the same in the figure below.

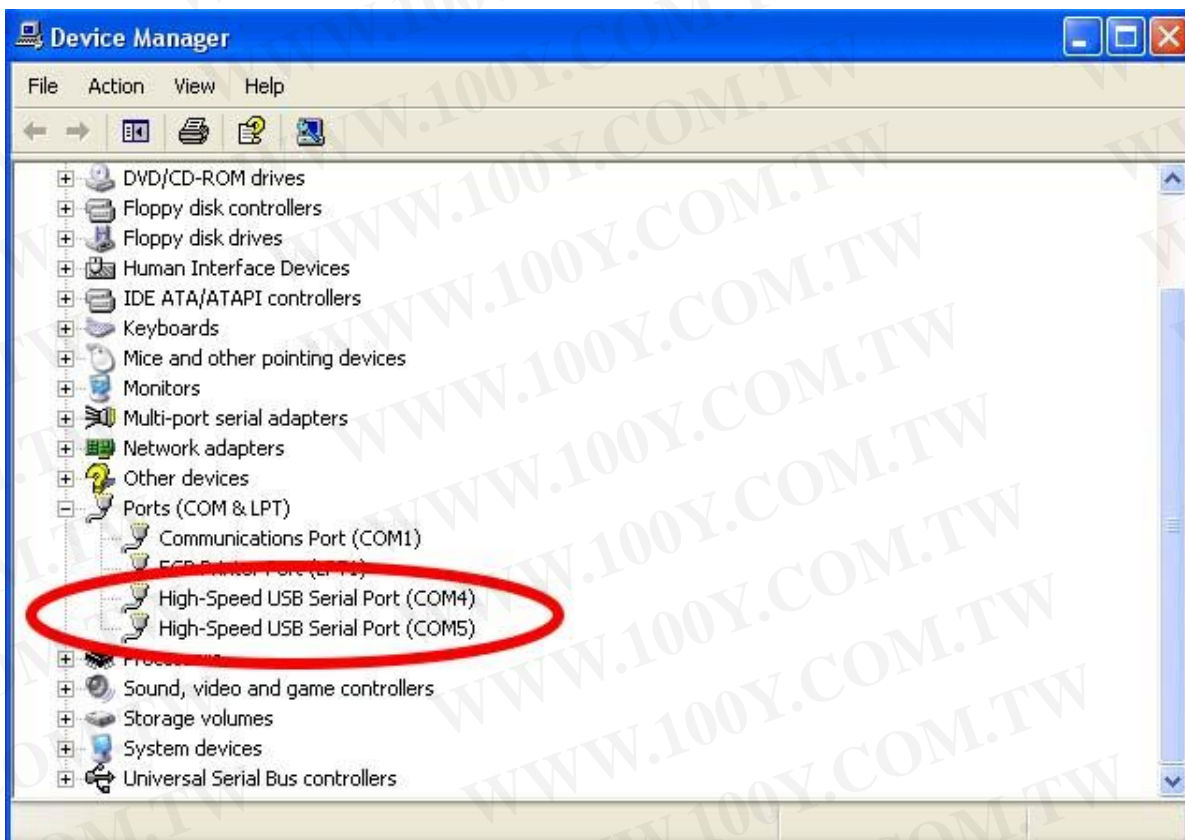

3-2 .Install XP driver

Find MSSetup.exe and MSUninst.exe which in the folders for Win XP/2K and Win98/ME operation system.

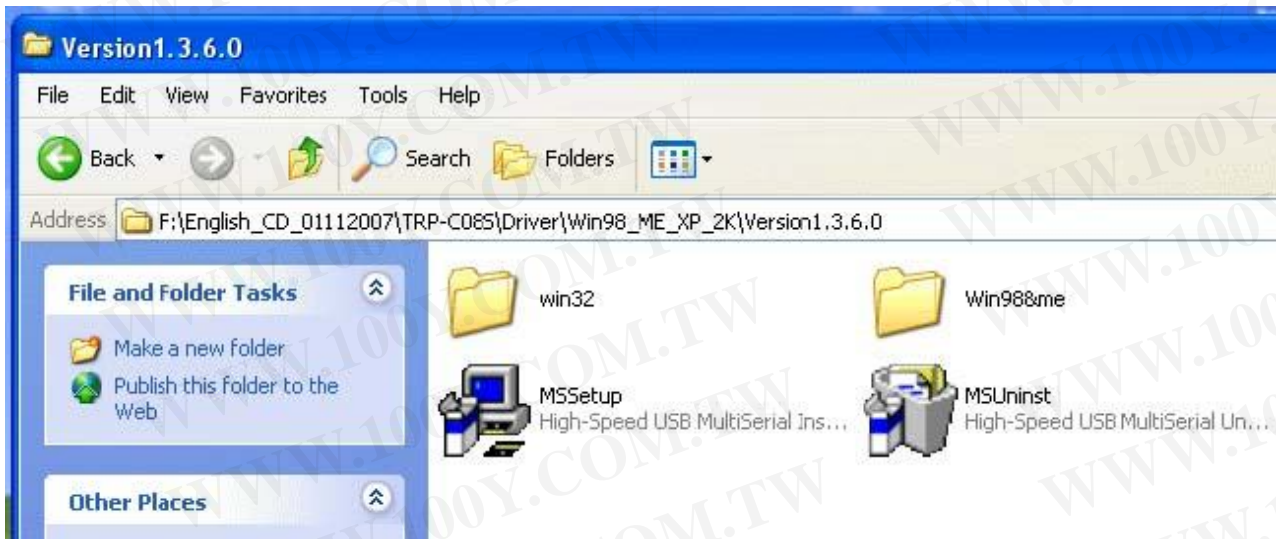

Use “MSSetup.exe” utility to install the driver. Double click on the utility to start the installation process. Press “Install” button to install the drivers for High-Speed USB Multi serial Device.



During the installation process, a warning message will popup informing the user that the software being used has not passed the Windows Logo testing. You can ignore the warning message by clicking on the option “**Continue Anyway**”.



The utility will display a message stating "Installation completed". Use "**Exit**" button to complete the driver installation.



Connect TRP-C29U to the USB Host controller of the PC by using a USB cable. The first time you plug the adapter into the USB port, Windows will bring up the "**Found New Hardware Wizard**" window to guide you through the initial configuration process. Select the option "**No, not this time**" and click on "**Next**" button to continue.

The following wizard helps you install the software for "High-Speed USB Multi Serial Compound device". Select the option "**Install the software automatically**" and click on "**Next**" to proceed further.



As specified in earlier section, a warning message will popup informing the user that the software being used has not passed the Windows Logo testing. You can ignore the warning message by clicking on the option “**Continue Anyway**”.



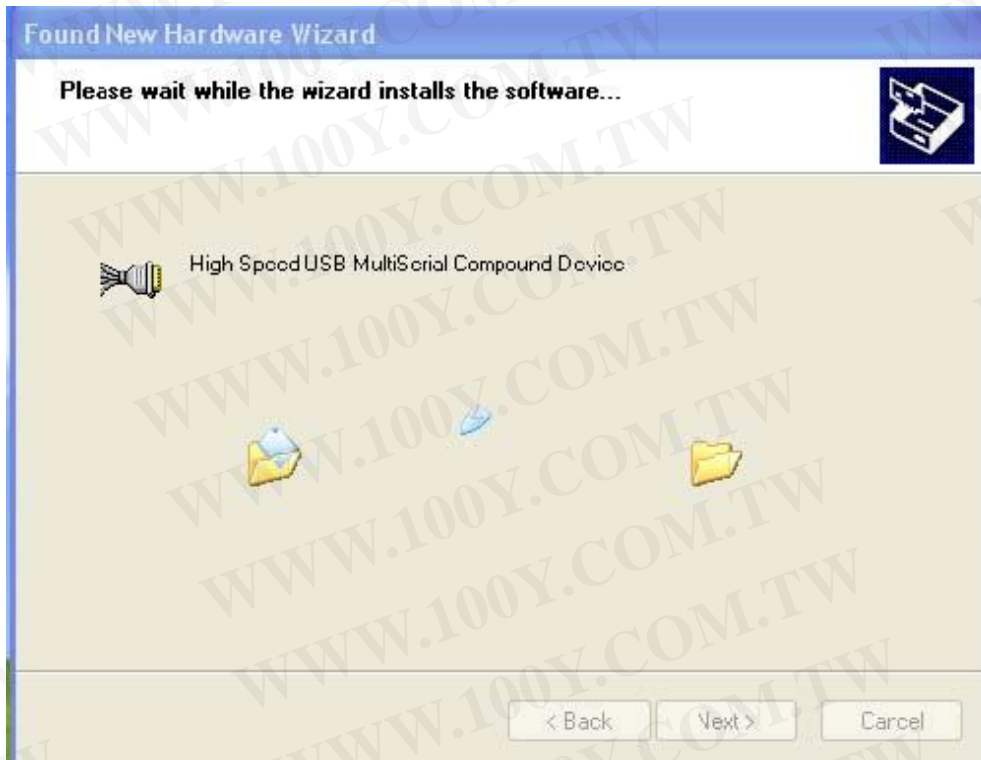

The following window conveys that the OS had finished the software installation for “High-Speed USB Multi Serial Compound Device”. Click on “**Finish**” to complete found new hardware wizard.



Follow the same steps as explained for “High-Speed USB Multi Serial Compound Device” for the second port installation . Select the option “**Install the software automatically**”



“Continue Anyway”



The following wizard indicates that the OS has completed installing the software for the first serial port. Continue the same process for installing the rest of the serial ports.



TRP-C29U device detection can be confirmed by checking the Device manager. Check for “High-Speed USB Multi Serial Compound Device” under Universal Serial Bus Controllers and “High-Speed USB Serial Port (Com X)” under the category Ports (COM & LPT)

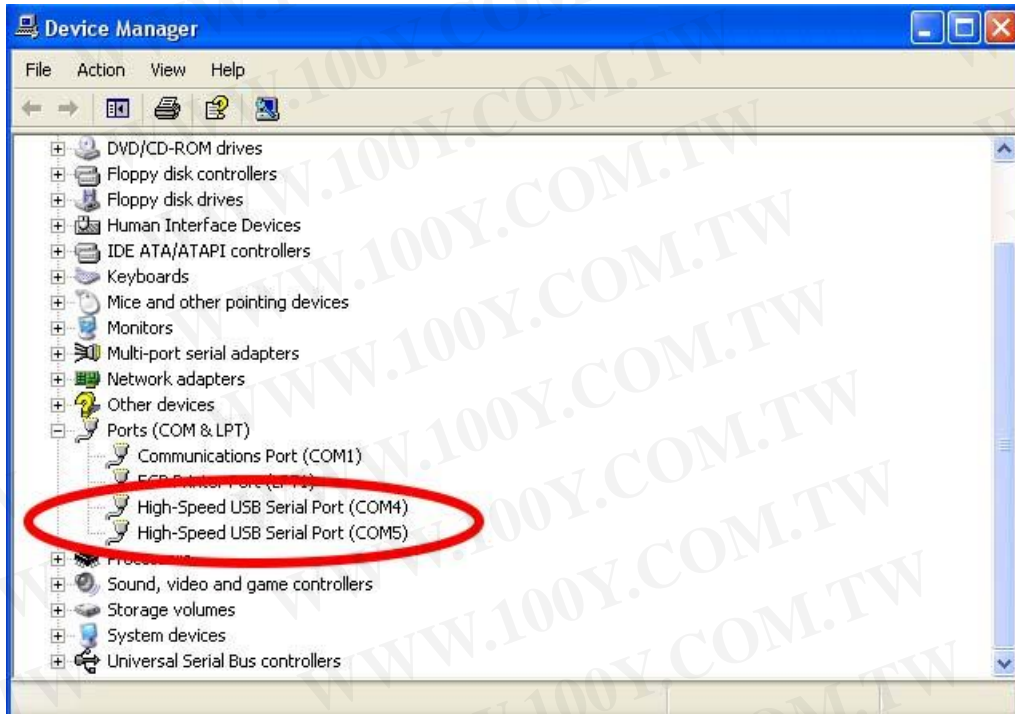

Now the TRP-C29U Device is ready to use.

3-3 .Uninstall XP driver Use “MSUninst.exe” to uninstall the TRP-C29U device driver from your PC. Double click on the utility to run the Uninstaller. Click on **OK** to proceed further.



Use the “Exit” button to complete the Uninstaller utility. No need to restart the PC, unless prompted by the OS. The driver can also be uninstalled from **Control panel – Add / Remove Programs**. Select the “High-Speed Multi Serial Compound Device” from the Add / Remove panel and click on “**Remove**” option. This will remove the MCSTRP-C29U device driver from the PC.

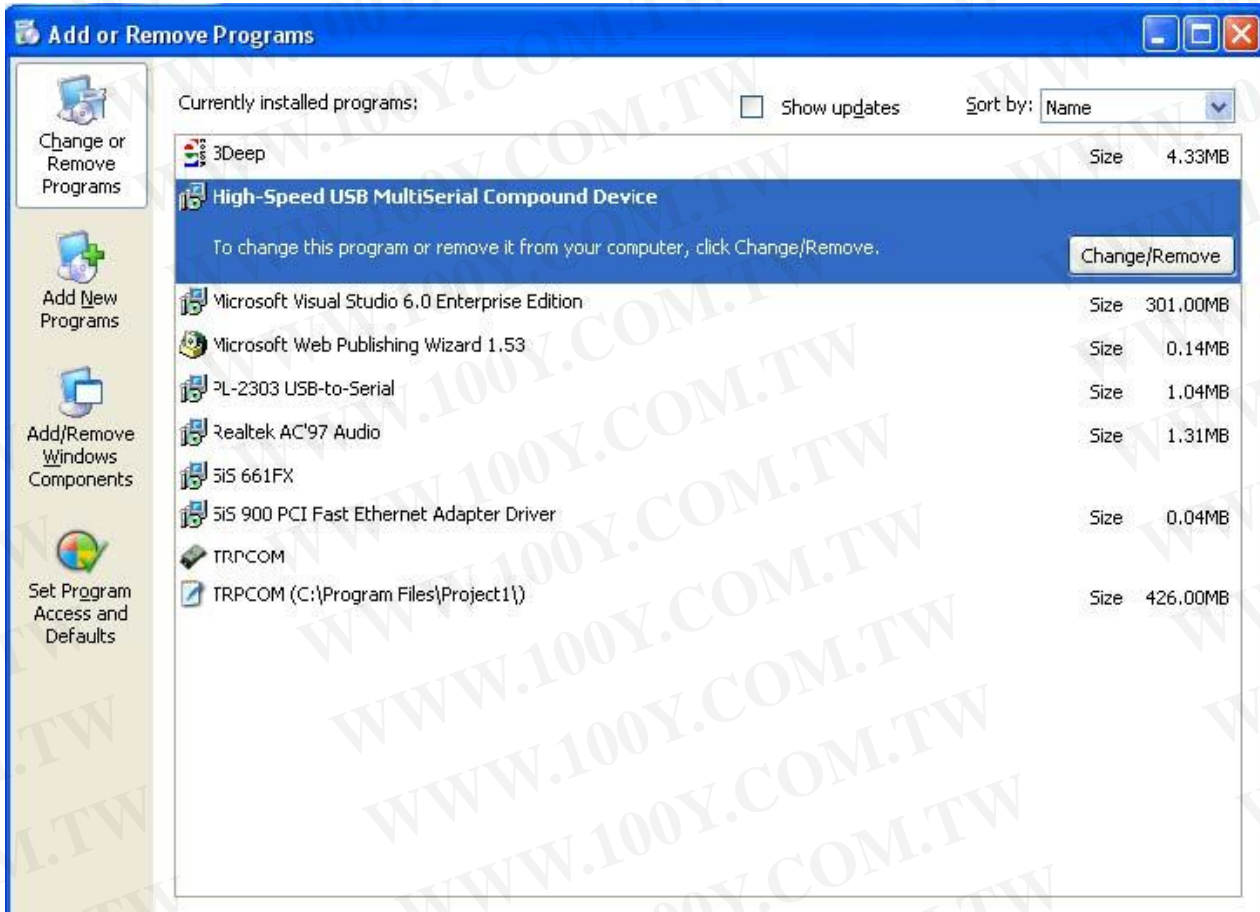

The TRP-C29U device driver can be un-loaded through “**Device Manager**” as well. Go to Device Manager, Select High-Speed USB Multi Serial Compound Device from the Universal serial Bus controllers, Right Click on it, Select “**Uninstall**” as shown below.

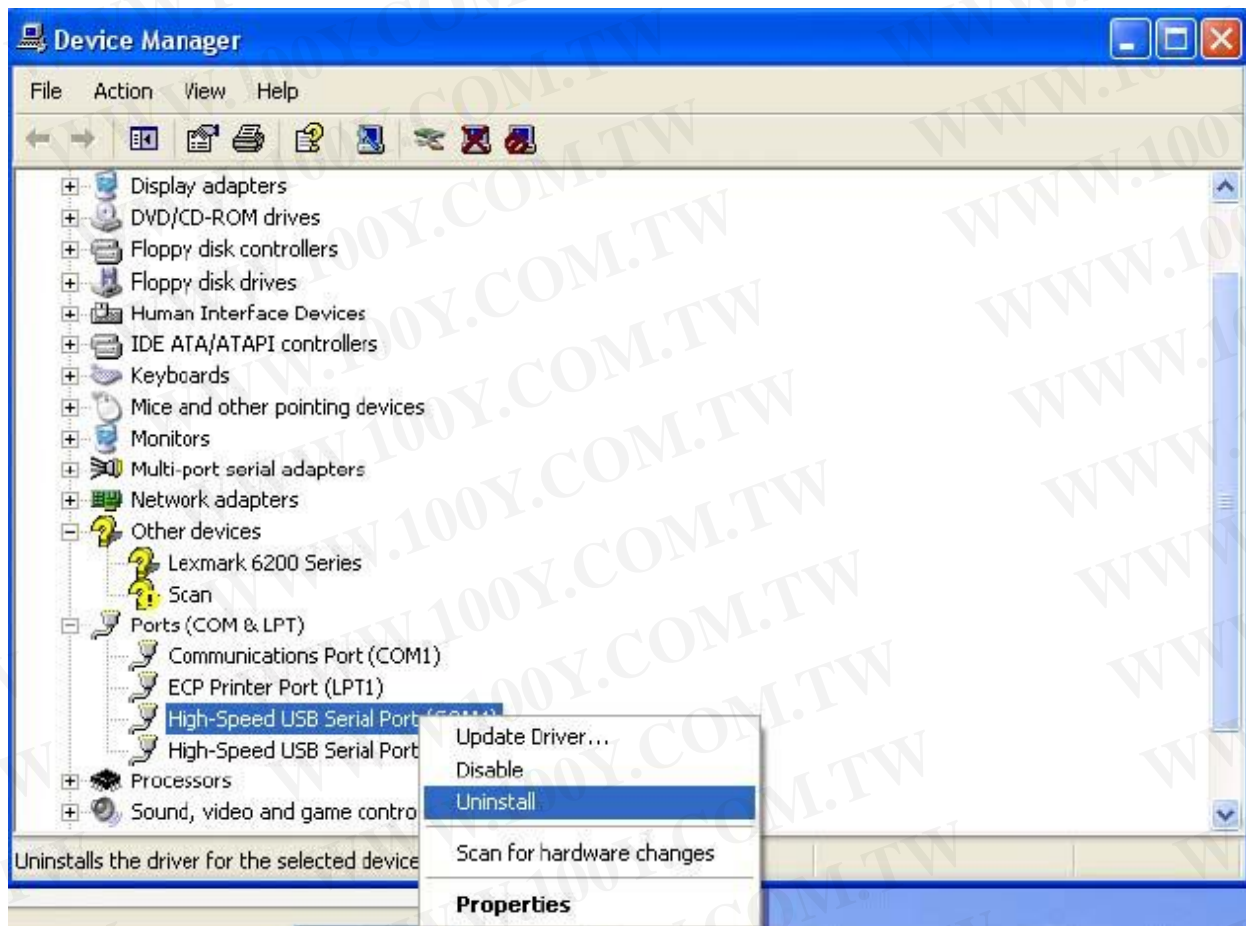

The OS will prompt the user whether to uninstall the device from the system. Click on “OK” to uninstall or “Cancel” to terminate the un-installation.

The Win2K software Installation, Detection and Un-Installation procedures are same as Win XP OS process. The only difference being, there is no need of user intervention during the detection of MCSTRP-C29U. When you connect MCSTRP-C29U to the USB, Win 2000 OS will automatically detect the device without interference of the user.

4. System Configuration Switch

The TRP-C29U support the Modbus RTU and ASCII communication protocol, It has a two pins external dip-switch that allow user to select protocol between Modbus/RTU and ASCII. The dip-switch also provides “back to default” function when user forget the configuring information stored in EEPROM such as ID (RS-485 Module address), baud rate and data format.

Default setting:

ID Address: 01,

Baud Rate: 9600,

DIO Mode Type: 40,

Checksum: Disable,

RS485 Communication data format: N, 8, 1.

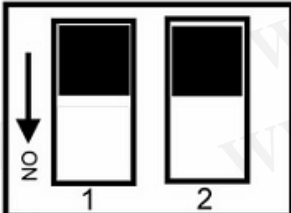
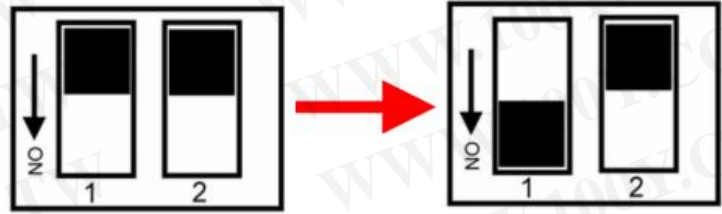
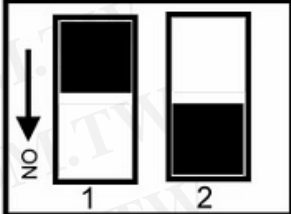
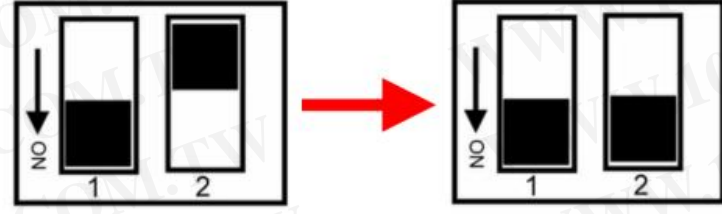
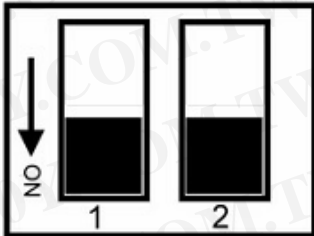
	<p>Modbus Protocol (Factory) Modbus Communication Protocol.</p>
	<p>Back to INIT for Modbus 1. Adjust the switch to “off off” position 2. Adjust the switch to “on off” position 3. Reboot.</p>
	<p>ASCII Protocol ASCII communication protocol.</p>
	<p>Back to INIT for ASCII 1. Adjust the switch to “on off” position 2. Adjust the switch to “on on” position User may adjust the switch in power on status, no system reboot require.</p>
	<p>Enter self- test mode Adjust the switch to on on then reboot.</p>

*INIT: ID=00, Baud-Rate: 9600, Data format: 00, Checksum=disable.

5. Function description

Power on mode: When power fail, system reset or host watchdog timeout will cause the module reboot then into power on mode, the module's digital output value will return to the before setting. And module can accept the host's command to change the digital output value.

Dual Watchdog: Module self watchdog: The module's watchdog is a hardware reset circuit while working in harsh or noisy environment, the module may be down by the external, The circuit may let the module to work continues and never halt.

Host watchdog: The host watchdog is software function to monitor the module's output states to prevent the module from communication problem or system halt due to unexpected situation, It's purpose is to prevent the RS485 network from communication problem or host halt. When the timeout interval expired, the module will turn all output to predefined safe value. This can prevent the controlled target from unexpected situation.

Safe mode: If the user install the watch-dog enable on the RS485 line, The host will send the reset module's watchdog command one by one, when the host is not send the command (May be is RS485 off line or host halt), the module will watchdog timeout then into the safe mode, if the module into the safe mode, the digital out will not be changed until the watchdog disable.

6. TRPCOM ASCII Command Protocol Description

Command Format : "Leading Code"+"ID Address"+"Command"+"CHK"+(cr).

Response Format : "Leading Code"+"ID Address"+"Data"+"CHK"+(cr).

7. How to Calculate the Checksum

1. Calculate all characters of the command string to get the ASCII sum, except the character return.
2. Mask the sum of string with 0FFH.

Example:

Send the command is "\$06M".

Sum of string is "\$"+"0"+"6"+"M"="24H"+"30H"+" 4D"="A1H".....The checksum and [CHK]="A1".

Response string with checksum is: " A1 ".

8. Command List

Command List	Function Description	Page Index
%IDNPPBDD(CHK)(cr)	Set the module's configuration	See 8-1 ~ 8-3
#IDPPFD(CHK)(cr)	Digital output data	See 8-4
#IDN(CHK)(cr)	Read digital input N channel counter value	See 8-5
#IDCN(CHK)(cr)	Clear digital input N channel counter value	See 8-6
#IDCW(CHK)(cr)	Clear all digital input counters value	See 8-7
#IDCS(CHK)(cr)	Save all digital input counters value to EEPROM	See 8-8
\$IDLS(CHK)(cr)	Read digital input latched	See 8-9
\$IDC(CHK)(cr)	Clear digital input latched	See 8-10
\$ID6(CHK)(cr)	Read digital input/output status	See 8-11
\$ID2(CHK)(cr)	Read the TRP-C29U configuration	See 8-12
\$IDRS(CHK)(cr)	Reset	See 8-13
\$IDM(CHK)(cr)	Read the module's name	See 8-14
\$IDF(CHK)(cr)	Read the module's firmware version	See 8-15
\$ID5(CHK)(cr)	Read the module reset status	See 8-16
~IDONN(CHK)(cr)	Change the module's name	See 8-17
~IDLEDA(CHK)(cr)	Set the module's LED operating mode	See 8-18
~IDWENN(CHK)(cr)	Enable watchdog and set the timeout value	See 8-19
~IDWD(CHK)(cr)	Disable watchdog	See 8-20
~IDWR(CHK)(cr)	Read watchdog timeout value	See 8-21
~**(CHK)(cr)	System stand by (Host OK!)	See 8-22
~ID4V(CHK)(cr)	Read power on/safe value	See 8-23
~ID5V(CHK)(cr)	Save current digital output status to power on or safe mode	See 8-24
#**(CHK)(cr)	Save current digital input status	See 8-25
\$ID4(CHK)(cr)	Read synchronized data	See 8-26

*We offer the utility to guide you to configure the module; the utility is with on-line RS485 modules scanning and searching function. You can find the utility in the CD which bundled in TRP-C29U standard package.

8-1. Configure TRP-C29U

Command	%IDNNPPBBDD(CHK)(cr)	
Syntax Description	%	First leading code
	ID	Address of setting module 00-FF(HEX)
	NN	New address of setting from 00-FF(HEX)
	PP	The Digital I/O module type define to 40
	BB	Set new baud rate (See 8-2)
	DD	Data format (See 8-3)
	CHK	Checksum
	(cr)	Carriage return
Response	!ID(CHK)(cr)	Command valid
	?ID(CHK)(cr)	Command Invalid

8-2. Baud rate setting (BB)

Code number	03	04	05	06	07	08	09	0A
Baud rate	1200	2400	4800	9600	19200	38400	57600	115200

8-3. Data format setting (DD)

Bit	7	6	5	4	3	2	1	0
Function	Input counter *0:Rising 1:Falling	Checksum *0:Disable 1;Enable	0	0	0	0	0	Counter Display Mode *:0:Normal (Dec) 1:Engineer Mode (Hex)

*Default

Example:

Send command:"%0001400600"...

New ID is "01",D I/O type is "40",Bard-Rate:9600,Checksum setting disable is "00",
Response:"!01".

**If you adjust the switch to "ON ON", the ID will be back to *INIT*

Example:

Send command:"%000340054"

New ID="03",Bard-Rate="4800",Checksum="Enable",Response:"!03".

Example:

Send command:"%000340054"

New ID="03",Bard-Rate="4800",Checksum="Enable",Response:"!03".

Example:

Send command:"%0101400601"

New ID="01",Bard-Rate="9600",Checksum="Disable", Counter mode=hex,Response:"!01"

Then send "#010".....read counter value

Response: !01001B".....counter value=1B(HEX)

8-4. Digital output data

Command	#IDPPDD(CHK)(cr)	
Syntax Description	#	First leading code
	ID	Address of setting module 00-FF(HEX)
	PP	Output command parameter:00,0A Multi-channel :1L:Single channel (L=0~F)
	DD	DD: send the data from 00~FF output
	CHK	Checksum
	(cr)	Carriage return
Response	>(CHK)(cr)	Command valid
	!ID(CHK)(cr)	Parameter invalid (*Command data error!)
	?ID(CHK)(cr)	Command Invalid

Multi-Channel mode (Output control for one BYTE)*Example:**

Send command :"#010A2F".....Data="2F":DO8~DO0="0010 1111",.

Response:">"..... Command valid.

Example:

Send command:"#0100A8".....Data="A8":DO8~DO0="1010 1000"

Response:">"..... Command valid.

Example:

Send command:"#01000G"....Data="0G".....Data error!.

Response:"!01".....Parameter error!.

***Single-Channel mode(Output control for one BIT)**

Example:

Send command:"#011001"..... Data="01":DO0="1".

Response:">"..... Command valid.

Send command:"#011201"..... Data="01":DO2="1".

Response:">"..... Command valid.

Send command:#011700.....Data="00":DO7="0".

Response:">".....Command valid.

*1:Digital output enable,0:digital output disable.

8-5. Read digital input N channel counter value

Command	#DN(CHK)(cr)	
Syntax description	#	First leading code
	ID	Address of setting module 00-FF (HEX)
	N	Digital input channel from channel 0-3
	CHK	Checksum
	(cr)	Carriage return
Response	IIDCCCC(CHK)(cr)	Command valid CCCCC from 0 – 65535 (DEC)
	?ID(CHK) (cr)	Command Invalid

Example:

Send command:"#012".....Read the TRP-C29UM channel 2 counter value.

Response:"!0100023".....The digital input have been trigger 23 times.

*Unless you save value to EEPROM by using the command "#IDCS". The counter's value will reset to 0 if power fail or send command "\$IDRS".

8-6. Clear digital input N channel counter value

Command	#IDCN(CHK)(cr)	
Syntax Description	#	First leading code
	ID	Address of setting module 00~FF(HEX)
	C	Clear N channel counter value to 0
	N	N=0-7 *Channel DI0~DI7 digital input
	CHK	Checksum
	(cr)	Carriage return
Response	!ID(CHK)(cr)	Parameter invalid
	?ID(CHK)(cr)	Command Invalid

Example:

Send command: "#01C2", Clear CH2 counter value to 0.

Response: "!01".

*If counter's value already been reset to 0 you must use command "#IDCS" to save the new value in EEPROM again, or the module will load old value if power fail or reset.

8-7. Clear all digital input counters value

Command	#DCW(CHK)(cr)	
Syntax description	#	First leading code
	ID	Address of setting module 00-FF(HEX)
	CW	Clear all digital input counters value
	CHK	Checksum
	(cr)	Carriage return
Response	!ID(CHK)(cr)	Command valid
	?ID (CHK)(cr)	Command Invalid

Example:

Send command: "#01CW", Clear DI0-DI7 counter value to 0.

Response: "!01".

* After the command "#IDCW" you must save new value in EEPROM again, or the module will load old value if power fail or reset.

8-8. Save all digital input counters value to EEPROM

Command	#DCS(CHK)(cr)	
Syntax description	#	First leading code
	ID	Address of setting module 00-FF(HEX)
	CS	Save all channels counter to E2PROM
	CHK	Checksum
	(cr)	Carriage return
Response	!ID(CHK)(cr)	Command valid
	?ID(CHK)(cr)	Command Invalid

Example:

Send command "#01CS", Save DI0-DI7 counters value to EEPROM.

Response: "!01".

Then after power fail or reset

Send command: "#010".....Read DI0 counter value.

Response: "!0100187".....Last time save value is "187".

8-9. Read digital input latched

Command	#IDLS(CHK)(cr)	
Syntax Description	\$	First leading code
	ID	Address of setting module 00~FF(HEX)
	L	Read digital input latch
	S	S=0 Latch logic 0 S=1 No use
	CHK	Checksum
	(cr)	Carriage return
Response	!IDABCD(CHK)(cr)	ACD:No use B:DI0~DI7 latch status
	?ID(CHK)(cr)	Command Invalid

Example:

Send command: "\$01L0".....Read digital input logic 0.

Response: "!010200 "..... DI1 have been latched.

*Digital input latch: User key in a digital signal to the module and want to read the response of key stroke. However the user will lost the stroke information because the key input is pulse digital

input. If user read by the command "\$ID6" in time A and time B, the response is that no key stroke. Use command \$IDLS can solve this problem, user may read the key stroke in time position A and B.

8-10. Clear digital input latched

Command	\$IDC(CHK)(cr)	
Syntax description	\$	First leading code
	ID	Address of setting module 00-FF (HEX)
	C	Clear digital input latch
	CHK	Checksum
	(cr)	Carriage return
Response	!ID(CHK)(cr)	Command valid
	?ID (CHK)(cr)	Command Invalid

Example:

Send command: "\$01C".....Clear digital input latch .

Response: "!01 ".....Latch have been clear.

8-11. Read digital input/output status

Command	\$ID6(CHK)(cr)	
Syntax Description	\$	First leading code
	ID	Address of setting module 00~FF(HEX)
	6	Read digital /output status
	CHK	Checksum
	(cr)	Carriage return
Response	!IDABCD(CHK)(cr)	AB:DO0~DO7 output status ,CD::DI0~DI7 output status
	?ID(CHK)(cr)	Command Invalid

Example:

Send command: \$016.....Read digital I/O status .

Response: "!0121CF"....."21": Output DO0,DO5 enable.

"CF": Input DI4,DI5 enable.

8-12. Read the TRP-C29U configuration

Command	\$ID2(CHK)(cr)	
Syntax	\$	First leading code
	ID	Address of setting module 00~FF(HEX)
Description	2	Read configuration
	CHK	Checksum
	(cr)	Carriage return
Response	!IDPPBDD(CHK)(cr)	Command valid PP: Digital I/O type=40 BB: Baud rate DD=Data format (See data format table) Module model BIT0~2="000":TRP-C28 "001" TRP-C24 "010" TRP-C26 "011" TRP-C29U
	?ID(CHK)(cr)	Command Invalid

Example:

Send command:\$012...Read configuration .

Response:"! 01400603"..... DIO type=40,Baud-Rate=9600 (See 7.2) ,Data format=03 Input counter :rising ,Checksum= disable, Model=3....TRP-C29UM.

8-13. Reset

Command	\$IDRS(CHK)(cr)	
Syntax	\$	First leading code
	ID	Address of setting module 00~FF(HEX)
Description	RS	Reset the TRP-C29U module
	CHK	Checksum
	(cr)	Carriage return
Response	!ID(CHK)(cr)	Command valid
	?ID(CHK)(cr)	Command Invalid

Example:

Send command:"\$01RS".....Reset TRP-C29UM.

Response:"!01 ".....Have been reset.

8-14. Read the module's name

Command	\$IDM(CHK)(cr)	
Syntax description	\$	First leading code
	ID	Address of setting module 00-FF(HEX)
	M	Reading TRP-C28's name
	CHK	Checksum
	(cr)	Carriage return
Response	!IDNNNNNN(CHK)(cr)	NNNNNN :The chars from 1 -6 chars
	?ID(CHK)(cr)	Command Invalid

Example:

Send command:\$01M...Read the TRP-C29UM's name.

Response:"!01TRPC29..... The module's name is "TRPC29.

8-15.Read the module's firmware version

	\$IDF(CHK)(cr)	
Syntax description	\$	First Leading code
	ID	Address of setting module 00-FF(HEX)
	F	Command for leading module's version
	CHK	Checksum
	(cr)	Carriage return
Response	!IDMODYYMMDD	Mod: The module type YY: Year MM: Month DD: Date
	?ID(CHK)(cr)	

Example:

Send command:"\$01F"...Read the TRP-C29UM's version.

Response:"!01C29M0703 The TRP-C29UM's version date is "11/06/2009".

8-16. Read the module reset status

Command	\$ID5(CHK)(cr)	
Syntax description	\$	First leading code
	ID	Address of setting module 00-FF (HEX)
	5	Command for reading reset status
	CHK	Checksum
	(cr)	Carriage return
Response	!IDS(CHK)(cr)	S=1 has been reset S=0 not been reset
	?ID(CHK)(cr)	Command Invalid

Example:

Send command:\$015...Read the TRP-C29UM's reset state .

Response:"!011"..... The TRP-C29UM has been reset.

*If the module is system halt or detect abnormal voltage, the module will restart and reset the flag to "1".

8-17.Change the module's name

Command	~IDONN(CHK)(cr)	
Syntax description	~	First leading code
	ID	Address of setting module 00-FF (HEX)
	O	Command for rename TRP-C28's name
	NN	NN:TRP-C28's name, Max.6 characters
	CHK	Checksum
	(cr)	Carriage return
Response	IID(CHK)(cr)	Command valid
	?ID(CHK)(cr)	Command Invalid

Example:

Send command:"~01OABCDE"..... Change the TRP-C29UM's name become to "ABCDE".

Response:"!01"..... . Command valid.

Then send the command "\$01M"...read the TRP-C29UM's name.

Response:"!01ABCDE"..... .The TRP-C29UM's name is "ABCDE".

8-18. Set the module's LED operating mode

Command	~IDLEDA(CHK)(cr)	
Syntax description	~	First Leading code
	ID	Address of setting module 00-FF(HEX)
	A	A=0 Turn on all LED when DIO enable off. A=1 Turn off all LED when DIO enable on.
	CHK	Checksum
	(cr)	Carriage return
Response	!IDON/OFF	Command valid
	?ID(CHK)(cr)	Command invalid

Example:

Send command: "~01LED0"..... Turn off all LED, when logic "1" ON.

Response: "!01OFF".....Command valid.

8-19. Enable watchdog and set the timeout value

Command	~IDWENN(CHK)(cr)	
Syntax description	~	First leading code
	ID	Address of setting module 00-FF(HEX)
	WE	Watchdog Enable
	NN	Set the watchdog time(NN:00-FF) One Unit=0.1 Sec FF: MAX. 25.5 Sec
	(cr)	Carriage return
Response	!ID(CHK)(cr)	Command valid
	?ID(CHK)(cr)	Command Invalid

Example:

Send Command: "~01WEFF"..... Set the watchdog time for 25.5 Sec.

Response: "!01"..... . Command valid, When module count to 25.5 Sec the watchdog will into safe mode ,then PWR LED will flash, before timeout if host send "~**", the watchdog will re-counted!.

Send Command: "~01WE00"..... Set the watchdog disable.

Response: "!01"..... . Command valid

*When the module is in safe mode, any digital output command are invalid, you will get the response "!IDWE" , which means the system is in safe mode, you can't change output status.

*Reset and power fail will not affect watchdog mode.

8-20. Disable watchdog

Command	~IDWD(CHK)(cr)	
Syntax description	~	First leading code
	ID	Address of setting module 00-FF (HEX)
	WD	Disable watchdog
	(cr)	Carriage return
Response	!ID(CHK)(cr)	Command valid
	?ID(CHK)(cr)	Command Invalid

Example:

Send Command: "~01WD"..... Watchdog disable!

Response: "!01"..... . Command valid, System LED will stop flashing!

8-21. Read watchdog timeout value

Command	~IDWR(CHK)(cr)	
Syntax description	~	First leading code
	ID	Address of setting module 00-FF (HEX)
	WR	Read watchdog timeout value
	CHK	Checksum
	(cr)	Carriage return
Response	!IDWANN (CHK)(cr) !ID (CHK)(cr)	W: watchdog A=E: watchdog enable D: watchdog disable or safe mode NN: watchdog timeout value
	?ID(CHK)(cr)	Command Invalid

Example:

Send Command: "~01WR".... Read watchdog timeout value.

Response: " !01WD0F"..... . Command valid, set the watchdog timeout is "0F"..1.6 Sec.

8-22. System stand by (Host OK!)

Command	~**(CHK)(cr)	
Syntax description	~	First leading code
	**	Host ok!
	CHK	Checksum
	(cr)	Carriage return
Response	No Response	



Before watchdog timeout, Send the Host ok ! NN: Watchdog timeout value

*If watchdog is in enable , send the Host Ok!"command before watchdog timeout (B) the watchdog will re-count, PWR LED will flashing after watchdog timeout.

8-23.Read power on/safe value

Command	~ID4V(CHK)(cr)	
Syntax description	~	First Leading code
	ID	Address of setting module 00-FF(HEX)
	4	Read power on or safe mode I/O status
	V	V=P: Power on mode I/O status V=S: Safe mode I/O status
	CHK	Checksum
	(cr)	Carriage return
Response	!IDABCD	AB=DO0~DO7 CD=DI0~DI7
	?ID(CHK)(cr)	Command invalid

Example:

Send Command:~014S.....Read safe mode digital output status.

Response:" !01080F"..... Command valid, safe mode digital IO status is "080F".

8-24. Save current digital output status to power on or safe mode

Command	~ID5V(CHK)(cr)	
Syntax description	~	First leading code
	ID	Address of setting module 00-FF (HEX)
	5	Save the current digital output is safe or power on mode
	V	V=P Power On V=S Safe value
	(cr)	Carriage return
Response	IID (CHK)(cr)	Command valid
	?ID(CHK)(cr)	Command Invalid

Example:

Send Command: "#010013"...set up digital output CH7~CH0" to "0001 0011"

Response: " !01"..... . Command valid!

Then Send Command : " ~015P"....Set the power on mode ,After power fail or reset , The module will load current DO status.

8-25. Save current digital input /output status

Command	#*(CHK)(cr)	
Syntax description	#	First leading code
	**	Save current digital IO status(All modules on line).
	CHK	Checksum
	(cr)	Carriage return
Response	No Response	

Example:

Send Command: "#**"..... Save current digital IO status of all modules on line.

8-26. Read synchronized data

Command	\$ID4(CHK)(cr)	
Syntax description	\$	First leading code
	ID	Address of setting module 00-FF(HEX)
	4	Read synchronized data
	CHK	Checksum
	(cr)	Carriage return
Response	IABCDE00(CHK)(cr)	Command valid A=1:Have been send"###" A=0:Have been read BC: Digital output status DE: Digital input status
	?ID	Before send this command do not send the command "###"

Example:

Send Command:"###".....Save current digital IO status(All modules on line).

Then send command:"\$014".... Read synchronized data

Response:"!1010E00"...."1":Have been send the "###",the DIO status valid is "010E" *After Read

*synchronized data ,A value is "1", Read again become to "0".

9. Modbus/RTU Command Description

The TRP-C29U support Modbus/RTU protocol, The serial communication data format is

Start bit: 1

Data bit: 8

Parity check: None

Stop bit: 1

Baud-rate: 1200bps~115200bps.

9-1. Modbus Syntax:

Command Format :ID(HEX)+FC(HEX)+SU(HEX)+DA(HEX) or RC(HEX)+CRC16(HEX).

Response Format : ID(HEX)+FC(HEX)+SU(HEX)+DA(HEX) or RC(HEX)+CRC16(HEX).

Error Format: ID(HEX)+ FC(HEX)+ CRC16(HEX).

ID: RS485 Device Address (HEX).....1~247 1Byte.

FC: Function Code (HEX)...1 Byte.

SU: Sub Function (HEX).....1 Byte

DA: Data Format....No Limit

RC: Reserved code...No Limit

CRC: Cyclic Redundancy Check...2 Byte

****Error Response: If CRC IS mismatches error the response is empty!***

10. Modbus RTU Command List

Command List	Function Description	Index
ID 46 00 00 (CRC)	Read the module's name	10-1
ID 46 04 IP 00 00 00 (CRC)	Set up the module's address	10-2
ID 46 05 00 (CRC)	Read the module's configuration	10-3
ID 46 06 00 BD 00 00 00 00 00 00 (CRC)	Set up the module's configuration	10-4
ID 46 07 00 (CRC)	Read the module's Firmware	10-5
ID 46 08 00(CRC)	Read module reset status	10-6
ID 46 09 00 (CRC)	Reset	10-7
ID 46 0B WS 00 (CRC)	Set up watchdog timeout value or disable	10-8
ID 46 0C 00 (CRC)	Read watchdog status	10-9
ID 46 0D 0S 00 (CRC)	Set up LED panel status	10-10
ID 46 27 DD 00 (CRC)	Set up power on mode	10-11
ID 46 28 00 (CRC)	Read power on mode value	10-12
ID 46 29 DD 00 (CRC)	Set up safe mode value	10-13
ID 46 2A 00 (CRC)	Read safe mode value	10-14
ID 46 2F 00 (CRC)	System stand by (Host OK!)	10-15
ID 05 SS NN DD 00 (CRC)	Set up single channel and latch status	10-16
ID 01 00 SS 00 08 (CRC)	Read digital input/output status	10-17
ID 03 00 SS 00 NN (CRC)	Read digital input counter value	10-18
ID 04 00 SS 00 NN (CRC)	Read digital input counter value	10-19
ID 0F SS NN 00 CN BC 00 (CRC)	Set up single channel and latch status	10-20

10-1. Read the module's name

Command	ID 46 00 00 (CRC)	
Syntax Description	ID	Address of setting module 1~247
	46	Function code
	00	Read module's name
	00	Reserved code
Response	ID 46 00 00 0C 29 00 (CRC)	ID 46 00 00Module command Line 0C 29 :Module's Name is C29
	ID C6 00(CRC)	ID C6 (CRC) C6:Function Code 00: Reserved code

EX: Send Command:"01 46 00 00".....Read the TRP-C29U's name

Response:"01 46 00 00 0C 29 00 ".....Module's name is C29

Error Response: "01 C6 00".....Error code

10-2. Set up the module's address

Command	ID 46 04 IP 00 00 00 (CRC)	
Syntax Description	ID	Address of setting module 1~247
	46	Function Code
	04	Set up module's ID
	IP	New module's ID
	00 00 00	Reserved code
Response	ID 46 04 00 00 00 00 (CRC)	ID 46 04 00 00 00 00Change module ID OK!
	ID C6 00(CRC)	ID C6 (CRC) C6:Function Code 00: Reserved code

EX: Send Command:"02 46 04 03 00 00 00".....Set up the new ID is "03".

Response:"01 46 04 00 00 00 00 ".....New ID is 03.

Error Response: "01 C6 00".....Error code.

10-3. Read the module's configuration

Command	ID 46 05 00 (CRC)	
Syntax Description	ID	Address of setting module 1~247
	46	Function Code
	05	Read module's configuration
	00	Reserved code
Response	ID 46 05 00 BD 00 00 00 00 00 00 (CRC)	ID 46 05 00Module command Line BD :Baud Rate See 8-2 00 00 00 00 00 00 : Reserved code
	ID C6 00(CRC)	ID C6 (CRC) C6:Function Code 00: Reserved code

Example:

Send Command:"01 46 05 00".....Read TRP-C29U's configuration.

Response:"01 46 05 00 **06** 00 00 00 00 00 00 ".....06:BD=9600...See 8-2 baud rate table.

Error Response: "01 C6 00".....Error code.

10-4. Set up the module's configuration

Command	ID 46 06 00 BD 00 00 00 00 00 00 (CRC)	
Syntax Description	ID	Address of setting module 1~247
	46	Function Code
	06	Set up module's configuration
	00 BD 00 00 00 00 00 00	BD : Baud-Rate....See 8-2
Response	ID 46 06 00 00 00 00 00 00 00 00 (CRC)	ID 46 06 00Module command Line 00 00 00 00 00 00 00 00 : Reserved code
	ID C6 00 (CRC)	ID C6 (CRC) C6:Function Code 00: Reserved code

Example:

Send Command:"01 46 06 00 **0A** 00 00 00 00 00 00".....Set up TRP-C29U's configuration.

Response:"01 46 06 00 00 00 00 00 00 00 "....Set up OK!

Error Response: "01 C6 00".....Error code. *Baud-Rate set to 115200

10-5. Read the module's Firmware

Command	ID 46 07 00 (CRC)	
Syntax Description	ID	Address of setting module 1~247
	46	Function Code
	07	Read module's Firmware
	00	Reserved code
Response	ID 46 07 YY MM DD 00(CRC)	ID 46 07Module command Line YY:Year MM :Month DD:Date 00 : Reserved code
	ID C6 00 (CRC)	ID C6 (CRC) C6:Function Code 00: Reserved code

Example:

Send Command: "01 46 07 00"Set up TRP-C29U's configuration.

Response: "01 46 07 09 07 03 00" ...JUY. 03.2009 TRP-C29U Firmware Version.

Error Response: "01 C6 00"Error code.

10-6. Read module reset status

Command	ID 46 08 00(CRC)	
Syntax Description	ID	Address of setting module 1~247
	46	Function Code
	08	Read Module Reset status
	00	Reserved code
Response	ID 46 08 0D 00 (CRC)	D=0 Have been read, D=1 Have been reset
	ID C6 00 (CRC)	ID C6 (CRC) C6:Function Code 00: Reserved code

Example:

Send Command: "01 46 08 00" ...Read the module's digital input status.

Response: "01 46 08 1 00 ..have been reset.

10-7.Reset

Command	ID 46 09 00 (CRC)	
Syntax Description	ID	Address of setting module 1~247
	46	Function Code
	09	Module Reset
	00	Reserved code
Response	ID 46 09 00 (CRC)	Command valid
	ID C6 00 (CRC)	ID C6 (CRC) C6:Function Code 00: Reserved code

Example:

Send Command:"01 46 09 00"...Read the module's digital input status.

Response:"01 46 09 00 ..Command valid.

Error Response: "01 C6 00"...Error code.

10-8.Set up watchdog timeout value or disable watchdog

Command	ID 46 0B WS 00 (CRC)	
Syntax Description	ID	Address of setting module 1~247
	46	Function Code
	0B	Set up watchdog function
	WS	WS=00 Watchdog Disable Watchdog timer from 01~FF (100ms~25.5 Sec)
	00	Reserved code
Response	ID 46 0B 00(CRC)	00 ID 46 0B 00Command valid
	ID C6 00 (CRC)	ID C6 (CRC) C6:Function Code 00: Reserved code

Example:

Send Command:"01 46 0B 05 00".....Set up TRP-C29U's watchdog timer=500ms.

Response:"01 46 0B 00"...Command valid .

Error Response: "01 C6 00".....Error code.

10-9. Read watchdog status

Command	ID 46 0C 00 (CRC)	
Syntax Description	ID	Address of setting module 1~247
	46	Function Code
	0C	Read watchdog value
	00	Reserved code
Response	ID 46 0C WT (CRC)	ID 46 0CModule command line WT: Watch dog value
	ID C6 00 (CRC)	ID C6 (CRC) C6:Function Code 00: Reserved code

Example:

Send Command: "01 46 0C 00" ... Read TRP-C29U's watchdog value.

Response: "01 46 0C 01 0F."

Error Response: "01 C6 00" ... Error code.

10-10. Set up LED panel status

Command	ID 46 0D 0S 00 (CRC)	
Syntax Description	ID	Address of setting module 1~247
	46	Function Code
	0D	Set Up LED Status Value
	0S	S = 0 Turn on all LED when DIO enable off S = 1 Turn off all LED when DIO enable on
	00	Reserved code
Response	ID 46 0D 00 (CRC)	ID 46 0DModule command line
	ID C6 00 (CRC)	ID C6 (CRC) C6:Function Code 00: Reserved code

Example:

Send Command: "01 46 0D 01 00."

Response: "01 46 0D 00."

Error Response: "01 C6 00" ... Error code.

10-11. Set up power on mode

Command	ID 46 27 DD 00 (CRC)	
Syntax Description	ID	Address of setting module 1~247
	46	Function Code
	27	Set up power on mode
	DD	Digital output power on value
	00	Reserved code
Response	ID 46 27 00(CRC)	00 ID 46 27 00Command valid
	ID C6 00 (CRC)	ID C6 (CRC) C6:Function Code 00: Reserved code

Example:

Send Command:"01 46 27 01 00".....Set up TRP-C29U's power on value.

Response:"01 46 27 00"...Command valid.

Error Response: "01 C6 00".....Error code.

Then send "01 46 09 00"After reset will get power on DD value

10-12.Read power on mode value

Command	ID 46 28 00 (CRC)	
Syntax Description	ID	Address of setting module 1~247
	46	Function Code
	28	Read power on value
	00	Reserved code
Response	ID 46 28 DD (CRC)	00 46 28Module command line DD: Power on value
	ID C6 00 (CRC)	ID C6 (CRC) C6:Function Code 00: Reserved code

Example:

Send Command:"01 46 28 00".....Read TRP-C29U's power on value.

Response:"01 46 28 08 "...Power on DO status DO7~DO0 is "00010011".

Error Response: "01 C6 00".....Error code.

***Power on mode: Digital output states when power on.**

10-13.Set up safe mode value

Command	ID 46 29 DD 00 (CRC)	
Syntax Description	ID	Address of setting module 1~247
	46	Function Code
	29	Set up safe mode value
	DD	DD: Safe mode digital output value
	00	Reserved code
Response	ID 46 29 00(CRC)	ID 46 29 00Command valid.
	ID C6 00 (CRC)	ID C6 (CRC) C6:Function Code 00: Reserved code

Example:

Send Command:"01 46 29 14 00".....Set up TRP-C29U's safe mode value.

Response:"01 46 29 00".

Then send "01 46 0B 12 00".....Waiting the watchdog timeout until the digital output value become "14".

Error Response: "01 C6 00".....Error code.

***Safe mode: Digital output states when watchdog timeout.**

10-14.Read safe mode value

Command	ID 46 2A 00 (CRC)	
Syntax Description	ID	Address of setting module 1~247
	46	Function Code
	2A	Read power on mode
	00	Reserved code
Response	ID 46 2A DD (CRC)	00 46 2A 00Module command line DD : Safe mode value
	ID C6 00 (CRC)	ID C6 (CRC) C6:Function Code 00: Reserved code

Example:

Send Command:"01 46 2A 00".....Read TRP-C24's safe mode value.

Response:"01 46 2A 12 "...Safe mode value is "12".

Error Response: "01 C6 00".....Error code.

10-15. System stand by (Host OK!)

Command	ID 46 2F 00 (CRC)	
Syntax Description	ID	Address of setting module 1~247
	46	Function Code
	2F	System stand by
	00	Reserved code
Response	No Response	

10-16. Set up single channel and latch status

Command	ID 05 SS NN DD 00 (CRC)	
Syntax Description	ID	Address of setting module 1~247
	05	Function Code
	SS	SS = 00 Set up single channel output SS= 01 ->Clear latch status (NN=0, DD=0) SS= 02 ->Clear single channel counter value(DD=00)
	NN	NN=00~07=DO0~DO7
	DD	Digital output value DD=00 disable, DD=FF enable
	00	Reserved code
	Response	ID 05 SS NN DD 00 (CRC)
ID 85 FF (CRC)		Watchdog mode status
ID 85 ER (CRC)		ID 85 :Error Code ER=00 Syntax error ER=01 Data Format error ER=02 Start channel error ER=03 I/O out of range

***Set up Single-Channel mode (Output control for 1 Bit).**

Example:

Send command :” 01 05 00 03 FF 00 ”.....Set up the DO3 on.

Response:”01 05 00 03 FF 00 ”..... Command valid.

Send command :” 01 05 00 02 00 00 ”.....Set up the DO2 off.

Response:” 01 05 00 02 00 00 ”..... Command valid.

***When the module is in safe mode, any digital output command are invalid, you will get the response “ID 8F FF”, which means the module is in safe mode, you can't change output status Until the watchdog disable.**

***Reset and power fail will not affect watchdog mode.**

10-17.Read digital input/output status

Command	ID 01 00 SS 00 08 (CRC)	
Syntax Description	ID	Address of setting module 1~247
	01	Function Code
	00	Start channel number
	SS	SS=00 Read DO status SS=20 Read DI status SS=40 Latch low SS=60 Latch High
	00 08	Output channel number
Response	ID 01 BC DD (CRC)	ID 01 :Command Line BC: Byte counter DD: DIO Status
	ID 81 ER (CRC)	ID 81 :Function Code ER=00 Syntax error ER=01 Data Format error ER=02 Start channel error ER=03 I/O out of range

Example:

Send command :” 01 01 00 00 00 08 ”.....Read DO status.

Response:” 01 01 01 36 ”..... CH1~2 =on,CH4~5=on.

Send command :” 01 01 00 20 00 08 ”.....Read DI status.

Response:” 01 01 01 DF ”..... CH5 Enable.

Send command :” 01 01 00 40 00 8 ”.....Read Latch Low.

Response:” 01 01 01 01 ”..... bit0 have been triger.

10-18. Read digital input counter value

Command	ID 03 00 SS 00 NN (CRC)	
Syntax	ID	Address of setting module 1~247
	03	Function Code
Description	00 SS	Start channel number SS=00
	00 NN	Channel number NN=01~08
Response	ID 03 BC DATA (CRC)	ID 03Module command Line BC: Byte Counter ,Each channel 2byte DATA :Channel counter value
	ID 83 ER (CRC)	ID 83 :Error Code ER=00 Syntax error ER=01 Data Format error ER=02 Start channel error ER=03 I/O out of range

10-19. Read digital input counter value

Command	ID 04 00 SS 00 NN (CRC)	
Syntax	ID	Address of setting module 1~247
	04	Function Code
Description	00 SS	Start channel number SS=00
	00 NN	Channel number NN=01~08
Response	ID 04 BC DATA (CRC)	ID 04Module command Line BC: Byte Counter ,Each channel 2byte DATA :Channel counter value
	ID 84 ER (CRC)	ID 84 :Error Code ER=00 Syntax error ER=01 Data Format error ER=02 Start channel error ER=03 I/O out of range

Example:

Send command : "01 04 00 00 00 04".....Read channel 0~3 counter value.

Response:" 01 04 08 **00 28** 00 5A **00 53** 00 55" Command valid.

CH0=28,CH1=5A,CH2=53,CH3=55.

10-20.Clear/save DI counter value and set up DO output

Command	ID 0F SS NN 00 CN BC 00 (CRC)	
Syntax Description	ID	Address of setting module 1~247
	0F	Function Code
	SS	SS=00 Digital Output SS=02 Clear Counter value SS=03 Save Counter value to EEPROM
	NN	Start channel number NN=00~07
	00 CN	Channel number 1~8
	BC	Byte Counter=01
	00	Output value
Response	ID 0F SS NN 00 00 (CRC)	Command Valid
	ID 8F ER (CRC)	ID 85 :Function Code ER=00 Syntax error ER=01 Data Format error ER=02 Start channel error ER=03 I/O out of range

Example:

Send command :” 01 0F 00 00 00 08 01 25 ”.....Set up the digital output valid.

Response:” 01 0F 00 00 00 08 ” set up the CH0,CH2,CH5 Enable.

Send command :” 01 0F 02 04 00 04 01 00 ”.....Clear channel counter from CH4~CH7 to EEPROM

Response:” 01 0F 02 00 00 0F ” Command valid.

Send command :” 01 0F 03 00 00 08 01 00 ”.....Save channel counter from CH0~CH7 to EEPROM

Response:” 01 0F 03 00 00 08 ” Command valid.

*When the module is in safe mode, any digital output command are invalid, you will get the response “ID 8F FF”, which means the module is in safe mode, you can't change output status Until the watchdog disable.

*Reset and power fail will not affect watchdog mode.

11. How to use the utility for windows

The TRPCOM utility can help you to test and configuration the module's data transmit and receive digital input and output communication status. User may download TRPCOM software from TRYCOM web www.trycom.com.tw.

1.The "Setting"function is for user to initiate the software to set the Com Port from 1 to 20 and setting the Baud-Rate from 1200 to 115200,Checksum Enable or Disable. ...See Figure 1

*The Module Factory Setting is "9600" and "ID" is 01, Checksum is Disable.

*Turn module's switch to "OFF,ON" position into ASCII communication mode.

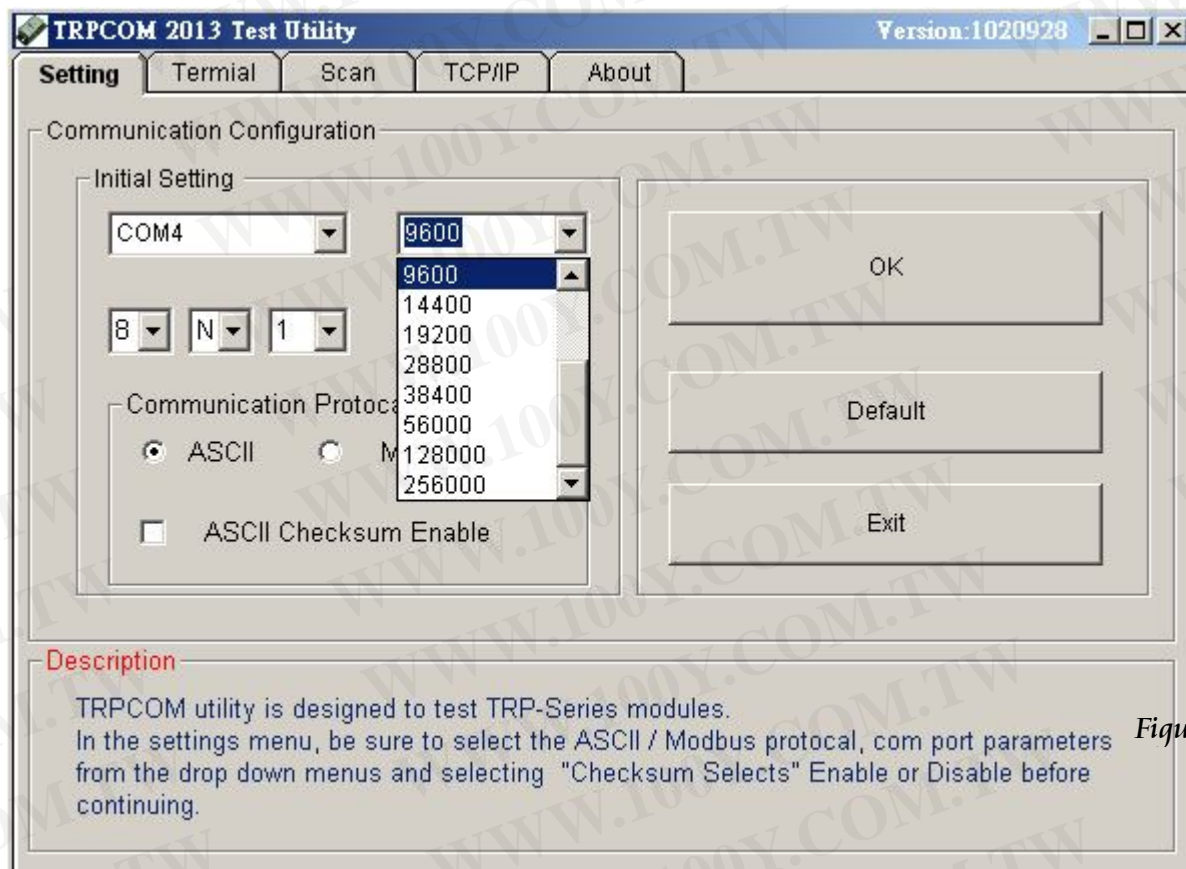

Figure 1

2.The "Terminal" function is for user to input command, user can control all of module's digital input/output status or wait to get module response status ...See Figure 2.

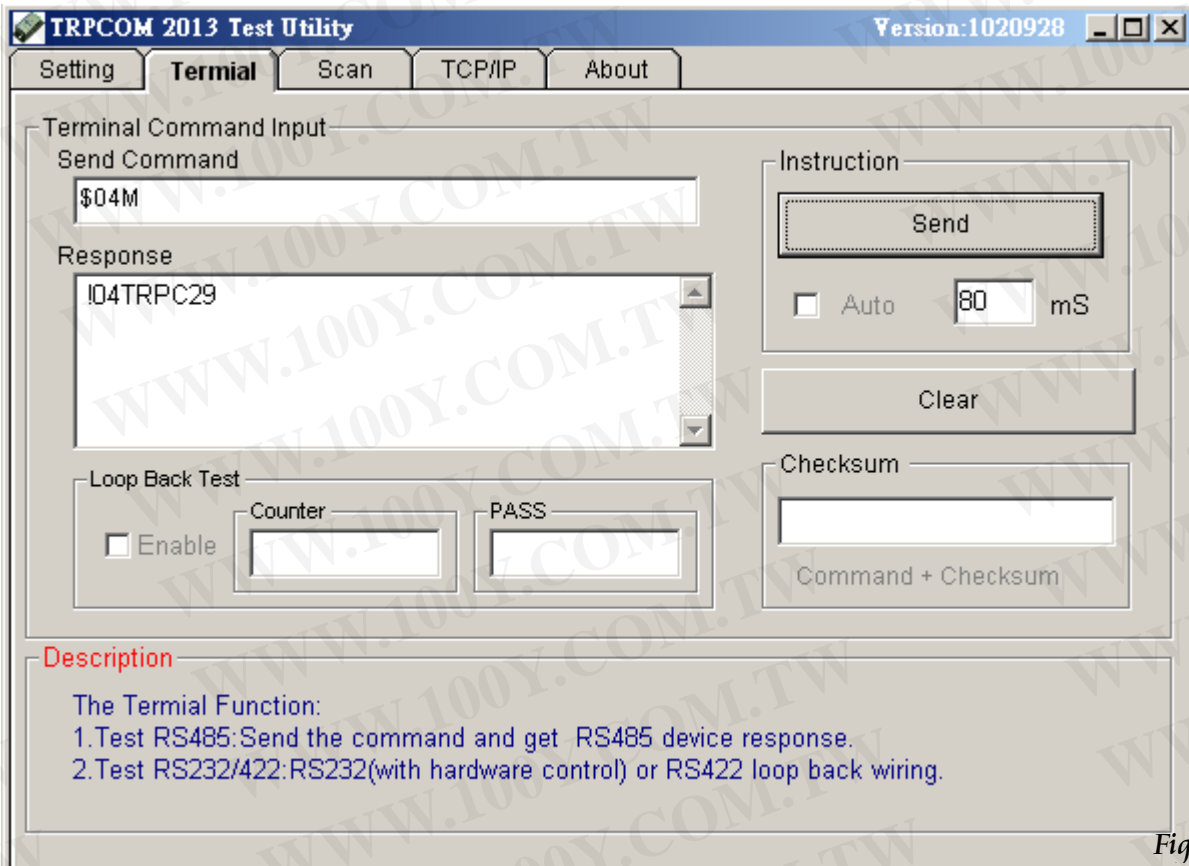
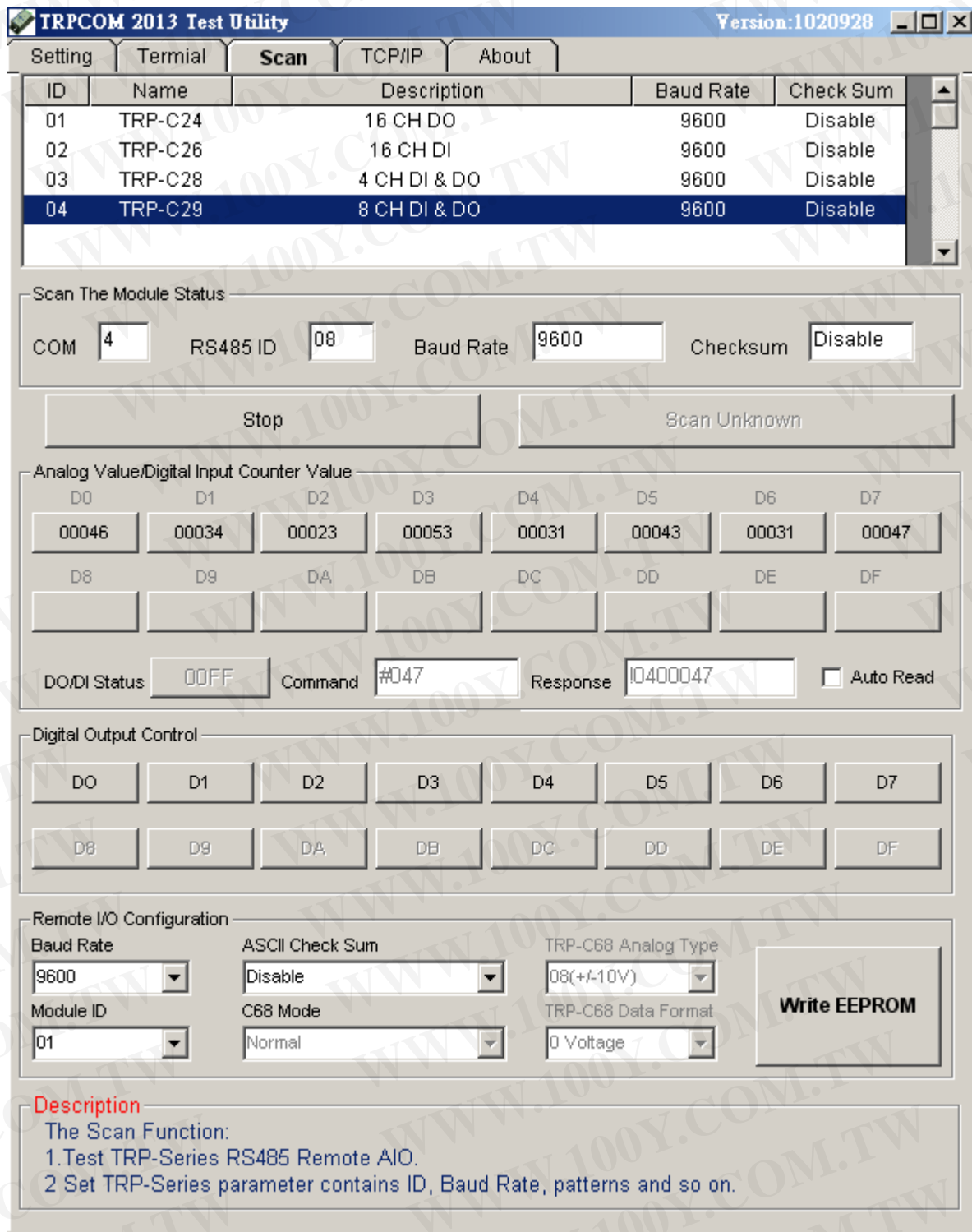

Figure 2

If you don't know the module's ID may select "Scan" to find the module's setting.



Select the module which one you want setting then click.

Example: TRP-C29 Configuration

A: Get Counter Value please click Digital Input “D0~D7” button.

B: Enable the digital output click Digital Output “D0~D7”button.

C: Set up new RS485 ID, Baud-Rate and data format then click “Write to EEPROM” button.

12. Application

